

**SERIES:** PCSA1-S | **DESCRIPTION:** DC-DC CONVERTER

**FEATURES**

- up to 1 W isolated output
- industry standard SIP package
- nominal input voltages: 5, 12, 24 Vdc
- single unregulated output
- 1,000 Vdc isolation voltage
- low ripple and noise
- -40 to 100°C
- efficiency up to 82%



MODEL	input voltage		output voltage (Vdc)	output current		output power max (W)	ripple & noise <sup>1</sup> max (mVp-p)	efficiency typ (%)
	typ (Vdc)	range (Vdc)		min (mA)	max (mA)			
PCSA1-S5-S5-S	5	4.5~5.5	5	0	200	1	100	79
PCSA1-S5-S12-S	5	4.5~5.5	12	0	84	1	100	79
PCSA1-S5-S15-S	5	4.5~5.5	15	0	67	1	100	80
PCSA1-S12-S5-S	12	10.8~13.2	5	0	200	1	100	81
PCSA1-S12-S12-S	12	10.8~13.2	12	0	84	1	100	81
PCSA1-S12-S15-S	12	10.8~13.2	15	0	67	1	100	82
PCSA1-S24-S5-S	24	21.6~26.4	5	0	200	1	100	80
PCSA1-S24-S12-S	24	21.6~26.4	12	0	84	1	100	80
PCSA1-S24-S15-S	24	21.6~26.4	15	0	67	1	100	81

Notes: 1. At full load, nominal input, 20 MHz bandwidth oscilloscope, with a 0.33  $\mu$ F ceramic capacitor on the output.  
 2. Required to add a 2.2  $\mu$ F (5 & 12 Vdc input models) or 4.7  $\mu$ F (24 Vdc input models) ceramic capacitor to the input to reduce input voltage stress.  
 3. All specifications are measured at  $T_a=25^\circ\text{C}$ , nominal input voltage, and rated output load unless otherwise specified.

**PART NUMBER KEY**

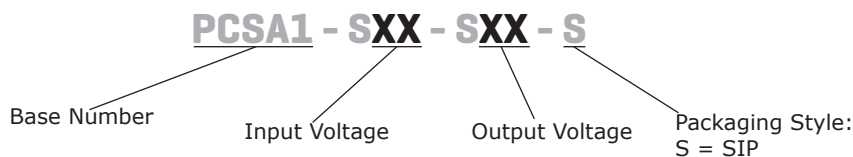

## INPUT

parameter	conditions/description	min	typ	max	units
operating input voltage	5 Vdc input models	4.5	5	5.5	Vdc
	12 Vdc input models	10.8	12	13.2	Vdc
	24 Vdc input models	21.6	24	26.4	Vdc
surge voltage	for maximum of 100 ms				
	5 Vdc input models			9	Vdc
	12 Vdc input models			18	Vdc
	24 Vdc input models			30	Vdc
current	5 Vdc input models		250		mA
	12 Vdc input models		105		mA
	24 Vdc input models		55		mA
filter	capacitive				
input reverse polarity protection	no				
input fuse	0.5 A time delay fuse for all models (recommended)				

Notes: 1. Required to add a 2.2  $\mu$ F (5 & 12 Vdc input models) or 4.7  $\mu$ F (24 Vdc input models) ceramic capacitor to the input to reduce input voltage stress.

## OUTPUT

parameter	conditions/description	min	typ	max	units
maximum capacitive load	at full load			220	$\mu$ F
voltage accuracy				$\pm 3.0$	%
line regulation	1.0% change in input voltage			$\pm 1.2$	%
load regulation	from 100% to 20% load			$\pm 10$	%
switching frequency	at nominal Vin, full load				
	5, 12 Vdc input models		90		kHz
	24 Vdc input models		80		kHz
temperature coefficient				$\pm 0.05$	%/°C

## PROTECTIONS

parameter	conditions/description	min	typ	max	units
short circuit protection	momentary			1	s

## SAFETY AND COMPLIANCE

parameter	conditions/description	min	typ	max	units
isolation voltage	input to output for 1 minute	1,000			Vdc
isolation resistance	input to output	1,000			M $\Omega$
isolation capacitance	input to output		10		pF
conducted emissions	EN 55022 Class A & Class B (external circuit required, see Figure 3)				
MTBF	as per MIL-HDBK-217F, full load, GB, 25°C		1,700,000		hours
RoHS	2011/65/EU				

## ENVIRONMENTAL

parameter	conditions/description	min	typ	max	units
operating temperature	see derating curve	-40		100	°C
storage temperature		-55		125	°C
operating humidity	non-condensing			95	%

## SOLDERABILITY

parameter	conditions/description	min	typ	max	units
wave soldering	see wave soldering profile			260	°C

- Notes:
1. Soldering materials: Sn/Cu/Ni
  2. Ramp up rate during preheat: 1.4°C/s (from 50°C to 100°C)
  3. Soaking temperature: 0.5°C/s (from 100°C to 130°C), 60±20 seconds
  4. Peak temperature: 260°C, above 250°C for 3~6 seconds
  5. Ramp down rate during cooling: -10°C/s (from 260°C to 150°C)

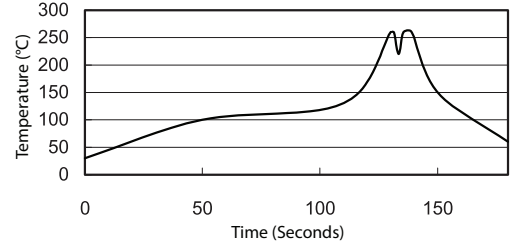

## MECHANICAL

parameter	conditions/description	min	typ	max	units
dimensions	5,12 Vdc input models: 0.46 x 0.24 x 0.40 [11.6 x 6.0 x 10.2 mm] 24 Vdc input models: 0.46 x 0.30 x 0.40 [11.6 x 7.5 x 10.2 mm]				inches inches
case material	non-conductive black plastic				
weight	5, 12 Vdc input models 24 Vdc input models		1.3 1.7		g g

## MECHANICAL DRAWING

units: inches [mm]  
tolerance: X.XX ±0.01 [±0.25]  
pin section tolerance: ±0.002[±0.05]

PIN CONNECTIONS	
PIN	Function
1	-Vin
2	+Vin
3	-Vout
4	+Vout

**5, 12 Vdc input models**

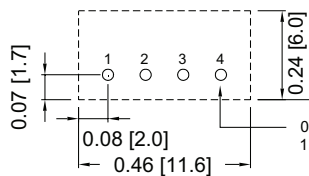
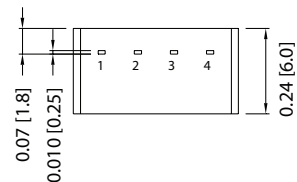
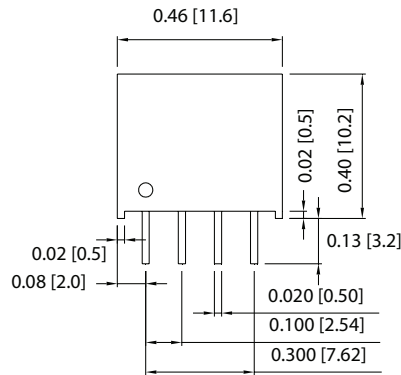

Recommended PCB Layout  
Top View

**24 Vdc input models**

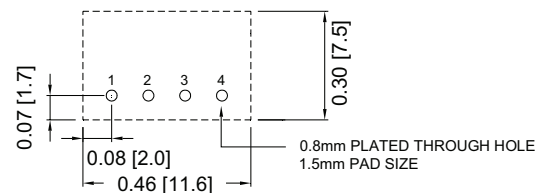
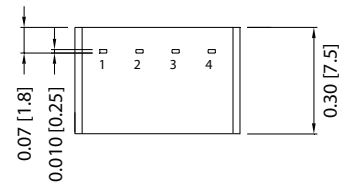
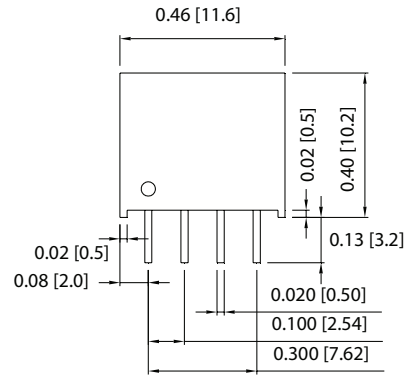

Recommended PCB Layout  
Top View

## DERATING CURVE

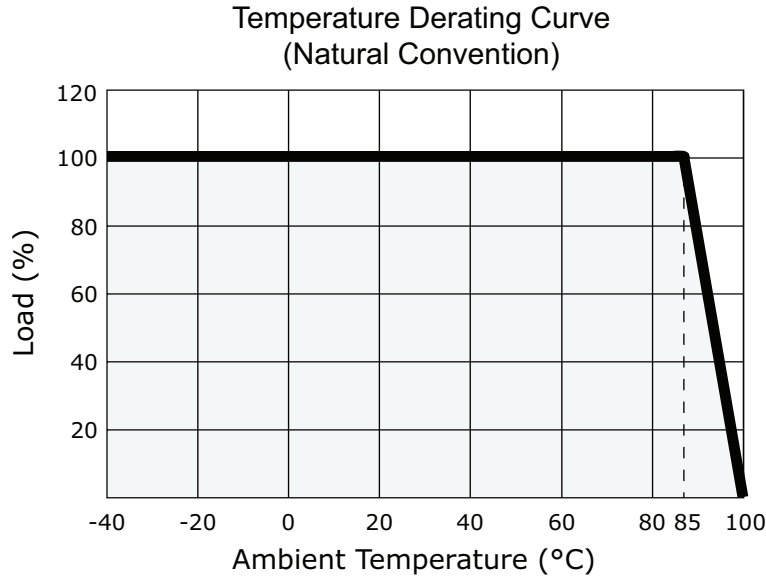

## EFFICIENCY CURVES

PCSA1-S5-S5-S Efficiency Curve  
(Efficiency vs. Line Voltage and Load Current)

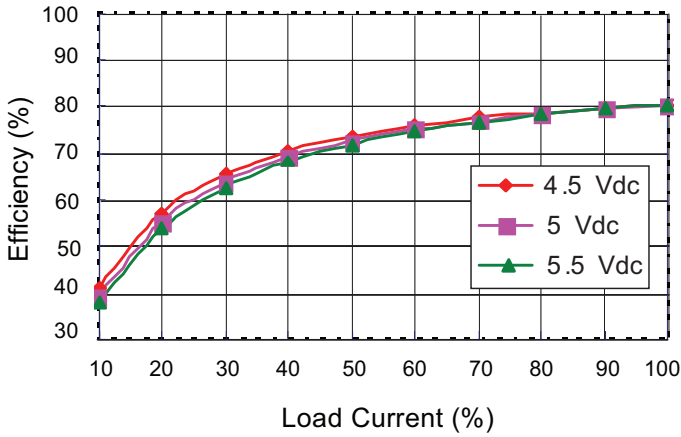

PCSA1-S5-S12-S Efficiency Curve  
(Efficiency vs. Line Voltage and Load Current)

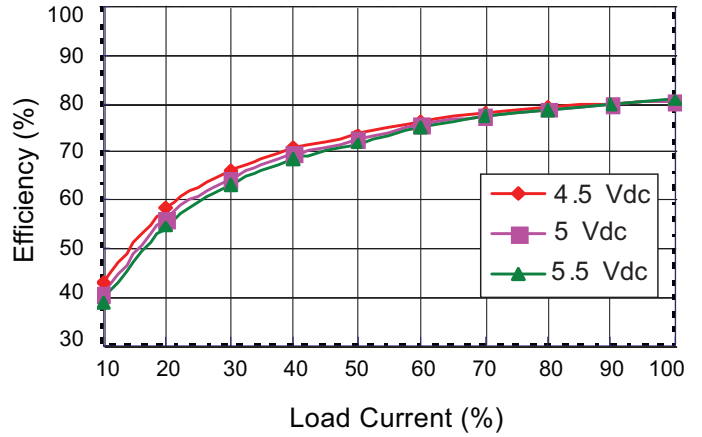

PCSA1-S5-S15-S Efficiency Curve  
(Efficiency vs. Line Voltage and Load Current)

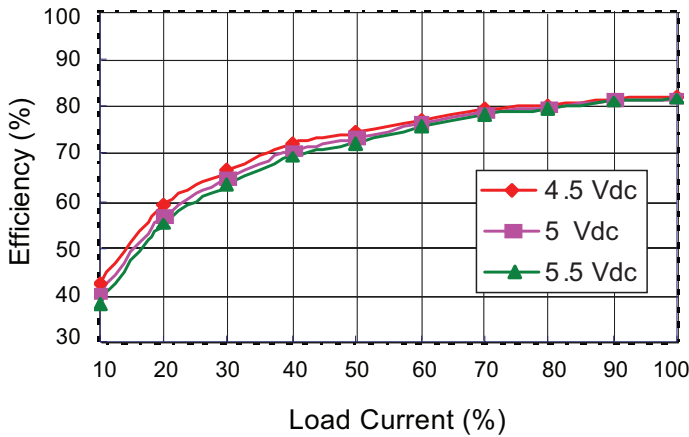

PCSA1-S12-S5-S Efficiency Curve  
(Efficiency vs. Line Voltage and Load Current)

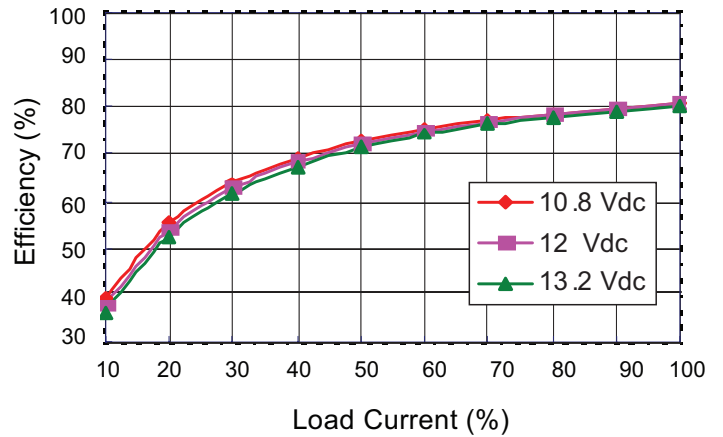

## EFFICIENCY CURVES (CONTINUED)

PCSA1-S12-S12-S Efficiency Curve  
(Efficiency vs. Line Voltage and Load Current)

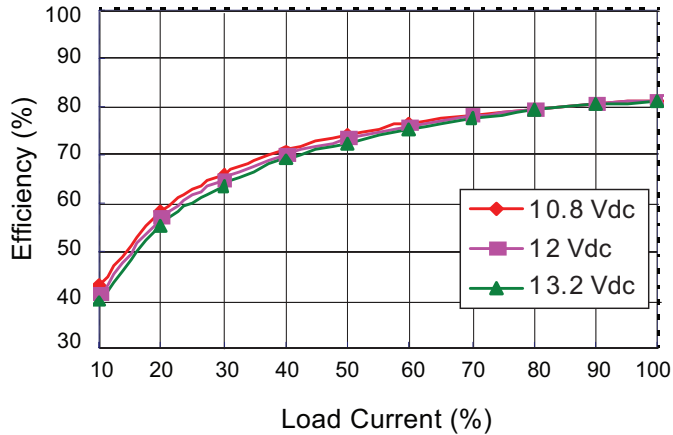

PCSA1-S12-S15-S Efficiency Curve  
(Efficiency vs. Line Voltage and Load Current)

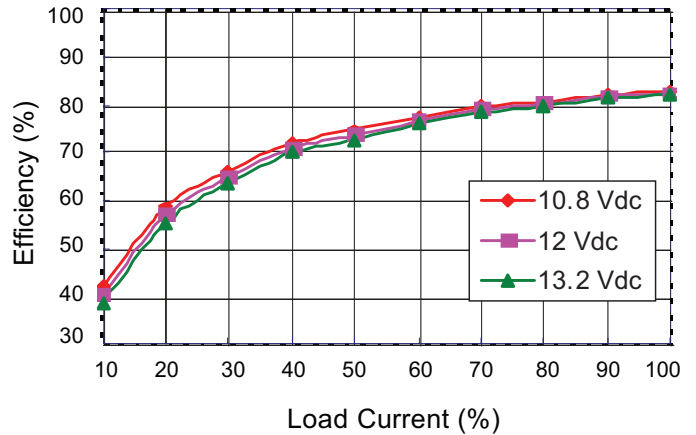

PCSA1-S24-S5-S Efficiency Curve  
(Efficiency vs. Line Voltage and Load Current)

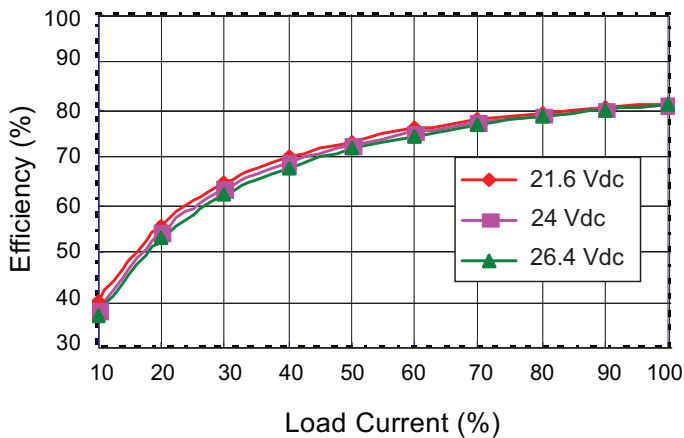

PCSA1-S24-S12-S Efficiency Curve  
(Efficiency vs. Line Voltage and Load Current)

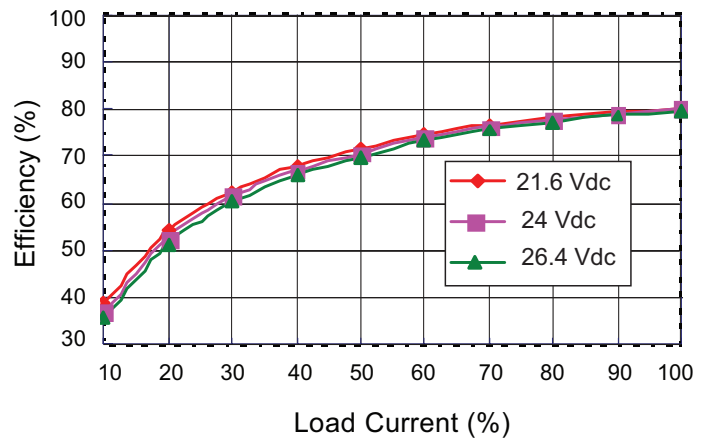

PCSA1-S24-S15-S Efficiency Curve  
(Efficiency vs. Line Voltage and Load Current)

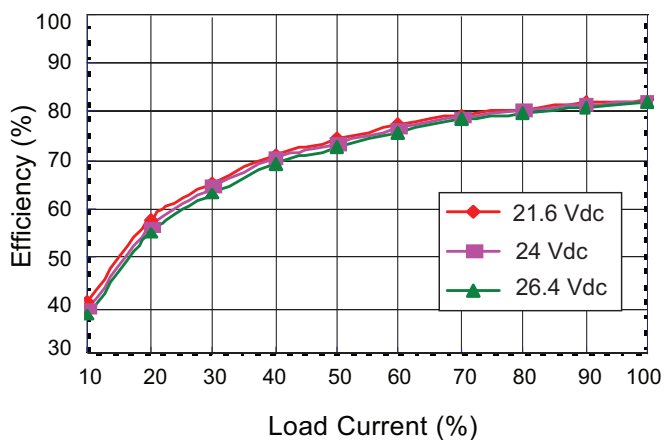

## PACKAGING

### 5, 12 Vdc input models

units: mm

Tube size: 17.2 x 9 x 340 mm

QTY: 26 pcs

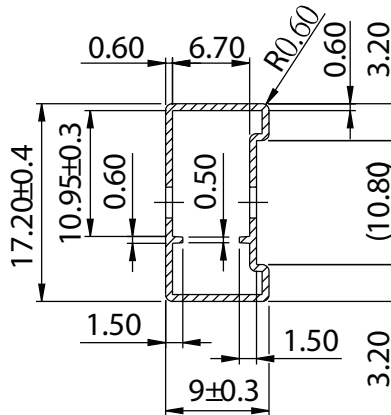

### 24 Vdc input models

units: mm

Tube size: 20 x 11 x 340 mm

QTY: 26 pcs

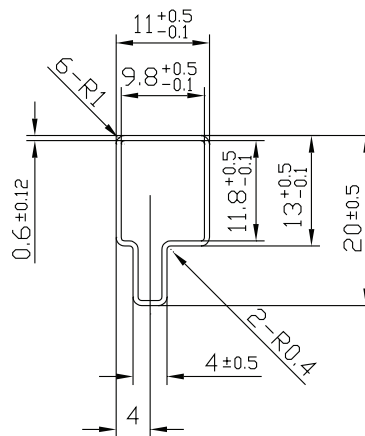

## TEST CONFIGURATIONS

### Input Ripple Current & Output Noise

Figure 1 Measuring Input Ripple Current

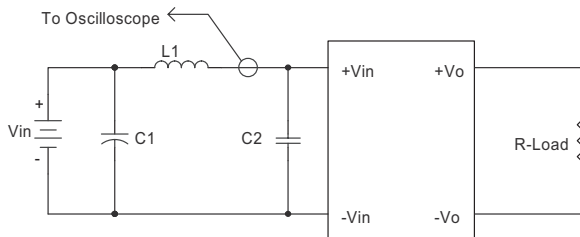

Figure 2 Measuring Output Ripple And Noise

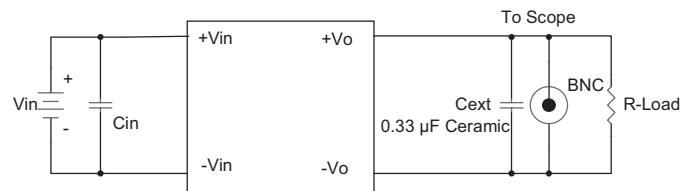

Table 1

Input Voltage (Vdc)	L1	C1	C2
5	12 µH	2.2 µF tantalum capacitor	NC
12	12 µH	2.2 µF tantalum capacitor	NC
24	12 µH	4.7 µF ceramic capacitor	NC

Table 2

Input Voltage (Vdc)	Cin
5	2.2 µF ceramic capacitor
12	2.2 µF ceramic capacitor
24	4.7 µF ceramic capacitor

## EMC RECOMMENDED CIRCUIT

### Test Condition

Input Voltage: Nominal

Output Load: Full Load

**Figure 3 Conducted Emissions Test Circuit**

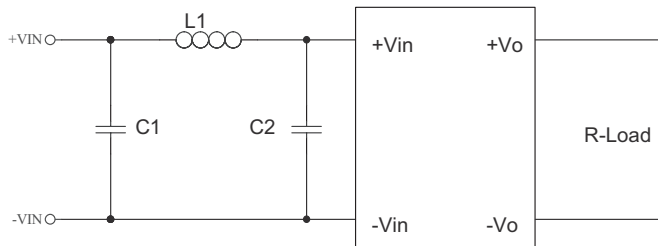

**Table 3**

EN55022 Class A Recommended External Circuit Components		
C1 <sup>1</sup>	C2 <sup>1</sup>	L1
4.7 $\mu$ F / 50 V	4.7 $\mu$ F / 50 V	3.3 $\mu$ H

Notes: 1. Ceramic Capacitor

**Table 4**

EN55022 Class B Recommended External Circuit Components		
C1 <sup>1</sup>	C2 <sup>1</sup>	L1
10 $\mu$ F / 50 V	10 $\mu$ F / 50 V	7.5 $\mu$ H

Notes: 1. Ceramic Capacitor

## REVISION HISTORY

---

rev.	description	date
1.0	initial release	07/26/2016

The revision history provided is for informational purposes only and is believed to be accurate.



**CUI INC<sup>®</sup>**

**Headquarters**  
20050 SW 112th Ave.  
Tualatin, OR 97062  
**800.275.4899**

Fax 503.612.2383  
**cui.com**  
techsupport@cui.com

CUI offers a two (2) year limited warranty. Complete warranty information is listed on our website.

CUI reserves the right to make changes to the product at any time without notice. Information provided by CUI is believed to be accurate and reliable. However, no responsibility is assumed by CUI for its use, nor for any infringements of patents or other rights of third parties which may result from its use.

CUI products are not authorized or warranted for use as critical components in equipment that requires an extremely high level of reliability. A critical component is any component of a life support device or system whose failure to perform can be reasonably expected to cause the failure of the life support device or system, or to affect its safety or effectiveness.