

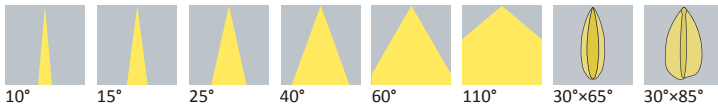

Datasheet

EX Series

Available Distribution



Dimensions

Part Number	Diameter	Height
LL01CR-EXxxL06-M2-T	Ø23	10.63
LL01LU-EXxxL06-M2-T	Ø22.4	9.63
LL01OS-EXxxL06-M2-T	Ø22.4	9.63
LL01ZZ-EXxxL06-M2-T	Ø22.4	9.63
LL01ZZ-EXxxL06-U2-T	Ø22.4	9.63

*All dimensions are in millimeters.

LED

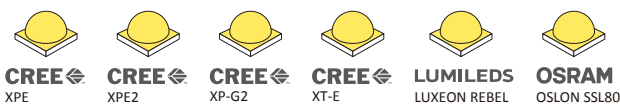

Packaging Details (SPQ)

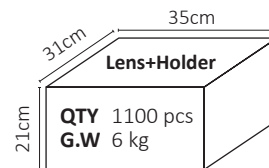

Recommend Applications



General Information



- Lens Material PMMA 8N
- Operating Temperature -40°C~+70°C
- Light Transmission Rate 400nm~900nm > 90%
- ☑ If necessary, Clean lenses with mild soap, water and soft cloth.
- ⚠ Never use any commercial cleaning solvents on lenses, like alcohol.
- 🧤 Please handle or install lenses with wearing gloves, skin oils may damage lens or its optical characteristic.

Accessories



- 5 Different Types of Holder
 - LL01CRNW10H2
 - LL01LUCR60H2
 - LL01OSMZZ5H2
 - LL01ZZCL60H2
 - LL01ZZWB60H2
- Available with Tape LL01A00XGXX

Mechanical Specification

*All dimensions are in millimeters.

Lens Dimension

LL01ZZ-EX××L06

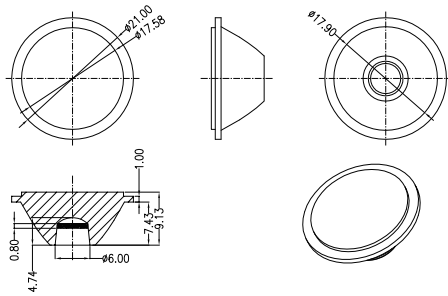

Tape Dimension

LL01A00XGXX

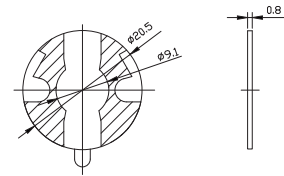

Holder Dimension

LL01CRNW10H2

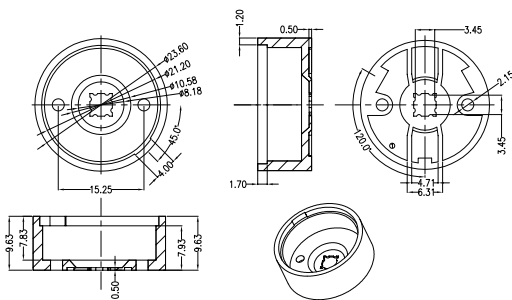

Assembly Instruction

Part No LL01CR-EX××L06-M2-T
Holder LL01CRNW10H2
Tape LL01A00XGXX

Fixing Method

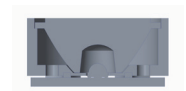
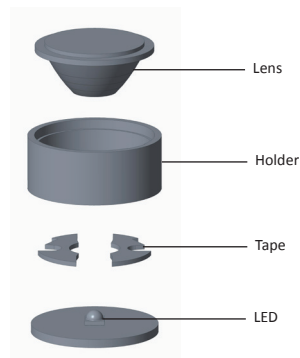

Holder Dimension

LL01LUCR60H2

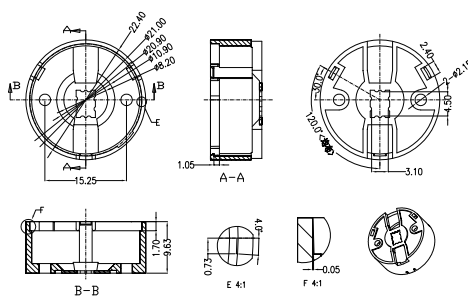

Assembly Instruction

Part No LL01LU-EX××L06-M2-T
Holder LL01LUCR60H2
Tape LL01A00XGXX

Fixing Method

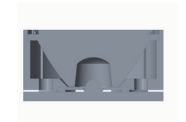
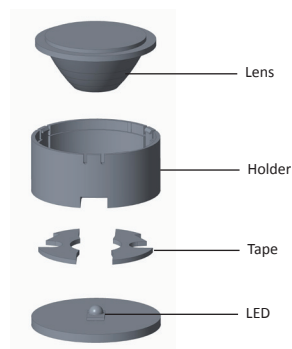

Mechanical Specification

*All dimensions are in millimeters.

Holder Dimension

LL01OSMZ25H2

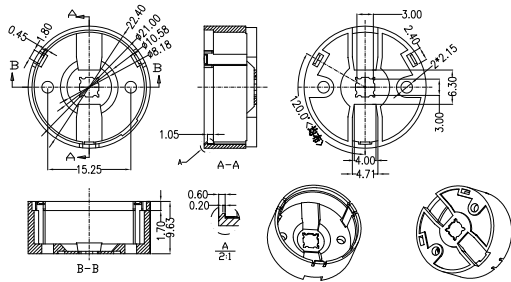

Assembly Instruction

Part No LL01OS-EX××L06-M2-T
 Holder LL01OSMZ25H2
 Tape LL01A00XGXX

Fixing Method

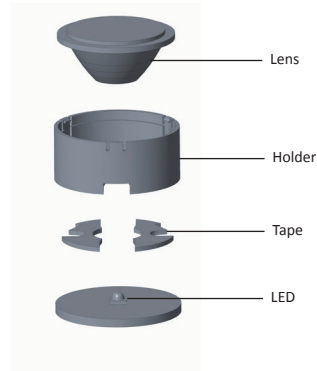

Holder Dimension

LL01ZZCL60H2

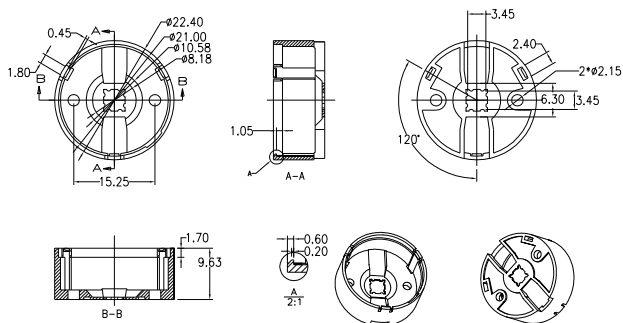

Assembly Instruction

Part No LL01ZZ-EX××L06-M2-T
 Holder LL01ZZCL60H2
 Tape LL01A00XGXX

Fixing Method

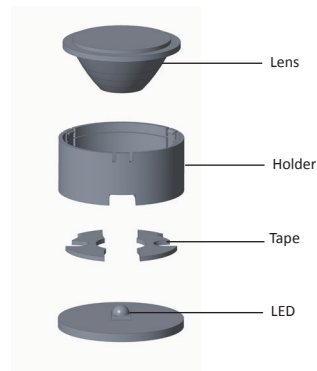

Holder Dimension

LL01ZZWB60H2

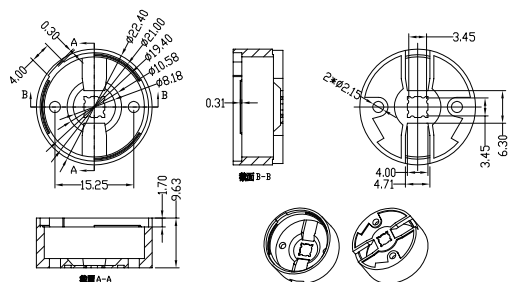

Assembly Instruction

Part No LL01ZZ-EX××L06-U2-T
 Holder LL01ZZWB60H2
 Tape LL01A00XGXX



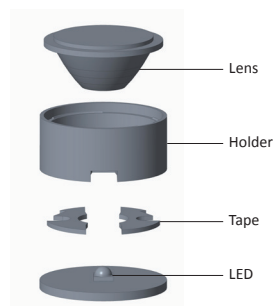



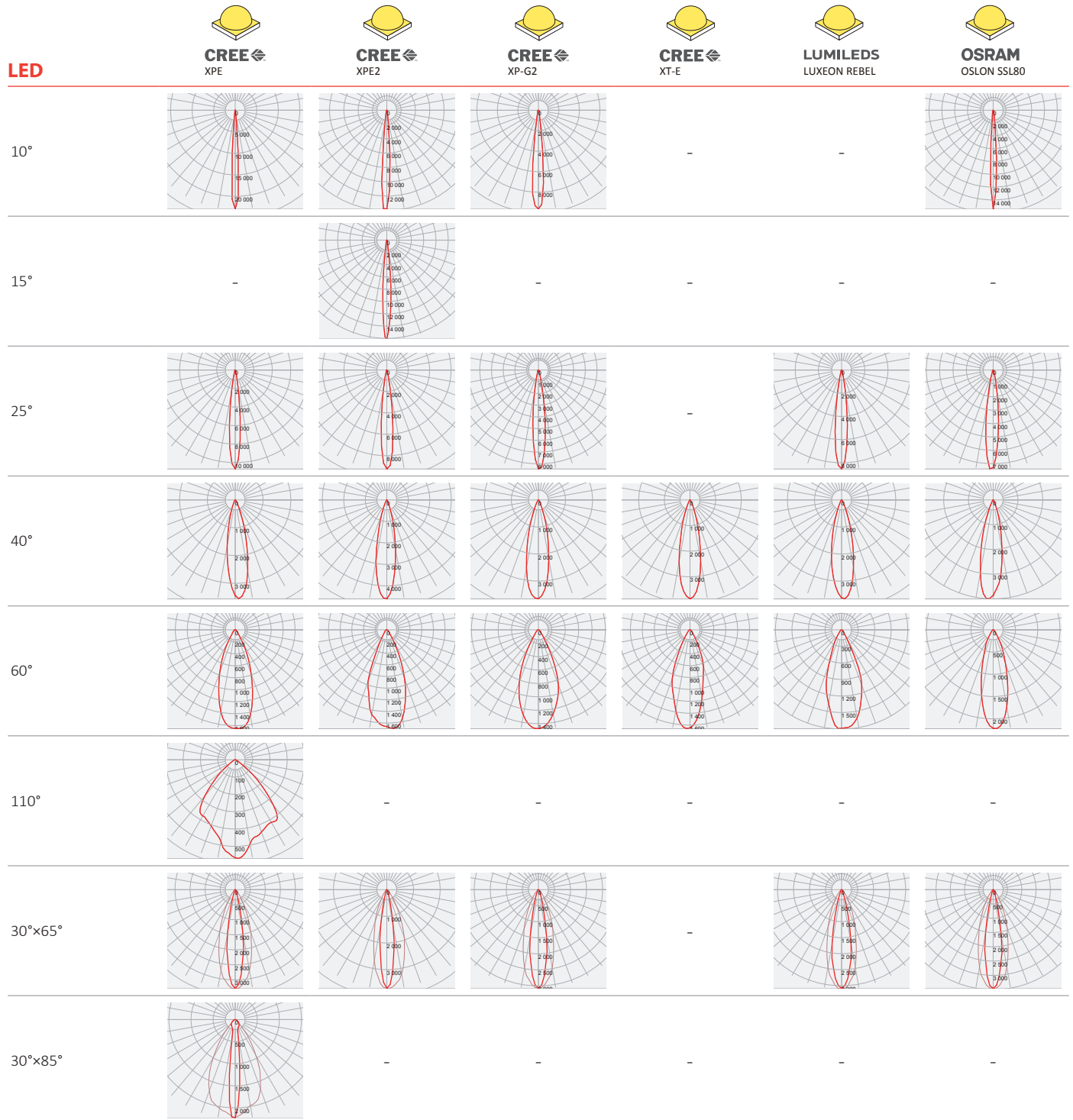



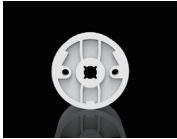







Fixing Method

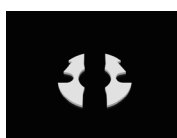





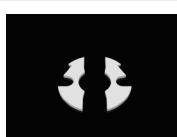

Photometric Distribution



Details by LED

Part No	Holder	Tape	LED Package Size	LED
LL01CR-EX×L06-M2-T	 LL01CRNW10H2	 LL01A00XGXX	3535	 CREE XPE
LL01LU-EX×L06-M2-T	 LL01LUCR60H2	 LL01A00XGXX	3045	 LUMILEDS LUXEON REBEL
LL01OS-EX×L06-M2-T	 LL01OSMZ25H2	 LL01A00XGXX	3030	 OSRAM OSOLON SSL80
LL01ZZ-EX×L06-M2-T	 LL01ZZCL60H2	 LL01A00XGXX	3535	    CREE CREE CREE CREE XPE XPE2 XP-G2 XT-E
LL01ZZ-EX×L06-U2-T	 LL01ZZWB60H2	 LL01A00XGXX	3535	 CREE XPE

LED	Part No	FWHM	cd / lm	IES
 CREE XPE	LL01CR-EX10L06-M2-T	8°	21.8	↓
	LL01CR-EX15L06-M2-T	-	-	-
	LL01CR-EX25L06-M2-T	12°	10.6	↓
	LL01CR-EX40L06-M2-T	23°	3.5	↓
	LL01CR-EX60L06-M2-T	38°	1.6	↓
	LL01CR-EX110L06-M2-T	81°	0.6	↓
	LL01CR-EX3065L06-M2-T	18°×37°	3.2	↓
	LL01CR-EX3085L06-M2-T	10°×55°	2.6	↓
	LL01ZZ-EX10L06-M2-T	7°	22.9	↓
	LL01ZZ-EX15L06-M2-T	-	-	-
	LL01ZZ-EX25L06-M2-T	12°	10.6	↓
	LL01ZZ-EX40L06-M2-T	23°	3.5	↓
	LL01ZZ-EX60L06-M2-T	38°	1.6	↓
	LL01ZZ-EX110L06-M2-T	81°	0.5	↓
	LL01ZZ-EX3065L06-M2-T	18°×37°	3.2	↓
	LL01ZZ-EX3085L06-M2-T	11°×56°	2.2	↓
	LL01ZZ-EX10L06-U2-T	7°	22.9	↓
	LL01ZZ-EX15L06-U2-T	-	-	-
	LL01ZZ-EX25L06-U2-T	12°	10.6	↓
	LL01ZZ-EX40L06-U2-T	23°	3.5	↓
LL01ZZ-EX60L06-U2-T	38°	1.6	↓	
LL01ZZ-EX110L06-U2-T	81°	0.5	↓	
LL01ZZ-EX3065L06-U2-T	18°×37°	3.2	↓	
LL01ZZ-EX3085L06-U2-T	11°×56°	2.2	↓	
 CREE XPE2	LL01ZZ-EX10L06-M2-T	8°	13.8	↓
	LL01ZZ-EX15L06-M2-T	9°	16.0	↓
	LL01ZZ-EX25L06-M2-T	13°	9.2	↓
	LL01ZZ-EX40L06-M2-T	22°	4.5	↓
	LL01ZZ-EX60L06-M2-T	41°	1.6	↓
	LL01ZZ-EX110L06-M2-T	-	-	-
	LL01ZZ-EX3065L06-M2-T	16°×35°	3.7	↓
	LL01ZZ-EX3085L06-M2-T	-	-	-
 CREE XP-G2	LL01ZZ-EX10L06-M2-T	11°	9.6	↓
	LL01ZZ-EX15L06-M2-T	-	-	-
	LL01ZZ-EX25L06-M2-T	14°	8.4	↓
	LL01ZZ-EX40L06-M2-T	25°	3.6	↓
	LL01ZZ-EX60L06-M2-T	44°	1.4	↓
	LL01ZZ-EX110L06-M2-T	-	-	-
	LL01ZZ-EX3065L06-M2-T	19°×34°	3.0	↓
LL01ZZ-EX3085L06-M2-T	-	-	-	
 CREE XT-E	LL01ZZ-EX10L06-M2-T	-	-	-
	LL01ZZ-EX15L06-M2-T	-	-	-
	LL01ZZ-EX25L06-M2-T	-	-	-
	LL01ZZ-EX40L06-M2-T	24°	3.8	↓
	LL01ZZ-EX60L06-M2-T	36°	1.6	↓
	LL01ZZ-EX110L06-M2-T	-	-	-
LL01ZZ-EX3065L06-M2-T	-	-	-	
LL01ZZ-EX3085L06-M2-T	-	-	-	

LED	Part No	FWHM	cd / lm	IES	
 LUMILEDS LUXEON REBEL	LL01LU-EX10L06-M2-T	-	-	-	
	LL01LU-EX15L06-M2-T	-	-	-	
	LL01LU-EX25L06-M2-T	13°	8.5	↓	
	LL01LU-EX40L06-M2-T	25°	3.6	↓	
	LL01LU-EX60L06-M2-T	39°	1.7	↓	
	LL01LU-EX110L06-M2-T	-	-	-	
	LL01LU-EX3065L06-M2-T	21°×33°	3.0	↓	
	LL01LU-EX3085L06-M2-T	-	-	-	
	 OSRAM OSOLON SSL80	LL01OS-EX10L06-M2-T	7°	15.4	↓
		LL01OS-EX15L06-M2-T	-	-	-
LL01OS-EX25L06-M2-T		14°	7.3	↓	
LL01OS-EX40L06-M2-T		24°	3.9	↓	
LL01OS-EX60L06-M2-T		30°	2.2	↓	
LL01OS-EX110L06-M2-T		-	-	-	
LL01OS-EX3065L06-M2-T		19°×34°	3.4	↓	
LL01OS-EX3085L06-M2-T		-	-	-	

Product Nomenclature

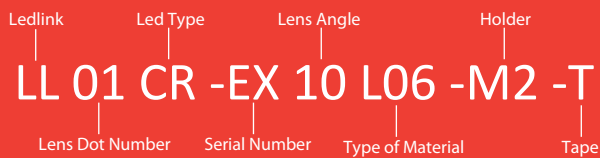

Ledlink Optics, Inc

Taiwan HQ

15F, No.655, Bannan Rd., Chung-Ho Dist.,
New Taipei City, Taiwan 235

Ledlink Optics (Dongguan) Co., Ltd

Dongguan Factory

No.5, TianKeng Industrial Dist., HengLiTown, DongGuan City,
GuangDong Province, China 523478

Ledlink Optics (Yangzhou) Co., Ltd

Yangzhou Factory

No.180, LinJiang Rd., YangZhou City, Jiangsu Province, China 225009

www.ledlink-optics.com

service@ledlink-optics.com



Mouser Electronics

Authorized Distributor

Click to View Pricing, Inventory, Delivery & Lifecycle Information:

[LedLink Optics:](#)

[LL01ZZ-EX40L06](#)