

L4009 Rev. A 01/13

Index:

English	1-15
Français	17-31
Deutsch	33-47
Italiano	49-63
Español	65-79
Nederlands	81-95
Portuguese	97-111
Norwegian	113-127
Svensk	129-143



1.0 IMPORTANT RECEIVING INSTRUCTIONS

Visually inspect all components for shipping damage. Shipping damage is **not** covered by warranty. If shipping damage is found, notify carrier at once. The carrier is responsible for all repair and replacement costs resulting from damage in shipment.

SAFETY FIRST

2.0 SAFETY ISSUES



Read all instructions, warnings and cautions carefully.

Follow all safety precautions to avoid personal injury or property damage during system operation. Enerpac cannot be responsible for damage or injury resulting from unsafe product use, lack of maintenance or incorrect product and/or system operation. Contact Enerpac when in doubt as to the safety precautions and operations. If you have never been trained on high-pressure hydraulic safety, consult your distribution or service center for a free Enerpac Hydraulic safety course.

Failure to comply with the following cautions and warnings could cause equipment damage and personal injury.

A **CAUTION** is used to indicate correct operating or maintenance procedures and practices to

prevent damage to, or destruction of equipment or other property.

A **WARNING** indicates a potential danger that requires correct procedures or practices to avoid personal injury.

A **DANGER** is only used when your action or lack of action may cause serious injury or even death.



WARNING: Wear proper personal protective gear when operating hydraulic equipment.



WARNING: Stay clear of loads supported by hydraulics. A cylinder, when used as a load lifting device, should never be used as a load holding device. After the load has been raised or lowered, it must always be blocked mechanically.



WARNING: USE ONLY RIGID PIECES TO HOLD LOADS.

Carefully select steel or wood blocks that are capable of supporting the load. Never use a hydraulic cylinder as a shim or spacer in any lifting or pressing application.



DANGER: To avoid personal injury keep hands and feet away from cylinder and workpiece during operation.



WARNING: Do not exceed equipment ratings. Never attempt to lift a load weighing more than the capacity of the cylinder. Overloading causes equipment failure and possible personal injury. The cylinders are designed for a max. pressure of 10,000 psi [700 bar]. Do not connect a jack or cylinder to a pump with a higher pressure rating.



Never set the relief valve to a higher pressure than the maximum rated pressure of the pump. Higher settings may result in equipment damage and/or personal injury.



WARNING: The system operating pressure must not exceed the pressure rating of the lowest rated component in the system. Install pressure gauges in the system to monitor operating pressure. It is your window to what is happening in the system.



CAUTION: Avoid damaging hydraulic hose. Avoid sharp bends and kinks when routing hydraulic hoses. Using a bent or kinked hose will cause severe back-pressure. Sharp bends and kinks will internally damage the hose leading to premature hose failure.



Do not drop heavy objects on hose. A sharp impact may cause internal damage to hose wire strands. Applying pressure to a damaged hose may cause it to rupture.



IMPORTANT: Do not lift hydraulic equipment by the hoses or swivel couplers. Use the carrying handle or other means of safe transport.



CAUTION: Keep hydraulic equipment away from flames and heat. Excessive heat will soften packings and seals, resulting in fluid leaks. Heat also weakens hose materials and packings. For optimum performance do not expose equipment to temperatures of 150 °F [65 °C] or higher. Protect hoses and cylinders from weld spatter.



DANGER: Do not handle pressurized hoses. Escaping oil under pressure can penetrate the skin, causing serious injury. If oil is injected under the skin, see a doctor immediately.



WARNING: Only use hydraulic cylinders in a coupled system. Never use a cylinder with unconnected couplers. If the cylinder becomes extremely overloaded, components can fail catastrophically causing severe personal injury.



WARNING: BE SURE SETUP IS STABLE BEFORE LIFTING LOAD.

Cylinders should be placed on a flat surface that can support the load. Where applicable, use a cylinder base for added stability. Do not weld or otherwise modify the cylinder to attach a base or other support.



Avoid situations where loads are not directly centered on the cylinder plunger. Off-center loads produce considerable strain on cylinders and plungers. In addition, the load may slip or fall, causing potentially dangerous results.



Distribute the load evenly across the entire saddle surface. Always use a saddle to protect the plunger.



IMPORTANT: Hydraulic equipment must only be serviced by a qualified hydraulic technician. For repair service, contact the Authorized ENERPAC Service Center in your area. To protect your warranty, use only ENERPAC oil.



WARNING: Immediately replace worn or damaged parts with genuine ENERPAC parts. Standard grade parts will break causing personal injury and property damage. ENERPAC parts are designed to fit properly and withstand high loads.

3.0 DESCRIPTION

The Enerpac DGR-2 digital pressure gauge is designed to monitor system pressures of up to 20,000 psi [1380 bar]. Standard features include:

- Displays available in multiple units: psi, bar, mPa and kg/cm² (user-selectable).
- Zero reset feature ensures that gauge reads actual system pressure.
- Powered by two 1.5V AA batteries (included).
- IP67 rated case design.
- User-selectable gauge shut-off timer.
- CE and RoHS compliant.

Note: Refer to Section 7.0 of this manual for detailed product specifications and installation dimensions.

4.0 INSTALLATION INFORMATION

IMPORTANT: To ensure proper operation and to help prevent gauge failure, read and understand the following instructions and precautions before installing the gauge.



WARNING: A failure resulting in personal injury and/or property damage may be caused by excessive overpressure, excessive vibration or pressure pulsation, excessive instrument temperature, corrosion of the pressure containing parts, or other misuse. Consult Enerpac before installing the gauge if there are any questions or concerns.

Overpressure:

Pressure spikes in excess of the rated pressure of the gauge may cause irreversible electrical and/or mechanical damage to the pressure measuring and containing elements. Fluid hammer and surges can destroy any pressure transducer and must always be avoided. A pressure snubber should be installed to eliminate the damaging hammer effects. Fluid hammer occurs when a liquid flow is suddenly stopped, as with quick closing solenoid valves. Surges occur when flow is suddenly begun, as when a pump is turned on at full power or a valve is quickly opened.



WARNING: Gauge is rated at 20,000 psi [1380 bar] maximum pressure. Never exceed this maximum pressure rating.

Pressure Surges:

Surges are particularly damaging to pressure gauges if the pipe is originally empty. To avoid pressure surges, fluid lines should remain full (if possible), pumps should be brought up to power slowly, and valves opened slowly. To avoid damage from both fluid hammer and surges, a surge chamber should be installed. Symptoms of fluid hammer and surge's damaging effects:

- Digital gauge exhibits large zero offset.
- Digital gauge pressure display remains constant regardless of pressure.
- Error code is displayed on screen.

Cold Temperatures:

Formation of ice in the gauge pressure port can cause permanent damage to the gauge. Whenever possible, mount the gauge in the upright vertical position to help prevent possible overpressure damage due to freezing.

Note: Inspect the entire hydraulic system for leaks if it is suspected that water has entered the system. Make required repairs before returning system to operation.

Installation Requirements:







A 1-1/16 inch [27mm] hex wrench is required for tightening the gauge to the hydraulic connection. Apply Teflon tape or a suitable sealing compound to the 1/4 inch NPTF threads of the gauge. Using the wrench, tighten 1 turn beyond hand-tight or until a leak-proof seal has been achieved.



CAUTION: Tightening the gauge by grasping or putting a tool on the plastic housing can cause permanent damage to the gauge.

5.0 OPERATING INSTRUCTIONS

Keypad:

- ① Power On-Off / Enter 
- ② Zero / Up Arrow / Tare  ▲ Tare
- ③ Menu Selection / Down / Backlight Arrow  ▲ 
- ④ Key presses are **short** – less than 0.5 seconds, or **long** – greater than 0.5 seconds
 



LCD Display and functions:

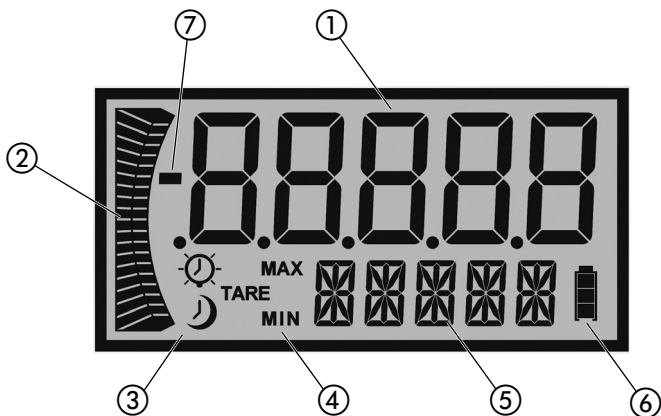

- ① 5 numerical digits for pressure display.
- ② 20 segment pressure range bar graph – each segment equals 5% of range.
- ③ Sleep and Backlight Timer symbols.
- ④ Maximum / Minimum Pressure and Tare icons.
- ⑤ 5 character alpha-numeric digit display.
- ⑥ 4 segment battery life indicator.
- ⑦ Negative pressure indicator.





Note: Key presses designated as short (less than 0.5 sec) are indicated by “” ICON

Key presses designated as long (greater than 0.5 sec.) are indicated by “” ICON

Turn the Gauge ON/OFF

Press   key to turn gauge ON / OFF. When initially turned ON, the display will momentarily show all LCD segments lit, product version and full scale range; the unit will then proceed automatically to the Measurement mode.

Zero Function:

Press  . Upon release, the numeric display momentarily disappears and “ZERO” shows in alpha display, then returns to Measurement mode. The pressure should now read 0. Zero value is stored in memory.



Note 1: A display message of “RLOCK” indicates that zero is more than $\pm 5\%$ from factory calibration. Zeroing is not possible.

Note 2: A message of “ZLOCK” indicates that zero lock function is activated.



Tare Function:





Subtracts current pressure value from value displayed in Measurement mode.

In Measurement mode, apply desired pressure and press **ZERO**  to enable the tare function. The display will quickly flash “TARE”, then the “TARE” icon will be displayed and the pressure reading will blink. The unit should now read 0. Press **ZERO**  again to disable the tare function. The display will quickly flash “T OFF”, then the “TARE” icon will disappear and the pressure reading will no longer be blinking. The unit will now return to Measurement mode.







Programming:

To enter Menu mode

1. Press **menu**  and release to proceed to Programming mode.
2. Press **▲**, **▼**  to scroll through programmable menu options.
3. When desired option is reached press **ENTER**  to access that parameter.
4. If at any time you choose to EXIT the Menu mode (or sub-menu mode) hold **menu** . Your work will not be saved.

Programmable Parameters:

Units of Measure:





1. In Menu mode, press **▲**, **▼**  to scroll to “UNITS”, press **ENTER** .
2. Choose engineering units by scrolling **▲**, **▼**  until desired unit is displayed, “PSI, BAR, kg/cm, mPa, customer defined units (CUSTM)”.
3. Press **ENTER**  to select units and return to Measurement mode.

Note: Custom units programming, see page 8.







Custom Units of Measure:

Allows a user to define a custom unit of measure, user must enter the full scale value of the desired reading, which can be done as follows.



1. In Menu mode press ,  , select "CUSTM", press  .
2. Select decimal point location:





The alphanumeric display shall show "SELDP"





The first screen to appear will show all digits lit up as "5" and the rightmost decimal point will blink (5 5 5 5.5) unless the custom units feature had been used previously. If it had been used, the digits and decimal point position shall correspond to the last values set. Use the ,   keys to move the decimal point to the left or the right. Once the decimal point is in the desired position, press   to lock it in place. When the key is released the display reads "DIGIT".

3. Choose full scale value:

The alpha numeric display shall show "DIGIT".

The next screen will continue to show all digits as "5", with the leftmost digit blinking and the decimal point fixed in the previously chosen position. However, if the custom units feature has been used previously, then the digits shall correspond to the last value. The decimal point remains at the location chosen in step 1. Press ,   to change the value of the digit between 0-9.

Once the desired value is displayed, press the   key to lock it in place. Now the next digit to the right will begin blinking. Repeat this procedure for all 5 digits. When   is pressed and released with the fifth digit flashing, the gauge will briefly display "DONE" then return to Measurement mode and display "CUSTM" along with the numeric readings to signify that the feature is use.







The user can optionally exit at any point before the enter key is pressed with  . If the user exits the menu by a   before completing step 2 or there is a menu timeout, then whatever the user entered will be lost.

Note: The bar graph uses the factory default setting when custom units are used.

Note: The magnitude of the value entered when using the custom units feature can significantly increase the noise on the display, which can affect the zero and tare functions as well as the stability of the pressure reading displayed. If required, consult factory for recommended limitations on full scale input.

Maximum / Minimum:

Displays maximum / minimum pressure values; this is initiated upon powering the unit or since the values were cleared.







1. When in Menu mode press ,  to scroll to 'Max' (maximum display); this is indicated in small font to the left of the display's unit of measure.
2. To clear *both* Min and Max values, press and hold  to return to Measurement mode.
3. Release of this key will leave you in Menu mode. Use ,  to continue scrolling through the menu options, OR hold,  to return to Measurement mode.

Note: Clearing Minimum / Maximum values will result in a blank display except for the associated Min. / Max. icon and battery indicator.

Note: The following actions will also clear min/max values. Power off, zero gauge function, tare function, field calibration function, units programming, update rate, or reset.

Timer:

Controls how long the gauge will remain powered ON once the Power key  is pressed.





1. When in Menu mode press ,  to scroll until "TIMER" is displayed.
2. Press  to select.
3. Then, press ,  to scroll through values. "NONE" designates that the gauge will remain ON until the power key  is pressed a second time. Any other value (1 min [default] / 5 min / 20 min), other than "NONE", will designate the duration of time this function will be in effect.
4. Press  to select desired value; timer icon will be shown on the display and the unit will display "DONE" then return to Measurement mode.

Feature: Timer icon will flash 10 seconds prior to gauge shut down. While the gauge is powered on, any key press will reset the timer.



Light:

Determines how long the backlight will remain ON after any key is pressed in Measurement or Menu modes (Note: The timer is reset with any key being pressed.)







1. While in Menu mode, press ,  \rightarrow until "LIGHT" is displayed.
2. Press  \rightarrow for timer value to appear; "ON" refers to the backlight remaining ON at all times unit is powered ON, "PRESS" designates that the backlight is switched on / off by briefly pressing the backlight  \rightarrow whereas, "OFF" indicates the backlight will never be illuminated. Selecting time values, "1 MIN" (default), "5 MIN", "20 MIN", will activate the backlight symbol on the LCD display for the designated minutes.
3. Press  \rightarrow to select backlight time (display will briefly show "DONE") and return to Measurement mode.

Note: In "PRESS" mode; factory has set 1 hour timer to save battery.

Feature: Backlight indicator will blink 10 seconds prior to light shut off.

Update:

Utilized to select the rate at which the displayed pressure value is updated on the screen. This function is used when rapid changes in pressure cause "flutter" in the display values; longer intervals will reduce the update rate and "average" the readings on such applications.







1. In Menu mode, press ,  \rightarrow until "UPDAT" appears.
2. Press  \rightarrow to select.
3. Press ,  \rightarrow to select values for "1 SEC" (default), "500 MSEC", or "250 MSEC".
4. Press  \rightarrow to select value (display will briefly show "DONE") and return to Measurement mode.

Note: Changing value to anything other than 1 sec may cause a slight zero offset, and it is recommended that the gauge be fully vented and re-zeroed before taking accurate readings. Also, battery life will be reduced by use of an update rate faster than 1 SEC.



Z-Lock:

Utilized to prevent inadvertent re-zeroing of the gauge.











1. In Menu mode, press ,  \rightarrow until "ZLOCK" appears.
2. Press  \rightarrow to select.
3. Press ,  \rightarrow to select "L ON" or "L OFF" (default).
4. Press  \rightarrow to select value (display will briefly show "DONE") and return to Measurement mode.

Note: If Z-Lock is activated, the gauge will display "ZLOCK" if zero is attempted.



Re-Calibration:

Provides the user the ability to field calibrate the product. Original factory calibration is permanently retained in memory and can be recalled at any time.

1. In Menu mode press ,  \rightarrow until "RECAL" appears; proceed to press  \rightarrow .
2. Display will indicate "FACT" (factory) "FIELD" or "NEW". Press ,  \rightarrow to scroll.
3. Pressing  \rightarrow while "FACT" (factory) is displayed will restore values of factory calibration.
4. Pressing  \rightarrow when "FIELD" is displayed will restore values from latest field calibration.
5. Pressing "Enter" key  \rightarrow when "NEW" appears will enter the Recalibrate mode.
6. When "NEW" is displayed, press  \rightarrow ; upon release, the display will flash "OK/ APPLY/ REF/ PSI/ THEN/ PRESS/ ENTER/ TO/ START/ OR/ OTHER/ TO/ ABORT". Numeric display will read .00000. Vent sensor to atmospheric pressure, press  \rightarrow display will show "WAIT" and count down from 6 seconds then briefly display CAL then automatically go to next step.
7. Display flashes "APPLY/ REF/ PSI/ THEN/ PRESS/ ENTER/ TO/ START/ OR/ OTHER/ TO/ ABORT"; apply the full scale pressure in units of psi indicated in numeric display to gauge. Press  \rightarrow display will show "WAIT" and count down from 6 seconds then briefly display CAL then automatically go to next step.









8. Display flashes “APPLY/ REF/ PSI/ THEN/ PRESS/ ENTER/ TO/ START/ OR/ OTHER/ TO/ ABORT”; apply the pressure indicated in numeric display to gauge and press  → display will show “WAIT” and count down from 6 seconds then briefly display GOOD then exit into Measurement mode.

Note: Recalibration is allowed only if test parameters are within $\pm 7\%$. If outside this window, the display will indicate “CAL FAIL / INPUT PRES TOO LOW (HIGH) / PRESS ENTER TO RETRY / PRESS OTHER TO ABORT”.







Note: “FIELD” option appears only if gauge has been successfully field recalibrated.







Graph:

Provides the user the ability to modify pressure values dictating the minimum / maximum indications over the 20 segment bar graph.

1. In Menu mode press ,  → , until “GRAPH” appears; press  → .
2. Display will indicate “CGOFF” (custom graph off) [default], “CG ON” (custom graph on), or “NEWCG” (new custom graph). Press ,  → to scroll.
3. To recall the last custom graph entered when “CG ON” is displayed press  → . Display will briefly show “DONE” and return to Measurement mode.
4. To reset bar graph to full scale range; when “CGOFF” is displayed press  → . Display will briefly show “DONE”, and return to Measurement mode.
5. To enter a new custom bar graph; when “NEWCG” is displayed press  → .



6. To program minimum graph percentage, the display will indicate 0 0 with the right digit flashing, the bottom most segment of the bar graph will flash, and the display will read "PCTFS" (percent full scale). Press ,  to scroll to a number 0-9. Press  to select that number. The left digit will now begin to flash. Press ,  to scroll to a number 0-9. Press  to select that number. The 2 digit number entered represents the percentage of full scale to be used as the low end of the graph (0-99%).

7. To program maximum percentage of full scale the display will indicate 1 0 0 with the right digit flashing, the upper most segment of the graph will flash, and the display will read PCTFS (percent full scale). Press ,  to scroll to a number 0-9. Press  to select that number. The left 2 digits will now begin to flash. Press ,  to scroll to a number 0-10. Press  to select that number. The number entered represents the percentage of full scale to be used as the high end of the graph. Note: 100 is the highest and only possible 3 digit number. If the low number is equal to or larger than the high number, the unit will flash "REJECT" and it will exit back into the "GRAPH" sub-menu.

Note: A display message "UNLOCK" indicates that custom units are being used and bar graph minimum and maximum are set to the factory defaults.

Reset:

Returns the product to the factory default values. Preserves field calibration. Factory calibration can be restored in the "RECAL" menu.

In Menu mode press ,  until "RESET" appears on display's lower line. Press .

Factory defaults pertain to units, timer, backlight, update rate, zero lock.

Display will indicate "DONE" then gauge will switch to "OFF" condition.



6.0 BATTERY REPLACEMENT

The gauge is powered by two 1.5 volt type AA alkaline batteries. In normal service, the batteries will last approximately 2000 hours before requiring replacement. Actual battery life will vary depending on gauge usage, ambient temperature and other factors.

Replace the batteries as described in the following procedure:

1. Slide the protective boot (not shown) off of the gauge housing.
2. Grip knurled back cover and rotate counter-clockwise until the 'unlock' icon is in alignment with the arrow – this is on the housing at the base of the pressure connection (see view A).
3. Remove cover by pulling straight back and replace AA alkaline batteries accordingly; ensure that the batteries are in the proper polarity position (see view B).
4. For reattachment of cover, align the 'unlock' icon with the arrow, push cover straight in then turn clockwise until the arrow is in alignment with the 'Lock' icon (see view C).
5. Reinstall the protective boot (not shown) on the gauge housing.

Note: Reinstallation of the back cover may cause the gauge to read negative pressure. This is a temporary issue as the internal case pressure will be relieved by the case vent and equalize with atmospheric pressure (90% of the offset will equalize within 1 minute, the remaining 10% may take up to 5 minutes).

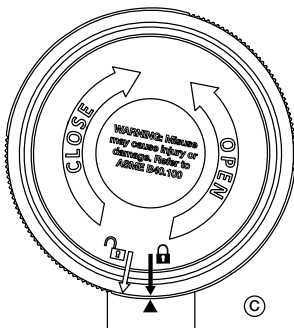
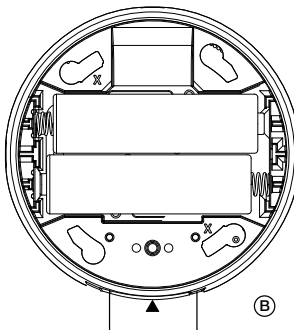
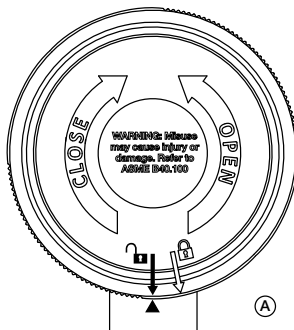

7.0 TECHNICAL DATA - MODEL DGR-2 DIGITAL PRESSURE GAUGE

Dimensions:

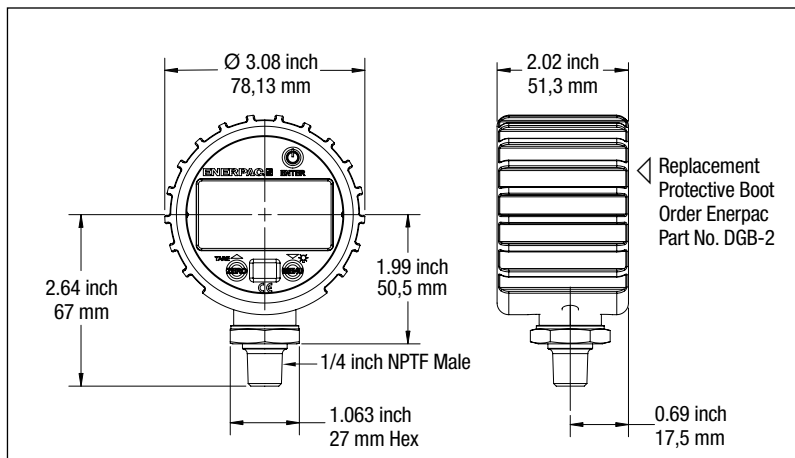

Specifications:

Maximum Pressure Rating				Accuracy	Update Rate	Power Req'd	Weight		Hydraulic Connection	Enclosure Rating
psi	bar	mPa	kg/cm ²	0.25%	250ms 500ms 1s (user-selectable)	3 VDC (two AA alkaline batteries)	lbs	kg	1/4 inch NPTF Male	IP67
20000	1380	140	1400				0.5	0,23		
WARNING: Never exceed maximum pressure rating.										

Environmental Specifications	
	Acceptable Range
Ambient Operating Temperature	4°F to 140°F [-20°C to 60°C]
Hydraulic Oil Temperature	4°F to 176°F [-20°C to 80°C]
Storage Temperature (batteries installed)	4°F to 140°F [-20°C to 60°C]
Storage Temperature (batteries removed)	4°F to 176°F [-20°C to 80°C]
Temperature Coefficient	0.04%/°F [-20°C to 180°C] zero and span, reference temp. 70°F

Range & Interval Information		
Unit of Measure Selected	Range	Interval
psi	0-20000	1
bar	0-1380	0.1
mPa	0-140	0.01
kg/cm ²	0-1400	0.1

Agency Approvals
CE EN 61326 (1998) CE EN 61326 Annex A (heavy industrial) UL/cUL-61010-1 (pending) RoHS compliant

This device conforms with the requirements for CE Marking.

L4009 Rev. A 01/13

**1.0 INSTRUCTIONS IMPORTANTES
RELATIVES À LA RÉCEPTION**

Inspecter tous les composants pour vous assurer qu'ils n'ont subi aucun dommage en cours d'expédition. Les dommages subis en cours de transports ne sont pas couverts par la garantie. S'ils sont abîmés, aviser immédiatement le transporteur, qui est responsable des frais de réparation et de remplacement résultant de dommages en cours de transport.

LA SÉCURITÉ AVANT TOUT !**2.0 SÉCURITÉ**

Lire attentivement toutes les instructions et mises en garde et tous les avertissements. Suivre toutes les précautions pour éviter d'encourir des blessures personnelles ou de provoquer des dégâts matériels durant le fonctionnement du système. Enerpac ne peut pas être tenue responsable de dommages ou blessures résultant de l'utilisation risquée du produit, d'un mauvais entretien ou d'une application incorrecte du produit et du système. En cas de doute sur les précautions ou les applications, contacter Enerpac.

Respecter les mises en garde et avertissements suivants sous peine de provoquer des dégâts matériels et des blessures corporelles.

Une mise en garde **ATTENTION** sert à indiquer des procédures d'utilisation et de maintenance correctes qui visent à empêcher l'endommagement voire la destruction du matériel ou d'autres dégâts.

Un **AVERTISSEMENT** indique un danger potentiel qui exige la prise de mesures particulières visant à écarter tout risque de blessure.

La mention **DANGER** n'est utilisée que lorsqu'une action ou un acte de négligence risque de causer des blessures graves, voire mortelles.



AVERTISSEMENT : Porter un équipement de protection personnelle adéquat pour utiliser un appareil hydraulique.



AVERTISSEMENT : **Rester à l'écart de charges soutenues par un mécanisme hydraulique.** Un vérin, lorsqu'il est utilisé comme monte-charge, ne doit jamais servir de support de charge. Après avoir monté ou abaissé la charge, elle doit être bloquée par un moyen mécanique.



AVERTISSEMENT : **UTILISER SEULEMENT DES PIÈCES RIGIDES POUR SOUTENIR LES CHARGES.** Sélectionner avec précaution des blocs d'acier ou de bois capables de supporter la charge. Ne jamais utiliser un vérin hydraulique comme cale ou intercalaire d'appui pour les applications de levage ou de pressage.



DANGER : Pour écarter tout risque de blessure personnelle, maintenir les mains et les pieds à l'écart du vérin et de la pièce à usiner durant l'utilisation.



AVERTISSEMENT : Ne pas dépasser les valeurs nominales du matériel. Ne jamais essayer de soulever une charge d'un poids supérieur à la capacité du vérin. Une surcharge entraînera la panne du matériel et risque de provoquer des blessures corporelles. Les vérins sont conçus pour une pression maximale de 700 bar. Ne pas connecter de cric ou de vérin à une pompe affichant une pression nominale supérieure.



Ne jamais régler la soupape de retour (uniquement les pompes équipées de soupape de retour réglable par l'utilisateur) à une pression plus élevée que la pression nominale maximum de la pompe. Un réglage plus élevé peut entraîner des dommages à l'équipement ou des blessures corporelles.



WARNING : La pression de fonctionnement du système ne doit pas dépasser la pression nominale du composant du système affichant la plus petite valeur. Installer des manomètres dans le système pour surveiller la pression de fonctionnement. Ils permettent de vérifier ce qui se passe dans le système.



ATTENTION : Éviter d'endommager les tuyaux hydrauliques. Éviter de les plier et de les tordre en les mettant en place. Un tuyau plié ou tordu entraînera un fort retour de pression. Les plis et coudes prononcés endommageront par ailleurs l'intérieur du tuyau, provoquant son usure précoce.



Ne pas faire tomber d'objets lourds sur le tuyau. Un fort impact risque de causer des dégâts intérieurs (torons métalliques). L'application d'une pression sur un tuyau endommagé risque d'entraîner sa rupture.



IMPORTANT: Ne pas soulever le matériel hydraulique en saisissant ses tuyaux ou ses raccords articulés. Utiliser la poignée de transport ou procéder d'une autre manière sûre.



ATTENTION : Garder le matériel hydraulique à l'écart de flammes et d'une source de chaleur. Une forte température amollira les garnitures et les joints et provoquera par conséquent des fuites. La chaleur affaiblit également les matériaux et les garnitures du tuyau. Pour une performance maximale, ne pas exposer le matériel à une température supérieure ou égale à 65 °C [150 °F]. Protéger tuyaux et vérins de projections de soudure.



DANGER : Ne pas manipuler les tuyaux sous pression. L'huile sous pression qui risque de s'en échapper peut pénétrer dans la peau et

provoquer des blessures graves. En cas d'injection d'huile sous la peau, contacter immédiatement un médecin.



AVERTISSEMENT : Utiliser des vérins hydrauliques uniquement dans un système couplé. Ne jamais utiliser un vérin en présence de raccords déconnectés. La surcharge du vérin peut avoir des effets désastreux sur ses composants, qui peuvent causer des blessures graves.



AVERTISSEMENT : S'assurer de la stabilité de l'ensemble avant de lever une charge. Le vérin doit être placé sur une surface plane capable de supporter la charge. Lorsqu'applicable, utiliser une base de vérin pour accroître la stabilité. Ne pas souder ou modifier le vérin de quelque façon que ce soit pour y fixer une base ou un autre dispositif de support.



Éviter les situations où les charges ne sont pas directement centrées sur le piston du vérin. Les charges décentrées imposent un effort considérable au vérins et pistons. En outre, la charge risque de glisser ou de tomber, ce qui crée un potentiel de danger.



Répartir la charge uniformément sur toute la surface d'appui. Toujours utiliser un coussinet d'appui si des accessoires non filetés sont utilisés.



IMPORTANT : Le matériel hydraulique doit uniquement être réparé par un technicien hydraulique qualifié. Pour toute réparation, contacter le centre de réparation ENERPAC agréé le plus proche. Pour assurer la validité de la garantie, n'utiliser que de l'huile ENERPAC.



AVERTISSEMENT : Remplacer immédiatement les pièces usées ou endommagées par des pièces ENERPAC authentiques. Les pièces de qualité standard se casseront et provoqueront des blessures et des dégâts matériels. Les pièces ENERPAC sont conçues pour s'ajuster parfaitement et résister à de fortes charges.

3.0 DESCRIPTION

Le manomètre numérique DGR-2 Enerpac est conçu pour surveiller les pressions d'un système jusqu'à 1380 bar [20 000 psi]. Les fonctions standard comprennent :

- Affichages disponibles en plusieurs unités: psi, bar, mPa et kg/cm² (sélectionnable par l'utilisateur).
- La fonction de réinitialisation du zéro garantit que le manomètre lise la pression réelle du système.
- Alimenté par deux piles AA 1.5V (incluses).
- Conception du boîtier selon IP67.
- Temporisation d'arrêt du manomètre sélectionnable par l'utilisateur
- Conformité CE et RoHS.

Remarque : Reportez-vous à la section 7.0 de ce manuel pour connaître les spécifications détaillées du produit et les dimensions d'installation.

4.0 INFORMATIONS D'INSTALLATION

IMPORTANT : Veuillez lire et comprendre les instructions et précautions suivantes avant d'installer le manomètre afin d'en assurer le bon fonctionnement et d'aider à en prévenir toute défaillance.



AVERTISSEMENT : Une défaillance entraînant des blessures et / ou des dommages matériels peut être provoquée par une surpression excessive, des vibrations ou des pulsations de pression excessives, une température de l'instrument excessive, de la corrosion des parties contenant la pression, ou tout autre usage incorrect. Consultez Enerpac avant d'installer le manomètre en cas de questions ou de préoccupations.

Surpression :

Des pointes de pression supérieures à la pression nominale du manomètre peuvent causer des dommages électriques et / ou mécaniques irréversibles aux éléments de mesure et contenant de la pression. Les coups de bélier et les surpressions peuvent détruire n'importe quel capteur de pression et doivent toujours être évités. Un amortisseur de pression doit être installé pour éliminer les effets néfastes des coups de bélier. Des coups

de bélier se produisent lorsque le débit du fluide est stoppé soudainement, comme avec des électrovannes rapides de fermeture. Les surpressions se produisent lorsque le débit est devient soudainement excessif, comme lorsqu'une pompe est mise en marche à pleine puissance ou qu'une vanne est ouverte rapidement.



AVERTISSEMENT : Le manomètre est calibré pour une pression maximale de 1380 bar [20 000 psi]. Ne dépassez jamais cette pression maximale.

Surpressions :

Les surpressions endommagent plus particulièrement les manomètres si les tuyaux sont initialement vides. Pour éviter les surpressions, les tuyauteries doivent (dans la mesure du possible) rester pleines, les pompes mises en marche lentement et les vannes ouvertes lentement. Pour éviter les dommages dus aux coupes de bélier et aux surpressions, une chambre d'équilibre doit être installée. Effets néfastes des coups de bélier et des surpressions :

- Le manomètre présente un décalage du zéro important.
- Le manomètre affiche toujours la même pression indépendamment de celle-ci.
- Un code d'erreur est affiché sur l'écran.

Températures froides :

La formation de glace à l'orifice du manomètre peut l'endommager de manière permanente. Dans la mesure du possible, monter le manomètre en position verticale afin d'éviter les risques de surpression possibles à cause du gel.

Remarque : Si vous soupçonnez que de l'eau a pénétré le système, vérifiez les fuites sur l'ensemble du système hydraulique. Effectuez les réparations nécessaires avant de remettre le système en exploitation.

Exigences pour l'installation :







Une clé hexagonale de 27 mm [1-1/16 po] est nécessaire pour serrer le manomètre sur le raccord hydraulique. Appliquez de la bande téflon ou un composant de jointage approprié sur le filetage femelle (NPTF) de 1/4 de pouce du manomètre. À l'aide de la clé, serrez un tour de plus qu'à la main ou bien jusqu'à ce qu'un jointage étanche soit atteint.



ATTENTION : Serrer le manomètre en saisissant ou en mettant un outil sur le boîtier en plastique peut causer des dommages permanents au manomètre.

5.0 MODE D'EMPLOI

Clavier :

- ① Marche-Arrêt / Entrée 
- ② Zéro / Flèche haut / Tarage
 ▲ Tarage
- ③ Choix Menu / Flèche bas / Rétroéclairage
 ▲ 
- ④ Appuis **courts**  moins de 0,5 seconde,
ou **longs**  – plus de 0,5 seconde



Affichage LCD et fonctions :

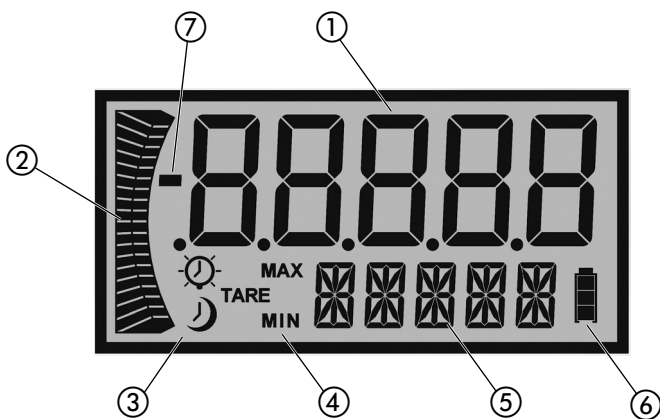

- ① Affichage numérique à 5 chiffres pour la pression.
- ② Graphique à barres de 20 segments – chaque segment représente 5 % de la gamme.
- ③ Symboles de temporisation du rétroéclairage et de mise en veille.
- ④ Icônes de tarage et de pression minimale / maximale.
- ⑤ Afficheur à 5 caractères alphanumériques.
- ⑥ Indicateur à 4 segments de vie des piles.
- ⑦ Indicateur de pression négative.





Remarque : Les appuis de touches courts (moins de 0,5 seconde) sont indiqués par l'icône “”

Les appuis de touches longs (plus de 0,5 seconde) sont indiqués par l'icône “”.

MARCHE / ARRÊT de l'appareil

Appuyez sur la touche   pour mettre l'appareil en MARCHE ou ARRÊT. Lors de la première mise sous tension, l'écran affiche momentanément tous les segments LCD, la version du produit et la pleine échelle de mesure, l'appareil passera ensuite automatiquement en mode Mesure.

Fonction Zéro :

Appuyez sur  . Lorsque la touche est relâchée, l'affichage numérique disparaît momentanément et le terme « ZERO » s'affiche, puis l'appareil retourne au mode Mesure. La pression affichée doit maintenant être 0. La valeur Zéro est stockée en mémoire.

Remarque 1: Le message « RLOCK » affiché indique que le zéro est à plus de $\pm 5\%$ de l'étalonnage d'usine. La mise à zéro est impossible.

Remarque 2: Le message « ZLOCK » indique que la fonction de verrouillage du zéro est activée.



Fonction de tarage :

Soustrait la valeur de la pression actuelle de celle affichée en mode Mesure.

En mode Mesure, appliquez la pression désirée et appuyez sur **ZERO** pour activer la fonction de tarage. Le terme « TARE » clignotera rapidement sur l'afficheur, puis l'icône « TARE » sera affiché et la lecture de la mesure clignotera. L'appareil doit maintenant afficher 0. Appuyez à nouveau sur **ZERO** pour désactiver la fonction de tarage. Le terme « T-OFF » clignotera rapidement sur l'afficheur, puis l'icône « TARE » disparaîtra et la lecture de la mesure ne clignotera plus. L'appareil retourne alors en mode Mesure.



Programmation :

Pour entrer dans le mode Menu

1. Appuyez sur la touche **menu** et relâchez-la pour accéder au mode Programmation.
2. Appuyez sur les flèches pour faire défiler les options de menu programmables.
3. Lorsque l'option voulue est atteinte, appuyez sur **ENTER** pour accéder à ce paramètre.
4. À tout instant, si vous choisissez de quitter (EXIT) le mode Menu (ou sous-menu), maintenez **menu** appuyé. Votre travail ne sera pas sauvegardé.

Paramètres programmables :

Unités de mesure :





1. En mode Menu, appuyez sur les flèches pour faire défiler jusqu'à « UNITS », puis appuyez sur **ENTER**.
2. Choisissez l'unité d'ingénierie en faisant défiler l'affichage, jusqu'à ce que l'unité désirée soit affichée, « PSI, BAR, kg/cm, mPa, ou CUSTM (unités définies par l'utilisateur) ».
3. Appuyez sur **ENTER** pour sélectionner l'unité et retourner au mode Mesure.



Remarque: Programmation des unités définies par l'utilisateur, voir page 24.





Unités de mesure personnalisées :

Permet à l'utilisateur de définir une unité de mesure personnalisée. L'utilisateur doit saisir la valeur de pleine échelle souhaitée de la lecture, ce qui peut être réalisé comme suit.

1. En mode Menu, appuyez sur , ,  sélectionnez « CUSTM », puis appuyez sur , .

2. Position du point décimal :



L'afficheur alphanumérique affichera « SELDP »



Le premier écran affiche tous les chiffres « 5 » et le point décimal le plus à droite se met à clignoter (5 5 5 5.5), sauf si la fonction unité personnalisée a été utilisée auparavant. Si elle a été utilisée, les chiffres et la position du point décimal correspondront au dernier jeu de valeurs. Utilisez les touches , ,  pour déplacer le point décimal à gauche ou à droite. Lorsque le point décimal est à la position souhaitée, appuyez ,  pour le verrouiller à cet emplacement. Lorsque la touche est relâchée, « DIGIT » est affiché.



3. Choisir la valeur de pleine échelle :





L'afficheur alphanumérique affichera « DIGIT ».

L'écran suivant continuera à afficher tous les chiffres 5, avec le chiffre le plus à gauche clignotant et le point décimal à la position précédemment choisie. Toutefois, si la fonction unité personnalisée a été utilisée antérieurement, les chiffres correspondront à la dernière valeur. Le point décimal reste à l'emplacement choisi à l'étape 1. Appuyez sur

, ,  pour modifier la valeur du chiffre (entre 0 et 9).

Lorsque la valeur souhaitée est affichée, verrouillez-la en appuyant sur le bouton , . Le chiffre immédiatement à droite commencera à clignoter. Répétez cette procédure pour les cinq chiffres.

Lorsque ,  est appuyé puis relâché alors que le cinquième chiffre clignote, l'appareil affichera « DONE » (TERMINÉ) brièvement puis retournera au mode Mesure et affichera « CUSTM » en même temps que la lecture numérique pour indiquer que la fonction est utilisée.







L'utilisateur peut quitter la procédure avant que la touche Entrée ne soit appuyée avec la touche , . Si l'utilisateur quitte le menu avec la touche ,  avant d'avoir terminé l'étape 2, ou bien s'il y a eu un délai d'expiration du menu, alors tout ce qui a été précédemment saisi est perdu.

Remarque : Le graphique à barres utilise les paramètres par défaut d'usine lorsque des unités personnalisées sont utilisées.

Remarque : La grandeur de la valeur saisie lors de l'utilisation de la fonction unités personnalisées peut augmenter de façon significative le bruit sur l'écran, ce qui peut affecter les fonctions de zéro et de tarage ainsi que la stabilité de la lecture de la pression affichée. Si nécessaire, consulter l'usine pour les limites recommandées de la pleine échelle de l'entrée.

Maximum / Minimum :

Affiche les valeurs de pression maximum/ minimum, ce qui est initié à la mise sous tension de l'appareil ou dès que les valeurs ont été effacées.







1. En mode Menu, appuyez sur ,  → pour accéder à « Max » (affichage maximum), ce qui est indiqué en petits caractères à la gauche de l'unité de mesure de l'afficheur.
2. Pour effacer les *deux* valeurs Min et Max, appuyez et maintenez la touche  →.
3. Relâcher cette touche vous laissera dans le mode Menu. Utilisez ,  → pour continuer à faire défiler les options du menu, OU maintenez,  → pour retourner au mode Mesure.

Remarque: Effacer les valeurs minimales / maximales se traduira par un écran vide à l'exception de l'icône associé du Min / Max et l'indicateur de la pile.

Remarque: Les actions suivantes effaceront également les valeurs min / max. Mise hors tension, fonction Zéro de l'appareil, fonction de tarage, fonction de calibrage sur le terrain, programmation des unités, le taux de mise à jour ou réinitialisation.

Minuteur :

Contrôle la durée pendant laquelle l'appareil restera allumé (ON) lorsque la touche d'allumage  est appuyée.





1. En mode Menu, appuyez sur ,  → pour faire défiler jusqu'à ce que « TIMER » soit affiché.
2. Appuyez sur  →.
3. Appuyez ensuite sur ,  → pour faire défiler les valeurs. « NONE » indique que l'appareil restera allumé (ON) jusqu'à ce que la touche d'alimentation  soit appuyée une seconde fois. Toute autre valeur (1 min [par défaut] / 5 min / 20 min) autre que « NONE » indiquera la durée pendant laquelle cette fonction sera effective.
4. Appuyez sur  → pour sélectionner la valeur souhaitée ; l'icône minuteur s'affichera et l'appareil indiquera « DONE » (TERMINÉ) puis retournera au mode Mesure.

Particularité : L'icône minuteur clignotera 10 secondes avant que l'appareil ne s'éteigne. Lorsque l'appareil est sous tension, tout appui de touche réinitialisera le minuteur.



Éclairage :

Défini la durée pendant laquelle le rétro-éclairage sera actif (ON) après l'appui de n'importe quelle touche en mode Mesure ou en mode Menu. (Remarque : ce minuteur sera réinitialisé à chaque appui de touche).

1. En mode Menu, appuyez sur ,  → jusqu'à ce que « LIGHT » soit affiché.
2. Appuyez sur  → pour faire apparaître la valeur du minuteur; « ON » se réfère à un rétro-éclairage restant allumé à chaque fois que l'appareil est mis sous tension (ON), « PRESS » indique que le rétro-éclairage est basculé entre Marche et Arrêt (on / off) à chaque appui bref sur la touche  → tandis que, « OFF » indique que le rétro-éclairage restera inactif (éteint). La sélection des valeurs de durée, "1 MIN" (défaut), "5 MIN", "20 MIN", activera le symbole du rétro-éclairage sur l'afficheur LCD pendant la durée indiquée.
3. Appuyez sur  → pour sélectionner la durée du rétro-éclairage (« DONE » sera brièvement affiché) et revenir au mode Mesure.







Remarque : En mode « PRESS »; la temporisation est réglée sur 1 heure en usine pour préserver les piles.

Particularité : L'indicateur du rétro-éclairage clignotera pendant 10 secondes avant que celui-ci ne soit éteint.



Actualisation :

Utilisé pour sélectionner la vitesse de rafraîchissement de la valeur de pression affichée sur l'écran. Cette fonction est utilisée lorsque de rapides changements de pression provoquent un « battement » de l'affichage des valeurs ; un intervalle plus long réduira la vitesse d'actualisation et « moyennera » les lectures sur de telles applications.







1. En mode Menu, appuyez sur ,  → jusqu'à ce que « UPDAT » apparaisse.
2. Appuyez sur  → pour sélectionner.
3. Appuyez sur ,  → pour sélectionner les valeurs parmi « 1 SEC » (défaut), « 500 MSEC », et « 250 MSEC ».
4. Appuyez sur  → pour sélectionner la valeur (« DONE » sera brièvement affiché) et revenir au mode Mesure.

Remarque : Changer la valeur toute valeur autre que 1 sec peut provoquer un léger décalage de zéro, et il est recommandé que l'appareil soit entièrement vidé et remis à zéro avant de prendre des mesures précises. Également, la durée de vie de la pile sera réduite par l'utilisation d'une vitesse de rafraîchissement plus rapide que 1 SEC.



Verrouillage du Zéro (Z-Lock) :

Utilisé pour prévenir une remise à zéro accidentelle de l'appareil.











1. En mode Menu, appuyez sur ,  jusqu'à ce que « Z-LOCK » apparaisse.
2. Appuyez sur  pour sélectionner.
3. Appuyez sur ,  pour sélectionner les valeurs parmi « 1 SEC » (défaut), « 500 MSEC », et « 250 MSEC ».
4. Appuyez sur  pour sélectionner la valeur (« DONE » sera brièvement affiché) et revenir au mode Mesure.

Remarque : Si la fonction Z-Lock est activée, l'appareil affichera « ZLOCK » lors d'une tentative de remise à zéro.



Recalibrage :

Donne à l'utilisateur l'opportunité de calibrer l'appareil sur le terrain. L'étalonnage d'usine original est conservé en mémoire non volatile et peut être rappelé à tout instant.

1. En mode Menu, appuyez sur ,  jusqu'à ce que « RECAL » apparaisse; puis appuyez sur .
2. L'afficheur indiquera « FACT » (usine) « FIELD » (terrain) ou « NEW » (nouveau). Appuyez sur ,  pour faire défiler.
3. Appuyer sur  lorsque « FACT » (usine) est affiché restaurera les valeurs de l'étalonnage d'usine.
4. Appuyer sur  lorsque « FIELD » (terrain) est affiché restaurera les valeurs du dernier étalonnage réalisé sur le terrain.
5. Appuyez sur la touche « Entrée »  lorsque « NEW » (nouveau) est affiché permettra d'entrer dans le mode Recalibrage.
6. Lorsque « NEW » (nouveau) est affiché, appuyez sur ; lorsque vous relâchez la touche, l'affichage suivant clignotera : « OK/ APPLY/ REF/ PSI/ THEN/ PRESS/ ENTER/ TO/ START/ OR/ OTHER/ TO/ ABORT » (OK/ APPLIQUER/ REF/ PSI/ PUIS/ APPUYER/ ENTRÉE/ POUR/ DÉMARRER/ OU/ AUTRE/ POUR/ ABANDONNER). L'afficheur numérique indiquera 00000. Mettez le capteur à l'air libre, puis appuyez sur  l'afficheur indiquera « WAIT » et décomptera à partir de 6 secondes et ensuite affichera CAL brièvement puis ira automatiquement à l'étape suivante.
7. APPLY/ REF/ PSI/ THEN/ PRESS/ ENTER/ TO/ START/ OR/ OTHER/ TO/ ABORT

» clignotera sur l'afficheur ; appliquez alors au manomètre la pleine échelle de pression (en psi) indiquée sur l'afficheur numérique de l'appareil. Appuyez sur  ; l'afficheur indiquera « WAIT » et décomptera à partir de 6 secondes et ensuite affichera CAL brièvement puis ira automatiquement à l'étape suivante.









8. « APPLY/ REF/ PSI/ THEN/ PRESS/ ENTER/ TO/ START/ OR/ OTHER/ TO/ ABORT » clignotera sur l'afficheur ; appliquez alors au manomètre la pression indiquée sur l'afficheur numérique de l'appareil. et appuyez sur  ; l'afficheur indiquera « WAIT » et décomptera à partir de 6 secondes et ensuite affichera GOOD (bon) brièvement puis quittera automatiquement vers le mode Mesure.

Remarque : Le recalibrage n'est autorisé que si les paramètres de test sont dans la plage $\pm 7\%$. En dehors de cette plage, l'afficheur indiquera « CAL FAIL / INPUT PRES TOO LOW (HIGH) / PRESS ENTER TO RETRY / PRESS OTHER TO ABORT » (ÉCHEC CAL/PRESSION D'ENTRÉE TROP BASSE (HAUTE)/ APPUYER ENTRÉE POUR RÉESSAYER/ APPUYER AUTRE POUR ABANDONNER).

Remarque : L'option « FIELD » n'apparaîtra que si l'appareil a été correctement recalibré sur le terrain.

Graphique :

Permet à l'utilisateur de modifier les valeurs de pression qui dictent les indications minimales / maximales sur le graphique à barres à 20 segments.

1. En mode Menu, appuyez sur , , jusqu'à ce que « GRAPH » apparaisse, puis appuyez sur .
2. L'afficheur indiquera « CGOFF » (graphe personnalisé désactivé) [défaut], « CG ON » (graphe personnalisé activé), ou « NEWCG » (nouveau graphe personnalisé). Appuyez sur ,  pour faire défiler.
3. Pour rappeler le dernier graphe personnalisé entré, appuyez sur  lorsque « CG ON » est affiché. « DONE » sera brièvement affiché et l'appareil retournera au mode Mesure.
4. Pour réinitialiser le graphe à barres à la plage de pleine échelle, appuyez sur  lorsque « CGOFF » est affiché. « DONE » sera brièvement affiché et l'appareil retournera au mode Mesure.
5. Pour entrer un nouveau graphe à barres personnalisé; appuyez sur  lorsque « NEWCG » est affiché.
6. Pour programmer le pourcentage minimum du graphe, l'écran affiche 0 0 avec le chiffre de droite clignotant, le



segment le plus bas du graphe à barres clignote et l'écran affiche « PCTFS » (pourcentage de pleine échelle). Appuyez sur ▲, ▼ → pour faire défiler les chiffres 0 à 9. Appuyez sur ⏻ → pour sélectionner ce chiffre. Le chiffre de gauche commencera alors à clignoter. Appuyez sur ▲, ▼ → pour faire défiler les chiffres 0 à 9. Appuyez sur ⏻ → pour sélectionner ce chiffre. Le nombre à 2 chiffres saisi représente le pourcentage de la pleine échelle qui sera utilisé comme extrémité basse du graphe (0 à 99 %).

7. Pour programmer le pourcentage maximum du graphe, l'écran affiche 1 0 0 avec le chiffre de droite clignotant, le segment le plus haut du graphe à barres clignote et l'écran affiche « PCTFS » (pourcentage de pleine échelle). Appuyez sur ▲, ▼ → pour faire défiler les chiffres 0 à 9. Appuyez sur ⏻ → pour sélectionner ce chiffre. Les 2 chiffres de gauche commenceront alors à clignoter. Appuyez sur ▲, ▼ → pour faire défiler les chiffres 0 à 10. Appuyez sur ⏻ → pour sélectionner ce chiffre. Le nombre saisi représente le pourcentage de la pleine échelle qui sera utilisé comme extrémité haute du graphe. Remarque : 100 est le nombre le plus haut et 1 est la seule valeur possible pour le 3ème chiffre. Si le nombre bas est égal ou plus grand que le nombre haut, « REJCT » (rejeté) clignote et l'appareil retournera au sous-menu « GRAPH ».

Remarque : L'affichage d'un message « ULOCK » indique que les unités personnalisées sont en cours d'utilisation et les minimum et maximum du graphe à barres est paramétré aux valeurs d'usine par défaut.

Réinitialisation :

Ramène le produit à ses valeurs d'usine par défaut. Le recalibrage de terrain est préservé. Le calibrage d'usine peut être restauré dans le menu « RECAL ».

En mode Menu, appuyez sur ▲, ▼ → jusqu'à ce que « RESET » apparaisse sur la ligne inférieure de l'afficheur. Appuyez sur ⏻ →.

Les valeurs d'usine par défaut s'appliquent aux unités, minuteur, rétro-éclairage, vitesse de rafraîchissement et verrouillage du zéro.

L'afficheur indiquera « DONE » (effectué) puis l'appareil basculera en condition « OFF » (désactivé).



6.0 REMPLACEMENT DES PILES

L'appareil est alimenté par deux piles alcalines 1,5 volt de type AA. En service normal, la durée de vie des piles est de 2000 heures avant de devoir être remplacées. La durée de vie réelle des piles variera en fonction de l'usage de l'appareil, de la température ambiante et d'autres facteurs.

Remplacez les piles selon la procédure suivante :

1. Faites glisser la gaine de protection (non représentée) hors du boîtier de l'appareil.
2. Agrippez la molette du couvercle arrière et tournez-la dans le sens antihoraire jusqu'à ce que l'icône 'déverrouillé' soit aligné avec la flèche sur le boîtier, à la base du raccord de pression (voir schéma A).
3. Retirez le couvercle en le tirant droit en arrière, puis remplacez les piles comme indiqué, en faisant attention à la polarité de celles-ci (voir schéma B).
4. Pour remettre le couvercle, alignez l'icône 'Unlock' (déverrouillé) avec la flèche sur le boîtier, poussez le couvercle droit en place et tournez dans le sens horaire jusqu'à ce que la flèche soit alignée avec l'icône 'Lock' (verrouillé) (voir schéma C).
5. Réinstallez la gaine de protection (non représentée) sur le boîtier de l'appareil.

Remarque : La réinstallation du couvercle peut provoquer un affichage de pression négatif sur l'appareil. Il s'agit d'un problème temporaire lié à la pression interne du boîtier. Lorsqu'elle sera libérée par l'évent du boîtier, elle s'équilibrera avec la pression atmosphérique (90% du décalage va s'équilibrer dans la minute, les 10% restants peuvent prendre jusqu'à 5 minutes).

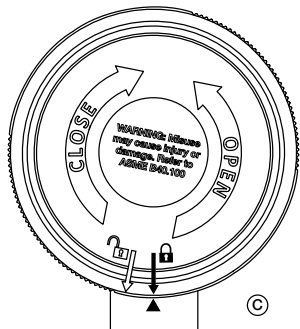
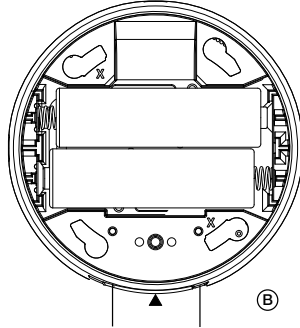
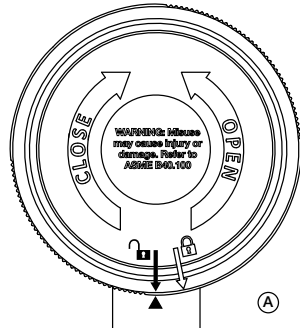

7.0 DONNÉES TECHNIQUES - MODÈLE DGR-2 : MANOMÈTRE NUMÉRIQUE

Dimensions:

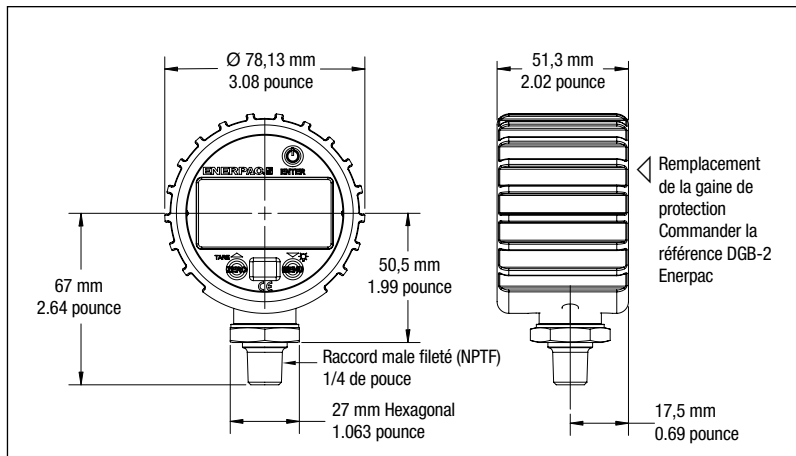

Caractéristiques :

Pression nominale maximale :				Précision	Vitesse de rafraîchissement	Alimentation requise	Poids		Raccord hydraulique	Classement du boîtier
psi	bar	mPa	kg/cm ²				kg	lbs		
20000	1380	140	1400	0.25%	250ms 500ms 1s (sélectionnable par l'utilisateur)	3 volts CC (Deux piles alcalines type AA)	0,23	0.5	Raccord male fileté (NPTF) 1/4 de pouce	IP67
⚠ AVERTISSEMENT : Ne jamais dépasser la pression nominale maximale.										

Caractéristiques environnementales	
	Plage acceptable
Température ambiante de fonctionnement	-20°C à 60°C
Température de l'huile hydraulique	-20°C à 80°C
Température de stockage (piles installées)	-20°C à 60°C
Température de stockage (piles retirées)	-20°C à 80°C
Coefficient de température	-20° C à 180° C [0.04%/ °F] zéro et étendue, température de référence 21° C

Informations de plage et d'intervalle		
Unité de mesure sélectionnée	Plage	Intervalle
psi	0-20000	1
bar	0-1380	0.1
mPa	0-140	0.01
kg/cm ²	0-1400	0.1

Approbations de l'agence
CE EN 61326 (1998) CE EN 61326 Annexe A (industrie lourde) UL/cUL-61010-1 (en attente) Conforme RoHS

CE Cet appareil est conforme aux exigences du marquage CE.

L4009 Rev. A 01/13

1.0 WICHTIGE VERFAHRENSHINWEISE FÜR DEN EMPFANG:

Alle Komponenten auf sichtbare Transportschäden inspizieren. Transportschäden sind nicht von der Garantie gedeckt. Werden solche Schäden festgestellt, ist unverzüglich das Transportunternehmen zu verständigen. Das Transportunternehmen ist für alle Reparatur- und Ersatzkosten, die auf Transportschäden zurückzuführen sind, verantwortlich.

SICHERHEIT GEHT VOR

2.0 SICHERHEITSFRAGEN



Alle Anleitungen, Warnungen und

Vorsichtshinweise

sorgfältig durchlesen. Beachten Sie alle Sicherheitsvorkehrungen, um Verletzungen oder Sachschäden während des Systembetriebs zu vermeiden. Enerpac ist weder für Schäden noch Verletzungen haftbar, die durch einen fahrlässigen Gebrauch des Produkts, mangelhafte Instandhaltung oder eine unvorschriftsmäßige Anwendung des Produkts und/oder des Systems verursacht werden. Bei evtl. Fragen in bezug auf Sicherheitsvorkehrungen und Betriebsabläufe wenden Sie sich bitte an ENERPAC. Wenn Sie an keinerlei Sicherheitsschulungen im Zusammenhang mit Hochdruckhydraulikanlagen teilgenommen haben, fordern Sie von Ihrer Vertriebs- und Kundendienstzentrale einen kostenlosen Enerpac-Hydraulik-Sicherheitskurs an.

Ein Mißachten der folgenden Vorsichtshinweise und Warnungen kann zu Geräteschäden und Verletzungen führen.

Mit einem **VORSICHTSHINWEIS** wird auf ordnungsgemäße Betriebs- oder Wartungsverfahren und -praktiken hingewiesen, um Schäden an den Geräten oder anderen Sachwerten bzw. deren Zerstörung zu vermeiden.

Eine **WARNUNG** verweist auf eine potentielle Verletzungsgefahr, die durch ordnungsgemäße Verfahren oder Praktiken vermieden werden kann.

Ein **GEFAHRENSHINWEIS** wird nur dann gegeben, wenn eine bestimmte Handlung oder die Unterlassung einer bestimmten Handlung schwere oder tödliche Verletzungen zur Folge haben kann.



WARNUNG: Beim Betrieb hydraulischer Anlagen geeignete Schutzkleidung und -ausrüstung tragen.



WARNUNG: Von Lasten fernhalten, die durch ein Hydrauliksystem abgestützt werden. Ein als Lastenhebegerät eingesetzter Zylinder darf niemals als ein Lastenhaltegerät verwendet werden. Nach Heben oder Senken der Last muß diese stets auf mechanische Weise gesichert werden.



WARNUNG ZUM SICHERN VON LASTEN STETS NUR STARRE TEILE VERWENDEN. Zum

Abstützen von Lasten sorgfältig dazu geeignete Stahl- oder Holzblöcke auswählen. Bei Hebe- oder Drückanwendungen keinesfalls einen Hydraulikzylinder als Abstandsstück oder -halter verwenden.



GEFAHR: Zur Vermeidung von Verletzungen während des Betriebs Hände und Füße von Zylinder und Werkstück fernhalten.



WARNUNG: Die zugelassene Nennleistung der Geräte nicht überschreiten. Keine Last zu heben versuchen, deren Gewicht das Hebevermögen des Zylinders übersteigt. Überlasten verursachen Maschinenausfälle und können zu Verletzungen führen. Die Zylinder wurden für einen max. Druck von 700 bar konstruiert. Keinen Heber oder Zylinder an eine Pumpe mit einer höheren nominalen Druckleistung anschließen.



Das Überdruckventil **keinesfalls** auf einen höheren Druck als den maximal zulässigen Druck der Pumpe einstellen. Höhere Einstellungen können zu Geräteschäden und/oder Verletzungen führen.



WARNUNG: Der Systembetriebsdruck darf den zulässigen Nominaldruck der Systemkomponente mit der niedrigsten Nennleistung nicht überschreiten. Zur Überwachung des Betriebsdrucks sind Manometer im System zu installieren. Dies ist das Fenster zu den Abläufen im System.



VORSICHT: Beschädigungen am Hydraulikschlauch vermeiden. Beim Verlegen der Hydraulikschläuche enge Bögen und Abknicken vermeiden. Der Einsatz eines gebogenen oder geknickten Schlauchs führt zu einem hohen Rückstau. Starke Biegungen und Knickstellen schädigen den Schlauch auf der Innenseite und führen zu dessen vorzeitigem Ausfall.



Keine schweren Gegenstände auf den Schlauch fallen lassen. Starke Erschütterungen können Schäden an den im Schlauchinnern verlaufenden Drahtlitzen verursachen. Ein Schlauch, auf den Druck ausgeübt wird, kann bersten.



WICHTIG: Hydraulische Geräte weder an den Schläuchen noch den Gelenkanschlüssen anheben. Dazu den Tragegriff oder eine andere sichere Transportmethode verwenden.



VORSICHT: Hydraulische Geräte von Flammen und Hitzequellen fernhalten. Zu hohe Temperaturen weichen Füllungen und Dichtungen auf und bewirken Flüssigkeitslecks. Große Hitze schwächt außerdem die Schlauchmaterialien und -dichtungen. Zur Gewährleistung einer optimalen Leistung darf die Anlage keinen Temperaturen über 65°C ausgesetzt werden. Außerdem müssen Schläuche und Zylinder beim Schweißen vor Funkenschlag geschützt werden.



GEFAHR: Nicht mit unter Druck stehenden Schläuchen hantieren. Unter Druck austretendes Öl kann in die Haut eindringen und schwere Verletzungen verursachen. Falls Öl unter die Haut gelangt, ist sofort ein Arzt aufzusuchen.



WARNUNG: In einem gekoppelten System dürfen nur Hydraulikzylinder verwendet werden. Niemals einen Zylinder mit unverbundenen Kupplungen verwenden. Bei einer extremen Überbelastung des Zylinders können dessen Komponenten einen Sprungvollausschlag erleiden, was schwere Verletzungen hervorrufen kann.



WARNUNG: Sicherstellen, dass die anlage stabilisiert, bevor eine last angehoben wird. Der Zylinder sollte auf einer ebenen Oberfläche aufsitzen, die fest genug ist, um die Last abzustützen. Wenn möglich einen Zylinderfuß verwenden, um größere Stabilität zu gewährleisten. Keine Schweißarbeiten oder andere Änderungen am Zylinder vornehmen, um einen Zylinderfuß oder andere Abstützungen anzubringen.



Situationen vermeiden, in denen die Lasten nicht direkt über dem Kolben des Zylinders ausgerichtet sind. Seitlich versetzte Lasten führen zu erheblicher Belastung der Zylinder und Kolben. Außerdem könnte die Last ins Rutschen geraten oder fallen, was zu äußerst gefährlichen Situationen führen kann.



Die Last gleichmäßig über die gesamte Fläche des Druckstückes verteilen. Den Kolben immer mit einem Druckstück schützen, wenn keine Zusatzgeräte mit Gewinde benutzt werden.



WICHTIG: Hydraulische Geräte müssen von einem qualifizierten Hydrauliktechniker gewartet werden. Bei Reparaturarbeiten an die autorisierte ENERPAC-Kundendienstzentrale der jeweiligen Region wenden. Zur Aufrechterhaltung der Garantie nur ENERPAC-Öl verwenden.



WARNUNG: Abgenutzte oder beschädigte Teile unverzüglich durch ENERPAC-Originalteile ersetzen. Standardteile anderer Hersteller versagen und verursachen Verletzungen und Sachschäden. ENERPAC-Teile werden so konstruiert, daß sie richtig passen und hohen Lasten standhalten.

3.0 BESCHREIBUNG

Das digitale Manometer DGR-2 von Enerpac ist für die Überwachung von Systemdrücken bis 1380 bar [20.000 psi] geeignet. Zu den Standardfunktionen gehören u.a.:

- Anzeige in mehreren Einheiten verfügbar: psi, bar, mPa und kg/cm² (vom Benutzer auswählbar).
- Zurücksetzen auf Null stellt sicher, dass das Manometer den tatsächlichen Systemdruck misst.
- Wird mit zwei 1,5-V-AA-Batterien (im Lieferumfang enthalten) betrieben.
- Gehäusedesign gemäß Schutzart IP67.
- Vom Benutzer auswählbarer Manometer-Abschalttimer.
- CE- und RoHS-konform.

Hinweis: Genaue Produktspezifikationen und Installationsabmessungen finden Sie in Abschnitt 7.0 dieses Handbuchs.

4.0 INSTALLATIONSINFORMATIONEN

WICHTIG: Um ordnungsgemäßen Betrieb sicherzustellen und einen Ausfall des Manometers zu verhindern, sollten sie die folgende Anleitung und die Vorsichtsmaßnahmen vor Installation des Manometers lesen und verstehen.



WARNUNG: Ein Ausfall, der zu Verletzungen und/oder Sachschäden führt, kann durch zu starken Überdruck, übermäßige Vibration oder Druckschwankungen, zu hohe Instrumententemperatur, Korrosion druckführender Teile oder anderen fehlerhaften Gebrauch verursacht werden. Wenden Sie sich vor Installation des Manometers an Enerpac, wenn Sie Fragen oder Bedenken haben.

Überdruck:

Druckspitzen über dem Nenndruck des Manometers können irreversible elektrische und/oder mechanische Schäden an den Druckmessungs- und druckführenden Elementen verursachen. Druckstöße und -spitzen können Drucksensoren zerstören und müssen grundsätzlich vermieden werden. Ein Druckdämpfer sollte eingebaut werden, um schädliche Stoßeffekte zu beseitigen. Druckstöße treten auf, wenn der Durchfluss plötzlich gestoppt wird, wie bei schnell

schließenden Magnetventilen. Spitzen treten auf, wenn der Durchfluss plötzlich beginnt, zum Beispiel wenn eine Pumpe mit voller Leistung eingeschaltet wird oder ein Ventil schnell geöffnet wird.



WARNUNG: Das Manometer hat einen maximalen Nenndruck von 1380 bar [20.000 psi]. Dieser maximale Nenndruck darf nie überschritten werden.

Druckspitzen:

Spitzen sind besonders schädlich für Manometer, wenn das Rohr ursprünglich leer ist. Um Druckspitzen zu vermeiden, sollten die Flüssigkeitsleitungen (falls möglich) voll bleiben, Pumpen sollten langsam auf Leistung gebracht und Ventile langsam geöffnet werden. Um Schäden durch Druckstöße und -spitzen zu vermeiden, sollte ein Wasserschloss eingebaut werden. Symptome der schädlichen Effekte von Druckstößen und -spitzen:

- Digitales Manometer zeigt große Nullpunktverschiebung.
- Die Druckanzeige des digitalen Manometers bleibt unabhängig vom Druck konstant.
- Fehlercode wird auf dem Bildschirm angezeigt.

Niedrige Temperaturen:

Bildung von Eis am Manometeranschluss kann permanente Schäden am Manometer verursachen. Montieren Sie das Manometer möglichst in vertikaler Position, um mögliche Überdruckschäden aufgrund von Einfrieren zu vermeiden.

Hinweis: Inspezieren Sie das gesamte Hydrauliksystem auf Lecks, wenn vermutet wird, dass Wasser in das System eingedrungen ist. Nehmen Sie die erforderlichen Reparaturen vor, bevor Sie das System wieder in Betrieb nehmen

Installationsanforderungen:







Für das Anziehen des Hydraulikanschlusses des Manometers ist ein 27-mm-Sechskantschlüssel [1-1/16 Zoll] erforderlich. Bringen Sie Teflonband oder eine geeignete Dichtmasse an den 1/4-Zoll-NPTF-Gewinden des Manometers auf. Ziehen Sie mithilfe des Schlüssels 1 Drehung über handfest an oder bis eine lecksichere Dichtung erreicht ist.



⚠ ACHTUNG: Das Anziehen des Manometers durch Anfassen oder Anbringen eines Werkzeugs am Kunststoffgehäuse kann permanente Schäden am Manometer verursachen.

5.0 BEDIENUNGSANWEISUNGEN

Tastatur:

- ① Ein-/Ausschalten / Eingabe 
- ② Null / Pfeil nach oben / Tara  ▲ Tara
- ③ Menüauswahl / Nach unten / Hintergrundbeleuchtungspfeil  ▲ 
- ④ Tastendrucke sind **kurz**  – weniger als 0,5 Sekunden oder **lang**  – mehr als 0,5 Sekunden



LCD-Display und Funktionen:

- ① 5 Ziffern für die Druckanzeige.
- ② Druckbereich-Balkendiagramm mit 20 Segmenten – jedes Segment entspricht 5% des Bereichs.
- ③ Symbole für den Ruhezustands- und Hintergrundbeleuchtungs-Timer-.
- ④ Symbole für maximalen / minimalen Druck und Tara.
- ⑤ Alphanummerische Anzeige mit 5 Zeichen.
- ⑥ Anzeige der Batterielevensdauer mit 4 Segmenten.
- ⑦ Anzeige für negativen Druck.

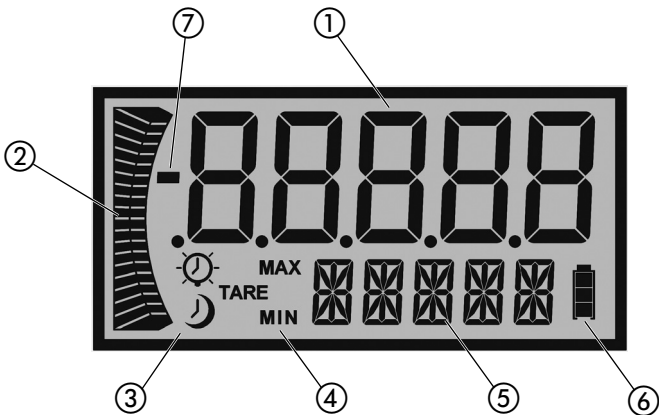



Hinweis: Tastendrücke, die mit kurz (weniger als 0,5 Sek.) bezeichnet sind, sind durch ein „“ -Symbol gekennzeichnet.

Tastendrücke, die mit lang (mehr als 0,5 Sek.) bezeichnet sind, sind durch ein „“ Symbol gekennzeichnet.

Manometer EIN/AUS schalten

Drücken Sie die Taste  , um das Manometer EIN/AUS zu schalten. Beim erstmaligen Einschalten leuchten kurz alle LCD-Segmente auf dem Display und es werden die Produktversion und der volle Skalenbereich angezeigt. Das Gerät geht dann automatisch in den Messmodus.

Nullfunktion:

Drücken Sie  . Nach dem Loslassen verschwindet die Ziffernanzeige kurz und „ZERO“ wird auf dem Buchstabendisplay angezeigt. Anschließend geht das Gerät in den Messmodus. Jetzt sollte ein Druck von 0 angezeigt werden. Der Nullwert wird gespeichert.

Hinweis 1: Die Displaymeldung „RLOCK“ gibt an, dass der Nullwert mehr als $\pm 5\%$ von der werkseitigen Kalibrierung abweicht. Die Nullwerteneinstellung ist nicht möglich.

Hinweis 2: Die Meldung „ZLOCK“ gibt an, dass die Nullwertsperrfunktion aktiviert ist.



Tara-Funktion:

Zieht den aktuellen Druckwert von dem Wert ab, der im Messmodus angezeigt wird..

Wenden Sie im Messmodus den gewünschten Druck auf und drücken Sie **ZERO** um die Tara-Funktion zu aktivieren. Auf dem Display blinkt schnell „TARE“, anschließend wird das „TARE“-Symbol angezeigt und die Druckanzeige blinkt. Jetzt sollte 0 auf dem Gerät angezeigt werden. Drücken Sie erneut **ZERO** um die Tara-Funktion zu deaktivieren. Auf dem Display blinkt schnell „T OFF“, anschließend erlischt das „TARE“-Symbol und die Druckanzeige blinkt nicht mehr. Das Gerät kehrt in den Messmodus zurück.



Programmierung:

Aufrufen des Menümodus

1. Drücken Sie **menu** und lassen Sie die Taste wieder los, um zum Programmiermodus zu gelangen.
2. Drücken Sie **▲**, **▼**, um durch die programmierbaren Menüoptionen zu blättern.
3. Wenn die gewünschte Option erreicht ist, drücken Sie **⏻**, um diesen Parameter aufzurufen.
4. Wenn Sie den Menümodus (oder den Untermenümodus) verlassen möchten, halten Sie **menu** gedrückt. Ihre Arbeit wird nicht gespeichert.

Programmierbare Parameter:

Maßeinheiten:





1. Drücken Sie im Menümodus, **▲**, **▼**, um zu „UNITS“ zu blättern, und drücken Sie **⏻**.
2. Wählen Sie die technischen Einheiten, indem Sie durch **▲**, **▼** blättern, bis die gewünschte Einheit angezeigt wird: PSI, BAR, kg/cm, mPa, vom Kunden definierte Einheiten (CUSTM).
3. Drücken Sie **⏻**, um die Einheiten auszuwählen und zum Messmodus zurückzukehren.

Hinweis: Informationen zum Programmieren benutzerspezifischer Einheiten finden Sie auf Seite 40.





Benutzerspezifische Maßeinheiten:

Ermöglicht es dem Benutzer, eigene Maßeinheiten zu definieren. Der Benutzer muss den vollen Skalenwert der gewünschten Anzeige eingeben. Dies kann wie folgt geschehen.

1. Drücken Sie im Menümodus ,  , wählen Sie „CUSTM“ und drücken Sie  .
2. Wählen Sie die Position des Dezimalzeichens:



Auf dem alphanumerischen Display sollte „SELDP“ angezeigt werden.

Auf dem ersten Bildschirm leuchten alle Ziffern als „5“ und das Dezimalzeichen ganz rechts blinkt (5 5 5 5.5), außer die Funktion für benutzerspezifische Einheiten wurde bereits verwendet. Wenn sie bereits verwendet wurde, sollten die Ziffern und die Position des Dezimalzeichens den zuletzt eingestellten Werten entsprechen. Verwenden Sie die Tasten ,   um das Dezimalzeichen nach links oder rechts zu verschieben. Sobald sich das Dezimalzeichen an der gewünschten Position befindet, drücken Sie   um es zu bestätigen. Wenn Sie die Taste loslassen, wird „DIGIT“ auf dem Display angezeigt.





3. Wählen Sie den vollen Skalenwert:

Auf dem alphanumerischen Display sollte „DIGIT“ angezeigt werden.

Auf dem nächsten Bildschirm werden alle Ziffern als „5“ angezeigt, die Ziffer ganz links blinkt und das Dezimalzeichen befindet sich in der vorher gewählten Position. Wenn die Funktion für benutzerspezifische Einheiten bereits verwendet wurde, sollten die Ziffern dem letzten Wert entsprechen. Das

Dezimalzeichen bleibt an der in Schritt 1 gewählten Position. Drücken Sie ,   um den Wert der Ziffer zwischen 0 und 9 zu ändern.

Sobald der gewünschte Wert angezeigt wird, drücken Sie die Taste  , um ihn zu bestätigen. Jetzt beginnt die nächste Ziffer rechts zu blinken. Wiederholen Sie diesen Vorgang für alle 5 Ziffern. Wenn   gedrückt und losgelassen wird, während die fünfte Ziffer blinkt, zeigt das Manometer kurz „DONE“ an, kehrt in den Messmodus zurück und zeigt „CUSTM“ zusammen mit der numerischen Anzeige an, um anzugeben, dass die Funktion verwendet wird.







Der Benutzer kann den Modus jederzeit vor Drücken der Eingabetaste mit   verlassen. Wenn der Benutzer das Menü mit If the user exits the menu by a   verlässt, bevor Schritt 2 abgeschlossen ist, oder wenn es zu einer Menüzeitüberschreitung kommt, gehen die Eingaben des Benutzers verloren.

Hinweis: Das Balkendiagramm verwendet die werkseitigen Voreinstellungen in Verbindung mit benutzerspezifischen Einheiten.

Hinweis: Die Größenordnung des eingegebenen Werts bei Verwendung der Funktion für benutzerspezifische Einheiten kann das Bildrauschen erheblich steigern, was die Null- und Tara-Funktionen sowie die Stabilität des angezeigten Druckwerts beeinflussen kann. Wenden Sie sich, falls nötig, an das Werk, um die empfohlenen Grenzen bei der vollen Skaleneingabe zu erfahren.

Maximum / Minimum:

Zeigt maximale/minimale Druckwerte an. Dies wird nach Einschalten des Geräts oder nach Löschen der Werte initiiert.







1. Drücken Sie im Menümodus ,  um zu „Max“ (Maximalanzeige) zu blättern. Dies wird in kleiner Schrift links von der Maßeinheit des Displays angezeigt.
2. Um sowohl Min- als auch Max-Werte zu löschen, halten Sie  gedrückt.
3. Wenn Sie diese Taste loslassen, bleiben Sie im Menümodus. Verwenden Sie , , um weiter durch die Menüoptionen zu blättern ODER halten Sie  gedrückt, um zum Messmodus zurückzukehren.

Hinweis: Das Löschen der Minimum/Maximum-Werte führt zu einem leeren Display, mit Ausnahme des zugehörigen Min/Max-Symbols und der Batterieanzeige.

Hinweis: Mit den folgenden Aktionen werden die Min/Max-Werte ebenfalls gelöscht. Ausschalten, Nullstellung des Manometers, Tara-Funktion, Vor-Ort-Kalibrierungsfunktion, Einheitenprogrammierung, Aktualisierungsrate oder Zurücksetzen.

Timer:

Steuert, wie lange das Manometer nach Drücken der Betriebstaste  eingeschaltet bleibt.







1. Drücken Sie im Menümodus,  um bis zur Anzeige von „TIMER“ zu blättern.
2. Drücken Sie .
3. Drücken Sie dann , , um durch die Werte zu blättern. „NONE“ gibt an, dass das Manometer eingeschaltet bleibt, bis die Betriebstaste  ein zweites Mal gedrückt wird. Ein anderer Wert (1 min [Voreinstellung] / 5 min / 20 min) außer „NONE“ gibt an, wie lange diese Funktion wirksam bleibt.
4. Drücken Sie , um den gewünschten Wert auszuwählen. Das Timersymbol wird auf dem Display angezeigt und das Gerät zeigt „DONE“ und kehrt anschließend in den Messmodus zurück.

Funktion: Das Timersymbol blinkt vor dem Abschalten des Manometers 10 Sekunden lang. Während das Manometer eingeschaltet ist, kann der Timer durch Drücken einer beliebigen Taste zurückgesetzt werden.



Beleuchtung:

Legt fest, wie lange die Hintergrundbeleuchtung nach dem Drücken einer Taste im Messungs- oder Menümodus eingeschaltet bleibt (Hinweis: Der Timer wird durch Drücken einer beliebigen Taste zurückgesetzt.)

1. Drücken Sie im Menümodus ,  , bis „LIGHT“ angezeigt wird.
2. Drücken Sie , damit der Timerwert angezeigt wird. „ON“ gibt an, dass die Hintergrundbeleuchtung immer eingeschaltet bleibt, wenn das Gerät eingeschaltet ist. „PRESS“ gibt an, dass die Hintergrundbeleuchtung durch kurzes Drücken von  ein-/ausgeschaltet wird, während „OFF“ angibt, dass die Hintergrundbeleuchtung nie leuchtet. Durch Auswählen der Zeitwerte „1 MIN“ (Voreinstellung), „5 MIN“, „20 MIN“ wird das Hintergrundbeleuchtungssymbol auf dem LCD-Display so lange angezeigt, wie durch die Minuten angeben.
3. Drücken Sie , um die Hintergrundbeleuchtungszeit auszuwählen (auf dem Display wird kurz „DONE“) angezeigt, und kehren Sie zum Messmodus zurück.









Hinweis: Im Modus „PRESS“ ist werkseitig ein Timer von 1 Stunde eingestellt, um die Batterie zu schonen.

Funktion: Die Hintergrundbeleuchtungsanzeige blinkt 10 Sekunden lang, bevor die Beleuchtung ausgeschaltet wird.



Aktualisieren:

Wird verwendet, um die Rate auszuwählen, mit der der angezeigte Druckwert auf dem Bildschirm aktualisiert wird. Diese Funktion wird verwendet, wenn schnelle Änderungen beim Druck ein „Flattern“ bei den Anzeigewerten verursachen. Längere Intervalle verringern die Aktualisierungsrate und „mitteln“ die Werte bei solchen Anwendungen.







1. Drücken Sie im Menümodus ,  , bis „UPDAT“ angezeigt wird.
2. Drücken Sie zum Auswählen .
3. Drücken Sie ,  , um aus den Werten „1 SEC“ (Voreinstellung), „500 MSEC“ oder „250 MSEC“ auszuwählen.
4. Drücken Sie  um den Wert auszuwählen (auf dem Display wird kurz „DONE“ angezeigt), und kehren Sie zum Messmodus zurück.

Hinweis: Wenn Sie einen anderen Wert als 1 Sek. einstellen, kann dies zu einer leichten Nullpunktverschiebung führen. Sie sollten das Manometer dann vollständig entlüften und eine erneute Nullwerteinstellung vornehmen, bevor Sie genaue Werte messen. Außerdem wird die Batteriebensdauer durch Verwendung einer schnelleren Aktualisierungsrate als 1 Sek. verringert.



Z-Sperre:

Wird verwendet, um versehentliche Nullwerteneinstellung des Manometers zu verhindern.











1. Drücken Sie im Menümodus ,  →, bis „ZLOCK“ angezeigt wird.
2. Drücken Sie zum Auswählen  →.
3. Drücken Sie ,  →, um „L ON“ oder „L OFF“ (Voreinstellung) auszuwählen.
4. Drücken Sie  →, um den Wert auszuwählen (auf dem Display wird kurz „DONE“ angezeigt), und kehren Sie zum Messmodus zurück. to select value (display will briefly show “DONE”) and return to Measurement mode.

Hinweis: Wenn die Z-Sperre aktiviert ist, zeigt das Manometer „ZLOCK“, wenn eine Nullwerteneinstellung versucht wird.



Neukalibrierung:

Bietet dem Benutzer die Möglichkeit, das Produkt vor Ort zu kalibrieren. Die ursprüngliche werkseitige Kalibrierung wird dauerhaft im Speicher behalten und kann jederzeit erneut aufgerufen werden.

1. Drücken Sie im Menümodus ,  → bis „RECAL“ angezeigt wird. Drücken Sie anschließend  →.
2. Auf dem Display wird „FACT“ (Werk), „FIELD“ oder „NEW“ angezeigt. Drücken Sie zum Blättern ,  →.
3. Wenn Sie  → drücken, während „FACT“ (Werk) angezeigt wird, werden die Werte der werkseitigen Kalibrierung wiederhergestellt.
4. Wenn Sie  → drücken, während „FIELD“ angezeigt wird, werden die Werte der letzten Vor-Ort-Kalibrierung wiederhergestellt.
5. Wenn Sie die Eingabetaste  → drücken, während „NEW“ angezeigt wird, wird der Neukalibrierungsmodus aufgerufen.
6. Drücken Sie bei der Anzeige von „NEW“  →; Nach Loslassen der Taste blinkt „OK/ APPLY/ REF/ PSI/ THEN/ PRESS/ ENTER/ TO/ START/ OR/ OTHER/ TO/ ABORT“ auf dem Display. Die numerische Anzeige zeigt .00000. Entlüften Sie den Sensor bis zum atmosphärischen Druck, drücken Sie  → Auf dem Display wird „WAIT“ angezeigt und von 6 Sekunden heruntergezählt. Anschließend wird kurz „CAL“ angezeigt und das Gerät geht automatisch zum nächsten Schritt.
7. Auf dem Display blinkt „APPLY/ REF/ PSI/ THEN/ PRESS/ ENTER/ TO/ START/ OR/ OTHER/ TO/ ABORT“. Wenden Sie den vollen Skalendruck in psi-Einheiten, der auf dem numerischen Display angegeben wird, auf

das Manometer auf. Drücken Sie . Auf dem Display wird „WAIT“ angezeigt und das Gerät zählt von 6 Sekunden herunter. Anschließend wird kurz „CAL“ angezeigt und das Gerät geht automatisch zum nächsten Schritt.









8. Auf dem Display blinkt „APPLY/ REF/ PSI/ THEN/ PRESS/ ENTER/ TO/ START/ OR/ OTHER/ TO/ ABORT“. Wenden Sie den auf dem numerischen Display angegebenen Druck auf das Manometer auf und drücken Sie . Auf dem Display wird „WAIT“ und das Gerät zählt von 6 Sekunden herunter. Anschließend wird kurz „GOOD“ angezeigt und das Gerät wechselt in den Messmodus.

Hinweis: Neukalibrierung ist nur erlaubt, wenn die Testparameter innerhalb von $\pm 7\%$ sind. Außerhalb dieses Fensters wird „CAL FAIL / INPUT PRES TOO LOW (HIGH) / PRESS ENTER TO RETRY / PRESS OTHER TO ABORT“ auf dem Display angezeigt.







Hinweis: Die Option „FIELD“ wird nur angezeigt, wenn das Manometer erfolgreich vor Ort neu kalibriert wurde.

Diagramm:

Bietet dem Benutzer die Möglichkeit, die Druckwerte zu ändern, die die Min/Max-Anzeigen über dem Balkendiagramm mit 20 Segmenten vorgeben.

1. Drücken Sie im Menümodus , , bis „GRAPH“ angezeigt wird. Drücken Sie .
2. Auf dem Display wird „CGOFF“ (benutzerspezifisches Diagramm aus) [Voreinstellung], „CG ON“ (benutzerspezifisches Diagramm ein) oder „NEWCG“ (neues benutzerspezifisches Diagramm) angezeigt. Drücken Sie zum Blättern , .
3. Um das letzte benutzerspezifische Diagramm erneut aufzurufen, das bei der Anzeige von „CG ON“ eingegeben wurde, wählen Sie . Auf dem Display wird kurz „DONE“ angezeigt und das Gerät kehrt in den Messmodus zurück.
4. Um das Balkendiagramm bei Anzeige von „CGOFF“ auf den vollen Skalenbereich zurückzusetzen, drücken Sie . Auf dem Display wird kurz „DONE“ angezeigt und das Gerät kehrt in den Messmodus zurück.
5. Um bei der Anzeige von „NEWCG“ ein neues Balkendiagramm einzugeben, drücken Sie .



6. Beim Programmieren eines minimalen Diagrammprozensatzes wird auf dem Display 0 0 angezeigt, wobei die rechte Ziffer und das unterste Segment des Balkendiagramms blinkt. Auf dem Display wird „PCTFS“ (Prozensatz volle Skala) angezeigt. Drücken Sie ,  um zu einer Zahl von 0 bis 9 zu blättern. Drücken Sie  um diese Zahl auszuwählen. Die linke Ziffer beginnt jetzt zu blinken. Drücken Sie ,  um zu einer Zahl von 0 bis 9 zu blättern. Drücken Sie  um diese Zahl auszuwählen. Die eingegebene 2-stellige Zahl stellt den Prozentsatz der vollen Skala dar, der als unteres Ende des Diagramms verwendet wird (0 - 99%).



7. Beim Programmieren eines maximalen Diagrammprozensatzes der vollen Skala wird auf dem Display 1 0 0 angezeigt, wobei die rechte Ziffer und das oberste Segment des Balkendiagramms blinkt. Auf dem Display wird „PCTFS“ (Prozensatz volle Skala) angezeigt. Drücken Sie ,  um zu einer Zahl von 0 bis 9 zu blättern. Drücken Sie  um diese Zahl auszuwählen. Die linken 2 Ziffern beginnen jetzt zu blinken. Drücken Sie ,  um zu einer Zahl von 0 bis 10 zu blättern. Drücken Sie  um diese Zahl auszuwählen. Die eingegebene Zahl stellt den Prozentsatz der vollen Skala dar, der als oberes Ende des Diagramms verwendet wird. Hinweis: 100 ist die höchste Zahl und es ist nur eine 3-stellige Zahl möglich. Wenn die niedrigste Zahl gleich oder größer als die höchste Zahl ist, blinkt „REJECT“ auf dem Gerät und es geht zum Untermenü „GRAPH“ zurück.

Hinweis: Die Displaymeldung „UNLOCK“ gibt an, dass benutzerspezifische Einheiten

verwendet werden und dass das Minimum und Maximum des Balkendiagramms auf die werkseitigen Voreinstellungen eingestellt ist.

Zurücksetzen:

Setzt das Produkt auf die werkseitig voreingestellten Werte zurück. Behält die Vor-Ort-Kalibrierung bei. Die werkseitige Kalibrierung kann im Menü „RECAL“ wiederhergestellt werden.

Drücken Sie im Menümodus ,  um bis „RESET“ auf der unteren Displayzeile angezeigt wird. Drücken Sie .

Die werkseitigen Einstellungen beziehen sich auf Einheiten, Timer, Hintergrundbeleuchtung, Aktualisierungsrate, Nullsperr.

Auf dem Display wird „DONE“ angezeigt und das Manometer schaltet auf „OFF“.



6.0 BATTERIEAUSTAUSCH

Das Manometer wird mit zwei 1,5-V-Alkalibatterien des Typs AA betrieben. Bei normalem Betrieb halten die Batterien ca. 2.000 Stunden, bevor sie ausgetauscht werden müssen. Die tatsächliche Batterielebensdauer hängt von der Nutzung des Manometers, der Umgebungstemperatur und anderen Faktoren ab.

Tauschen Sie die Batterien wie folgt aus:

1. Schieben Sie die Schutzabdeckung (nicht abgebildet) vom Manometergehäuse.
2. Fassen Sie die gerändelte Abdeckung und drehen Sie sie entgegen dem Uhrzeigersinn, bis das „Entriegeln“-Symbol mit dem Pfeil ausgerichtet ist. Es befindet sich unten am Druckanschluss am Gehäuse (siehe Abb. A).
3. Entfernen Sie die Abdeckung, indem Sie sie gerade zurückziehen, und tauschen sie die AA-Alkalibatterien aus. Achten Sie auf die richtige Polarität der Batterien (siehe Abb. B).
4. Um die Abdeckung wieder anzubringen, richten Sie das „Entriegeln“-Symbol mit dem Pfeil aus, schieben die Abdeckung gerade hinein und drehen sie im Uhrzeigersinn, bis der Pfeil mit dem „Verriegeln“-Symbol ausgerichtet ist (siehe Abb. C).
5. Bringen Sie die Schutzabdeckung (nicht abgebildet) wieder am Manometergehäuse an.

Hinweis: Das Wiederanbringen der Abdeckung kann dazu führen, dass das Manometer einen negativen Druck anzeigt. Dies ist ein vorübergehendes Problem, da der interne Gehäusedruck durch Entlüftung des Gehäuses verringert wird und sich an den atmosphärischen Druck angleicht (90%

der Verschiebung gleicht sich innerhalb einer Minute an, die restlichen 10% können bis zu 5 Minuten dauern).

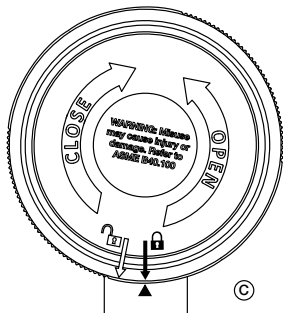
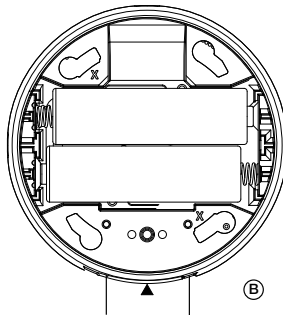
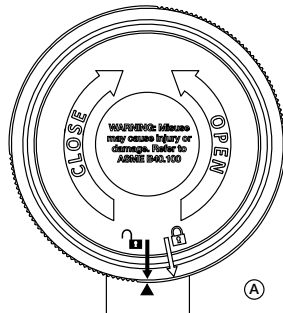

7.0 TECHNISCHE DATEN - DIGITALES MANOMETER MODELL DGR-2

Abmessungen:

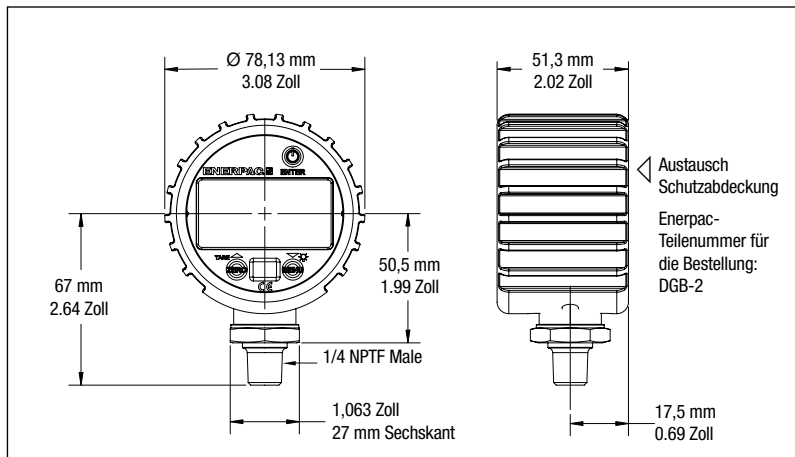

Technische Daten:

Maximaler Nenndruck:				Genauigkeit	Aktualisierungsrate	Strombedarf	Gewicht		Hydraulikanschluss	Gehäuse-Schutzart
psi	bar	mPa	kg/cm ²				kg	lbs		
20000	1380	140	1400	0,25%	250ms 500ms 1s (vom Benutzer auswählbar)	3 volts CC (zwei AA- Alkalibatterien)	0,23	0,5	1/4 NPTF Male	IP67
⚠️ WARNUNG: Der maximale Nenndruck darf nie überschritten werden.										

Umgebungsdaten	
	Zulässiger Bereich
Umgebungstemperatur (Betrieb)	-20°C bis 60°C
Temperatur des Hydrauliköls	-20°C bis 80°C
Lagertemperatur (mit eingelegten Batterien)	-20°C bis 60°C
Lagertemperatur (ohne Batterien)	-20°C bis 80°C
Temperaturkoeffizient	-20 °C bis 180 °C [0,04%/°F] Nullpunkt und Spanne, Referenztemperatur 21 °C [70 °F]

Bereichs- und Intervallinformationen		
Ausgewählte Maßeinheit	Bereich	Intervall
psi	0-20000	1
bar	0-1380	0.1
mPa	0-140	0.01
kg/cm ²	0-1400	0.1

Zulassungen
CE EN 61326 (1998) CE EN 61326 Anhang A (Schwerindustrie) UL/cUL-61010-1 (ausstehend) RoHS-konform

CE Dieses Gerät erfüllt die Anforderungen der CE-Kennzeichnung

L4009 Rev. A 01/13

1.0 NOTA IMPORTANTE

Ispezionare visivamente tutti i componenti per identificare eventuali danni di spedizione e, se presenti, avvisare prontamente lo spedizioniere. I danni subiti durante la spedizione non sono coperti dalla garanzia vigente. Lo spedizioniere è il solo responsabile per i costi di riparazione o di sostituzione conseguenti a danni avvenuti durante la spedizione.

SICUREZZA ANZITUTTO

2.0 INFORMAZIONI SULLA SICUREZZA



Leggere attentamente tutte le istruzioni, le avvertenze e le precauzioni. Durante il funzionamento del sistema, rispettare tutte le norme di sicurezza onde evitare infortuni o danni all'apparecchiatura. L'Enerpac declina ogni responsabilità per danni risultanti da un uso improprio del prodotto, dalla mancata manutenzione o dall'applicazione errata del prodotto e del sistema. In caso di dubbio in materia di sicurezza o applicazioni, rivolgersi all'Enerpac. Se si richiedono informazioni sulle norme di sicurezza per sistemi idraulici ad alta pressione, rivolgersi al distributore o al centro di riparazione di zona in grado di fornire gratuitamente un corso di addestramento in materia di sicurezza idraulica autorizzato dalla Enerpac.

La mancata osservanza delle seguenti precauzioni potrebbe portare a seri danni all'apparecchiatura e a lesioni personali.

Una **PRECAUZIONE** indica le corrette procedure di azionamento o manutenzione per evitare danni all'apparecchiatura o all'ambiente circostante.

Un'**AVVERTENZA** indica un potenziale pericolo che richiede la messa in pratica delle procedure corrette per evitare infortuni.

Un **PERICOLO** indica una situazione in cui un'azione o la mancanza di azione può causare gravi lesioni personali se non il decesso.



AVVERTENZA: Indossare un'attrezzatura di protezione appropriata durante il funzionamento dell'apparecchiatura.



AVVERTENZA: Stare lontano da carichi sospesi e sostenuti idraulicamente. Un cilindro utilizzato per sollevare un carico non deve mai essere impiegato anche per il loro sostegno. Dopo aver alzato o abbassato un peso, è necessario che questo venga sempre bloccato in maniera meccanica.



AVVERTENZA: UTILIZZARE SOLO ATTREZZI RIGIDI PER IL SOSTEGNO DEI CARICHI.

Selezionare con cura blocchi in acciaio o in legno capaci di supportare il peso del carico. Non ricorrere mai a un cilindro idraulico come cuneo o spessore in applicazioni di sollevamento o pressatura.



PERICOLO: Per evitare lesioni personali, durante la lavorazione tenere le mani e i piedi lontano dal cilindro e dal pezzo in lavorazione.



AVVERTENZA: Non superare mai la capacità nominale dell'apparecchiatura. Non tentare mai di sollevare un peso superiore alla capacità del cilindro, dato che il sovraccarico può causare guasti all'apparecchiatura e possibili infortuni all'operatore. I cilindri sono stati studiati per una pressione massima pari a 700 bar. Non collegare un martinetto o un cilindro a una pompa la cui pressione nominale è superiore.



Non impostare mai la valvola di scarico a una pressione superiore a quella massima nominale della pompa. Un'impostazione superiore può

arrecare danni all'apparecchiatura e/o provocare infortuni all'operatore.



AVVERTENZA: La pressione di esercizio del sistema non deve superare il valore nominale prefissato per il componente dalla pressione più bassa. Installare nel sistema un manometro per tenere sotto controllo la pressione di esercizio.



PRECAUZIONE: Evitare di arrecare danni al tubo idraulico flessibile. Evitare di piegare o arricciare il tubo flessibile durante l'uso, poiché gli strozzature possono provocare gravi contropressioni. Le piegature e gli strozzature acute possono danneggiare internamente il tubo flessibile e provocarne quindi un guasto prematuro.



Non lasciar cadere oggetti pesanti sul tubo flessibile, dato che l'impatto potrebbe danneggiarne i fili dell'armatura. La messa sotto pressione di un tubo flessibile danneggiato può causarne la rottura.



IMPORTANTE: Non sollevare apparecchiature idrauliche mediante il tubo flessibile o i giunti orientabili. Servirsi della maniglia per trasporto o di un altro mezzo di trasporto sicuro.



PRECAUZIONE: Tenere l'apparecchiatura idraulica lontano da fiamme e sorgenti di calore. Il calore eccessivo ammorbidisce le guarnizioni, provocando perdite di fluido. Il calore indebolisce altresì il materiale di cui è composto il tubo flessibile. Per garantire le migliori prestazioni, non esporre l'apparecchiatura a temperature superiori a 65°C (150°F). Proteggere i tubi flessibili e i cilindri da scintille o scaglie di saldatura.



PERICOLO: Non maneggiare i tubi flessibili sotto pressione. Eventuali fuoriuscite d'olio sotto pressione possono penetrare sotto la cute e provocare gravi lesioni. Se l'olio penetra sotto la pelle, rivolgersi immediatamente a un medico.



AVVERTENZA: Utilizzare i cilindri idraulici solo se i giunti del sistema sono debitamente accoppiati. Se il sovraccarico del cilindro diventa eccessivo, i componenti possono guastarsi irrimediabilmente e provocare gravi lesioni personali.



AVVERTENZA: Prima di sollevare il carico, assicurarsi che la configurazione dell'intera apparecchiatura sia perfettamente stabile. Il cilindro deve essere disposto su una superficie piana, in grado di sostenere il carico. Se possibile, usare una base per il cilindro, per aumentarne la stabilità. Non saldare né modificare in alcun modo il cilindro allo scopo di collegarvi una base o un altro supporto.



Evitare situazioni in cui i carichi non siano perfettamente centrati rispetto allo stelo del cilindro stresso. I carichi disassati esercitano notevoli sollecitazioni sui cilindri e steli. Inoltre, il carico potrebbe scivolare o cadere, con risultati potenzialmente pericolosi.



Distribuire il carico uniformemente sull'intera superficie della testa del pistone. Usare sempre una testina per proteggere lo stelo quando non si usano attacchi filettati.



IMPORTANTE: Affidare la manutenzione delle apparecchiature idrauliche solamente a un tecnico specializzato. Per richiedere un intervento di assistenza, rivolgersi al centro di assistenza ENERPAC autorizzato di zona. Per usufruire dei termini di garanzia, utilizzare esclusivamente olio idraulico ENERPAC.



AVVERTENZA: Sostituire immediatamente le parti usurate o danneggiate con pezzi di ricambio ENERPAC originali. I pezzi di ricambio di qualità standard si potrebbero rompere più facilmente e arrecare danni alla propria persona e all'ambiente circostante. I pezzi di ricambio ENERPAC sono stati concepiti per adattarsi perfettamente al sistema e per sopportare condizioni di carico elevate.

3.0 DESCRIZIONE

Il manometro digitale Enerpac DGR-2 è stato progettato per monitorare la pressione del sistema fino a un valore di 20000 psi [1380 bar]. Le caratteristiche standard comprendono:

- Schermate disponibili in diverse unità: psi, bar, mPa e kg/cm² (selezionabili dall'utente).
- La funzione Reimpostare l'azzeramento garantisce che il manometro legga la pressione reale dell'impianto.
- Alimentato tramite due batterie AA da 1.5V (incluse).
- Il design del involucro ha ottenuto la classificazione IP67.
- Il temporizzatore per lo spegnimento del manometro è programmabile dall'utente.
- Rispetta le norme CE e RoHS.

NOTA: Per i dettagli delle specifiche di prodotto e delle dimensioni dell'installazione fare riferimento alla Sezione 7 di questo manuale.

4.0 INFORMAZIONI DI INSTALLAZIONE

IMPORTANTE: Per garantire il corretto funzionamento e contribuire a prevenire guasti, si prega di leggere e comprendere le seguenti istruzioni e precauzioni prima di installare il manometro.



AVVERTENZA: Una pressione troppo alta, eccessive vibrazioni o pulsazioni, una temperatura troppo alta o la corrosione delle parti interne dello strumento possono causare guasti che possono provocare danni a persone e/o alle cose. Per eventuali dubbi consultare Enerpac prima di installare il manometro.

Sovratensione:

Picchi troppo elevati di pressione possono provocare danni elettrici e/o meccanici irreversibili alle parti interne del manometro. Il colpo d'ariete e la sovratensione possono distruggere i trasduttori e vanno sempre evitati. Per eliminare gli effetti dannosi del colpo d'ariete deve essere installato un soppressore di pressione. Il colpo d'ariete si verifica quando il flusso di un liquido viene repentinamente bloccato, ad esempio chiudendo velocemente le valvole solenoidi.

Le sovratensioni si verificano quando il flusso viene repentinamente aperto, ad esempio aprendo una pompa alla massima potenza o aprendo velocemente una valvola.



AVVERTENZA: Il manometro è tarato a una pressione massima di 20.000 psi (1380 bar). Non superare mai il valore massimo di pressione.

Sovratensioni:

Le sovratensioni danneggiano i manometri soprattutto se il tubo è inizialmente vuoto. Per evitare sovratensioni, le tubature devono essere piene (se possibile), le pompe devono essere aperte aumentando gradualmente la potenza e le valvole devono essere aperte lentamente. Per evitare danni da colpi d'ariete e da sovratensioni, deve essere installata una camera di depressione. I segni degli effetti dannosi dei colpi d'ariete e delle sovratensioni sono:

- Il manometro digitale visualizza una grande deviazione zero.
- Il valore di pressione visualizzato dal manometro rimane costante indipendentemente dalla pressione
- Viene visualizzato un codice di errore.

Basse temperature:

La formazione di ghiaccio nella presa di pressione può provocare danni permanenti al manometro. Quando possibile, montare il manometro in posizione verticale per evitare possibili danni da sovratensione dovuti al freddo.

Nota: Ispezionare l'intero impianto idraulico per individuare crepe qualora vi sia il sospetto di infiltrazioni d'acqua nel sistema. Effettuare le necessarie riparazioni prima di riavviare l'impianto.

Requisiti di Installazione:

Per fissare il manometro al giunto idraulico occorre una chiave inglese esagonale di 1-1/16 pollici (27 mm). Applicare un nastro di teflon o un composto sigillante ai filetti NPTF da 1/4 di pollice del manometro. Durante l'uso della chiave inglese, stringere dando un giro stretto o fino a ottenere un sigillo a prova di crepa.



PRECAUZIONE: Fissare il manometro stringendolo con le mani o inserendo uno strumento nell'alloggiamento di plastica può provocare danni permanenti al manometro.

5.0 ISTRUZIONI DI FUNZIONAMENTO

Tastiera:

- ① Acceso-Spento / Invio 
- ② Zero / Freccia in alto / Tara  ▲ Tara
- ③ Selezione Menu / Freccia in Giù / Retroilluminazione  ▲ 
- ④ La pressione dei tasti è **breve**  (inferiore a 0.5 secondi)
o **lunga**  (superiore a 0.5 secondi)



Schermo LCD e funzioni:

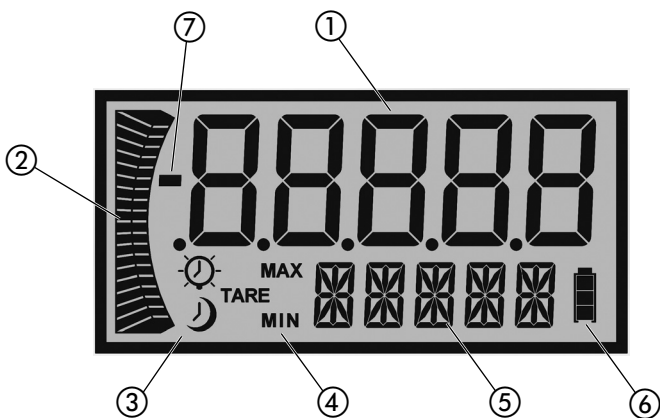

- ① Visualizzazione del valore della pressione a 5 cifre.
- ② Grafico a barre costituito da 20 segmenti che rappresentano la gamma dei valori della pressione - ogni segmento rappresenta il 5% della gamma.
- ③ Simboli di Sospensione e del temporizzatore della retroilluminazione.
- ④ Icone che rappresentano la pressione massima/minima e la tara.
- ⑤ Schermo da 5 caratteri alfanumerici.
- ⑥ Indicatore di carica delle batterie a 4 segmenti.
- ⑦ Indicatore della pressione negativa.





Nota: Le pressioni dei tasti indicate come brevi (meno di 0.5 sec) sono rappresentate dall'ICONA "↶→".

Le pressioni dei tasti indicate come lunghe (più di 0.5 sec.) sono rappresentate dall'icona "↶→".

Accensione/spengimento

Premere il tasto   per accendere/spengere il manometro. Al momento dell'accensione, lo schermo visualizza momentaneamente tutti i segmenti LCD, la versione del prodotto e l'intero grafico di gamma; l'unità passerà quindi alla modalità Misurazione.

Funzione di azzeramento:

Premere  . Quando si rilascia il pulsante, la visualizzazione numerica scompare momentaneamente e viene visualizzata la scritta "ZERO" quindi il sistema ritorna alla modalità Misurazione. Ora il valore della pressione che viene letto dovrebbe essere 0. Il valore di azzeramento viene salvato in memoria.



Nota 1: Il messaggio "RLOCK" indica che il valore zero si allontana di oltre il $\pm 5\%$ dalla taratura di fabbrica. L'azzeramento non è possibile.

Nota 2: Il messaggio "ZLOCK" indica che la funzione di blocco dell'azzeramento è attiva.



Funzione di Tara:





Il valore della pressione attuale dal valore visualizzato in modalità Misurazione.

In modalità Misurazione, applicare la pressione desiderata e premere **ZERO** , per attivare la funzione di tara. Sullo schermo apparirà velocemente la scritta "TARE", quindi comparirà l'icona "TARE" e il valore della pressione appena letto lampeggerà. L'unità dovrebbe visualizzare 0. Premere **ZERO**  di nuovo per disattivare la funzione di tara. Sullo schermo apparirà velocemente la scritta "T OFF", quindi l'icona "TARE" scomparirà e il valore della pressione appena letto smetterà di lampeggiare. L'unità ritornerà alla modalità Misurazione.







Programmazione:

Per accedere alla modalità Menu

1. Premere **menu**  e rilasciarlo per passare alla modalità Programmazione.
2. Premere **▲**, **▼** , per scorrere fra le opzioni del menù programmabile.
3. Una volta trovata l'opzione desiderata, premere **power**  per accedere a quel parametro.
4. Se in qualsiasi momento si sceglie di USCIRE dalla modalità Menu (o Submenù), premere **menu** . Il lavoro non verrà salvato.

Parametri programmabili:

Unità di Misura:





1. In modalità Menu, premere **▲**, **▼**  per scorrere fino a "UNITS", premere **power** .
2. Selezionare l'unità metrica scorrendo **▲**, **▼** , fino alla visualizzazione dell'unità desiderata, "PSI, BAR, kg/cm, mPa, unità definite dall'utente (CUSTM)".
3. Premere **power**  per selezionare le unità e tornare alla modalità Misurazione.

Nota: Programmazione personalizzata delle unità, vedi pag. 56.





Unità di misura personalizzate::

Permette all'utente di definire un'unità di misura personalizzata. L'utente deve immettere l'intera scala dei valori che desidera leggere, procedendo come segue.

1. In modalità Menu premere ,  ➡, selezionare "CUSTM", premere , .
2. Selezionare la posizione del separatore decimale:



La schermata alfanumerica dovrà visualizzare la scritta "SELDP"



La prima schermata visualizzerà tutte le cifre illuminate come "5" e il separatore decimale posizionato più a destra lampeggerà (5 5 5 5.5) a meno che questa funzione non sia stata utilizzata in precedenza. Se essa è già stata utilizzata, le cifre e la posizione del separatore decimale devono corrispondere agli ultimi valori impostati. Usare i tasti ,  ➡, per spostare il separatore decimale a sinistra o a destra. Quando il separatore decimale si trova nella posizione desiderata, premere  ➡ per bloccarlo in quella posizione. Quando il tasto viene rilasciato, sullo schermo appare la scritta "DIGIT".



3. Scegliere la scala di valori completa::

La schermata alfanumerica dovrà visualizzare la scritta "DIGIT"

La schermata successiva continuerà a visualizzare tutte le cifre illuminate come "5", il numero posizionato più a destra lampeggerà e il separatore decimale si troverà nella posizione precedentemente selezionata. Comunque, se questa funzione è stata utilizzata in precedenza, le cifre corrisponderanno all'ultimo

valore selezionato. Il separatore decimale rimarrà nella posizione selezionata nel passo 1 Premere ,  ➡ per cambiare il valore delle cifre in una scala da 0 a 9.

Quando viene visualizzato il valore desiderato, premere il tasto  ➡ per bloccarlo in quella posizione. La cifra successiva sulla destra inizierà a lampeggiare. Ripetere la procedura per tutte le 5 cifre. Quando viene premuto e rilasciato il tasto  ➡ e la quinta cifra lampeggia, il manometro visualizza brevemente la scritta "DONE" quindi ritorna alla modalità Misurazione e visualizza la scritta "CUSTM" insieme alla lettura numerica: questo significa che la funzione è in uso.







L'utente può uscire in qualsiasi momento prima di premere il tasto "Invio" con  ➡. Se l'utente esce dal menù tramite a  ➡ prima di completare il passo 2, o in caso di timeout del menù, i dati immessi dall'utente verranno persi.

Nota: Il grafico a barre usa le impostazioni predefinite di fabbrica quando viene usata la funzione di personalizzazione delle unità.

Nota: La grandezza del valore immesso quando si usa la funzione di personalizzazione delle unità può aumentare sensibilmente le interferenze sullo schermo, il che può influire sulla funzione di azzeramento e sulla funzione di tara, nonché sulla stabilità del valore della pressione che viene visualizzato. Se necessario, consultare la casa produttrice per conoscere le limitazioni consigliate riguardo l'immissione della scala.

Massimo / Minimo:

Visualizza i valori massimi/minimi della pressione; questa funzione si avvia all'accensione dell'unità o quando i valori vengono cancellati.







1. In modalità Menu, premere ,  per scorrere fino a 'Max' (valore massimo); questo è indicato in minuscolo a sinistra dell'unità di misura visualizzata.
2. Per cancellare entrambi i valori Min e Max, premere e tenere premuto il tasto  zero
3. Rilasciando il tasto si rimane in modalità Menu. Usare i tasti ,  per continuare a scorrere fra le opzioni del menu, o tenere premuti i tasti  menu per tornare alla modalità Misurazione.

Nota: La cancellazione dei valori Minimo / Massimo restituirà una schermata vuota, fatta eccezione per le relative icone Min./Max. e per l'indicatore di carica della batteria.

Nota: Anche le seguenti azioni comportano la cancellazione dei valori minimo/massimo: spegnimento, funzione di azzeramento, funzione della tara, funzione di taratura sul campo, programmazione delle unità, aggiornamento dei valori o reimpostazione.

Temporizzatore:

Controlla il tempo in cui il manometro resterà acceso mentre viene premuto il tasto .





1. In modalità Menu, premere ,  per scorrere fino a quando viene visualizzata la scritta "TIMER".
2. Premere  per selezionare il valore desiderato.
3. Quindi, premere ,  per scorrere fra i valori. "NONE" indica che il manometro rimarrà ACCESO fino a quando il tasto  di accensione verrà premuto una seconda volta. Ogni altro valore (1 min [default] / 5 min / 20 min), piuttosto che "NONE", indica la durata del tempo in cui questa funzione è attiva.
4. Premere  per selezionare il valore desiderato; l'icona del temporizzatore apparirà sullo schermo e l'unità visualizzerà la scritta "DONE" quindi tornerà alla modalità Misurazione.

Funzione: L'icona del temporizzatore lampeggerà per 10 secondi prima dello spegnimento del manometro. Quando il manometro è acceso, qualsiasi tasto premuto reimposta il temporizzatore.



Illuminazione:

Determina il lasso di tempo in cui la retroilluminazione rimarrà ACCESA dopo la pressione di qualsiasi tasto nelle modalità Misurazione o Menu (Nota: Il temporizzatore viene reimpostato con la pressione di qualsiasi tasto.)

1. In modalità Menu, premere ,  ➔ fino a quando verrà visualizzata la scritta "LIGHT".
2. Premere  ➔ per visualizzare il valore del temporizzatore; "ON" indica che la retroilluminazione rimane ACCESA ogni qualvolta l'unità è ACCESA, "PRESS" indica che la retroilluminazione viene accesa/spenta premendo brevemente il tasto di retroilluminazione  ➔ mentre "OFF" indica che la retroilluminazione non è mai accesa. Selezionando i valori del tempo, "1 MIN" (default), "5 MIN", "20 MIN", si attiva il simbolo della retroilluminazione sullo schermo per il numero di minuti indicato.
3. Premere  ➔ per selezionare il tempo di durata della retroilluminazione (sullo schermo apparirà per breve tempo la scritta "DONE").







Nota: In modalità "PRESS"; la casa produttrice ha impostato un temporizzatore per 1 ora di tempo per risparmiare la batteria.

Funzione: L'indicatore della retroilluminazione lampeggerà per 10 secondi prima dello spegnimento della luce.



Aggiornamento:

Utilizzato per selezionare la velocità con cui il valore della pressione visualizzato verrà aggiornato sullo schermo. Questa funzione viene utilizzata quando dei rapidi cambiamenti di pressione causano "turbamenti" nei valori visualizzati; intervalli più lunghi ridurranno la velocità di aggiornamento e "livelleranno" le letture in queste applicazioni.







1. In modalità Menu, premere ,  ➔ fino a quando apparirà la scritta "UPDAT".
2. Premere  ➔ per selezionare.
3. Premere ,  ➔ per selezionare i valori per "1 SEC" (default), "500 MSEC", o "250 MSEC".
4. Premere  ➔ per selezionare il valore (sullo schermo apparirà per breve tempo la scritta "DONE") e tornare alla modalità Misurazione.

Nota: Selezionare un valore diverso da 1 sec può causare una leggera deviazione da zero; si raccomanda di aerare completamente il manometro e riazzerarlo prima di prendere letture precise. La durata della batteria si riduce anche utilizzando una velocità di aggiornamento superiore a 1 secondo.



Z-Lock:

Utilizzato per impedire il riassetto del manometro.











1. In modalità Menu, premere ,  fino a quando apparirà la scritta "ZLOCK".
2. Premere  per selezionare.
3. Premere ,  per selezionare "L ON" o "L OFF" (default).
4. Premere  per selezionare il valore (sullo schermo apparirà per breve tempo la scritta "DONE") e tornare alla modalità Misurazione.

Nota: Se la funzione Z-Lock è attiva, sullo schermo del manometro apparirà la scritta "ZLOCK" in caso di tentativo di azzeramento.



Ritaratura:

Fornisce all'utente la possibilità di tarare sul campo il prodotto. La taratura originale di fabbrica risiede permanentemente in memoria e può essere richiamata in qualsiasi momento.

1. In modalità Menu premere ,  fino a quando apparirà la scritta "RECAL" quindi premere  .
2. Lo schermo indicherà "FACT" (fabbrica) "FIELD" o "NEW". Premere ,  per scorrere.
3. Premendo  mentre è visualizzata la scritta "FACT" (fabbrica) verranno ripristinati i valori della taratura di fabbrica.
4. Premendo  mentre è visualizzata la scritta "FIELD" verranno ripristinati i valori dell'ultima taratura sul campo.
5. Premendo il tasto "Invio"  quando appare la scritta "NEW" si entrerà in modalità Ritaratura.
6. Quando viene visualizzata la scritta "NEW", premere  ; una volta rilasciato, sullo schermo lampeggerà la scritta "OK/ APPLY/ REF/ PSI/ THEN/ PRESS/ ENTER/ TO/ START/ OR/ OTHER/ TO/ ABORT". La schermata numerica visualizzerà .00000. Sensore di ventilazione per pressione atmosferica; premendo  sullo schermo apparirà la scritta "WAIT" e partirà un conto alla rovescia di 6 secondi dopo il quale apparirà per breve tempo la scritta CAL, quindi si andrà automaticamente al passo successivo.
7. Sullo schermo lampeggia la scritta "APPLY/ REF/ PSI/ THEN/ PRESS/ ENTER/ TO/ START/ OR/ OTHER/ TO/

ABORT”; applicare la scala completa di valori di pressione in unità di misura psi indicata sulla schermata numerica al manometro. Premendo  sullo schermo apparirà la scritta “WAIT” e partirà un conto alla rovescia di 6 secondi, dopo il quale apparirà per breve tempo la scritta CAL quindi si andrà automaticamente al passo successivo.











8. Sullo schermo lampeggia la scritta “APPLY/ REF/ PSI/ THEN/ PRESS/ ENTER/ TO/ START/ OR/ OTHER/ TO/ ABORT”; applicare la pressione indicata sulla schermata numerica al manometro e premere  sullo schermo apparirà la scritta “WAIT” e partirà un conto alla rovescia di 6 secondi, dopo il quale apparirà per breve tempo la scritta GOOD quindi si passa alla modalità Misurazione.

Nota: ritaratura è consentita soltanto se i parametri del test rientrano nella soglia del $\pm 7\%$. Fuori da questa finestra, sullo schermo apparirà la scritta “CAL FAIL / INPUT PRES TOO LOW (HIGH) / PRESS ENTER TO RETRY / PRESS OTHER TO ABORT”.













Nota: L’opzione “FIELD” apparirà soltanto se la taratura sul campo del manometro è avvenuta con successo.

Grafico:

Fornisce all’utente la possibilità di modificare i valori della pressione stabilendo le indicazioni di valore massimo/minimo lungo i 20 segmenti del grafico a barre.

1. In modalità Menu, premere , , , fino a quando apparirà la scritta “GRAPH”; premere .
2. Sullo schermo apparirà la scritta “CGOFF” (personalizzazione dei grafici disattivata) [default], “CG ON” (personalizzazione dei grafici attivata) o “NEWCG” (nuovo grafico personalizzato). Premere , ,  per scorrere.
3. Per richiamare l’ultima personalizzazione dei grafici immessa, quando appare la scritta “CG ON” premere . Sullo schermo apparirà per breve tempo la scritta “DONE” e si tornerà alla modalità Misurazione.
4. Per reimpostare il grafico a barre sulla scala completa, quando appare la scritta “CGOFF” premere . Sullo schermo apparirà per breve tempo la scritta “DONE” e si tornerà alla modalità Misurazione.
5. Per immettere un nuovo grafico a barre personalizzato, quando appare la scritta “NEWCG” premere .





6. Per programmare la percentuale minima del grafico, sullo schermo apparirà 0 0 wcon la cifra di destra lampeggiante, il segmento inferiore del grafico lampeggerà e sullo schermo apparirà la scritta "PCTFS" (scala completa in percentuale). Premere ,  ➔ per scorrere fino a un numero compreso fra 0 e 9. Premere  ➔ per selezionarlo. per scorrere fino a un numero compreso fra 0 e 9. Premere ,  ➔ scorrere fino a un numero compreso fra 0 e 9. Premere  ➔ per selezionarlo. Il numero a 2 cifre immesso rappresenta la percentuale della scala da utilizzare nella parte finale del grafico (0-99%).
7. Per programmare la percentuale massima della scala completa, sullo schermo apparirà 1 0 0 con la cifra di destra lampeggiante, il segmento superiore del grafico lampeggerà e sullo schermo apparirà la scritta PCTFS (scala completa in percentuale). Premere ,  ➔ per scorrere fino a un numero compreso fra 0 e 9. Premere  ➔ per selezionarlo. Le 2 cifre a sinistra inizieranno a lampeggiare Premere ,  ➔ per scorrere fino a un numero compreso fra 0 e 10. Premere  ➔ per selezionarlo. Il numero immesso rappresenta la percentuale della scala completa da utilizzare nella parte superiore del grafico. Nota: 100 è il più alto numero di 3 cifre e l'unico possibile. Se il numero inferiore è uguale o maggiore del numero superiore, sull'unità lampeggerà la scritta "REJCT" e si andrà al sub-menù "GRAPH".

Nota: Il messaggio "ULOCK" sullo schermo indica che sono in uso unità personalizzate e i grafici a barre minimo e massimo sono impostati sui valori di default.

Reimpostare:

Riporta il prodotto ai valori di default di fabbrica. Preserva la taratura sul campo. La taratura di fabbrica può essere ripristinata dal menù "RECAL".

In modalità Menu premere ,  ➔ fino a quando sulla riga inferiore dello schermo apparirà la scritta "RESET". Premere  ➔.

I valori di default di fabbrica riguardano le unità, il temporizzatore, la retroilluminazione, la velocità di aggiornamento, il blocco dell'azzeramento.

Sullo schermo apparirà la scritta "DONE" quindi il manometro passerà alla condizione "OFF".



6.0 SOSTITUZIONE DELLA BATTERIA

Il manometro è alimentato tramite due batterie alcaline tipo AA da 1.5 volt. Nella normale attività, le batterie dureranno approssimativamente 2000 ore prima di richiedere la sostituzione. La durata effettiva delle batterie dipende dall'uso del manometro, dalla temperatura ambientale e da altri fattori.

Sostituire le batterie procedendo come segue:

1. Far scorrere la custodia protettiva (non illustrata) fuori dall'alloggiamento del manometro.
2. Prendere la copertura posteriore zigrinata e ruotarla in senso antiorario fino a quando l'icona "unlock" è allineata con la freccia che si trova nell'alloggiamento alla base del raccordo di pressione (vedi figura A).
3. Rimuovere la copertura tirandola indietro in linea retta e sostituire opportunamente le batterie alcaline AA; assicurarsi che la posizione delle batterie rispetti la corretta polarità (vedi figura B).
4. Per reinserire la copertura, allineare l'icona "unlock" con la freccia, spingere in avanti la copertura e ruotare in senso orario fino a quando la freccia è allineata con l'icona "Lock" (vedi figura C).
5. Reinstallare la custodia protettiva (non illustrata) nell'alloggiamento del manometro.

Nota: Il reinserimento della copertura posteriore può causare la lettura di pressione negativa. Questo è un problema temporaneo, poiché la pressione interna dell'involucro verrà attenuata dalla ventilazione e si uniformerà alla pressione atmosferica (il 90% della differenza si uniformerà in 1 minuto, il rimanente 10% potrà impiegare fino a 5 minuti).

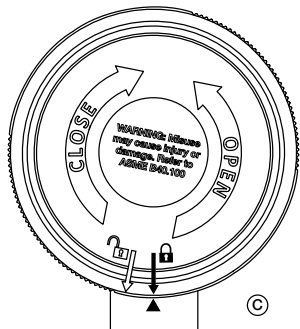
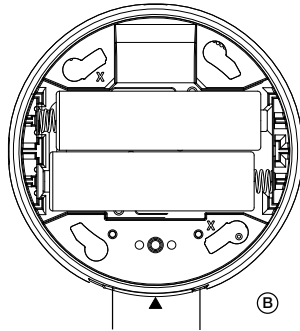
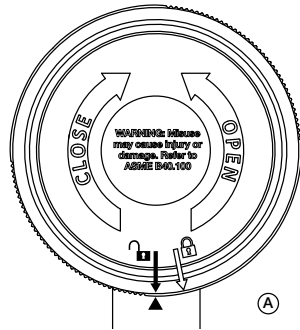

7.0 TECNICI - MODELLO DGR-2 MANOMETRO DIGITALE

Dimensioni:

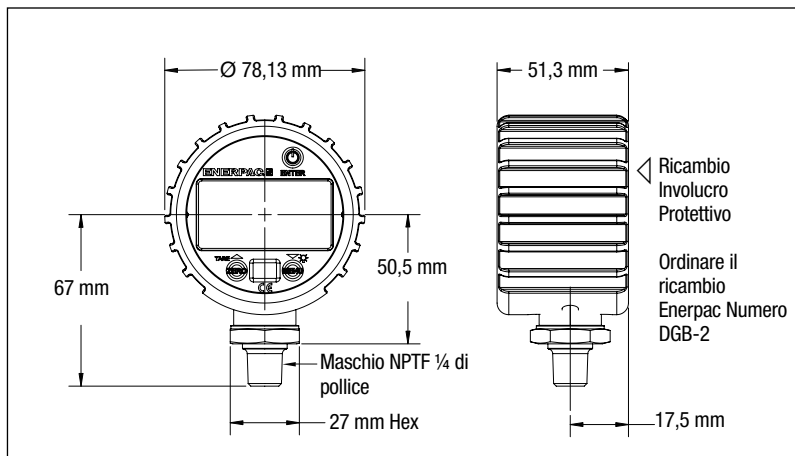

Specifiche:

Potenza massima della pressione				Precisione	Velocità di Aggiornamento	Energia richiesta	Peso		Giunto idraulico	Classificazione dell'involucro
psi	bar	mPa	kg/cm ²	0.25%	250ms 500ms 1s (selezionabile dall'utente)	3 volts a corrente continua (due batterie AA alcaline)	libbre	kg	Maschio NPTF ¼ di pollice	IP67
20000	1380	140	1400							
AVVERTENZA: Non superare mai la potenza massima della pressione										
		0.5	0,23							

Specifiche Ambientali	
	Gamma accettabile
Temperatura Ambientale di funzionamento	4°F a 140°F [-20°C a 60°C]
Temperatura dell'olio idraulico	4°F a 176°F [-20°C a 80°C]
Temperatura di immagazzinamento (batterie inserite)	4°F a 140°F [-20°C a 60°C]
Temperatura di immagazzinamento (batterie rimosse)	4°F a 176°F [-20°C a 80°C]
Coefficiente di temperatura	0.04%/°F [da -20°C a 180°C] zero e intervallo, temperatura di riferimento 70°F

Dati riguardanti la gamma e l'intervallo		
Unità di misura selezionata	Gamma	Intervallo
psi	0-20000	1
bar	0-1380	0.1
mPa	0-140	0.01
kg/cm ²	0-1400	0.1

Certificazioni di agenzie
CE EN 61326 (1998) CE EN 61326 Annex A (industria pesante) UL/cUL-61010-1 (in corso)

Questo dispositivo rispetta i requisiti previsti per il marchio CE.

L4009 Rev. A 01/13

1.0 IMPORTANTES INSTRUCCIONES DE RECEPCIÓN

Inspeccione visualmente todos los componentes para verificar si hay daños de envío. Debido a que la garantía no ampara daños por envío, si los hubiese, infórmeselo inmediatamente a la empresa de transportes, puesto que ésta es responsable de todos los gastos de reparaciones o reemplazo que resulten por daños de envío.

SEGURIDAD PRIMERO

2.0 ASPECTOS DE SEGURIDADÉ



Lea todas las instrucciones, advertencias y precauciones.

Acate todas las precauciones de seguridad para evitar lesiones personales o daños a la propiedad durante la operación del sistema. ENERPAC no puede ser responsable de daños o lesiones que resulten de no usar el producto de forma segura, falta de mantenimiento o aplicación incorrecta del producto y/u operación del sistema. Comuníquese con ENERPAC si tuviese dudas sobre las precauciones de seguridad o sobre las aplicaciones. Si nunca ha sido capacitado en seguridad hidráulica de alta presión, consulte a su distribuidor o centro de servicio para obtener un curso de seguridad gratis denominado ENERPAC Hydraulic.

El no cumplir con las siguientes precauciones y advertencias podría causar daños al equipo y lesiones personales.

Una **PRECAUCIÓN** se utiliza para indicar procedimientos y prácticas de operación o mantenimiento correctos para evitar daños o la destrucción de equipo u otra propiedad.

Una **ADVERTENCIA** indica un potencial peligro que requiere de procedimientos o prácticas correctos para evitar lesiones personales.

Un **PELIGRO** se utiliza sólo cuando su acción o falta de acción podría causar lesiones graves o incluso la muerte.



ADVERTENCIA: Use el equipo de protección personal adecuado cuando opere equipo hidráulico.



ADVERTENCIA: Manténgase alejado de las cargas soportadas por sistemas hidráulicos. Cuando un cilindro se utiliza como dispositivo para levantar carga, nunca debería usarse como dispositivo para sostener carga. Después de que la carga haya sido levantada o descendida, debe bloquearse siempre en forma mecánica.



ADVERTENCIA: USE SÓLO PIEZAS RÍGIDAS PARA SOSTENER CARGAS. Seleccione cuidadosamente bloques de acero o de madera capaces de soportar la carga. Nunca use un cilindro hidráulico como calza o separador en aplicaciones de levantamiento o presión.



PELIGRO: Para evitar lesiones personales, mantenga las manos y los pies alejados del cilindro y pieza de trabajo durante la operación.



ADVERTENCIA: No sobrepase el valor nominal del equipo. Nunca intente levantar una carga que pese más de la capacidad del cilindro. Las sobrecargas ocasionan fallas del equipo y posibles lesiones personales. Los cilindros están diseñados para resistir una presión máxima de 700 bar. No conecte un gato o cilindro a una bomba cuyo valor nominal de presión es mayor que el indicado.



Nunca fije la válvula de seguridad a una presión más alta que el máximo valor nominal de presión de la bomba. Los ajustes más altos pueden resultar en daños al equipo y/o lesiones personales.



ADVERTENCIA: La presión de operación del sistema no debe sobrepasar el valor nominal de presión del componente con el valor nominal más bajo en el sistema. Instale manómetros de presión en el sistema para vigilar la presión de operación. Es su ventana a lo que está sucediendo en el sistema.



PRECAUCIÓN: Evite dañar la manguera hidráulica. Evite pliegues y curvas agudos al guiar las mangueras hidráulicas. Usar una manguera con pliegues o curvas puede causar severa contrapresión. Los pliegues y curvas agudos causarán daños internos la manguera, lo que ocasionará que ésta falle prematuramente.



No deje caer objetos pesados sobre la manguera. Un impacto directo puede causar daños internos a las hebras de alambre de la manguera. Aplicar presión a una manguera dañada puede ocasionar que se quiebre.



IMPORTANTE: No levante el equipo hidráulico por las mangueras o acopladores giratorios. Use el mango de transporte u otros medios para transportarla con seguridad.



PRECAUCIÓN: Mantenga el equipo hidráulico alejado de las llamas y el calor. El calor en exceso ablandará las juntas y sellos, lo que resultará en fugas de líquidos. Asimismo, el calor debilita los materiales de la manguera y juntas. Para lograr un rendimiento óptimo, no exponga el equipo a temperaturas de 65 °C [150 °F] o mayores. Proteja las mangueras y cilindros de salpicaduras de soldadura.



PELIGRO: No manipule mangueras bajo presión. El aceite que escape bajo presión puede penetrar la piel y causar lesiones graves. Si se inyecta aceite bajo la piel, consulte a un médico inmediatamente.



ADVERTENCIA: Use cilindros hidráulicos únicamente en sistemas acoplados. Nunca use un cilindro si los acopladores no están conectados. Si el cilindro se sobrecarga, los componentes pueden fallar calamitosamente, lo que causaría lesiones personales graves.



ADVERTENCIA: Asegure que el equipo sea antes de levantar la carga. El cilindro debe colocarse sobre una superficie plana capaz de soportar la carga. De ser necesario, utilice una base de cilindro para mayor estabilidad. No suelde ni modifique el cilindro en modo alguno para fijarle una base u otro medio de soporte.



Evite las situaciones en las cuales las cargas no estén directamente centradas sobre el émbolo del cilindro. Las cargas descentradas producen un esfuerzo considerable sobre los cilindros y los émbolos. Además, la carga podría resbalar o caerse, creando situaciones potencialmente peligrosas.



Distribuya la carga uniformemente sobre la superficie total del asiento del cilindro. Siempre utilice un asiento para proteger el émbolo cuando no se usen accesorios roscados.



IMPORTANTE: Únicamente técnicos calificados en sistemas hidráulicos habrán de prestarle servicio al equipo hidráulico. Comuníquese con el Centro de Servicio ENERPAC autorizado en su zona para prestarle servicio de reparaciones. Use únicamente aceite ENERPAC a fin de proteger su garantía.



ADVERTENCIA: Reemplace inmediatamente las piezas gastadas o dañadas por piezas ENERPAC genuinas. Las piezas de clasificación estándar se romperán, lo que causará lesiones personales y daños a la propiedad. Las piezas ENERPAC están diseñadas para encajar debidamente y resistir altas cargas.

3.0 DESCRIPCIÓN

El manómetro digital Enerpac DGR-2 está diseñado para monitorizar presiones de sistema de hasta 20.000 psi [1.380 bar]. Entre sus características destacan:

- Indicadores en múltiples unidades: psi, bar, mPa y kg/cm² (configurable).
- La función de puesta a cero garantiza que el manómetro lee la presión real del sistema.
- Funciona con dos pilas 1,5 V AA (incluidas).
- Diseño de carcasa con calificación IP67.
- Temporizador de apagado del manómetro configurable.
- Cumple con CE y RoHS.

Nota: Consulte la Sección 7.0 de este manual para obtener las especificaciones del producto y las dimensiones de instalación detalladas.

4.0 INSTALACIÓN

IMPORTANTE: Para garantizar el correcto funcionamiento y ayudar a evitar fallos del manómetro, lea y comprenda las siguientes instrucciones y precauciones antes de instalar el manómetro.



ADVERTENCIA: Puede darse un fallo que resulte en daños personales y/o daño a la propiedad como consecuencia de exceso de sobrepresión, de vibración, de pulsación de presión, de temperatura del instrumento, corrosión de las piezas con presión u otro uso inadecuado. Consulte con Enerpac antes de instalar el manómetro si tiene otras preguntas o preocupaciones.

Sobrepresión:

Los picos de presión que sobrepasen la presión estipulada para el manómetro pueden ocasionar daños mecánicos y/o eléctricos irreversibles a los elementos de medición y de la presión y que contienen presión. Los excesos y las subidas repentinas de presión pueden destruir un transductor de presión y se deben evitar a toda costa. Debe instalarse un amortiguador de presión para eliminar los efectos dañinos de los picos. Los picos se dan cuando se detiene de repente un flujo de líquidos, como con las válvulas solenoides de cierre rápido. Las subidas repentinas se dan cuando se inicia de repente un flujo, como

cuando una bomba se activa a toda potencia o se abre una válvula con rapidez.



ADVERTENCIA: El manómetro está calificado para una presión máxima de 20.000 psi [1.380 bar]. No exceda esta calificación de presión máxima bajo ningún concepto.

Subidas de presión:

Las subidas son especialmente dañinas a los manómetros si la tubería está vacía originalmente. Para evitar las subidas de presión, las líneas de flujo deben permanecer llenas (si es posible), las bombas deben subir de presión poco a poco y las válvulas deben abrirse poco a poco también. Para evitar daños tanto de los picos como de las subidas, debe instalarse una cámara de equilibrio. Síntomas de los efectos dañinos de los picos y de las subidas:

- El manómetro digital muestra una desviación de cero muy alta en su estado inicial.
- El manómetro digital permanece constante a pesar de la presión.
- Se muestra en pantalla un código de error.

Temperaturas bajas:

La formación de hielo sobre el puerto de presión del manómetro puede provocar daños permanentes al manómetro. Siempre que sea posible, coloque el manómetro en posición vertical hacia arriba para ayudar a evitar los posibles daños de sobrepresión debidos a la congelación.

Nota: Inspeccione todo el sistema hidráulico para detectar fugas si sospecha que ha entrado agua en el sistema. Realice las reparaciones necesarias antes de volver a utilizar el sistema.

Requisitos de instalación:







Es necesaria una llave hexagonal de 27 mm [1-1/16 pulg.] para apretar el manómetro a la conexión hidráulica. Aplique cinta de Teflon o un compuesto sellante a las roscas NPTF de 1/4 pulg. del manómetro. Apriete con la llave una vuelta más del apretado manual o hasta que se consiga un sello antifugas.



⚠ PRECAUCIÓN: Apretar el manómetro agarrándolo o colocando una herramienta sobre la carcasa de plástico puede provocar daños permanentes al manómetro.

5.0 INSTRUCCIONES DE FUNCIONAMIENTO

Botones:

- ① Encendido-apagado / Intro 
- ② Cero / Flecha arriba / Tara  Tara
- ③ Selección de menú / Flecha abajo / Retroiluminación  
- ④ Pulsaciones **cortas**  menos de 0,5 segundos; **largas**  más de 0,5 segundos



Pantalla LCD y funciones:

- ① 5 dígitos para la indicación de presión.
- ② Gráfica de barra del rango de presión con 20 segmentos: cada segmento equivale al 5% del rango.
- ③ Símbolos del temporizador de retroiluminación y de suspensión.
- ④ Iconos de presión máxima / mínima y tara.
- ⑤ Indicador alfanumérico de 5 caracteres.
- ⑥ Indicador de la batería restante de 4 segmentos.
- ⑦ Indicador de presión negativa.

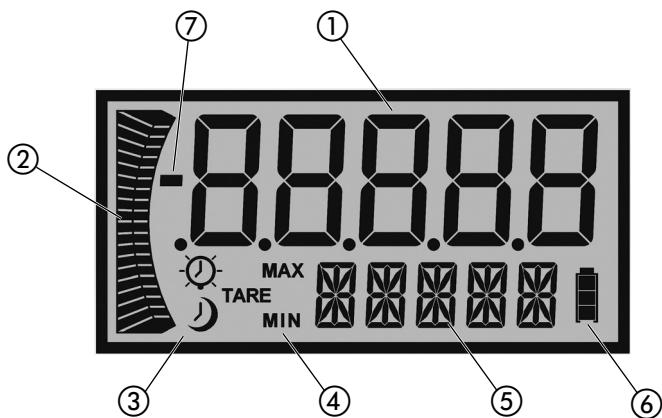

Nota: Las pulsaciones cortas (menos de 0,5 seg.) se indican con el ICONO "⏻".

Las pulsaciones largas (más de 0,5 seg.) se indican con el ICONO "⏻".

Encendido/apagado del manómetro

Pulse el botón  para encender/apagar el manómetro. Cuando se encienda, la pantalla mostrará por un momento todos los segmentos del LCD iluminados, la versión del producto y el rango de escala completa. A continuación, la unidad pasará automáticamente al modo Medición.

Función de cero:

Pulse . Al soltar el botón, el indicador numérico desaparece por un momento y se muestra "ZERO" en el indicador alfanumérico, antes de volver al modo Medición. La lectura de la presión ahora debería ser 0. Se almacena en memoria el valor de cero.



Nota 1: El mensaje en pantalla "RLOCK" indica que el cero es más de un $\pm 5\%$ de la calibración de fábrica. No se puede poner a cero.

Nota 2: El mensaje "ZLOCK" indica que se activado la función Bloqueo-0.



Función de tara:





Resta el valor actual de presión del valor mostrado en el modo Medición.

Resta el valor actual de presión del valor mostrado en el modo Medición **ZERO**  para habilitar la función de tara. En la pantalla parpadeará rápidamente "TARE" y, a continuación, se mostrará el icono "TARE" y parpadeará la lectura de presión. En la unidad debe leerse ahora 0. Pulse **ZERO**  para deshabilitar la función de tara. En la pantalla parpadeará rápidamente "T OFF" y, a continuación, el icono "TARE" desaparecerá y la lectura de presión dejará de parpadear. La unidad volverá al modo Medición.









Programación:

Para entrar al modo Menú

1. Pulse y suelte **menu**  para pasar al modo Programación.
2. Pulse , , para desplazarse por las opciones del menú programables.
3. Cuando se llegue a la opción que quiere, pulse  para acceder a ese parámetro.
4. Si en cualquier momento quiere SALIR del modo Menú (o del modo Submenú), mantenga pulsado **menu** . No se guardarán los cambios.

Parámetros programables:

Unidades de medida:



1. En el modo Menú, pulse , , para desplazarse a "UNITS", y, a continuación, pulse .
2. Seleccione las unidades de medida desplazándose por las opciones ,  , hasta que se muestre la unidad que quiere: "PSI, BAR, kg/cm, mPa o unidades personalizadas por el cliente (CUSTM)".
3. Pulse  para seleccionar las unidades y volver al modo Medición

Nota: Para la programación de unidades personalizadas, vea la página 72.





Unidades personalizadas de medida:

Permite al usuario definir una unidad personalizada de medida. El usuario debe introducir un valor de escala completa de la lectura que desea, lo que puede hacerse como sigue:



1. En el modo Menú, pulse ,  →, seleccione "CUSTM" y, a continuación, pulse  →.
2. Seleccione el lugar del símbolo de los decimales:



El indicador alfanumérico debe mostrar "SELDP".



La primera pantalla en aparecer mostrará todos los dígitos iluminados como "5" y parpadeará el símbolo del decimal más a la derecha (5 5 5 5.5), a no ser que se haya utilizado la función de unidades personalizadas. Si se ha utilizado, los dígitos y la posición del símbolo del decimal corresponderán a los últimos valores ajustados. Utilice los botones ,  → para desplazar el símbolo del decimal a la izquierda o a la derecha. Una vez el símbolo del decimal esté en la posición que quiere, pulse  → para fijarlo en su sitio. Cuando se suelta el botón, en la pantalla se lee "DIGIT".

3. Escoja el valor de escala completa:
El indicador alfanumérico mostrará "DIGIT".

La siguiente pantalla continuará mostrando todos los dígitos como "5", mientras el dígito más a la izquierda parpadea y el símbolo del decimal queda fijado en la posición escogida anteriormente. Sin embargo, si la función de unidades personalizadas se ha utilizado

previamente, los dígitos corresponden a su último valor. El símbolo del decimal permanece en el lugar escogido en el paso 1. Pulse ,  → para cambiar el valor del dígito entre 0 y 9.

Una vez se muestre el valor que quiere, pulse el botón  → para fijarlo en su sitio. Ahora el siguiente dígito a la derecha empezará a parpadear. Repita este procedimiento para los 5 dígitos. Cuando se pulsa y suelta  → mientras parpadea el quinto dígito, el manómetro mostrará brevemente "DONE". A continuación, volverá al modo Medición y mostrará "CUSTM", junto a lecturas numéricas que indican que la función está en uso.







Si así lo desea, en cualquier momento el usuario puede salir antes de pulsar el botón Intro con  →. Si el usuario sale del menú con  → antes de completar el paso 2 o sale del menú por desconexión por tiempo, se perderá todo lo que haya introducido.

Nota: La gráfica de barra utiliza el valor de ajuste predeterminado cuando se utilizan unidades personalizadas.

Nota: La magnitud del valor introducido cuando se utiliza la función de unidades personalizadas puede aumentar significativamente el ruido en la pantalla, lo que puede afectar las funciones de cero y de tara, además de la estabilidad de la lectura de presión mostrada. Si es necesario, consulte con la fábrica para conocer las limitaciones recomendadas con la entrada a escala completa.

Máximo / Mínimo:

Muestra los valores de presión máxima y mínima. Esta función se inicializa con el encendido de la unidad o desde que se borran los valores.







1. En el modo Menú, pulse ,  para desplazarse a "Max" (indicador de máximo). Esto se indica con un tipo de letra pequeño en la parte izquierda de la unidad de medida de la pantalla.
2. Para borrar ambos valores Mínimo y Máximo, mantenga pulsado  para borrar.
3. Cuando suelte este botón, saldrá al modo Menú. Utilice ,  para continuar desplazándose por las opciones de menú O BIEN mantenga pulsado  para volver al modo Medición.

Nota: Si borra los valores Mínimo / Máximo, la pantalla se quedará vacía a excepción del icono asociado Min. / Max. y el indicador de batería.

Nota: Las siguientes acciones también borrarán los valores Mínimo / Máximo: Apagado, función de manómetro a cero, función de tara, función de calibración de campo, programación de unidades, frecuencia de actualización o reinicio a valores predeterminados.

Temporizador:

Controla cuánto tiempo permanecerá encendido el manómetro una vez se pulse el botón .





1. En el modo Menú, pulse ,  para desplazarse hasta que se muestre "TIMER".
2. Pulse .
3. A continuación, pulse ,  para desplazarse por los valores. "NONE" indica que el manómetro permanecerá encendido hasta que el botón de encendido  se pulse una segunda vez. Cualquier otro valor (1 min [predeterminado] / 5 min / 20 min) que no sea "NONE" designará cuánto tiempo estará esta función activa.
4. Pulse  para seleccionar el valor que quiera, el icono del temporizador se mostrará en la pantalla y la unidad mostrará "DONE" y, a continuación, volverá al modo Medición.

Función: El icono del temporizador parpadeará 10 segundos antes de apagarse el manómetro. Mientras esté encendido el manómetro, cualquier pulsación de botón pondrá a cero el temporizador.



Luz:

Determina cuánto tiempo permanecerá la retroiluminación activa después de pulsar cualquier botón en los modos Medición o Menú (nota: el temporizador se pone a cero cuando se pulsa cualquier botón).

1. En el modo Menú, pulse ,  → hasta que se muestre "LIGHT".
2. Pulse  → para que aparezca el valor del temporizador. "ON" significa que la retroiluminación permanecerá activa mientras la unidad esté encendida, "PRESS" significa que la retroiluminación se activará / desactivará cuando se pulse brevemente  →; mientras que "OFF" indica que no se activará la retroiluminación nunca. Seleccionar los valores de tiempo, "1 MIN" (predeterminado), "5 MIN", "20 MIN" activará el símbolo de retroiluminación en la pantalla LCD durante los minutos indicados.
3. Pulse  → para seleccionar el tiempo de retroiluminación (se mostrará brevemente "DONE") y volver al modo Medición.







Nota: En el modo "PRESS", el ajuste predeterminado del temporizador es de una hora para ahorrar batería.

Función: El indicador de retroiluminación parpadeará durante 10 segundos antes de apagar la luz.



Actualización:

Se utiliza para seleccionar la frecuencia de actualización en pantalla del valor de presión mostrado. Esta función se utiliza cuando los cambios repentinos de presión provocan un "revoloteo" en los valores de la pantalla. Un intervalo más largo reducirá la frecuencia de actualización y "calculará un promedio" de las lecturas en tales aplicaciones.







1. En el modo Menú, pulse ,  → hasta que aparezca "UPDAT".
2. Pulse  → para seleccionar.
3. Pulse ,  → para seleccionar valores: "1 SEC" (predeterminado), "500 MSEC" o "250 MSEC".
4. Pulse  → para seleccionar un valor (se mostrará brevemente "DONE") y volver al modo Medición.

Nota: Cambiar a un valor que no sea 1 segundo puede provocar una ligera desviación de cero, con lo que se recomienda que el manómetro esté completamente descargado y puesto a cero antes de tomar lecturas precisas. Además, la vida de la batería se reducirá con el uso si la frecuencia de actualización es mayor a 1 SEC.



Bloqueo-0:

Se utiliza para evitar la puesta a cero no intencionada del manómetro.











1. En el modo Menú, pulse ,  → hasta que aparezca “ZLOCK”.
2. Pulse  → para seleccionar.
3. Pulse ,  → para seleccionar “L ON” o “L OFF” (predeterminado).
4. Pulse  → para seleccionar un valor (se mostrará brevemente “DONE”) y volver al modo Medición.



Nota: Si se activa el Bloqueo-0, el manómetro mostrará “ZLOCK” si se intenta la puesta a cero.





Recalibración:

Permite al usuario realizar una calibración de campo del producto. La calibración original de fábrica se guarda permanentemente en memoria y puede recuperarse en cualquier momento.

1. En el modo Menú, pulse ,  → hasta que aparezca “RECAL”. A continuación, pulse  →.
2. La pantalla indicará “FACT” (fábrica) “FIELD” o “NEW”. Pulse ,  → para desplazarse.
3. Si pulsa  → mientras se muestra “FACT” (fábrica), se recuperarán los valores de calibración de fábrica.
4. Si pulsa  → cuando se muestra “FIELD”, se recuperarán los valores de la última calibración de campo.
5. Si pulsa el botón “Intro”  → cuando aparezca “NEW”, se entrará en el modo Recalibración.
6. Cuando se muestre “NEW”, pulse  →. Al soltar el botón, la pantalla parpadeará: “OK/ APPLY/ REF/ PSI/ THEN/ PRESS/ ENTER/ TO/ START/ OR/ OTHER/ TO/ ABORT” (OK, APLIQUE PSI DE REFERENCIA Y, A CONTINUACIÓN, PULSE INTRO PARA COMENZAR U OTRO BOTÓN PARA ABORTAR). La pantalla numérica mostrará .00000. Descargue el sensor a la presión atmosférica, pulse  →, la pantalla mostrará “WAIT”, hará una cuenta atrás de 6 segundos, mostrará brevemente CAL y pasará automáticamente al siguiente paso.
7. La pantalla parpadea: “APPLY/ REF/ PSI/ THEN/ PRESS/ ENTER/ TO/ START/ OR/ OTHER/ TO/ ABORT” (APLIQUE PSI DE REFERENCIA Y, A CONTINUACIÓN,

PULSE INTRO PARA COMENZAR U OTRO BOTÓN PARA ABORTAR). Aplique la presión a escala completa en las unidades psi indicadas en el indicador numérico para medir. Pulse   display will show “WAIT” and count down from 6 seconds then briefly display CAL then automatically go to next step.















8. La pantalla parpadea: “APPLY/ REF/ PSI/ THEN/ PRESS/ ENTER/ TO/ START/ OR/ OTHER/ TO/ ABORT” (APLIQUE PSI DE REFERENCIA Y, A CONTINUACIÓN, PULSE INTRO PARA COMENZAR U OTRO BOTÓN PARA ABORTAR). Aplique la presión a escala completa en las unidades psi indicadas en el indicador numérico para medir y pulse  . La pantalla mostrará “WAIT”, hará una cuenta atrás de 6 segundos, mostrará brevemente GOOD y saldrá al modo Medición.

Nota: La recalibración solo se permite si los parámetros de prueba están dentro de $\pm 7\%$. Si está fuera de esta ventana, la pantalla indicará: “CAL FAIL / INPUT PRES TOO LOW (HIGH) / PRESS ENTER TO RETRY / PRESS OTHER TO ABORT” (FALLO DE CALIBRACIÓN, PRESIÓN DEMASIADO BAJA (ALTA), PULSE INTRO PARA REINTENTAR U OTRO BOTÓN PARA ABORTAR).







Nota: La opción “FIELD” aparece solo si el manómetro se ha recalibrado en campo satisfactoriamente.







Gráfica "GRAPH":

Permite al usuario modificar los valores de presión mediante la designación de indicaciones de mínimo / máximo en la gráfica de barra de 20 segmentos.

1. En el modo Menú, pulse ,  , hasta que aparezca “GRAPH”. A continuación, pulse  .
2. La pantalla indicará “CGOFF” (gráfica personalizada desactivada) [predeterminado], “CG ON” (gráfica personalizada activada) o “NEWCG” (nueva gráfica personalizada). Pulse ,   para desplazarse
3. Para recuperar la última gráfica introducida cuando se muestre “CG ON”, pulse  . La pantalla mostrará brevemente “DONE” y volverá al modo Medición.
4. Para poner a cero la gráfica de barra al rango de escala completa: cuando se muestre “CGOFF”, pulse  . La pantalla mostrará brevemente “DONE” y volverá al modo Medición.
5. Para introducir una nueva gráfica personalizada: cuando se muestre “NEWCG”, pulse  .





6. Para programar el porcentaje mínimo de la gráfica, la pantalla indicará 0 0 mientras el dígito de la derecha parpadea; el segmento inferior de la gráfica de barras parpadeará y en la pantalla se leerá "PCTFS" (escala completa de porcentaje). Pulse ,  para desplazarse a un número entre el 0 y el 9. Pulse  para seleccionar ese número. El dígito de la izquierda comenzará a parpadear. Pulse ,  para desplazarse a un número entre el 0 y el 9. Pulse  para seleccionar ese número. El número de 2 dígitos introducido representa el porcentaje de la escala completa que se utilizará como el extremo inferior de la gráfica (de 0 a 99%).

7. Para programar el porcentaje máximo de la escala completa, la pantalla indicará 1 0 0 y el dígito de la derecha parpadeará; el segmento superior de la gráfica parpadeará y en la pantalla se leerá PCTFS (escala completa de porcentaje). Pulse ,  para desplazarse a un número entre el 0 y el 9. Pulse  para seleccionar ese número. Los 2 dígitos de la izquierda comenzarán a parpadear. Pulse ,  para desplazarse a un número entre el 0 y el 10. Pulse  para seleccionar ese número. El número introducido representa el porcentaje de la escala completa que se utilizará como el extremo superior de la gráfica. Nota: 100 es el número más alto posible de 3 dígitos. Si el número inferior es igual o mayor que el número superior, en la unidad parpadeará "REJECT" y volverá al submenú "GRAPH".

Nota: El mensaje en pantalla "ULOCK" indica que las unidades personalizadas están en uso y que el mínimo y máximo de la barra están en sus valores predeterminados.

Puesta a cero:

Devuelve el producto a sus valores predeterminados de fábrica. Preserva la calibración de campo. La calibración de fábrica se puede restaurar en el menú "RECAL".

En el modo Menú pulse ,  para hasta que aparezca "RESET" en la línea inferior de la pantalla. Pulse .

Los valores predeterminados corresponden a unidades, temporizador, retroiluminación, frecuencia de actualización y bloqueo de puesta a cero.

La pantalla indicará "DONE" y, a continuación, el manómetro pasará al estado "OFF".



6.0 CAMBIO DE LAS PILAS

El manómetro funciona con dos pilas alcalinas de 1,5 voltios y de tipo AA. En servicio normal, las pilas duran aproximadamente 2.000 horas antes de que haga falta cambiarlas. La vida real de las pilas variará según el uso del manómetro, la temperatura ambiente y otros factores.

Cambie las pilas como se describe en los siguientes pasos:

1. Deslice la cubierta protectora (no mostrada) de la carcasa del manómetro.
2. Apriete la tapa posterior estriada y gírela en sentido antihorario hasta que el icono de desbloqueo esté alineado con la flecha, que se encuentra en la carcasa, en la base de la conexión de presión (véase la vista A).
3. Retire la tapa tirando de ella en línea recta y cambie las pilas alcalinas AA. Asegúrese de que coloca las pilas en la posición de polaridad adecuada (véase la vista B).
4. Para volver a colocar la tapa, alinee el icono de desbloqueo con la flecha, empuje la tapa en línea recta y gírela en sentido horario hasta que la flecha quede alineada con el icono de bloqueo (véase la vista C).
5. Vuelva a colocar la cubierta protectora (no mostrado) en la carcasa del manómetro.

Nota: La recolocación de la tapa trasera puede provocar que el manómetro lea una presión negativa. Esto es un problema temporal hasta que la presión interna de la carcasa se libera con el descargado de la carcasa y se iguala con la presión atmosférica (el 90% de la desviación se igualará en menos de 1 minuto y el 10% restante puede llevar hasta 5 minutos).

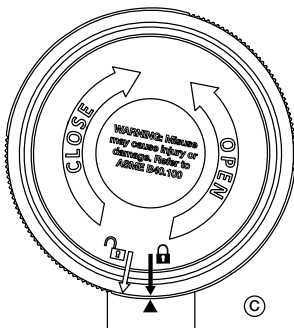
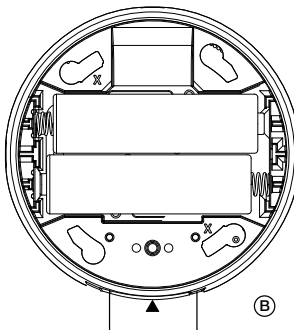
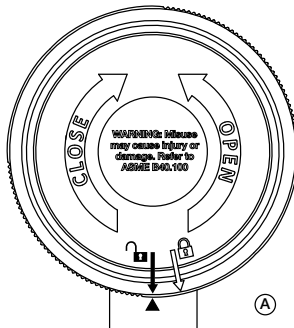

7.0 DATOS TÉCNICOS: MANÓMETRO DIGITAL DE PRESIÓN MODELO DGR-2

Dimensiones:

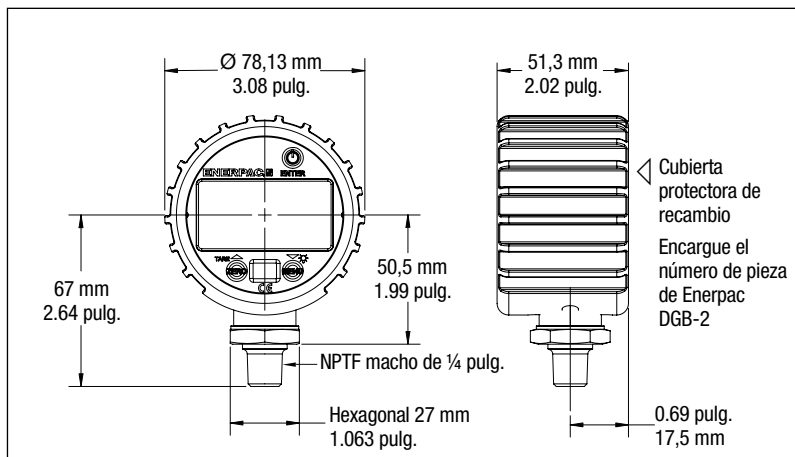

Especificaciones:

Calificación de presión máxima:				Precisión	Frecuencia de actualización	Requisitos de alimentación	Peso		Conexiones hidráulicas	Calificación de la caja
psi	bar	mPa	kg/cm ²				lbs	kg		
20000	1380	140	1400	0.25%	250ms 500ms 1s (configurable)	3 voltios CC (dos pilas alcalinas AA)	0.5	0.23	NPTF macho de 1/4 pulg.	IP67
⚠ ADVERTENCIA: No exceda la calificación de presión máxima bajo ningún concepto.										

Especificaciones medioambientales	
	Rango aceptable
Temperatura ambiente de funcionamiento	-20°C a 60°C [4°F a 140°F]
Temperatura del aceite hidráulico	-20°C a 80°C [4°F a 176°F]
Temperatura de almacenamiento (con pilas)	-20°C a 60°C [4°F a 140°F]
Temperatura de almacenamiento (sin pilas)	-20°C a 80°C [4°F a 176°F]
Coefficiente de temperatura	-20°C to 180°C [0.04%/°F] cero y lapso, temperatura de referencia 21° C [70 °F]

Información de rango y de intervalo		
Unidad de medida seleccionada	Rango	Intervalo
psi	0-20000	1
bar	0-1380	0.1
mPa	0-140	0.01
kg/cm ²	0-1400	0.1

Autorizaciones de agencias
CE EN 61326 (1998)
CE EN 61326 Anexo A (industria pesada)
UL/cUL-61010-1 (pendiente)
Conforme con RoHS

CE Este dispositivo cumple con los requisitos de marcado CE.

L4009 Rev. A 01/13

1.0 BELANGRIJKE INSTRUCTIES BIJ ONTVANGST

Controleer visueel alle onderdelen op schade opgelopen tijdens de verzending. Schade opgelopen tijdens de verzending wordt niet door de garantie gedekt. Als schade opgelopen tijdens de verzending wordt gevonden, de transporteur hier onmiddellijk van op de hoogte stellen. De transporteur is verantwoordelijk voor alle reparatie- of vervangingskosten als gevolg van opgelopen schade tijdens de verzending.

VEILIGHEID VOOROP

2.0 VEILIGHEIDSKWESTIES



Lees nauwkeurig alle instructies, waarschuwingen en let op-gedeelten. Volg

alle veiligheidsvoorzieningen om persoonlijk letsel of schade aan eigendom te voorkomen als het systeem in werking is. Enerpac kan niet verantwoordelijk worden gesteld voor schade of letsels als gevolg van onveilig gebruik van dit product, gebrek aan onderhoud, of onjuiste toepassing van het product of het systeem. Neem contact op met Enerpac mocht u twijfels hebben over veiligheidsvoorzieningen en werkingen. Als u nooit een opleiding in hogedruk hydraulische veiligheid hebt gevolgd neem dan contact om met uw verdeel- of servicecentrum voor een gratis veiligheids cursus van Enerpac Hydraulic.

Het niet volgen van deze waarschuwing sboodschappen en voorzorgsmaatregelen kan schade aan de machine en persoonlijk letsel veroorzaken.

LET OP wordt gebruikt om correcte bedienings- en onderhoudsprocedures en praktijken aan te duiden om schade aan, of vernietiging van, machines of andere eigendom te voorkomen.

WAARSCHUWING wijst op een mogelijk gevaar dat de juiste procedures en praktijken vereist om persoonlijk letsel te voorkomen.

GEVAAR wordt enkel gebruikt als uw actie of gebrek aan actie ernstig letsel of zelfs de dood tot gevolg kan hebben.



WAARSCHUWING: Draag de juiste persoonlijke beschermende kleding bij het werken met hydraulische machines.



WAARSCHUWING: Blijf uit de buurt van ladingen die hydraulisch worden ondersteund. Een cilinder die wordt gebruikt als een hefinrichting mag nooit worden gebruikt als een lasthouder. Nadat de lading omhoog of omlaag is gebracht, moet deze altijd mechanisch worden geblokkeerd.



WAARSCHUWING: GEBRUIK ENKEL STIJVE MATERIALEN OM DE LADINGEN VAST TE HOUDEN. Kies met zorg stalen of houten blokken die een lading kunnen ondersteunen. Gebruik nooit een hydraulische cilinder als een pakkingschijf of een afstandstuk in enige toepassing waarbij opheffen of drukken wordt gebruikt.



GEVAAR: Om persoonlijk letsel te voorkomen, handen en voeten weghouden van de cilinder en het werkstuk tijdens de bediening.



WAARSCHUWING: Niet de nominale waarden van de machines overschrijden. Probeer nooit om een lading op te heffen die meer weegt dan de capaciteit van de cilinder. Overladen veroorzaakt falen van de machine en mogelijk persoonlijk letsel. De cilinders zijn ontworpen voor een maximale druk van 700 bar. Geen vijzel of cilinder op een pomp aansluiten die een hogere drukwaarde heeft.



Nooit de ontlastklep instellen op een hogere druk dan de maximaal nominale druk van de pomp. Hogere instellingen kunnen schade aan de machine en/of persoonlijk letsel tot gevolg hebben.



WAARSCHUWING: De bedieningsdruk van het systeem mag de nominale drukwaarde van het onderdeel met de laagste waarde in het systeem niet overschrijden. Installeer drukmeters in het systeem om de bedieningsdruk te controleren. Op die manier weet u wat er in het systeem gebeurt.



LET OP: De hydraulische slang niet beschadigen. Vermijd ombuigen en knikken bij het aanbrengen van de hydraulische slangen. Een gebogen of geknikte slang gebruiken kan ernstige tegendruk van de afvoerstroomb veroorzaken. Scherpe ombuigingen en knikken beschadigen de slang aan de binnenkant wat tot vroegtijdig falen van de slang kan leiden.



Geen zware objecten op de slang laten vallen. Een scherpe impact kan interne schade aan de draadvezels van de slang veroorzaken. Druk uitoefenen op een slang die beschadigd is, kan scheuren van de slang tot gevolg hebben.



BELANGRIJK: Hydraulische machines niet bij de slangen of de wartelkoppelingen opheffen. Gebruik de draaghandgreep of een ander middel om de machine veilig te transporteren.



LET OP: Houd de hydraulische machine weg van vlammen en hitte. Buitenmatige hitte verzacht de pakkingen en afdichtingen wat tot vloeistoflekken kan leiden. Hitte verzwakt ook slangmaterialen en pakkingen. Voor optimale prestaties de machines niet blootstellen aan temperaturen van 65°C (150°F) of hoger. Bescherm slangen en cilinders tegen lasspetters.



GEVAAR: Slangen die onder druk staan, niet aanraken. Als olie die onder druk staat ontsnapt, kan het door de huid dringen wat ernstige letsel kan veroorzaken. Als olie onder de huid wordt geïnjecteerd, onmiddellijk een arts raadplegen.



WAARSCHUWING: Gebruik hydraulische cilinders enkel in een aangesloten systeem. Nooit een cilinder gebruiken met koppelingen die niet aangesloten zijn. Als de cilinder uiterst overladen is, kunnen onderdelen op een catastrofische manier falen wat ernstig persoonlijk letsel kan veroorzaken.



WAARSCHUWING: Zorg dat de apparatuur stabiel is opgezet alvorens lasten te heffen. De cilinder dient op een vlakke ondergrond geplaatst te worden die de last kan dragen. Gebruik waar mogelijk een ondersteuning voor de cilinder voor extra stabiliteit. De cilinder mag niet gelast of op een andere manier aangepast worden voor het bevestigen van een voetstuk of andere ondersteuning.



Vermijd situaties, waarbij de last niet aangrijpt in het hart van de cilinderplunjer. Niet-centrisch aangrijpende lasten veroorzaken aanzienlijke spanningen in de cilinder en de plunjer. Bovendien kan de last wegglijden of vallen, wat tot gevaarlijke situaties leidt.



Verdeel de last gelijkmatig over het gehele zadeloppervlak. Gebruik altijd een zadel om de plunjer te beschermen, wanneer geen hulpstukken met schroefdraad worden gebruikt.



BELANGRIJK: Hydraulische machines mogen enkel door een bevoegd hydraulisch technicus van onderhoud worden voorzien. Voor reparaties dient u contact op te nemen met een nabijgelegen bevoegd ENERPAC servicecentrum. Om uw garantie te beschermen, enkel ENERPAC olie gebruiken.



WAARSCHUWING: Versleten of beschadigde onderdelen onmiddellijk met authentieke ENERPAC onderdelen vervangen. Standaardonderdelen breken, wat tot persoonlijk letsel en schade aan eigendom kan leiden. ENERPAC onderdelen zijn zodanig ontworpen dat ze precies passen en hoge ladingen kunnen weerstaan.

3.0 BESCHRIJVING

De digitale manometer DGR-2 van Enerpac werd ontworpen voor het meten van systeemdrukken tot 1.379 bar [20.000 psi]. De standaardfuncties omvatten:

- Uitlezingen beschikbaar in verscheidene eenheden: psi, bar, mPa en kg/cm² (door de gebruiker te selecteren).
- Een nulstelfunctie borgt dat de meter de actuele systeemdruk uitleest.
- Voeding door middel van twee 1,5 V-batterijen, model AA (meegeleverd).
- Behuizing ontworpen voor klasse IP67.
- Door de gebruiker instelbare manometer-uitschakeltijd klok.
- In overeenstemming met CE en met RoHS

Opmerking: Raadpleeg paragraaf 7.0 van dit handboek voor gedetailleerde productspecificaties en inbouwmaten.

4.0 INFORMATIE BETREFFENDE HET INSTALLEREN

BELANGRIJK: Lees en begrijp onderstaande instructies en tref de nodige voorzorgsmaatregelen alvorens de manometer te gaan installeren, dit om een goede werking te borgen en om storingen in de meter te helpen voorkomen.



WAARSCHUWING: Een storing, die leidt tot persoonlijk letsel en/of tot schade aan eigendommen kan worden veroorzaakt door een buitensporige overdruk, bovenmatige trillingen en drukpulsen, een te hoge temperatuur van het instrument, corrosie van de drukvoerende onderdelen of andere vormen van misbruik. Vraag - als u vragen mocht hebben of problemen mocht ervaren - advies bij Enerpac alvorens u de manometer gaat installeren

Te hoge druk:

Drukpieken die hoger zijn dan de nominale druk van de manometer kunnen onomkeerbare elektrische en/of mechanische schade toebrengen aan drukmetende elementen en behuizingen. Vloeistofslag en snel in kracht wisselende vloeistofstromingen kunnen de drukopnemer vernielen. Tracht altijd deze effecten te voorkomen. Monteer een

drukreductor om de effecten van vloeistofslag te smoren. Vloeistofslag ontstaat als de stroming van een vloeistof plotseling wordt onderbroken, bijvoorbeeld door gebruik van snelsluitende magneetspoelkleppen. Schommelingen in de vloeistofstroming treden op als een pomp meteen op vol vermogen wordt ingeschakeld of als een klep snel wordt geopend.



WAARSCHUWING: De manometer heeft een nominale, maximale meetdruk van 1379 bar [20.000 psi]. Overschrijd nimmer deze nominale, maximumdruk.

Drukschommelingen:

Drukschommelingen zijn in het bijzonder schadelijk voor manometers als de meetpijp aanvankelijk leeg is. Laat (zo mogelijk) de vloeistofleidingen gevuld om drukschommelingen te voorkomen. Breng pompen langzaam op capaciteit. Open kleppen langzaam. Monteer een drukkamer om drukstoten op te vangen om zodoende zowel schade door vloeistofslag als door drukstoten te voorkomen. De schadetoebrengende symptomen als gevolg van vloeistofslag en drukstoten zijn:

- De digitale manometer vertoont een grote nulpuntverschuiving.
- De uitlezing van de digitale manometer blijft een constante waarde tonen ongeacht de grootte van de druk.
- Het scherm toont een storingmeldcode.

Lage temperaturen:

IJsvorming in de poort van de manometer kan permanente schade aan de manometer toebrengen. Monteer zo mogelijk de manometer in een verticale, staande positie om eventuele overdrukschade als gevolg van bevrozing te helpen voorkomen.

Opmerking: Inspecteer het volledige hydraulische systeem op lekkage als u vermoedt dat water is binnengedrongen in het meetsysteem. Voer de nodige reparaties uit alvorens het systeem weer in bedrijf te stellen.

Eisen, te stellen aan de installatie:

Gebruik een 27 mm-steeksleutel [1-1/16"] om de manometer op het hydraulische koppelstuk vast te zetten. Breng teflonlint of een

geschikt afdichtmiddel aan op de 1/4"-NPTF-schroefdraad van de manometer. Gebruik een sleutel, draai het koppelstuk één slag meer dan handvast aan totdat u een lekdichte afsluiting hebt verkregen.



WAARSCHUWING: Het vastzetten van de manometer door met een stuk gereedschap de behuizing van kunststof vast te grijpen of vast te klemmen kan de manometer blijvend beschadigen.

5.0 INSTRUCTIES VOOR HET BEDIENEN

Toetsenblok:

- ① Voeding Aan-Uit / Enter 
- ② Nul / Pijl Omhoog / Tarra  ▲ Tarra
- ③ Menukeuze / Pijl Omlaag / Achterverlichting 
 ▲ 
- ④ Toetsindrukken moet **kort** duren \Rightarrow korter dan 0,5 seconde, of **lang** duren: \dashrightarrow langer dan 0,5 seconde.



LCD-scherm en functies:

- ① Drukuitlezing via vijf numerieke cijfers.
- ② Staafgrafiek voor weergave van de druk in 20 segmenten: elk segment stelt 5% van het meetbereik voor.
- ③ Pictogrammen voor sluimermodus en de tijdklok van de achterverlichting.
- ④ Pictogrammen voor maximale en minimale druk en verschildruk.
- ⑤ Uitleesvenster met vijf alfanumerieke karakters.
- ⑥ Vier segmenten ter indicatie van de batterijcapaciteit.
- ⑦ Negatieve drukindicator.

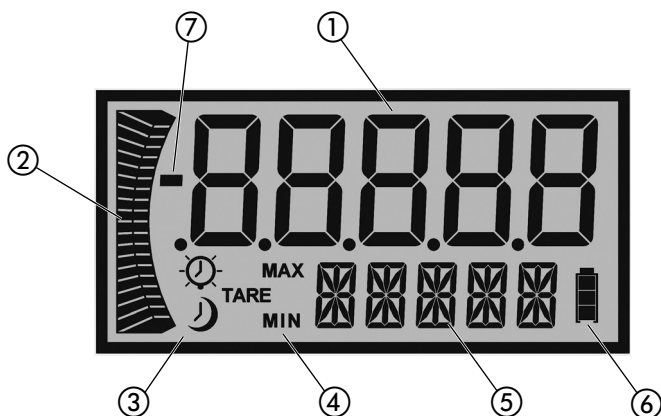

Opmerking: Kortstondige toetsindrukken (korter dan 0,5 s) worden aangeduid met de icoon "⏏"

Langduriger toetsindrukken (langer dan 0,5 s) worden aangeduid met de icoon "⏏→"

AAN/UIT-zetten van de manometer

Druk lang op de toets  → om manometer AAN of UIT te schakelen. Direct na het inschakelen zal het scherm kortstondig alle LCD-segmenten tonen, het versienummer van het product en het volledige schaalbereik. De meter gaat daarna automatisch over naar de meetmodus.



Nulstelfunctie:

Druk lang op de toets:  → . Na het loslaten van de toets zal de numerieke uitlezing kortstondig doven en 'ZERO' laten zien in het alfanumerieke deel van het scherm. Daarna keert de uitlezing terug naar de meetmodus. De drukwaarde moet nu 0 zijn. Deze nulwaarde wordt in het geheugen opgeslagen.

Opmerking 1: Een melding 'RLOCK' wijst erop dat de nulwaarde meer dan $\pm 5\%$ afwijkt van de in de fabriek geijkte waarde. Nulstellen is niet mogelijk.

Opmerking 2: Een melding 'ZLOCK' wijst erop dat de functie, die het nulstellen vergrendelt, werd geactiveerd.

Drukverschilfunctie (tarra):

Trekt de grootheid van de actuele drukwaarde af van de grootheid, die in meetmodus werd uitgelezen.

Leg in meetmodus de gewenste druk aan en druk kort op **ZERO** \rightarrow om de verschilwaarde uit te lezen. De uitlezing knippert snel 'TARE', en vervolgens verschijnt de icoon 'TARE'; de uitlezing van de drukwaarde knippert nu. De meter moet nu de waarde '0' aangeven. Druk weer kort op **ZERO** \rightarrow om de verschilfunctie te deactiveren. De uitlezing knippert snel 'T OFF', waarna de icoon 'TARE' verdwijnt en de drukuitlezing niet langer zal knipperen. De meter keert nu terug naar de meetmodus.



Programmering:

Oproepen van de menumodus

1. Druk lang op **menu** \rightarrow om de programmeermodus op te roepen.
2. Druk lang op **▲**, **▼** \rightarrow , om door de keuzes van het programmeermenu te bladeren.
3. Druk lang op **⏻** \rightarrow als u de gewenste keuze hebt gevonden en u de desbetreffende parameter wilt oproepen.
4. Wilt u op enig moment de menumodus (of de submenuodus) verlaten? Druk dan lang op **menu** \rightarrow . Uw wijzigingen worden nu niet opgeslagen.

Programmeerbare parameters:

Eenheden:



1. Druk in de menumodus kort op **▲**, **▼** \rightarrow , om naar de 'UNITS' te bladeren. Druk vervolgens kort op **⏻** \rightarrow .
2. Kies de gewenste eenheden door met **▲**, **▼** \rightarrow , te bladeren totdat de gewenste eenheid op het scherm verschijnt, 'PSI', 'BAR', 'kg/cm', 'mPa', of door u als klant gespecificeerde eenheid ('CUSTM').
3. Druk kort op **⏻** \rightarrow om de eenheid te selecteren en terug te keren naar de meetmodus.

Opmerking: Zie blz. 88 voor het klantspecifiek programmeren van eenheden.



Klantspecifieke eenheden:

Stelt een gebruiker in staat een klantspecifieke eenheid te definiëren. U moet als gebruiker de grootheid van de "volle schaaluitslag" op de uitlezing invoeren. Handel daartoe als volgt.

1. Druk in menumodus kort op ,  \rightarrow , selecteer 'CUSTM', druk vervolgens kort op  \rightarrow .
2. Selecteer de positie van het decimaalteken:

De alfanumerieke uitlezing toont nu 'SELDP'



Het eerstverschijnende scherm toont alle cijfers als '5', waarbij het meest rechtse decimaalteken knippert (5 5 5 5.5) tenzij u de functie "klantspecifieke eenheid" eerder al eens hebt gebruikt. Bij eerder gebruik zullen de cijfers en de plaats van het decimaalteken overeenkomen met de laatst door u ingestelde grootheden. Druk kort op ,  \rightarrow om het decimaalteken naar links of naar rechts te verplaatsen. Staat het decimaalteken op de door u gewenste positie? Druk dan kort op  \rightarrow om het decimaalteken op die positie te vergrendelen. Nadat u de toets hebt losgelaten toont het scherm 'DIGIT'.

3. Kies de "volle schaal"-waarde:

De alfanumerieke uitlezing toont nu 'DIGIT'

Het volgende scherm blijft alle cijfers als '5' tonen, waarbij het meest linkse cijfer knippert en het decimaalteken in de eerder gekozen positie vaststaat. Als u echter de functie "klantspecifieke eenheid" eerder hebt gebruikt, dan komen de cijfers overeen met de laatst getoonde waarde. Het decimaalteken blijft op de plaats die bij handeling 1 hebt

gekozen. Druk kort op ,  \rightarrow om het cijfer in te stellen op een waarde tussen 0 en 9.

Als eenmaal de gewenste waarde wordt getoond, drukt u kort op  \rightarrow om die te vergrendelen. Nu zal het cijfer rechts ervan gaan knipperen. Herhaal deze procedure voor alle vijf cijfers. Als u  \rightarrow indrukt en loslaat zal het vijfde cijfer gaan knipperen. De manometer toont kortstondig 'DONE', keert terug naar de meetmodus en toont 'CUSTM' samen met de numerieke uitlezing om aan te geven dat de functie in gebruik is.







U kunt op elk moment - voordat u de toets [Enter] hebt ingedrukt - het instelproces verlaten door lang te drukken op  \rightarrow . Als u het menu verlaat door lang op a  \rightarrow te drukken voordat handeling 2 is voltooid of als de gestelde tijdsduur voor een menu is verstreken, dan zullen alle door u ingevoerde gegevens verloren gaan.

Opmerking: De staafgrafiek past de in de fabriek gemaakte verstekinstellingen toe als klantspecifieke eenheden worden gebruikt.

Opmerking: De ingevoerde grootheid bij toepassing van de functie "klantspecifieke eenheden" kan de ruis op de uitlezing aanzien vergroten. Dit kan invloed hebben op de nulstelfunctie en op de verschilfuncties, evenals op de stabiliteit van de getoonde drukuitleiding. Vraag zo nodig de fabriek om advies voor aanbevelingen ten aanzien van de "volle schaal"-waarde.

Maximum / Minimum:

Toont de maximum- en minimumwaarden van de druk. Dit wordt geïnitieerd op het moment van het inschakelen van de meter of na het wissen van de waarden.

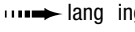







1. Druk in menumodus kort op ,  om naar 'Max' (maximale waarde-uitlezing) te bladeren. Dit wordt in een klein lettertype aangegeven en wel links van de eenheid.
2. Om *zowel* de minimumwaarde als de maximumwaarde te wissen drukt u lang op  .
3. Nadat u deze toets hebt losgelaten keert de meter terug naar de menumodus. Druk kort op ,  om door de menukeuzes te bladeren OF houd   lang ingedrukt om naar de meetmodus terug te keren.

Opmerking: Het wissen van minimumwaarde en maximumwaarde resulteert in een leeg scherm, afgezien van het pictogram Min/Max en de batterij-indicator.

Opmerking: Onderstaande handelingen wissen eveneens de minimumwaarde en de maximumwaarde. Voeding-uit, nulstelfunctie van de meter, verschilfunctie ('tarra'), de veldkalibreerfunctie, programmeren van eenheden, het ververstempo en de terugstelfunctie.

Tijd klok:

Regelt hoelang de voeding voor de manometer ingeschakeld blijft nadat u de aan/uit-toets  hebt ingedrukt.

1. Druk in menumodus kort op ,  om te bladeren totdat 'TIMER' verschijnt.
2. Druk kort op  .
3. Druk daarna kort op ,  om door de waarden te bladeren. "NONE" wijst erop dat de manometer ingeschakeld blijft totdat u voor de tweede keer op de aan/uit-toets  drukt. Elke andere waarde (1 min [verstekwaarde] / 5 min / 20 min), anders dan 'NONE' duidt erop dat de duurtijd van deze functie is geactiveerd.
4. Druk op  om de gewenste waarde te kiezen. De icoon 'tijd klok' verschijnt op het scherm en de meter toont 'DONE' voordat de meter terugkeert naar de meetmodus

Kenmerk: De icoon 'tijd klok' knippert gedurende 10 seconden voordat de manometer uitschakelt. Bij het inschakelen van de manometer zal met elke druk op een toets de tijd klok op nul worden gesteld.



Verlichting:

Bepaalt hoelang - na het indrukken van een toets in meetmodus of menumodus - de achterverlichting blijft ingeschakeld (opmerking: de tijd klok gaat opnieuw aftellen zodra u een toets indrukt.)

1. Druk in de menumodus kort op   totdat 'LIGHT' verschijnt.
2. Druk kort op  om de waarde van tijd klok te tonen. 'ON' wijst erop dat de achterverlichting altijd ingeschakeld blijft als de voeding is ingeschakeld, 'PRESS' wijst erop dat de achterverlichting is aan/uit-geschakeld door kort op de achterverlichtingstoets  te drukken, terwijl 'OFF' erop wijst dat de achterverlichting nimmer zal oplichten. De keuze van de tijds waarden "1 MIN" (verstekwaarde), "5 MIN", "20 MIN" zal de achterverlichting van het LCD-scherm gedurende het ingestelde aantal minuten laten oplichten.
3. Druk kort op  om de duurtijd van de achterverlichting te kiezen (het scherm toont kort 'DONE' en de meter keert daarna terug naar de meetmodus.

Opmerking: In de 'PRESS'-modus heeft de fabriek de tijd klok ingesteld op 1 uur om batterijcapaciteit te sparen.

Kenmerk: De indicator van de achterverlichting knippert 10 seconden lang voordat de achterverlichting uitschakelt.



Verversen:

Wordt gebruikt om het tempo in te stellen waarmee de getoonde drukwaarde op het scherm wordt verversd. Deze functie wordt gebruikt als snelle drukschommelingen resulteren in knipperende uitleeswaarden; langere tussenpozen verkleinen de snelheid van verversen en 'middelen' de uitlezing onder dergelijke meetcondities.







1. Druk in menumodus kort op   totdat 'UPDAT' verschijnt.
2. Druk kort op  om een keuze te maken.
3. Druk kort op   om waarden te selecteren als "1 SEC" (verstekwaarde), "500 MSEC", of "250 MSEC".
4. Druk kort op  om een waarde te selecteren (het scherm toont kortstondig 'DONE') en keert daarna terug naar de meetmodus.

Opmerking: Het wijzigen van de waarde tot enige waarde anders dan 1 s kan leiden tot een lichte nulpuntverschuiving. Wij adviseren u de manometer volledig te laten afblazen en opnieuw op nul te stellen alvorens u nauwkeurige metingen gaat uitvoeren. Voorts zal bij een ververs tempo van vaker dan eens per seconde de batterijcapaciteit snel afnemen.



Z-grendel:

Wordt gebruikt om te voorkomen dat per abuis de manometer weer op nul wordt gesteld.

1. Druk in menumodus kort op ,  totdat 'ZLOCK' verschijnt.
2. Druk kort op  om te selecteren.
3. Druk kort op ,  om "L ON" of "L OFF" (verstekinstelling) te selecteren.
4. Druk kort op  om de waarde te selecteren (het scherm toont kortstondig 'DONE') en de meter keert terug naar de meetmodus.

Opmerking: Als de Z-grendel is geactiveerd toont het scherm 'ZLOCK' als u probeert de meter op nul te stellen.



Herkalibreren:

Stelt u in staat in het veld het product te kalibreren. De originele ijking in de fabriek is permanent in het geheugen opgeslagen. U kunt de ijkwaarden op elk gewenst moment terugroepen.

1. Druk in menumodus kort op ,  totdat 'RECAL' verschijnt, druk daarna kort op .
2. Het scherm toont 'FACT' (fabrieksinstelling) "FIELD" of "NEW". Druk kort op ,  om te bladeren.
3. Door  in te drukken als 'FACT' (fabrieksinstelling) wordt getoond zal de waarden laten terugstellen naar de oorspronkelijke fabrieks-ijkwaarden.
4. Door  in te drukken als 'FIELD' wordt getoond zal worden teruggesteld naar de waarden van de laatste kalibratie in het veld.
5. Door op de [Enter]-toets  te drukken als 'NEW' wordt getoond, zal de herkalibreermodus worden opgeroepen.
6. Druk - als 'NEW' wordt getoond - kort op ; na het loslaten van de toets knippert het scherm OK/ APPLY/ REF/ PSI/ THEN/ PRESS/ ENTER/ TO/ START/ OR/ OTHER/ TO/ ABORT. De numerieke uitlezing toont .00000. Blaas de sensor af tot atmosferische druk. Druk daarna kort op  waarna het scherm 'WAIT' toont, na het verstrijken van 6 seconden heel kort 'CAL' toont om alvorens automatisch naar de volgende handeling te gaan.
7. Het scherm knippert APPLY/ REF/ PSI/ THEN/ PRESS/ ENTER/ TO/ START/ OR/ OTHER/ TO/ ABORT; voer nu de "volle

schaal"-waarde als 'psi'-grootheid in, zoals de uitlezing van de manometer vraagt. Druk kort op  waarna het scherm 'WAIT' toont en na het verstrijken van 6 seconden kortstondig 'CAL' alvorens automatisch naar de volgende handeling te gaan.

8. Het scherm knippert APPLY/ REF/ PSI/ THEN/ PRESS/ ENTER/ TO/ START/ OR/ OTHER/ TO/ ABORT; leg de druk aan, zoals die op de numerieke uitlezing van de manometer te zien is en druk op  waarna het scherm 'WAIT' toont en na het verstrijken van 6 seconden kortstondig 'GOOD' om vervolgens naar de meetmodus over te gaan.



Opmerking: Herkalibreren is uitsluitend toegestaan als de testparameters binnen een tolerantie van $\pm 7\%$ vallen. Als de waarden buiten dit venster vallen, dan zal het venster de volgende melding tonen CAL FAIL / INPUT PRES TOO LOW (HIGH) / PRESS ENTER TO RETRY / PRESS OTHER TO ABORT.

Opmerking: "De optie 'FIELD' verschijnt uitsluitend als de manometer met succes in het veld opnieuw werd gekalibreerd.



Staafigrafiek:

Stelt de gebruiker in staat de drukwaarden te wijzigen, welke de minimum/maximum-grenzen vormen voor de twintig segmenten die samen de staafigrafiek opbouwen.

1. Druk in menumodus kort op , , totdat 'GRAPH' verschijnt, druk daarna kort op .
2. Het scherm toont 'CGOFF'' (klantspecifieke staafigrafiek Uit) [verstekinstelling], "CG ON'' (klantspecifieke staafigrafiek Aan), of 'NEWCG'' (nieuwe klantspecifieke staafigrafiek). Druk kort op ,  om te bladeren.
3. Om de laatst ingevoerde klantspecifieke staafigrafiek terug te roepen als "CG ON" wordt getoond, drukt u kort op . Het scherm toont kortstondig 'DONE' en de meter keert terug naar de meetmodus.
4. Om de staafigrafiek terug te stellen naar het "volle schaal"-bereik als 'CGOFF' wordt getoond drukt u kort op . Het scherm toont kortstondig 'DONE' en de meter keert terug naar de meetmodus.
5. Om een nieuwe klantspecifieke staafigrafiek in te voeren als 'NEWCG' wordt getoond drukt u kort op .





6. Om het minimum grafische percentage te programmeren zal het scherm 0 0 uitlezen. Daarbij knippert het rechter cijfer. Voorts knippert het onderste segment van de staafgrafiek. Het scherm toont de melding 'PCTFS' (percentage van de "volle schaal"-waarde). Druk kort op ,  om naar een cijfer tussen 0 en 9 te bladeren. Druk op  om dat cijfer te selecteren. Nu zal het linker cijfer gaan knipperen. Druk kort op ,  om naar een cijfer tussen 0 en 9 te bladeren. Druk op  om dat cijfer te selecteren. Het op deze manier ingevoerde tweecijferige getal stelt het percentage voor van de "volle schaal"-waarde, dat als ondereind van de grafiek (0...99%) wordt gebruikt.

7. Om het maximumpercentage van de "volle schaal"-waarde te programmeren toont het scherm 1 0 0. Daarbij knippert het rechter cijfer. Voorts toont het scherm de melding 'PCTFS' (percentage van de "volle schaal"-waarde). Druk kort op ,  om naar een cijfer tussen 0 en 9 te bladeren. Druk op  om dat cijfer te selecteren. De beide linker cijfers gaan nu knipperen. Druk kort op ,  om naar een cijfer tussen 0 en 10 te bladeren. Druk op  om dat cijfer of het getal 10 te selecteren. Het op deze manier ingevoerde getal stelt het percentage voor van de "volle schaal"-waarde, dat als boveinde van de grafiek wordt gebruikt. **Opmerking:** 100 is het hoogste en enig mogelijke driecijferige getal. Als het laagste getal gelijk is aan of groter is dan het hoogste getal, dan zal de manometer knipperend 'REJECT' melden en terugkeren naar het submenu 'GRAPH'.

Opmerking: Een schermmelding 'ULOCK' wijst erop dat klantspecifieke eenheden worden toegepast en dat de ondergrens en bovengrens van de staafgrafiek zijn ingesteld op de verstekwaarden van de fabrikant.

Terugstellen:

Stelt het product weer in op de verstekwaarden van de fabrikant. De in het veld uitgevoerde kalibratie blijft behouden. U kunt de fabrieksijking weer herstellen vanuit het menu 'RECAL'.

Druk in de menumodus kort op ,  om totdat 'RESET' op de onderste regel in het scherm verschijnt. Druk kort op .

De verstekwaarden van de fabrikant hebben betrekking op eenheden, tijd klok, achterverlichting, ververstempo en nulvergrenzeling.

Het scherm toont 'DONE' waarna de manometer overschakelt naar de 'OFF'-stand.



6.0 VERVANGEN VAN DE BATTERIJ

De manometer wordt gevoed door twee alkalische 1,5 V-batterijen, modelgrootte AA. Bij normaal gebruik is de capaciteit van de batterijen voldoende voor ongeveer 2000 meeturen alvorens u de batterijen moet vervangen. De feitelijke levensduur van de batterij hangt sterk af van het gebruik van de manometer, van de omgevingstemperatuur en van andere factoren.

Vervang de batterijen op de manier als hieronder is beschreven:

1. Schuif de beschermhuls (niet afgebeeld) van de behuizing van de manometer weg.
2. Draai het geribbelde luikje aan de achterzijde tegen de richting van de klok in totdat het ontgrendelicoon met de pijl oplicht: op de behuizing staat deze pijl bij de voet van de drukaansluiting (zie afbeelding A).
3. Neem het luikje weg door deze recht naar achteren te trekken. Vervang de alkalische AA-batterijen. Let erop dat u de nieuwe batterijen in de juiste stand qua polariteit plaatst (zie afbeelding B).
4. Om het luikje weer aan te brengen lijnt u de ontgrendelicoon op met de pijl, duwt u het luikje er recht in en draait u het luikje met de richting van de klok mee tot deze oplicht met de grendelicoon (zie afbeelding C).
5. Plaats de beschermhuls (niet afgebeeld) terug over de behuizing van de manometer.

Opmerking: Het opnieuw plaatsen van het achterluikje kan ertoe leiden dat de manometer een negatieve drukwaarde uitleest. Dit is een tijdelijk verschijnsel omdat de inwendige druk van de behuizing verdwijnt als de behuizing afblaast en met de atmosferische druk vereffent (90%

van de nulpuntverschuiving effent binnen een minuut weg, de overige 10% kan vijf minuten vergen).

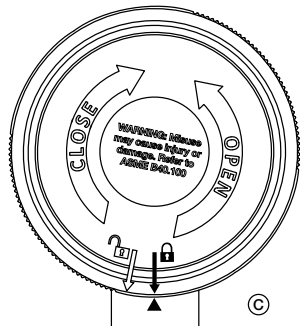
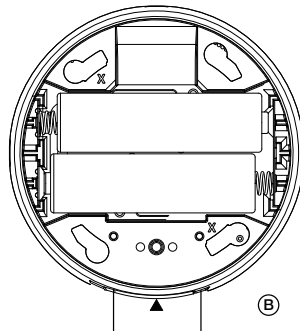
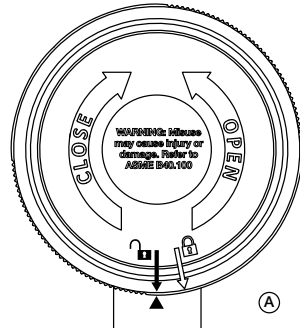

7.0 TECHNISCHE GEGEVENS - MODEL DGR-2 DIGITALE MANOMETER

Afmetingen:

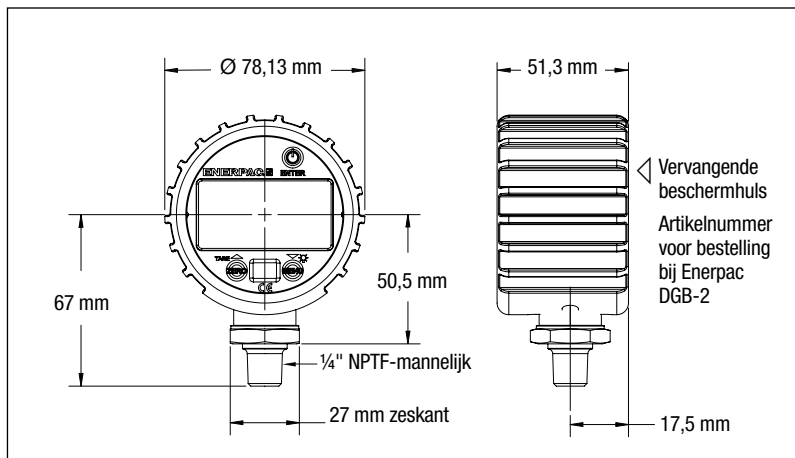

Specificaties:

Maximale drukwaarde				Nauwkeurigheid	Ververstempo	Vereiste voeding	Massa		Hydraulisch koppelstuk	Klassering van de behuizing
psi	bar	mPa	kg/cm ²	0.25%	250ms 500ms 1s (door gebruiker instelbaar)	3 V= (twee alkalische batterijen, modelgrootte AA)	lbs	kg	$\frac{1}{4}$ " NPTF- mannelijk	IP67
20000	1380	140	1400				0.5	0,23		
⚠ WAARSCHUWING: Overschrijd nimmer de maximaal toegelaten drukwaarde.										

Omgevingspecificaties	
	Acceptable Range
Omgevingsbedrijfs-temperatuur	-20° C tot 60° C
Hydraulische olietemperatuur	-20° C tot 80° C
Opslagtemperatuur (batterijen geplaatst)	-20° C tot 60° C
Opslagtemperatuur (batterijen uitgenomen)	-20° C tot 80° C
Temperatuurcoëfficiënt	0,04%/° F [-20 tot 180° C] nul en volle uitslag, referentietemperatuur 70° F

Informatie over bereik en resolutie		
Geselecteerde eenheid	Bereik	Resolutie
psi	0-20000	1
bar	0-1380	0.1
mPa	0-140	0.01
kg/cm ²	0-1400	0.1

Goedkeuringen van aangemelde instanties
CE EN 61326 (1998) CE EN 61326 Annex A (zwaar industrieel gebruik) UL/cUL-61010-1 (aangevraagd) In overeenstemming met RoHS

CE Dit meettoestel is in overeenstemming met de vereisten om een CE-merkteken te mogen voeren.

L4009 Rev. A 01/13

1.0 INSTRUÇÕES IMPORTANTES NO RECEBIMENTO

Inspecione visualmente todos os componentes verificando se houve avarias durante o transporte. Avarias no transporte não são cobertas pela garantia. Caso haja avarias no transporte, avise o transportador imediatamente. O transportador é responsável por todos os custos de consertos e substituições decorrentes de avarias ocorridas no transporte.

SEGURANÇA EM PRIMEIRO LUGAR

2.0 ASSUNTOS DE SEGURANÇA



Leia cuidadosamente todas as instruções, advertências e avisos sobre precaução. Siga todas as recomendações de segurança para evitar lesões pessoais ou danos à propriedade durante a operação do sistema. Enerpac não pode ser responsável por danos ou lesões pessoais resultantes do uso indevido do produto, falta de manutenção ou operação inadequada do produto e/ou sistema. Entre em contato com Enerpac quando houver dúvidas sobre as recomendações de segurança e operações. Se você nunca recebeu treinamento em segurança na hidráulica de alta pressão, consulte o seu distribuidor ou centro de serviço sobre um curso de segurança hidráulica Enerpac.

Falhas no cumprimento das advertências e avisos de precaução podem causar lesões pessoais e avarias ao equipamento.

PRECAUÇÃO é usada para indicar a operação correta ou os procedimentos e métodos de manutenção para prevenir o dano, a destruição do equipamento ou outras propriedades.

ADVERTÊNCIA indica um perigo potencial que exige procedimentos ou métodos corretivos para evitar lesões pessoais.

PERIGO é usado somente quando a ação ou a falta da mesma podem causar lesões sérias ou mesmo a morte.



ADVERTÊNCIA: Use equipamentos individuais de proteção quando acionar equipamentos hidráulicos.



ADVERTÊNCIA: Mantenha distância de cargas apoiadas por cilindros hidráulicos. Um cilindro, quando utilizado como dispositivo de levantamento, jamais deve ser usado como dispositivo de sustentação de carga. Depois de haver sido levantada ou baixada, a carga deve sempre ser bloqueada mecanicamente.



ADVERTÊNCIA: USE SOMENTE PEÇAS RÍGIDAS PARA APOIAR AS CARGAS. Selecione

cuidadosamente blocos de madeira ou ferro que sejam capazes de sustentar a carga. Nunca use um cilindro hidráulico como um calço ou espaçador em qualquer aplicação de levantamento ou prensagem.



PERIGO: Para evitar lesões pessoais mantenha mãos e pés longe do cilindro e da área de trabalho durante a operação.



ADVERTÊNCIA: Não exceda a capacidade do equipamento. Nunca tente levantar uma carga mais pesada que a capacidade do cilindro. Excesso de carga pode causar falhas no equipamento e possíveis lesões pessoais. Os cilindros são projetados para uma pressão máxima de 700 bar [10.000 psi]. Não faça a ligação entre um macaco ou um cilindro com uma bomba com capacidade maior de pressão.



Nunca ajuste uma válvula de alívio com pressão maior que a capacidade de pressão máxima da bomba. Ajustes maiores podem resultar em danos ao equipamento e/ou lesões pessoais.



ADVERTÊNCIA: A pressão de operação do sistema não deve exceder a capacidade de pressão do componente de menor capacidade no sistema. Instale manômetros de pressão no sistema para monitorar a pressão de operação. É a sua janela para o que está acontecendo no sistema.



PRECAUÇÃO: Evite danificar mangueiras hidráulicas. Evite curvas ou dobras pronunciadas quando direcionar as mangueiras hidráulicas. O uso de uma mangueira curvada ou dobrada causará aumento na pressão de retorno. Curvas ou dobras pronunciadas danificarão a mangueira internamente, levando a um desgaste prematuro.



Não derrube objetos pesados na mangueira. Um forte impacto pode causar danos à trama interna de aço da mangueira. A aplicação de pressão em uma mangueira danificada pode causar a sua ruptura.



IMPORTANTE: Não levante o equipamento hidráulico pela mangueira ou pelos engates. Use manoplas ou outros meios mais seguros para o transporte.



PRECAUÇÃO: Mantenha o equipamento hidráulico longe do calor e das chamas. O calor excessivo amolece vedações e selos, resultando em vazamento de fluidos. O calor também enfraquece o material das mangueiras e das juntas. Para um desempenho otimizado não exponha o equipamento a temperatura maiores que 65 °C [150 °F]. Proteja mangueiras e cilindros dos respingos de solda.



PERIGO: Não manuseie mangueiras pressurizadas. O escape do óleo sob pressão pode penetrar na pele, causando lesões sérias. Se o óleo penetrar na pele, procure um médico imediatamente.



ADVERTÊNCIA: Use somente cilindros hidráulicos num sistema acoplado. Nunca use um cilindro com engates não conectados.

Caso o cilindro se torne extremamente sobrecarregado, os componentes podem falhar catastróficamente, causando severas lesões pessoais.



ADVERTÊNCIA: ESTEJA CERTO QUE A MONTAGEM É ESTÁVEL ANTES DE LEVANTAR A CARGA.

Os cilindros devem ser colocados em superfícies planas que podem apoiar a carga. Quando aplicável, use uma base de cilindro Enerpac para aumentar a estabilidade. Não faça soldas ou, de qualquer forma, modifique o cilindro para acrescentar uma base ou outro apoio.



Evite situações em que as cargas não estão centradas na haste do cilindro. Cargas fora de centro podem causar deformações consideráveis nas hastes e nos cilindros. Além disso, a carga pode escorregar ou cair, causando resultados potencialmente perigosos.



Distribua a carga uniformemente em toda a superfície do assento. Use sempre um assento para proteger a haste.



IMPORTANTE: Somente técnicos em hidráulica, devidamente qualificados, devem fazer a manutenção de equipamentos hidráulicos. Para serviços de manutenção, entre em contato com o Centro de Serviço Autorizado Enerpac em sua área. Para proteger sua garantia, use somente óleo Enerpac.



ADVERTÊNCIA: Substitua imediatamente peças gastas ou danificadas por peças genuínas Enerpac. Peças não genuínas podem quebrar, causando lesões pessoais ou danos à propriedade. As peças Enerpac são projetadas para se encaixar adequadamente e sustentar cargas pesadas.

3.0 DESCRIÇÃO

O manômetro digital de pressão Enerpac DGR-2 é projetado para monitorar pressões do sistema de até 20.000 psi [1380 bar]. Características padrão incluem:

- Visor com disponibilidade para múltiplas unidades: psi, bar, mPa e kg/cm² (selecionável pelo usuário).
- Característica de reconfiguração para Zero garante que o manômetro leia a pressão real do sistema.
- Acionado por duas baterias de 1,5V AA (incluídas).
- Caixa com graduação, projetada segundo as normas IP 67
- Manômetro com Timer (temporizador) de desligamento selecionável pelo usuário.
- De acordo com CE e RoHS.

Nota: Veja a Seção 7.0 deste manual para especificações detalhadas do produto e dimensões de instalação.

4.0 INFORMAÇÕES SOBRE INSTALAÇÃO

IMPORTANTE: Para garantir uma operação adequada e evitar falhas do manômetro, leia e compreenda as instruções e os avisos de segurança a seguir, antes de instalar o manômetro.



AVISO: Uma falha, resultando em lesões pessoais e/ou danos à propriedade, pode ser causada por excesso de pressão, vibração demasiada ou oscilação de pressão, temperatura exagerada do instrumento, corrosão das partes que controlam a pressão, ou outras utilizações incorretas. Consulte Enerpac antes de instalar o manômetro, se houver perguntas ou preocupações.

Excesso de pressão:

Picos de excesso de pressão, a partir da pressão nominal do manômetro, podem causar danos elétricos e/ou mecânicos irreversíveis aos elementos de medição ou de controle de pressão. Variações rápidas de vazão dos fluidos podem destruir qualquer transdutor de pressão e devem ser evitadas sempre. Um amortecedor de pressão deve ser instalado para eliminar os efeitos prejudiciais das variações.

Impactos nos fluidos ocorrem quando a vazão de líquido é subitamente interrompida, como quando há um rápido fechamento das válvulas solenoides. Picos ocorrem quando a vazão é iniciada repentinamente, como quando a bomba é ligada com potência total ou uma válvula é aberta rapidamente.



AVISO: O manômetro é calibrado na pressão máxima de 20.000 psi [1380 bar]. Nunca exceda esta pressão nominal máxima.

Picos de Pressão:

Picos são particularmente prejudiciais aos manômetros de pressão, caso a tubulação esteja originalmente vazia. Para evitar picos de pressão, as linhas de fluido devem permanecer cheias (se possível), as bombas devem ser acionadas vagarosamente e as válvulas abertas lentamente. Para evitar danos causados por variações rápidas dos fluidos e picos, uma câmara de picos deveria ser instalada. Sintomas de variações rápidas dos fluidos e picos com efeitos prejudiciais:

- Manômetro digital indica deslocamento zero, fora de padrão, repetidamente.
- Mostrador do manômetro digital de pressão permanece constante independentemente da pressão.
- Código de Erro é mostrado na tela.

Baixas Temperaturas:

Formação de gelo na entrada do manômetro de pressão pode causar danos permanentes ao manômetro. Sempre que possível, monte o manômetro em posição vertical, o que ajuda a evitar possíveis danos de excesso de pressão causados pelo congelamento.

Nota: Inspetione o sistema hidráulico completo para vazamentos, caso haja suspeita de entrada de água no sistema. Faça os reparos necessários antes do sistema voltar a trabalhar.

Exigências para Instalação:

Uma porca sextavada de 1-1/16 pol [27 mm] é necessária para apertar o manômetro na ligação hidráulica. Aplique fita Teflon ou componente de vedação adequado nas roscas NPTF de ¼ pol do manômetro. Usando a tecla, aperte 1 volta além do aperto manual ou até que a vedação à prova de vazamento seja obtida.



⚠ PRECAUÇÃO: Apertar o manômetro segurando-o manualmente ou colocando uma ferramenta na carcaça plástica pode danificá-lo permanentemente.

5.0 INSTRUÇÕES DE OPERAÇÃO

LEGENDA:

- ① Alimentação Ligada-Desligada / Entre 
- ② Zero / Seta para Cima / Tara  ▲ Tara
- ③ Seleção do Menu / Para baixo / Seta de Iluminação Posterior  ▲ 
- ④ Toques consecutivos nas teclas são **cortos**  menos de 0,5 segundos, ou **muito longos**  – mais de 0,5 segundos)



Mostrador LCD com visor e funções:

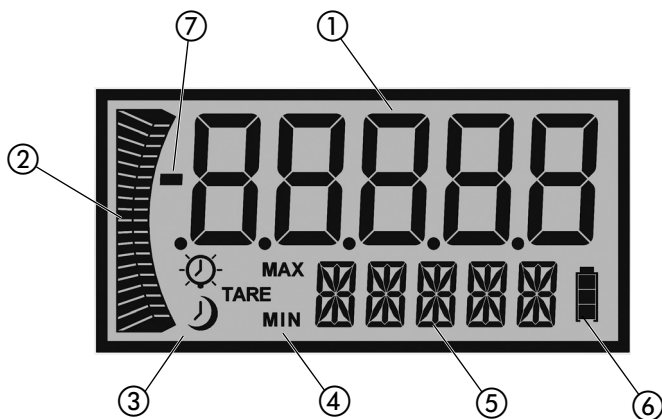

- ① 5 dígitos numéricos para exibição de pressão.
- ② Gráfico de barras com 20 segmentos de faixa de pressão – cada segmento é igual a 5% da faixa.
- ③ Símbolos de Timer (Temporizador) “Sleep” e Iluminação Posterior.
- ④ Ícones de Pressão Máxima / Mínima e Tara.
- ⑤ Exibição de 5 dígitos alfanuméricos.
- ⑥ Indicador de vida da bateria com 4 segmentos.
- ⑦ Indicador de Pressão Negativa.





Nota: Toques consecutivos nas teclas designados como curtos (menos de 0,5 seg) são indicados com “ ” ICONE “”.

Toques consecutivos nas teclas designados como longos (maiores que 0,5 seg.) são indicados com “” ICONE.

Gire o ON/OFF (Liga/Desliga) do Manômetro

Pressione a tecla   para ON / OFF (Ligar/Desligar) o manômetro. Quando ligado (ON) inicialmente, o visor vai mostrar momentaneamente todos os segmentos iluminados no LCD, versão do produto e faixas da escala total; então, a unidade prossegue automaticamente para o Modo de Medições.

Função Zero:

Pressione a tecla  . Depois de liberado, o mostrador numérico desaparece momentaneamente e “ZERO” em alfa aparece no visor, depois volta para o Modo de Medições. A pressão, agora, deve ler 0. Valor Zero é armazenado na memória.



Nota 1: Uma mensagem “RLOCK” no mostrador indica que zero é maior do que $\pm 5\%$ da calibração de fábrica. Não é possível zerar.

Nota 2: Uma mensagem “ZLOCK” indica que a função de trava de zero está ativada.



Função de Tara:





Subtraia o valor da pressão atual do valor indicado no Modo de Medição.

No Modo de Medição aplique a pressão desejada e pressione **ZERO**  , para habilitar a função tara. O visor emite um rápido sinal de “TARE”, depois o ícone “TARE” será mostrado e a leitura da pressão vai piscar. A unidade agora deve ler 0. Pressione **ZERO**  novamente para desabilitar a função tara. O mostrador vai piscar rapidamente “T OFF”, depois o ícone “TARE” desaparece e a leitura de pressão não estará mais piscando. A unidade agora retorna para o Modo de Medições.







Programando:

Para entrar no Modo Menu

1. Pressione **MENU**  e libere para continuar o modo Programação.
2. Pressione **▲**, **▼**  , para navegar pelas opções programáveis do menu.
3. Quando a opção desejada for alcançada pressione **ENTER**  para acessar aquele parâmetro.
4. Se em qualquer momento você escolher SAIR do Modo Menu (ou modo sub-menu) segure **MENU**  . Seu trabalho não será salvo.

Parâmetros Programáveis:



Unidades de Medida:

1. No Modo Menu, pressione **▲**, **▼**  , para navegar para as “UNITS”, pressione **ENTER**  .
2. Escolha as unidades de engenharia, navegando **▲**, **▼**  , até que a unidade desejada seja mostrada, “PSI, BAR, kg/cm, mPa, unidades definidas pelo usuário (CUSTM)”.
3. Pressione **ENTER**  para selecionar as unidades e volte para o Modo de Medição.



Nota: Programação de unidades customizadas, veja página 104.

Unidades de medida customizadas:

Para permitir que o usuário defina uma unidade customizada de medida, a escala total das leituras desejadas deve ser incluída pelo usuário, o que pode ser feito como segue:

1. No Modo Menu pressione ,  →, selecione “CUSTM”, pressione  →.
2. Selecione a localização do ponto decimal:



O mostrador alfanumérico deve mostrar “SELDP”.



A primeira tela a aparecer vai mostrar todos os dígitos iluminados como “5” e o ponto decimal mais à direita vai piscar (5 5 5 5.5) a menos que o dispositivo de unidades customizadas tenha sido usado anteriormente. Caso tenha sido usado anteriormente, os dígitos e posições dos pontos decimais devem corresponder aos últimos valores definidos. Use as teclas ,  → para mover o ponto decimal para a esquerda ou para a direita. Uma vez que o ponto decimal está na posição desejada, pressione  → para travar em posição. Quando a tecla for liberada, o mostrador vai indicar “DIGIT”.



3. Escolha o valor na escala total:

O mostrador alfanumérico deve indicar “DIGIT”.

A próxima tela continuará mostrando todos os dígitos como “5”, com o dígito mais à esquerda piscando e o ponto decimal fixado na posição previamente escolhida. Entretanto, se as características personalizadas das unidades tiverem sido usadas anteriormente, então os dígitos devem corresponder ao último valor. O ponto

decimal permanece na localização escolhida no passo 1. Pressione ,  → para mudar o valor do dígito entre 0-9.

Uma vez que o valor desejado é mostrado, pressione o botão  → para travar em posição. Agora o próximo dígito à direita começa a piscar. Repita este procedimento para todos os 5 dígitos. Quando  → é pressionado e liberado com todos os cinco dígitos piscando, o manômetro mostrará brevemente “DONE” voltando então para o modo de Medições e mostrando “CUSTM” juntamente com as leituras numéricas para indicar que o dispositivo está em uso.









Como opção, o usuário pode sair em qualquer ponto antes de pressionar a tecla de entrada com  →. Se o usuário sai do menu por um  → antes de completar o passo 2 ou se houver um tempo limite do menu, então tudo o que o usuário digitou será perdido.

Nota: A barra de gráficos utiliza a configuração padrão de fábrica, quando as unidades personalizadas são usadas.

Nota: A magnitude do valor introduzido quando se usa o dispositivo com unidades customizadas pode aumentar significativamente o ruído no mostrador, o que em geral afeta as funções de zero e tara, assim como a estabilidade da leitura de pressão indicada. Se necessário, consulte a fábrica para recomendações sobre limitações na entrada da escala total.

Máximo / Mínimo:

Mostra valores máximo / mínimo de pressão; isto é iniciado depois do acionamento da unidade ou quando os valores tiverem sido desmarcados.









1. Quando no Modo Menu pressione ,  para navegar para 'Max' (mostra o máximo); isto é indicado em letra pequena à esquerda do visor na unidade de medição.
2. Para limpar *ambos* os valores, mínimo e máximo, pressione e segure  .
3. Liberação desta tecla vai deixá-lo no Modo Menu. Usar ,  para continuar rolando através das opções do menu, OU segure,   para retornar ao Modo de Medições.

Nota: Desmarcar os Valores Mínimo/Máximo vai resultar em um mostrador em branco exceto para a associação com o ícone Mín./Máx. e o indicador da bateria.

Nota: as seguintes ações vão zerar os valores de mínimo e máximo: Desligar, função zero do manômetro, função de tara, função de calibragem no campo, unidades de programação, taxa de atualização ou reconfiguração.

Temporizador:

Controla o tempo que o manômetro permanece LIGADO, quando o botão de Acionamento  for pressionado.





1. Quando em Modo Menu pressione ,  para navegar até que "TIMER" apareça.
2. Pressione  .
3. Então, aperte ,  para rolar entre os valores. "NONE" significa que o manômetro permanece ON (ligado) até que o botão de acionamento  seja pressionado uma segunda vez. Qualquer outro valor (1 min [default] / 5 min / 20 min), exceto "NONE", designará a duração de tempo de efeito desta função.
4. Aperte   para selecionar o valor desejado; o ícone do temporizador será mostrado e a unidade mostrará "DONE" e retornará para o Modo de Medição.

Característica: o ícone do Temporizador vai piscar por 10 segundos antes de o manômetro desligar. Enquanto o manômetro estiver ligado, qualquer tecla pressionada vai reconfigurar o temporizador.



Light: (Luz)

Determina quanto tempo a iluminação posterior ficará ON depois que qualquer tecla for pressionada nos Modos de Medição ou Menu. (Nota: o temporizador é reconfigurado quando qualquer tecla for pressionada)

1. Enquanto no Modo Menu, aperte ,  até que “LIGHT” seja mostrado.
2. Aperte  para que o valor do temporizador apareça; “ON” refere-se a iluminação posterior que fica ON (ACESA) durante todo o tempo que a unidade estiver ligada, “PRESS” informa que a iluminação posterior está on/off apertando rapidamente iluminação posterior  enquanto “OFF” indica que a iluminação posterior nunca será iluminada. Selecionando valores de tempo, “1 MIN” (padrão), “5 MIN”, “20 MIN”, ativará o símbolo de iluminação posterior no mostrador LCD para os minutos designados.
3. Pressione  para selecionar iluminação posterior (“DONE” aparecerá rapidamente no mostrador) e retornará para o Modo de Medição.







Nota: Em modo “PRESS”, o ajuste de fábrica é de 1 hora para economizar a bateria.

Característica: o indicador da iluminação posterior piscará 10 segundos antes do desligamento.



Atualização:

É utilizado para selecionar a faixa na qual a pressão do manômetro será atualizada na tela. Esta função é usada quando mudanças rápidas na pressão causam agitações nos valores do mostrador; intervalos mais longos reduzirão a taxa de atualização e farão uma média nas leituras de tais aplicações.







1. No Modo Menu, pressione ,  até que “UPDAT” apareça.
2. Aperte  para selecionar.
3. Aperte ,  para selecionar valores para “1 SEG” (default/padrão), “500 MSEG”, ou “250 MSEG”.
4. Aperte  para selecionar o valor (“DONE” aparecerá rapidamente no mostrador) e retornará ao Modo de Medição.

Nota: mudar o valor para qualquer outro que não 1 segundo pode causar um deslocamento pequeno do zero, e é recomendado que o manômetro seja totalmente ventilado e zerado antes que uma nova leitura acurada seja tirada. Ainda, a vida útil da bateria será reduzida pelo uso de uma taxa de atualização mais rápida que 1 SEG.



Z-Lock:

Utilizado para que, por descuido, se evite zerar novamente o manômetro.











1. No Modo Menu, pressione ,  até que “ZLOCK” apareça.
2. Aperte  para selecionar.
3. Aperte ,  para selecionar “L ON” ou “L OFF” (default).
4. Aperte  para selecionar válvula (“DONE” aparecerá rapidamente no mostrador) e retornará ao Modo de Medição.

Nota: se Z-Lock for ativado, o manômetro mostrará “ZLOCK” se zero for tentado.



Recalibração:

Dá ao usuário a habilidade de calibrar o produto no campo. A calibração original de fábrica fica retida permanentemente na memória e pode ser recuperada a qualquer tempo.

1. No modo Menu, aperte ,  até que “RECAL” apareça; continue pressionando .
2. O mostrador indicará “FACT” (fábrica) “FIELD” ou “NEW”. Pressione ,  para navegar.
3. Apertando  enquanto “FACT” (fábrica) é mostrado vai restaurar a calibração de fábrica.
4. Apertando  enquanto “FIELD” é mostrado vai restaurar a última calibração de campo.
5. Apertando a tecla “Enter”  enquanto “NEW” aparece vai inserir o modo Recalibração. .
6. Quando “NEW” aparecer, aperte ; ao liberar, o mostrador vai piscar “OK/ APPLY/ REF/ PSI/ THEN/ PRESS/ ENTER/ TO/ START/ OR/ OTHER/ TO/ ABORT”. O mostrador numérico vai ler ,0000. Ventile o sensor para pressão atmosférica, pressione  o mostrador agora mostrará “WAIT” e a contagem regressiva a partir de 6 segundos, então indicará brevemente CAL, passando automaticamente para o próximo passo.
7. O mostrador piscará: “APPLY/ REF/ PSI/ THEN/ PRESS/ ENTER/ TO/ START/ OR/ OTHER/ TO/ ABORT”; aplique pressão total nas unidades de psi indicadas no mostrador numérico do manômetro. Aperte  o mostrador mostrará “WAIT” e a contagem regressiva

a partir de 6 segundos, então indicará brevemente CAL, passando automaticamente para o próximo passo.











8. O mostrador pisca “APPLY/ REF/ PSI/ THEN/ PRESS/ ENTER/ TO/ START/ OR/ OTHER/ TO/ ABORT”; aplique a pressão indicada no mostrador numérico do manômetro e aperte  o mostrador vai mostrar “WAIT” e a contagem regressiva a partir de 6 segundos, então indicará brevemente GOOD, passando para o Modo de Medição.

Nota: A recalibração é permitida apenas se os parâmetros de teste estiverem dentro de $\pm 7\%$. Se estiver fora desta janela, o mostrador indicará “CAL FAIL / INPUT PRES TOO LOW (HIGH) / PRESS ENTER TO RETRY / PRESS OTHER TO ABORT”.







Nota: a opção “FIELD” aparece apenas se o manômetro tiver sido recalibrado com sucesso no campo.







Gráfico:

Dá ao usuário a habilidade de modificar a pressão das válvulas ditando as indicações de mínimo e o máximo sobre um gráfico de barra com 20 segmentos.

1. No Modo Menu, aperte , , , até que “GRAPH” apareça, aperte  o mostrador vai mostrar “CGOFF” (gráfico customizado/desligado) [default/padrão], “CG ON” (gráfico customizado/ligado), ou “NEWCG” (novo gráfico customizado). Aperte , ,  para navegar.
3. Para recuperar a última entrada customizada de gráfico quando “CG ON” é mostrado pressione  o mostrador indicará brevemente “DONE” e retornará para o Modo de Medição.
4. Para restabelecer o gráfico de barras em sua capacidade total; enquanto “CGOFF” estiver aparecendo aperte  o mostrador vai indicar brevemente “DONE” e retornará ao Modo de Medição.
5. Para entrar um novo gráfico de barra customizado: enquanto “NEWCG” estiver indicado, aperte  o mostrador vai mostrar “WAIT” e a contagem regressiva a partir de 6 segundos, então indicará brevemente GOOD, passando para o Modo de Medição.





6. Para programar a porcentagem mínima do gráfico, o mostrador vai indicar 0 0 com o dígito da direita piscando, o segmento mais baixo do gráfico de barras vai piscar, e o mostrador vai mostrar "PCTFS" (porcentagem da escala total). Pressione   para navegar até um número entre 0-9. Aperte  para selecionar este número. O dígito da esquerda começará a piscar. Aperte ,  para escolher um número de 0-9. Aperte  para selecionar o número. O número com 2 dígitos inserido representa a porcentagem da escala total a ser usada como limite inferior do gráfico (0-99%).

7. Para programar a porcentagem máxima da escala total o mostrador vai indicar 1 0 0 com o dígito da direita piscando, o maior segmento superior do gráfico vai piscar e o mostrador vai ler PCTFS (porcentagem da escala total). Aperte ,  para escolher um número entre 0-10. Aperte  para selecionar este número. Os dois dígitos da esquerda começarão a piscar. Aperte ,  para escolher um número entre 0-10. Aperte  para selecionar o número. O número digitado representa a porcentagem da escala total a ser usada como o limite superior do gráfico. Nota: 100 é o mais alto e único número possível com 3 dígitos. Se o número mais baixo for igual ou maior do que o número mais alto, a unidade vai piscar "REJECT" e vai voltar ao sub-menu "GRAPH".

Nota: a mensagem "UNLOCK" no mostrador indica que as unidades customizadas estão sendo usadas e o mínimo e máximo do gráfico de barras foram calibrados para o padrão de fábrica.

Reset (Reconfiguração):

Retorna o produto aos valores padrão de fábrica. Mantém a calibração de campo. A calibração de fábrica pode ser restaurada no menu "RECAL".

No modo Menu pressione ,  até que "RESET" apareça na linha inferior do mostrador. Pressione .

Padrões de fábrica estão relacionados a unidades, temporizador, iluminação posterior, taxa de atualização, trava de zero.

Mostrador indicará "DONE", então o manômetro vai alternar para a condição "OFF".



6.0 SUBSTITUIÇÃO DE BATERIAS

O manômetro é acionado por duas baterias alcalinas tipo AA de 1,5 volts. No trabalho normal, as baterias durarão aproximadamente 2.000 horas antes que sua substituição seja necessária. A duração real da bateria varia, dependendo da utilização do manômetro, temperatura ambiente e outros fatores.

Substitua as baterias conforme descrito no procedimento seguinte:

1. Deslize a capa protetora (não mostrado) para fora da carcaça do manômetro.
2. Aperte a tampa traseira serrilhada e gire no sentido anti-horário até que o ícone 'unlock' (destravado) esteja alinhado com a seta – este aparece na carcaça, na base da ligação de pressão (ver vista A).
3. Remova a tampa, puxando-a para trás e substitua as baterias alcalinas AA, de acordo; certifique-se de que as baterias estão na posição polarizada correta (ver vista B).
4. Para reinserção da tampa, alinhe o ícone 'unlock' com a seta, coloque a tampa em linha reta e então gire no sentido horário até que a seta esteja alinhada com o ícone 'Lock' (ver vista C).
5. Reinstale a capa protetora (não mostrado) na carcaça do manômetro.

Nota: A reinstalação da tampa traseira pode fazer com que o manômetro faça leitura negativa de pressão. Este é um problema temporário, uma vez que a pressão interna do compartimento será liberada pela ventilação e equilibrada com a pressão atmosférica (90% do deslocamento será equilibrados dentro de 1 minuto, os 10% restantes podem levar até 5 minutos).

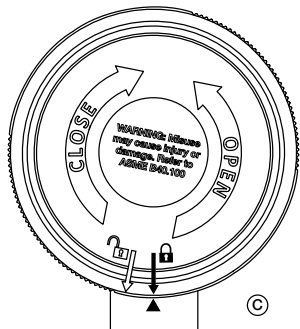
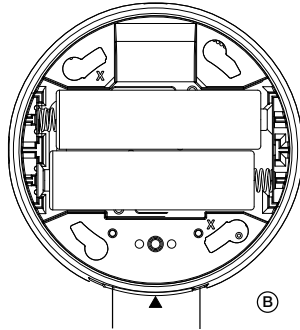
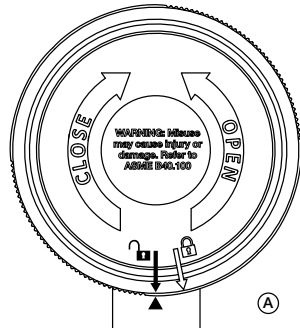

7.0 DADOS TÉCNICOS – MANÔMETRO DIGITAL DE PRESSÃO DGR-2

Dimensões:

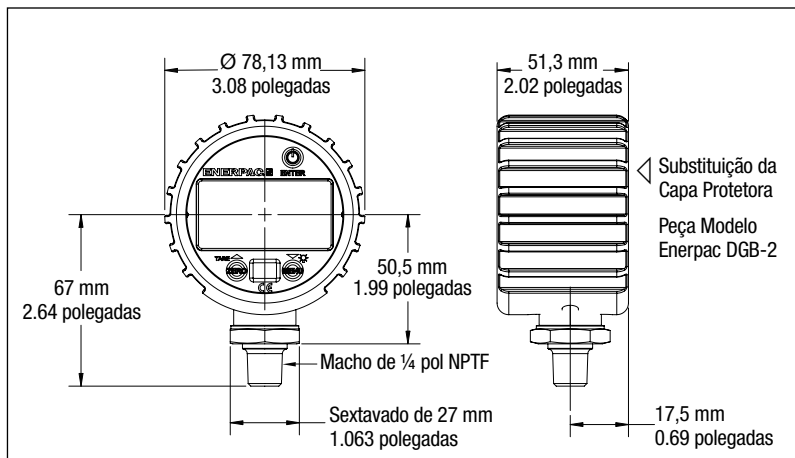

Especificações:

Pressão Nominal Máxima				Precisão	Taxa de Atualização	Força Necessária	Peso		Ligação Hidráulica	Gradação do compartimento
psi	bar	mPa	kg/cm ²	0.25%	250ms 500ms 1s (selecionável pelo usuário)	3 VDC (duas baterias alcalinas AA)	libras	kg	Macho de ¼ pol NPTF	IP67
20000	1380	140	1400		0.5	0.23				
AVISO: Nunca exceda a pressão nominal máxima.										

Especificações Ambientais	
	Alcance Aceitável
Temperatura Ambiente de Operação	-20°C para 60°C [4°F para 140°F]
Temperatura do Óleo Hidráulico	-20°C para 80°C [4°F para 176°F]
Temperatura de Armazenamento (baterias instaladas)	-20°C para 60°C [4°F para 140°F]
Temperatura de Armazenamento (baterias removidas)	-20°C para 80°C [4°F para 176°F]
Coefficiente de Temperatura	0,04%/°F [-20°C para 180°C] zero e "span", referência de temperatura 70°F

Informação sobre Alcance e Intervalo		
Unidade de Medição Selecionada	Alcance	Intervalo
psi	0-20000	1
bar	0-1380	0.1
mPa	0-140	0.01
kg/cm ²	0-1400	0.1

Aprovação de Agências
CE EN 61326 (1998) CE EN 61326 Anexo A (Industrial pesada) UL/cUL-61010-1 (pendente) RoHS de acordo

Este dispositivo está de acordo com as exigências de Marcação da CE.

L4009 Rev. A 01/13

1.0 VIKTIGE INSTRUKSJONER VED MOTTAK

Kontroller alle komponenter visuelt for transportskader. Transportskader dekket ikke av garantien. Hvis det foreligger transportskader må fraktselskapet varsles umiddelbart. Fraktselskapet er ansvarlig for alle reparasjons- og erstatningsvarekostnader som er resultat av skade under transport.

SIKKERHETEN FØRST

2.0 SIKKERHETS PUNKTER



Les alle instruksjoner, advarsler og forsiktighetsregler nøye. Følg alle sikkerhetsregler for å unngå personskader eller materielle skader under bruk av systemet. Enerpac påtar seg ikke ansvar for skader eller personskader som følge av at produktet brukes på en mindre sikker måte eller ikke vedlikeholdes, eller som følge av feil bruk av produktet og/eller systemet. Kontakt Enerpac når du er i tvil om sikkerhetsregler og bruksmåter. Hvis du aldri har fått opplæring om sikkerhet i forbindelse med høytrykkshydraulikk, bør du kontakte din forhandler eller ditt servicesenter for å få gratis sikkerhetskurs for hydraulikk fra Enerpac.

Hvis du ikke overholder de etterfølgende forsiktighetsregler og advarsler kan det føre til materielle skader og personskader.

FORSIKTIG brukes for å indikere korrekte drifts- eller vedlikeholdsprosedyrer og -praksis for å avverge skade på eller ødeleggelse av utstyr eller annen eiendom.

ADVARSEL indikerer en mulig fare som krever korrekte prosedyrer eller praksiser for å unngå personskader.

FARE brukes kun når dine handlinger eller manglende handlinger kan føre til alvorlige skader eller død.



ADVARSEL: Bruk egnet personlig verneutstyr når du bruker hydraulisk utstyr.



ADVARSEL: Hold sikker avstand til last som holdes oppe av hydraulikk. En sylinder som brukes til å løfte en last må aldri brukes til å holde lasten. Når lasten har blitt løftet eller senket, må den alltid blokkeres mekanisk.



ADVARSEL: BRUK KUN SOLIDE DELER TIL Å HOLDE LASTER.

Være nøye med å velge stål- eller treklosser som kan holde lasten. Bruk aldri en hydraulisk sylinder som en foring eller avstandshylse ved løft eller press.



FARE: For å unngå personskade må hender og føtter holdes unna sylinder og arbeidsstykke under arbeid.



ADVARSEL: Ikke overskrid utstyrets spesifikasjoner. Prøv aldri å løfte en last som veier mer enn sylinderens kapasitet. Overlast fører til at utstyret bryter sammen, og til mulig personskade. Sylindere er konstruert for et maks. trykk på 700 bar [10 000 psi]. Ikke kople jekk eller sylinder til en pumpe med høyere trykkspesifikasjoner.



Sett aldri sikkerhetsventilen på et høyere trykk enn pumpens maksimale trykkapasitet. Høyere innstilling kan føre til skade på utstyret og/eller personskade.



ADVARSEL: Systemets driftstrykk må ikke overskride trykkspesifikasjonene for den komponenten i systemet som har lavest spesifikasjon. Monter manometeret i systemet for å overvåke driftstrykket. Dette er ditt vindu hvor du kan se hva som skjer i systemet.



FORSIKTIG: Unngå skader på hydrauliske slanger. Unngå bøyning og krølling når de hydrauliske slangene legges ut. Å bruke en bøyd eller krøllet slange vil skape et alvorlig mottrykk. Skarpe bøyer eller krøll vil umiddelbart skade slangen og føre til tidlig slangefeil.



Ikke slipp tunge gjenstander på slangen. Et hardt slag kan føre til skade på slangens armering. Å sette trykk på en skadet slange kan få den til å revne.



VIKTIG: Ikke løft hydraulisk utstyr etter slanger eller sveiselkoplinger. Bruk bærehåndtaket eller andre metoder for sikker transport.



FORSIKTIG: Hold hydraulisk utstyr unna flammer og varme. For sterk varme vil gjøre pakninger og tetninger myke, og føre til væskelekkasjer. Varme svekker også slangematerialer og pakninger. For å beholde optimale ytelser, skal utstyret ikke utsettes for temperaturer på 65 °C [150 °F] eller høyere. Beskytt slanger og sylindere fra sveisepрут.



FARE: Ikke håndter trykksatte slanger. Olje under trykk som lekker ut, kan trenge gjennom huden og forårsake alvorlige skader. Hvis olje blir sprøytet inn gjennom huden må man oppsøke lege umiddelbart.



ADVARSEL: Bruk kun muttetrekkere i et tilkoblet system. Bruk aldri en muttetrekker uten tilkoblede koblinger. Hvis muttetrekkeren blir ekstremt overbelastet kan komponenter feile katastrofalt og forårsake alvorlige personskader.



ADVARSEL: SØRG FOR AT OPPSETTET ER STABILT FØR LAST LØFTES. Sylindere skal plasseres på et plant underlag som kan bære lasten. Ved behov skal det brukes grunnplate på sylindere for å øke stabiliteten. Ikke bruk sveising eller modifierer sylindere på annen måte for å feste en grunnplate eller annen støtte.



Unngå situasjoner der last ikke er direkte sentrert på sylindere stempel. Skjev last gir stor belastning på sylindere og stempel. I tillegg kan lasten gli eller falle, og skape potensielt farlige situasjoner.



For del lasten jevnt over hele trykkhodets overflate. Bruk alltid trykkhode for å beskytte stempelet



VIKTIG: Hydraulisk utstyr må kun repareres av en kvalifisert servicemekaniker. For reparasjoner, kontakt et autorisert ENERPAC servicesenter i ditt distrikt. For å beholde garantien din må du kun bruke ENERPAC olje.



ADVARSEL: Skift umiddelbart ut slitte og skadde deler med originale ENERPAC deler. Deler i ordinær kvalitet vil svikte, med personskader og materielle skader som resultat. ENERPAC deler er konstruert for å passe riktig og for å motstå høye belastninger.

3.0 BESKRIVELSE

Enerpac DGR-2 digital trykkmåler er designet for å overvåke systemtrykk på opptil 1 380 bar [20 000 psi]. Standardfunksjoner inkluderer:

- Visninger tilgjengelig i flere enheter: psi, bar, mPa og kg/cm² (brukervalg).
- Nullstillingsfunksjon som sørger for at måleren leser det aktuelle systemtrykket.
- Drevet av to stk. 1,5 V AA batterier (inkludert).
- IP67-gradert huskonstruksjon.
- Brukervalgt tidsur for å slå måleren av.
- Oppfyller kravene til CE og RoHS.

Merk: I avsnitt 7.0 i denne håndboken finner du detaljerte produktspesifikasjoner og installasjonsdimensjoner.

4.0 INSTALLASJONSINFORMASJON

VIKTIG: For å sikre korrekt funksjon og for å unngå målersvikt, må du lese og forstå følgende instruksjoner og forholdsregler før du installerer måleren.



ADVARSEL: En svikt som fører til personskade og/eller materiell skade kan forårsakes av for stort overtrykk, kraftige vibrasjoner eller trykkvibrasjoner, for høy instrumenttemperatur, korrosjon på trykkkontrollerende deler eller annen misbruk. Ta kontakt med Enerpac før du installerer måleren hvis du har spørsmål eller er i tvil.

Overtrykk:

Trykktopper over det nominelle trykket til måleren kan forårsake varig elektrisk og/eller mekanisk skade på trykkmålende og trykkkontrollerende elementer. Væskeslag og -støt kan ødelegge enhver trykksender, og må alltid unngås. Det bør installeres en trykkdemper for å fjerne skadelige slageffekter. Væskeslag oppstår når en væskestrøm plutselig stoppes, som når solenoidventiler lukkes brått. Støt oppstår når en strømning plutselig starter, som når en pumpe slås på med full kraft eller en ventil åpnes raskt.



ADVARSEL: Måleren har et nominelt maksimumstrykk på 1 380 bar [20 000 psi]. Du må aldri overskride denne maksimumsverdien.

Trykkstøt:

Støt er spesielt skadelige for trykkmålere hvis røret opprinnelig er tomt. For å unngå trykkstøt, må væskerør være fulle (hvis mulig), pumpene må startes sakte og ventilene må åpnes gradvis. For å unngå skade både fra væskeslag og trykkstøt, bør det installeres et svingkammer. Symptomer på væskeslagenes og trykkstøtenes skadelige virkninger:

- Den digitale måleren viser et stort nullavvik.
- Den digitale målerens trykkvisning er konstant, uansett trykk.
- Det vises en feilkode på skjermen.

Kalde temperaturer:

Isdannelse i målerens trykkport kan føre til varig skade på måleren. Når det er mulig, bør måleren monteres i vertikal stilling for å hjelpe til å unngå mulig overtrykksskade som skyldes frost.

Merk: Inspiser hele det hydrauliske systemet for lekkasjer hvis du mistenker at det har kommet vann i systemet. Gjør nødvendige reparasjoner før systemet settes tilbake i drift.

Krav til installasjonen:







Det kreves en 27 mm [1-1/16 tommer] sekskantnøkkel for å skru måleren fast i den hydrauliske koblingen. Legg Teflon-tape eller et passende tetningsmiddel på 1/4 tomme av målerens NTPF-gjenger. Bruk nøkkelen og skru 1 omdreining mer enn håndkraften klarer, eller til du oppnår en lekkasjesikker tetning.



OBS: Å stramme til måleren ved å gripe eller bruke verktøy på plathuset kan føre til varig skade på måleren.

5.0 BRUKSINSTRUKSJONER

Tastatur:

- ① Strøm på/av / Enter 
- ② Null / Opp-pil / Tara  ▲ Tara
- ③ Menyvalg / Ned / Bakgrunnslyspil  ▲ 
- ④ Tastetrykk er **korte**  under 0,5 sekunder, eller **lange**  – over 0,5 sekunder



LCD-skjerm og funksjoner:

- ① 5 sifre for trykkvisning.
- ② Trykkområde med 20 segmenter - hvert segment indikerer 5 % av området.
- ③ Symboler for dvale og bakgrunnlystiller.
- ④ Ikoner for maksimum/minimum trykk og tara.
- ⑤ 5-tegns alfanumerisk display.
- ⑥ 4-segmenters batteriindikator.
- ⑦ Negativ trykkindikator.

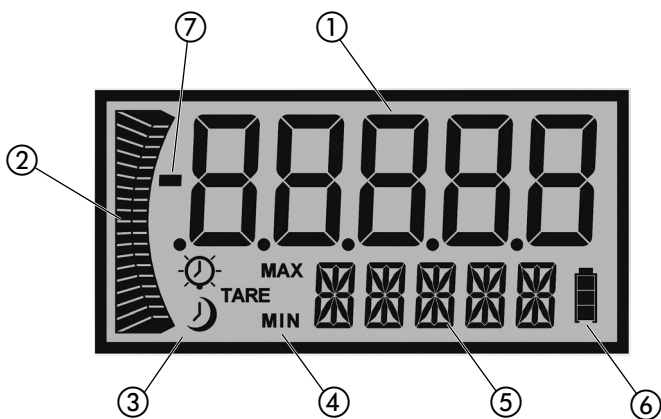

Merk: Tastetrykk som skal være korte (under 0,5 sekunder) indikeres med ikonet "⏏" ICON

Tastetrykk som skal være lange (over 0,5 sekunder) indikeres med ikonet "⏏" .

Slå måleren PÅ/AV

Trykk på tasten  ⏏ for å slå måleren PÅ/AV. Når måleren første gang slås PÅ, vil skjermen en kort stund vise alle LCD-segmentene opplyst, produktversjon og fullt skalaområde. Deretter vil enheten automatisk gå til målingsmodus.

Nullfunksjonen:



Trykk på  ⏏ . Når du slipper vil det numeriske displayet forsvinne en stund og "ZERO" vises på det alfanumeriske displayet. Deretter går måleren tilbake til målingsmodus. Trykket skal nå vise 0. Nullverdien lagres i minnet.

Note 1: Displaymeldingen "RLOCK" indikerer at null er mer enn ± 5 % fra fabrikkinnstillingen. Nullstilling er ikke mulig.

Note 2: Meldingen "ZLOCK" indikerer at null-låsefunksjonen er aktivert.

Tarafunksjonen:





Trekker den aktuelle trykkverdien fra verdien som vises i målingsmodus.

I målingsmodus, setter du på ønsket trykk og trykker på  ⏏ for å aktivere tarafunksjonen. Displayet vil raskt blinke "TARE", deretter vil ikonet "TARE" vises og trykkavlesningen vil blinke. Enheten skal nå vise 0. Trykk på  ⏏ igjen for å deaktivere tarafunksjonen. Displayet vil raskt blinke "T OFF", deretter vil ikonet "TARE" vises og trykkavlesningen vil ikke lenger blinke. Enheten vil nå returnere til målingsmodus.









Programmering:

Slik aktiveres menymodus:

1. Trykk på  og slipp for å gå til programmeringsmodus.
2. Trykk på , , for å bla gjennom de programmerbare menyvalgene.
3. Når det ønskede valget nås, trykk på  for å gå inn på denne parameteren.
4. Hvis du på ethvert tidspunkt velger å avslutte (EXIT) menymodus (eller undermenymodus) holder du inne  . Arbeidet vil ikke bli lagret.

Programmerbare parametere:

Måleenheter:





1. I menymodus, trykk på , , for å bla til "UNITS" (Enheter), og trykk på .
2. Velg tekniske enheter ved å bla i , , til den ønskede enheten vises, "PSI, BAR, kg/cm, mPa, kundefinerte enheter (CUSTM)".
3. Trykk på  for å velge enheter og returnere til målingsmodus.

Merk: Programmering av egendefinerte enheter, se side 120.



Egendefinerte måleenheter:

Lar brukeren definere sin egen måleenhet. Brukeren må angi hele skalaverdien til den ønskede avlesningen, noe som gjøres på følgende måte.



1. I menymodus, trykk på ,  , velg "CUSTM" og trykk på  .
2. Velg plassering av desimaltegnet:





Det alfanumeriske displayet skal vise "SELDP".





Det første skjermbildet som vises vil vise alle tall opplyst som "5", og desimalpunktet helt til høyre vil blinke (5 5 5 5.5), med mindre funksjonen for egendefinerte enheter har blitt benyttet tidligere. Hvis denne funksjonen har blitt benyttet, skal tallene og desimaltegnet tilsvare de siste innstilte verdiene. Bruk tastene ,   til å flytte desimaltegnet til venstre eller høyre. Når desimaltegnet er på ønsket plass, trykk på   for å låse det på plass. Når tasten slippes, viser displayet "DIGIT".

3. Velg full skalaverdi:

Det alfanumeriske displayet skal vise "DIGIT".

Det neste skjermbildet vil fortsette å vise alle tall som "5", tallet helt til venstre blinker og desimaltegnet står i stillingen som ble valgt i forrige trinn. Hvis funksjonen for egendefinerte enheter har blitt benyttet tidligere, skal tallene tilsvare siste innstilte verdi. Desimaltegnet befinner seg på plassen som ble valgt i trinn 1. Trykk på ,   for å endre verdi for tallene mellom 0-9.

Når den ønskede verdien vises, trykk på knappen   for å låse den på plass. Nå vil neste tall til høyre begynne å blinke. Gjør denne prosedyren for alle 5 tallene. Når du trykker på   og slipper mens femte tall blinker, vil måleren kort vise "DONE" og deretter returnere til målingsmodus og vise "CUSTM" sammen med tallverdier som viser at funksjonen er i bruk.







Brukeren kan eventuelt avslutte på dette tidspunktet før Enter-tasten trykkes med  . Hvis brukeren går ut av menyen med en   før han fullfører trinn 2, eller hvis det forekommer et tidsutløp, vil alt som brukeren har tastet inn bli tapt

Merk: Stolpediagrammet bruker fabrikkinnstillingene når egendefinerte enheter benyttes.

Merk: Størrelsen på angitt verdi ved bruk av egendefinerte enheter, kan i vesentlig grad øke støyen på displayet. Dette kan innvirke på funksjonene null og tara, samt på stabiliteten til vist trykkverdi. Om nødvendig bør du kontakte fabrikkens om begrensningene for inndata i fullskala.

Maksimum / Minimum:

Viser maksimum / minimum trykkverdier. Dette startes når enheten slås på eller når verdiene er slettet.







1. I menymodus, trykk på ,  for å bla til "Max" (maksimum visning). Dette indikeres i liten skrift til venstre for displayets måleenhet.
2. For å slette *både* min. og maks. verdier, trykk og hold  for å slette.
3. Når du slipper denne tasten vil du gå til menymodus. Bruk ,  for å fortsette å bla gjennom menyvalgene, ELLER hold  for å returnere til målingsmodus.

Merk: Å slette minimum/maksimum-verdier vil føre til et blankt display, bortsett fra tilhørende Min./Max.-ikon og batteriindikator.

Merk: Følgende handlinger vil også slette min/maks-verdiene. Strøm av, nullfunksjonen, tarafunksjonen, feltkalibrering, enhetsprogrammering, oppdateringshastighet eller tilbakestilling.

Teller:

Kontrollerer hvor lenge måleren skal stå PÅ etter at strømtasten  trykkes.





1. I menymodus, trykk på ,  for å bla til "TIMER" vises.
2. Trykk på  for å starte.
3. Trykk deretter på ,  for å bla gjennom verdiene. "NONE" indikerer at måleren vil stå PÅ til strømtasten  trykkes en gang til. Enhver annen verdi (1 min [standard] / 5 min / 20 min) enn "NONE" vil indikere hvor lenge denne funksjonen vil være aktivert.
4. Trykk på  for å velge ønsket verdi. Tidsikonet vil vises på displayet og enheten vil vise "DONE" og deretter returnere til målingsmodus.

Funksjon: Telleikonet vil blinke i 10 sekunder før måleren slås av. Når måleren er på, vil ethvert tastetrykk tilbakestille måleren.



Lys:

Bestemmer hvor lenge bakgrunnslyset vil være PÅ etter at enhver tast trykkes i målings- eller menymodus. (Merk: Telleren tilbakestilles med ethvert tastetrykk.)







1. I menymodus, trykk på ,  til "LIGHT" vises.
2. Trykk på  for at tellerverdien skal vises. "ON" betyr at bakgrunnslyset skal være på hele tiden til det slås "OFF", "PRESS" at baklyset slås på/av med et kort trykk på  mens "OFF" betyr at bakgrunnslyset aldri vil tennes. Valg av tidsverdier, "1 MIN" (standard), "5 MIN", "20 MIN" vil aktivere bakgrunnslyssymbolet på LCD-skjermen i det indikerte antallet minutter.
3. Trykk på  for å velge bakgrunnslysets tid (displayet vil kort vise "DONE") og returnerer til målingsmodus.

Merk: I "PRESS"-modus har fabrikken satt en 1 times teller for å spare batteriet.

Funksjon: Indikatoren for bakgrunnslyset vil blinke i 10 sekunder før lyset slås av.

Oppdatering:

Brukes til å velge hyppigheten av oppdatering av trykkverdien på skjermen. Denne funksjonen brukes når raske trykkendringer forårsaker "flimring" i de viste verdiene. Lengre intervaller vil redusere oppdateringshyppigheten og utjevne avleste verdier i slike installasjoner.







1. I menymodus, trykk på ,  til "UPDAT" vises
2. Trykk på  for å velge.
3. Trykk på ,  for å velge verdiene "1 SEC" (standard), "500 MSEC" eller "250 MSEC".
4. Trykk på  for å bekrefte verdien (displayet vil kort vise "DONE" og returnere til målingsmodus).

Merk: Hvis du endrer verdien til noe annet enn 1 sek, kan det skape et lite nullavvik og du anbefales å ventilere måleren fullstendig og nullstiller den igjen før du kan få nøyaktige avlesninger. Batteriets levetid vil også bli redusert med et oppdateringsintervall på under 1 SEC.



Z-Lock:

Brukes til å hindre en utilsiktet ny nullstilling av måleren..











1. I menymodus, trykk på ,  → til "ZLOCK" vises.
2. Trykk på  → for å velge.
3. Trykk på ,  → for å velge "L ON" eller "L OFF" (standard).
4. Trykk på  → for å bekrefte verdien (displayet vil kort vise "DONE" og returnere til målingsmodus).

Merk: Hvis Z-Lock aktiveres vil måleren vise "ZLOCK" hvis en nullstilling forsøkes.





Rekalibrering:

Gir brukeren muligheten til å kalibrere produktet der det er installert. Opprinnelig fabrikkkalibrering ligger permanent i minnet og kan kalles opp igjen når som helst.

1. I menymodus, trykk på ,  → til "RECAL" vises. og trykk deretter på  →.
2. Displayet vil indikere "FACT" (fabrikk) "FIELD" eller "NEW". Trykk på ,  → for å bla.
3. Et trykk på  → mens "FACT" (fabrikk) vises, vil gjenopprette verdien fra fabrikkkalibreringen.
4. Et trykk på  → mens "FIELD" vises, vil gjenopprette verdien fra siste feltkalibrering.
5. Et trykk på "Enter"  → mens "NEW" vises, vil åpne recalibreringsmodus.
6. Når "NEW" vises, trykk på  → ; Når du slipper, vil displayet blinke "OK/ APPLY/ REF/ PSI/ THEN/ PRESS/ ENTER/ TO/ START/ OR/ OTHER/ TO/ ABORT" (OK/ BRUK/ REF/ PSI/ DERETTER/ TRYKK/ ENTER/ FOR Å/ STARTE/ ELLER/ ANNET/ FOR Å/ AVBRYTE). Det numeriske displayet vil vise 0000. Ventiler sensoren til atmosfærisk trykk, trykk på  →. Displayet vil vise "WAIT" og telle ned fra 6 sekunder, deretter vises kort "CAL" og så går enheten automatisk til neste trinn.
7. Displayet blinker "APPLY/ REF/ PSI/ THEN/ PRESS/ ENTER/ TO/ START/ OR/ OTHER/ TO/ ABORT" (BRUK/ REF/ PSI/ DERETTER/ TRYKK/ ENTER/ FOR Å/ STARTE/ ELLER/ ANNET/ FOR Å/ AVBRYTE). Sett på fullt skala trykk i psi, slik det indikeres på målerens numeriske

display. Trykk på  . Displayet vil vise "WAIT" og telle ned fra 6 sekunder, deretter vises kort CAL, og så går enheten automatisk til neste trinn.















8. Displayet blinker "APPLY/ REF/ PSI/ THEN/ PRESS/ ENTER/ TO/ START/ OR/ OTHER/ TO/ ABORT" (BRUK/ REF/ PSI/ DERETTER/ TRYKK/ ENTER/ FOR Å/ STARTE/ ELLER/ ANNET/ FOR Å/ AVBRYTE). Sett på trykket som indikeres på det numeriske displayet og trykk på  . Displayet vil vise "WAIT" og teller ned fra 6 sekunder for så å vise GOOD. Deretter går enheten til målingsmodus.

Merk: Rekalibrering tillates kun dersom testparameterne er innenfor $\pm 7\%$. Hvis de er utenfor disse grensene, vil displayet vise "CAL FAIL / INPUT PRES TOO LOW (HIGH) / PRESS ENTER TO RETRY / PRESS OTHER TO ABORT" (kalibrering mislyktes, inngangstrykk for lavt (høyt, trykk Enter for å prøve igjen eller annet for å avbryte).







Merk: "Valget "FIELD" vises kun dersom måleren har bli korrekt recalibrert i installasjonen.







Diagram:

Gir brukeren muligheten til å endre trykkverdiene ved å bestemme minimums-/maksimumsindikasjoner over stolpediagrammet med 20 segmenter.

1. I menymodus, trykk på   , til "GRAPH" vises. og trykk deretter på  .
2. Displayet vil indikere "CGOFF" (egendefinert diagram av) [standard], "CG ON" (egendefinert diagram på) eller "NEWCG" (nytt egendefinert diagram). Trykk på    for å bla.
3. For å gjenvinne det siste angitte egendefinerte diagrammet når "CG ON" vises, trykk på  . Displayet vil kort vise "DONE" og returnere til målingsmodus.
4. For å stille stolpediagrammet tilbake til fullt skalaområde når "CGOFF" vises, trykk på  . Displayet vil kort vise "DONE" og returnere til målingsmodus.
5. For å legge inn et nytt egendefinert diagram når "NEWCG" vises, trykk på  .



6. For å programmere minimum diagramprosent, vil displayet indikere 0 0 med det høyre tallet blinkende, det aller nederst segmentet av stolpediagrammet vil blinke og displayet vil vise "PCTFS" (prosent av full skala). Trykk på ,  for å bla til et tall mellom 0-9. Trykk på  for å velge dette tallet. Venstre tall vil nå begynne å blinke. Trykk på ,  for å bla til et tall mellom 0-9. Trykk på  for å velge dette tallet. Det tosfrede tallet som ble lagt inn representerer prosenten av full skala som skal brukes som den nederste delen av diagrammet (0-99 %).

7. For å programmere maksimum prosent av full skala, vil displayet indikere 1 0 0 med det høyre tallet blinkende, det aller øverste segmentet av stolpediagrammet vil blinke og displayet vil vise "PCTFS" (prosent av full skala). Trykk på ,  for å bla til et tall mellom 0-9. Trykk på  for å velge dette tallet. Venstre tall vil nå begynne å blinke. Trykk på ,  for å bla til et tall mellom 0-10. Trykk på  for å velge dette tallet. Tallet som ble lagt inn representerer prosenten av full skala som skal brukes som den øverste delen av diagrammet. Merk: 100 er det høyeste og eneste mulige tresifrede tallet. Hvis det lave tallet er større eller likt det høye tallet, vil enheten blinke "REJECT" og vil gå tilbake til undermenyen "GRAPH".

Merk: Displaymeldingen "ULOCK" indikerer at egendefinerte enheter brukes og at stolpediagrammets minimum og maksimum er satt til fabrikkstandardene.

Tilbakestill:

Returnerer produktet til standard fabrikkverdier. Opprettholder feltkalibreringen. Fabrikkkalibrering kan gjenopprettes i menyen "RECAL".

I menymodus, trykk på ,  for å gå til "RESET" som vises på displayets nederste linje. Trykk på  for å velge dette tallet.

Fabrikkstandardene gjelder enheter, teller, bakgrunnslys, oppdateringsintervall, nullstillingslås.

Displayet vil indikere "DONE" og måleren vil gå til "OFF"-tilstand.



6.0 BATTERISKIFTE

Måleren får strøm fra to 1,5 V AA alkaliske batterier. Med normal bruk vil batteriene vare i ca. 2 000 timer før de må skiftes. Faktisk batterilevetid vil avhenge målerens bruk, den omliggende temperaturen og andre faktorer.

Skift batteriene som beskrevet i følgende fremgangsmåte:

1. Skyv den beskyttende skoen (vises ikke) av målerhuset.
2. Grip dekslet med den riflede baksiden og dreier mot klokken til "opplåsningsikonet" er på høyde med pilen - denne er på huset på bunnen av trykkoblingen (se visning A).
3. Fjern dekslet ved å trekke rett tilbake, og skift de to AA alkaliske batteriene. Påse at batteriene settes i med polene rett vei (se visning B).
4. For å sette på dekslet igjen, stiller du "opplåsningsikonet" på høyde med pilen, skyver dekslet rett inn og dreier det med klokken til pilen er på høyde med "låseikonet" (se visning C).
5. Skyv den beskyttende skoen (vises ikke) på målerhuset igjen.

Merk: Når det bakre dekslet settes på igjen kan måleren vise et negativt trykk. Dette er et midlertidig problem fordi trykket i huset vil bli avlastet gjennom husets ventil og vil bli utlignet med det atmosfæriske trykket (90 % av avviket vil utlignes innen 1 minutt, de resterende 10 % kan ta opptil 5 minutter).

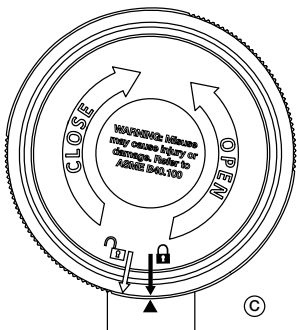
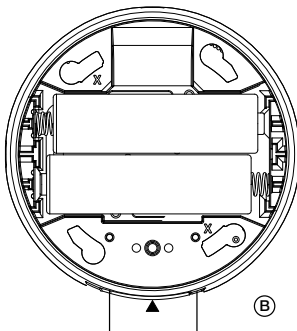
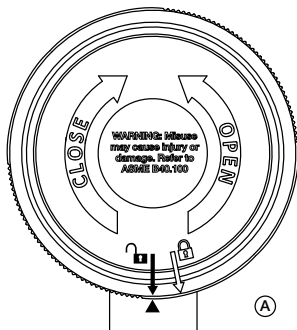

7.0 TEKNISKE DATA - MODELL DGR-2 DIGITAL TRYKKMÅLER

Dimensjoner:

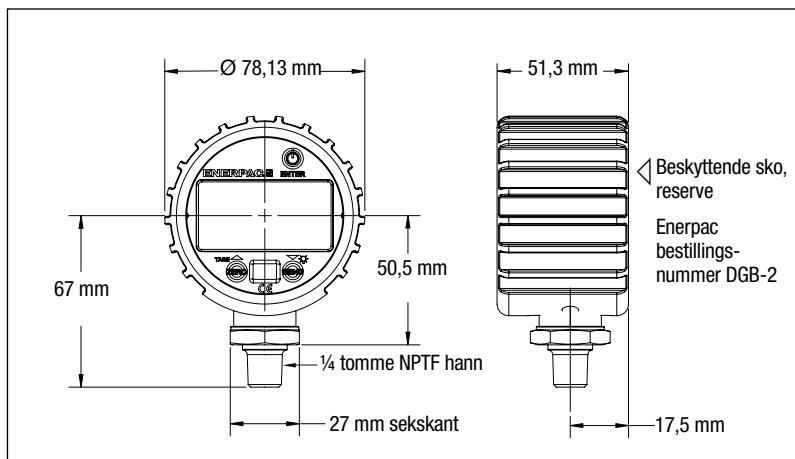

Spesifikasjoner:

Maksimal trykkgrense:				Nøyaktighet	Oppdateringsintervall	Nødvendig strøm	Vekt		Hydrauliske tilkoplinger	Husets klassifisering
psi	bar	mPa	kg/cm ²				lbs	kg		
20000	1380	140	1400	0,25%	250ms 500ms 1s (brukervalgbar)	3 V DC (to AA alkaliske batterier)	0,5	0,23	¼ tomme NPTF hann	IP67
⚠ ADVARSEL: Overskrid aldri maksimum trykkgrense.										

Miljøspesifikasjoner	
	Akseptabelt område
Omliggende brukstemperatur	-20°C til 60°C
Temperatur, hydraulikkolje	-20°C til 80°C
Oppbevaringstemperatur (batterier installert)	-20°C til 60°C
Oppbevaringstemperatur (batterier fjernet)	-20°C til 80°C
Temperaturkoeffisient	0,04 %/°F [-20 °C til 180 °C] null og variasjonsbredde, referansetemperatur 70 °F

Informasjon om område og intervaller		
Valgt måleenhet	Område	Intervall
psi	0-20000	1
bar	0-1380	0.1
mPa	0-140	0.01
kg/cm ²	0-1400	0.1

Offisielle godkjenninger
CE EN 61326 (1998) CE EN 61326 Vedlegg A (tungindustri) UL/cUL-61010-1 (avventer) I samsvar med RoHS

CE Denne enheten oppfyller kravene til CE-merking.

L4009 Rev. A 01/13

1.0 VIKTIGA MOTTAGNINGSinSTRUKTIONER

Kontrollera att inga komponenter skadats under transport. Transportskador täcks inte av garantin. Om du upptäcker transportskador ska du genast meddela transportföretaget. Transportföretaget är ansvarigt för alla reparations- och utbyteskostnader som härrör sig från skada under transporten.

SÄKERHETEN FRÄMST

2.0 SÄKERHETSFRÅGOR



Läs noggrant igenom alla instruktioner, varningar och försiktighetsåtgärder. Följ alla säkerhetsåtgärder för att undvika personskador eller skador på egendom under systemdrift. Enerpac kan inte hållas ansvarigt för materialskada eller personskada som uppstår som följd av användning av produkten på osäkert sätt, brist på underhåll eller felaktig användning av produkt och/eller system. Kontakta Enerpac när du är osäker på säkerhetsåtgärder och funktioner. Om du aldrig utbildats på säkerhet rörande högtryckshydraulik, ska du kontakta ditt distributions- eller servicecenter om en gratis säkerhetskurs för Enerpac-hydraulik.

Att inte följa de följande försiktighetsuppmaningarna och varningarna kan orsaka materialskada och personskada.

VAR FÖRSIKTIG! uppmärksammar dig på korrekta drifts- och underhållsprocedurer för att förhindra skador på utrustning eller annan egendom.

VARNING! indikerar en möjlig fara som kräver korrekta procedurer och rätt användning för att undvika personskador.

FARA! visas bara när dina handlingar eller icke utförda handlingar kan orsaka allvarliga skador eller till och med dödsfall.



VARNING! Ta på dig lämplig personlig skyddsutrustning när du använder hydraulisk utrustning.



VARNING! Håll dig på avstånd från laster som stöds av hydrauliken. När en cylinder används som lastlyftanordning ska den aldrig användas som anordning för att hålla lasten. När lasten höjts eller sänkts måste den alltid blockeras mekaniskt.



VARNING! ANVÄND ENDAST FASTA STYCKEN FÖR ATT HÅLLA LASTER. Välj noggrant ut block av stål eller trä som klarar av att stötta lasten. Använd aldrig en hydraulcylinder som mellanlägg eller förlängning i lyft- eller trycktillämpning.



FARA! Håll händer och fötter borta från cylinder och arbetsyta vid drift för att undvika personskador.



VARNING! Överskrid inte utrustningens klassificering. Försök aldrig lyfta en last som väger mer än cylinderns kapacitet. Överbelastning orsakar fel på utrustning och eventuell personskada. Cylinderna är utformade för ett max. tryck på 700 bar [10 000 psi]. Anslut inte en domkraft eller en cylinder till en pump med högre tryckklassificering.



STÅLL aldrig in säkerhetsventilen på ett högre tryck än det maximala nominella trycket för pumpen. Högre inställningar kan resultera i skada på utrustning och/eller personskada.



VARNING! Systemets arbetstryck får inte överstiga tryckklassificeringen för den lägst klassificerade komponenten i systemet. Installera manometrar i systemet för att övervaka driftstrycket. Med dem kan du se vad som händer i systemet.



VAR FÖRSIKTIG! Undvik att skada hydrauliska slangar. Undvik tvära böjar och veck när du drar hydraulslangarna. Användning av en böjd eller veckad slang kommer att orsaka allvarligt mottryck. Tvära böjar och veck kommer att skada slangens internt, vilket leder till fel på slangerna i förtid.



Tappa inte tunga föremål på slangerna. Ett starkt slag kan orsaka inre skada på slangens armering. Att applicera tryck på en skadad slang kan göra att den går sönder.



VIKTIGT! Lyft inte hydraulisk utrustning i slangarna eller snabbkopplingarna. Använd bärhandtaget eller andra säkra transportmedel.



VAR FÖRSIKTIG! Håll hydraulisk utrustning borta från lågor och värme. För mycket hetta mjukar upp packningar och tätningar, vilket resulterar i vätskeläckage. Värme försvagar också slangmaterial och -packningar. Utsätt inte utrustningen för temperaturer på 65 °C (150 °F) eller högre för en optimal prestanda. Skydda slangar och cylindrar från svetsstänk.



FARA! Ta inte i trycksatta slangar. Olja som sprutar ut under tryck kan tränga igenom huden och orsaka allvarlig skada. Om olja tränger in under huden måste läkare uppsökas omedelbart.



VARNING! Använd hydrauliska cylindrar bara i ett kopplat system. Använd aldrig en cylinder med icke anslutna kopplingar. Om cylindern blir extremt överbelastad, kan komponenterna ge efter katastrofalt och orsaka allvarlig personskada.



VARNING! SÄKERSTÄLL ATT UPPSTÄLLNINGEN ÄR STABIL INNAN DU LYFTER LAST. Cylindrar skall placeras på en plan yta som kan bära lasten. Använd en cylinderbas för ökad stabilitet när så är tillämpligt. Svetsa inte eller på annat sätt modifiera cylindern för att fästa en bas eller annat stöd.



Undvik situationer där laster inte är direkt centrerade på cylinderns kolv. Ocentrerade laster belastar cylindrarna och kolvarna avsevärt. Dessutom kan lasten glida eller falla vilket kan få farliga resultat. Fördela lasten jämnt över hela sadelytan. Använd alltid en sadel för att skydda kolven.



Fördela lasten jämnt över hela sadelytan. Använd alltid sadeln för att skydda kolven.



VIKTIGT! Hydraulisk utrustning får endast servas av en behörig hydraultekniker. Kontakta ett behörigt ENERPAC servicecenter i ditt område vid behov av reparationer. Använd bara ENERPAC-olja för att skydda din garanti.



VARNING! Byt direkt ut utslitna eller skadade delar med äkta ENERPAC-delar. Delar av vanligt material kan gå sönder och orsaka skador på person och egendom. ENERPAC-delar är tillverkade för att passa perfekt och motstå höga laster.

3.0 BESKRIVNING

Enerpacs DGR-2 digitala manometer är utformad för att övervaka systemtryck upp till 1 380 bar [20 000 psi]. Standardfunktioner inkluderar:

- Skärmar finns för flera enheter: psi, bar, mPa and kg/cm² (väljs av användaren).
- Nollställningsfunktionen säkerställer att manometern alltid visar verkligt systemtryck.
- Drivs av två 1,5 V AA batterier (medföljer).
- Höljet utformat per IP67.
- Timer som användaren ställer in stänger av manometern.
- Uppfyller CE och RoHS.

Obs! Se avsnitt 7.0 i denna bruksanvisning för detaljerade produktspecifikationer och installationsmått.

4.0 INFORMATION OM INSTALLATION

VIKTIGT! För att säkerställa korrekt funktion och för att förhindra att manometern går sönder, läs och förstå följande instruktioner och försiktighetsåtgärder innan du installerar manometern.



WARNING! Ett haveri som resulterar i personskada och / eller skada på egendom kan orsakas av alltför högt övertryck, kraftiga vibrationer eller tryckpulser, för hög instrumenttemperatur, korrosion på trycksatta delar eller annat missbruk. Rådfråga Enerpac innan du installerar manometern om det finns några frågor eller bekymmer.

Övertryck:

Tryckstötter som överstiger manometerens nominella tryck kan orsaka oönskade elektriska och / eller mekaniska skador på trycksatta mätelmen. Tryckstötter och -rus kan förstöra tryckgivare och måste alltid undvikas. En tryckdämpare bör installeras för att eliminera den skadliga effekten av tryckstötter. Tryckstötter uppstår när ett vätskeflöde plötsligt stoppas, t.ex. vid snabb stängning av solenoidventiler. Rus uppstår när flödet plötsligt börjar, t.ex. när en pump slås på med full effekt eller en ventil öppnas snabbt.



WARNING: Manometern är klassificerad för 1 380 bar [20 000 psi] maximum tryck. Överskrid aldrig denna maximala tryckklassificering.

Tryckrus:

Rus är särskilt skadliga för manometrar om röret är tomt från början. För att undvika tryckrus ska vätskeledningar hållas fyllda (om det går), pumpar bör startas långsamt och ventiler öppnas långsamt. För att undvika skada från både tryckstötter och -rus bör en utjämningskammare installeras. Symtom på de skadliga effekterna av tryckstötter och -rus:

- Den digitala manometern visar stor nollpunktsförskjutning.
- Den digitala manometerens tryckvisning förblir konstant oavsett tryck.
- Felkod visas på skärmen.

Kalla temperaturer:

Isbildning i manometerens tryckport kan orsaka permanenta skador på manometern. När så är möjligt, montera manometern in upprätt vertikalt läge för att förhindra eventuell skada av övertryck p.g.a. frysnings.

Obs! Kontrollera hela hydraulsystemet beträffande läckor om man misstänker att vatten har kommit in i systemet. Gör nödvändiga reparationer innan systemet sätts i drift igen.

Installationskrav:







En 27 mm [1-1/16 tum] U-nyckel krävs för att dra åt manometern till den hydrauliska anslutningen. Applicera teflonband eller en lämplig tätningsmassa till 1/4 tum NPTF-gångorna på manometern. Använd nyckeln till att dra 1 varv hårdare än för hand eller tills en tät förslutning har uppnåtts.



VAR FÖRSIKTIG! Att dra åt manometern genom att gripa eller sätta ett verktyg på plasthöljet kan orsaka permanenta skador på den.

5.0 DRIFTANVISNINGAR

Tangenter:

- ① På-Av / Enter 
- ② Noll / Upppil / Tarera  ▲ Tarera
- ③ Menyval / Ned / Bakljuspil  ▲ 
- ④ Tangenttryck är **kort**  mindre än 0,5 sekunder, eller **lång**   – längre än 0,5 sekunder



LCD-skärm och funktioner:

- ① 5 siffror visar tryck.
- ② Stapeldiagram med 20 segment visar tryckområde - varje segment motsvarar 5 % av området.
- ③ Timer-symboler för sömn- och bakgrundsbelysning.
- ④ Ikoner för maximum/minimum tryck och tarering.
- ⑤ Skärm med 5 alfanumeriska tecken.
- ⑥ Batteriindikator med 4 segment.
- ⑦ Indikator för negativt tryck.

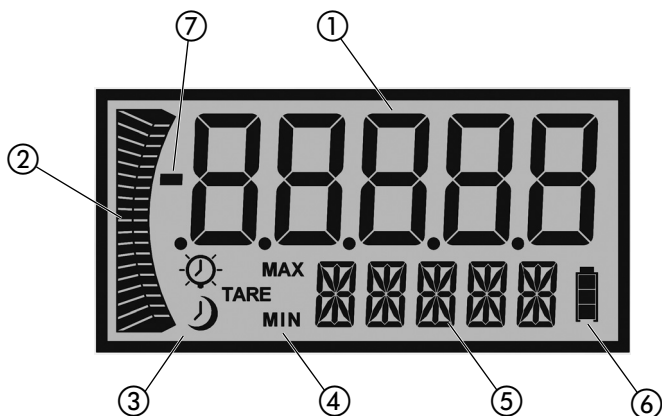

Obs! Tangenttryckningar som betecknas som korta (mindre än 0,5 sek) indikeras med ikonen "↶" .

Tangenttryckningar som betecknas som långa (längre än 0,5 sek) indikeras med ikonen "↷" .

Slå PÅ/AV manometern

Tryck på tangenten  ↷ för att slå PÅ/AV manometern. När den slås på visar skärmen kortvarigt alla LCD-segment tända, produktversion och fullt skalområde; sedan fortsätter enheten automatiskt till mätläget.

Nollfunktion:

Tryck på  ↷ . När du släpper försvinner siffrorna tillfälligt och "NOLL" visas på den alfanumeriska skärmen. Sedan återvänder manometern till mätläget. Trycket ska nu visa 0. Nollvärdet lagras i minnet.

Obs! Ett skärmeddelande "RLOCK" indikerar att noll är mer än $\pm 5\%$ från fabrikskalibreringen. Det går inte att nollställa.

Obs! Ett meddelande "ZLOCK" indikerar att nollåsfunktionen är aktiverad.



Tareringsfunktion:

Subtraherar aktuellt tryckvärde från värdet som visas in mätläge.

I mätläget, applicera önskat tryck och tryck på **ZERO** för att aktivera tareringsfunktionen. Skärmen kommer snabbt att blinka "TARE". Sedan visas ikonen "TARE" och tryckavläsningen blinkar. Enheten ska nu visa 0. Tryck på **ZERO** en gång till för att avaktivera tareringsfunktionen. Skärmen kommer snabbt att blinka "T OFF". Sedan försvinner ikonen "TARE" och tryckavläsningen blinkar inte längre. Enheten återvänder nu till mätläget.



Programmering:

Öppna Menyläge

1. Tryck på **menu** och släpp för att fortsätta till programmeringsläge.
2. Tryck på **▲**, **▼**, för att rulla genom programmerbara menyalternativ.
3. När önskat alternativ uppnås, tryck på **⏻** för att öppna denna parameter.
4. Om du vill avsluta (Avbryta) menyläget (eller undermenyläget) håll ned **menu**. Ditt arbete sparas inte.

Programmerbara parametrar:

Måttenheter:



1. I menyläget, tryck på **▲**, **▼**, för att rulla till "UNITS" (Enheter), och tryck på **⏻**.
2. Välj tekniska enheter genom att rulla **▲**, **▼**, tills önskad enhet visas, "PSI, BAR, kg/cm, mPa, kunddefinierade enheter (CUSTM)".
3. Tryck på **⏻** för att välja enheter och återvända till mätläget.

Obs! För programmering av egna enheter, se sidan 135.



Egna måttenheter:

Här kan en användare definiera en egen måttenhet. Avändaren måste ange fullt skalvärde för önskad avläsning. Så här gör man.



1. I menyläget, tryck på ,  → , välj "CUSTM", och tryck på  → .
2. Välj placering av decimalpunkten:



Den alfanumeriska skärmen ska visa "SELDP".



Den första skärmen som visas visar alla siffror tända som "5" och längst till höger blinkar decimalpunkten (5 5 5 5.5) om inte anpassade enheter har använts tidigare. Om de har använts tidigare skall siffrorna och decimalpunktens läge motsvara de senast inställda värdena. Använd tangenterna ,  → till att flytta decimalpunkten åt vänster eller höger. När decimalpunkten står i önskat läge, tryck på  → för att låsa den på plats. När tangenten släpps visar skärmen "DIGITAL".

3. Välj fullt skalvärde:

Den alfanumeriska skärmen ska visa "DIGIT".

Nästa skärm kommer att fortsätta att visa alla siffror som "5", med siffran längst till vänster blinkande och decimalpunkten fast i det tidigare valda läget. Men om den egna enheten har använts tidigare, ska siffrorna motsvara det senaste värdet. Decimalpunkten förblir i det läge som valdes i steg 1. Tryck på ,  → om du vill ändra siffrans värde mellan 0-9.

När önskat värde visas, tryck på knappen  → för att låsa det på plats. Nu blinkar nästa siffra åt höger. Upprepa detta förfarande för alla 5 siffrorna. När du trycker på och släpper  → med den femte siffran blinkande, visar manometern kort "DONE" och återvänder sedan till mätläget och visar "CUSTM" med den numeriska avläsningen för att visa att funktionen används.











Användaren kan alternativt välja att avbryta när som helst innan knappen Enter trycks ned med  → . Om användaren avbryter menyn med att trycka på  → . innan steg 2 fullbordas, eller om menyns tid överskrids, kommer allt som användaren angav att gå förlorat.

Obs! Stapeldiagrammet använder fabriakens standardinställning när egna enheter används.

Obs! Storleken på det värde som anges när du använder funktionen egna enheter kan avsevärt öka bruset på skärmen, vilket kan påverka funktionerna noll och tarering samt stabiliteten hos den tryckavläsning som visas. Om det behövs, rådfråga fabriken beträffande rekommenderade begränsningar vid angivande av full skala.

Maximum / Minimum:

Visar maximum och minimum tryck; detta initieras när enheten slås på eller när värden har raderats.











1. I menyläget, tryck på ,   för att rulla till "Max" (max visning); Detta indikeras med små tecken till vänster om skärmens måttenhet.
2. Om du vill radera *både* Min. och Max. värden, tryck på och håll ned  .
3. Om du släpper denna tangent stannar du i menyläget. Använd ,   till att fortsätta att rulla genom menyalternativen, ELLER tryck på och håll ned   för att återvända till mätläget.

Obs! Om du raderar min/max-värden får du en tom skärm med undantag för den associerade min/max-ikonen och batteriindikator.

Obs! Följande åtgärder raderar också min/max-värden. Stäng av, nollställningsfunktion, tareringsfunktion, fältkalibreringsfunktion, programmering av enheter, uppdateringshastighet eller återställning.

Timer:

Reglerar hur länge manometern förblir På du trycker på knappen Kraft .





1. I menyläget, tryck på ,   för att rulla tills "TIMER" visas.
2. Tryck på  .
3. Och tryck sedan på ,   för att rulla genom värden. "NONE" (INGEN) betyder att manometern förblir På tills knappen Kraft  trycks ned en andra gång. Något annat värde (1 min [standard] / 5 min / 20 min), annat än "NONE", kommer att bestämma hur lång tid denna funktion kommer att gålla.
4. Tryck på   för att välja önskat värde; timer-ikonen visas på skärmen och enheten kommer att visa "DONE" (KLAR) och sedan återgå till mätläget.

Funktion: Timer-ikonen blinkar i 10 sekunder innan manometern slås av. Medan manometern är på kommer ett tryck på valfri knapp att återställa timern.



Ljus:

Bestämmer hur länge bakgrundsbelysningen ska vara på när någon tangent trycks in i lägena Mätning eller Meny (Obs! Timern återställs när du trycker på valfri knapp.)







1. I menyläget, tryck på ,  \rightarrow tills "LIGHT" visas.
2. Tryck på  \rightarrow för att visa timerns värde; "PÅ" syftar på att bakgrundsbelysningen förblir PÅ hela tiden när enheten är PÅ. "PRESS" betyder att bakgrundsbelysningen slås på / av när man trycker kort på knappen bakgrundsbelysning  \rightarrow medan "OFF" indikerar att bakgrundsbelysningen aldrig slås på. Om du väljer tidsvärden, "1 MIN" (standard), "5 MIN", "20 MIN", aktiveras bakgrundsbelysningens symbol på LCD-skärmen för de minuter som bestämts.
3. Tryck på  \rightarrow för att välja tid för bakgrundsbelysning (skärmen visar kort "DONE") och återvända till mätläget.

Obs! I läget "PRESS" har fabriken ställt in timern på 1 timma för att spara batteriet.

Funktion: Bakgrundsbelysningens indikator blinkar i 10 sekunder innan ljuset slås från.

Uppdatera:

Används för att välja hur ofta det visade tryckvärdet uppdateras på skärmen. Denna funktion används när snabba tryckändringar orsakar "fladder" i visade värden; längre intervall minskar uppdateringshastigheten och "jämnar ut" avläsningen vid sådana tillämpningar.





1. I menyläget, tryck på ,  \rightarrow tills "UPDAT" visas.
2. Tryck på  \rightarrow för att välja.
3. Tryck på ,  \rightarrow för att välja värden för "1 SEC" (standard), "500 MSEC", eller "250 MSEC".
4. Tryck på  \rightarrow för att välja värdet (skärmen visar kort "DONE") och återvänder till mätläget.

Obs! Att ändra värdet till något annat än en sekund kan orsaka en lätt nollpunktsförflyttning, och det rekommenderas att mätaren avluftas helt och nollställs igen innan korrekta avläsningar görs. Dessutom kommer batteriets livslängd att minskas genom användning av en uppdatering snabbare än 1 sek.



Z-lås:

Används för att förhindra oavsiktlig åter-nollställning av manometern.











1. I menyläget, tryck på ,  → tills "ZLOCK" visas.
2. Tryck på  → för att välja.
3. Tryck på ,  → för att välja. "L ON" eller "L OFF" (standard).
4. Tryck på  → för att välja värdet (skärmen visar kort "DONE") och återvänder till mätläget.

Obs! Om Z-lås är aktiverat visar manometern "ZLOCK" om du försöker nollställa den.



Omkalibrering:

Ger användaren möjlighet att kalibrera enheten i fältet. Den ursprungliga fabrikskalibreringen finns permanent kvar i minnet och kan återkallas när som helst.

1. I menyläget, tryck på ,  → tills "RECAL" visas; fortsätt med att trycka på  →.
2. Skärmen indikerar "FACT" (fabrik) "FIELD" eller "NEW". Tryck på ,  → för att rulla.
3. När du trycker på  → medan "FACT" (fabriken) visas, återställs fabrikskalibreringen.
4. När du trycker på  → när "FIELD" visas återställs värdet från senaste kalibrering i fältet.
5. Om du trycker på tangenten "Enter"  → när "NEW" visas öppnas omkalibreringsläget.
6. När "NEW" visas, tryck på  → ; när du släpper blinkar skärmen "OK/ APPLY/ REF/ PSI/ THEN/ PRESS/ ENTER/ TO/ START/ OR/ OTHER/ TO/ ABORT". Sifferskärmen visar .0000. Avlufta givaren till atmosfärstryck, tryck på  → skärmen visar "WAIT" och räknar ner från 6 sekunder, visar sedan kort CAL och går sedan automatiskt till nästa steg.
7. Skärmen blinkar "APPLY/ REF/ PSI/ THEN/ PRESS/ ENTER/ TO/ START/ OR/ OTHER/ TO/ ABORT"; applicera fullskalans trycki psi-enheter som indikeras på sifferskärmen på manometern. Tryck på  → skärmen visar "WAIT" och räknar ner från 6 sekunder, visar sedan kort CAL och går sedan automatiskt till nästa steg.















8. Skärmen blinkar "APPLY/ REF/ PSI/ THEN/ PRESS/ ENTER/ TO/ START/ OR/ OTHER/ TO/ ABORT"; applicera det tryck som anges i sifferskärmen på manometern och tryck på . Skärmen visar "WAIT", räknar ner från 6 sekunder visar sedan kort GOOD innan den avbryter till mätläget.

Obs! Omkalibrering är tillåten endast om testparametrar ligger inom $\pm 7\%$. Om utanför denna gräns indikerar skärmen "CAL FAIL / INPUT PRES TOO LOW (HIGH) / PRESS ENTER TO RETRY / PRESS OTHER TO ABORT".







Obs! Alternativet "FIELD" visas endast om manometern framgångsrikt har blivit omkalibrerad i fältet.







Diagram:

Ger användaren möjlighet att modifiera tryckvärden som bestämmer minimum / maximum indikationerna för stapeldiagrammet med 20 segment.

1. I menyläget, tryck på ,  , tills "GRAPH" visas; tryck på  .
2. Skärmen indikerar "CGOFF" (eget diagram från) [standard], "CG ON" (eget diagram på), eller "NEWCG" (nytt eget diagram). Tryck på ,   för att rulla.
3. Om du vill återkalla det senaste egna diagrammet som angavs när "CG ON" visas, tryck på  . Skärmen visar kort "DONE" och återvänder till mätläget.
4. Återställa stapeldiagram till fullt skalområde; när "CGOFF" visas, tryck på  . Skärmen visar kort "DONE" och återvänder till mätläget.
5. Ange ett nytt eget stapeldiagram; när "NEWCG" visas, tryck på  .



6. För att programmera lägsta diagramprocent indikerar skärmen 0 0 med höger siffra blinkande, det nedersta segmentet av stapeldiagrammet blinkar och skärmen visar "PCTFS" (procent full skala). Tryck på ,  för att rulla till ett tal 0-9. Tryck på  för att välja det talet. Den vänstra siffran börjar nu blinka. Tryck på ,  för att rulla till ett tal 0-9. Tryck på  för att välja det talet. Det 2-siffriga talet representerar procentandelen av full skala som ska användas som den låga änden av diagrammet (0-99%).

7. För att programmera maximum procent av full skala indikerar skärmen 1 0 0 med höger siffra blinkande, det översta segmentet av stapeldiagrammet blinkar och skärmen visar "PCTFS" (procent full skala). Tryck på ,  för att rulla till ett tal 0-9. Tryck på  för att välja det talet. De två vänstra siffrorna börjar nu blinka. Tryck på ,  för att rulla till ett tal 0-10. Tryck på  för att välja det talet. Talet som anges representerar procentandelen av full skala som ska användas som den höga änden av diagrammet. Obs! 100 är det högsta och enda möjliga 3-siffriga talet. Om det låga talet är lika med eller större än det stora talet, kommer enheten att blinka "REJECT" och kommer att gå tillbaka till undermenyn "GRAPH".

Obs! Ett skärmmeddelande "ULOCK" indikerar att egna enheter används och stapeldiagrammets minimum och maximum ställs in på fabriken standardinställning.

Återställ:

Återställer produkten till fabriken standardinställningsvärden. Bevarar kalibrering i fältet. Fabrikskalibreringen kan återställas i menyn "RECAL".

I menyläget, tryck på ,  tills "RESET" visas på skärmens nedersta rad. Tryck på .

Fabriksinställningar avser enheter, timer, bakgrundsbelysning, uppdateringshastighet, nolllås.

Skärmen indikerar "DONE" och sedan byter manometern till läget "OFF".



6.0 BYTA BATTERIER

Manometern drivs av två 1,5 volts typ AA alkaliska batterier. I normal drift räcker batterierna ungefär 2 000 timmar innan de behöver bytas ut. Faktisk batteritid varierar beroende på manometers användning, omgivningens temperatur och andra faktorer.

Byt ut batterierna så här:

1. Skjut av det skyddande omslaget (visas ej) från manometers hölje.
2. Grip den räfflade baksidan och vrid den moturs tills "unlock" är i linje med pilen - den finns på huset vid basen av tryckanslutningen (se vy A).
3. Ta bort locket genom att dra rakt bakåt och byt ut de AA alkaliska batterierna; säkerställ att batterierna har rätt polaritet (se vy B).
4. För att sätta fast locket igen, rikta in ikonen "unlock" med pilen, tryck locket rakt in och vrid medurs tills pilen är i linje med ikonen "lock" (se vy C).
5. Sätt tillbaka det skyddande omslaget (visas ej) på manometers hölje.

Obs! Återinstallationen av det bakre locket kan göra att manometern visar negativt tryck. Detta är ett tillfälligt problem eftersom det interna trycket i höljet kommer att släppas av avluftningen och utjämnas mot atmosfärstryck (90 % av förskjutningen kommer utjämnas inom en minut, resterande 10 % tar upp till fem minuter).

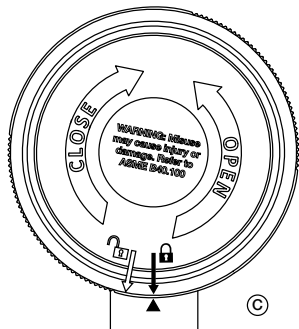
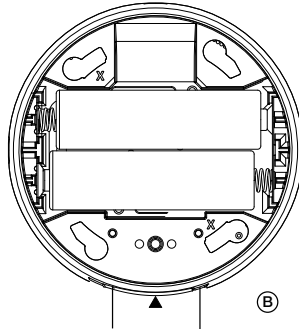
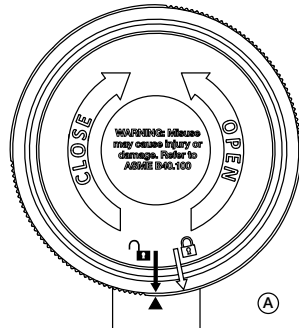

7.0 TEKNISKA DATA - MODELL DGR-2 DIGITAL MANOMETER

Mått:

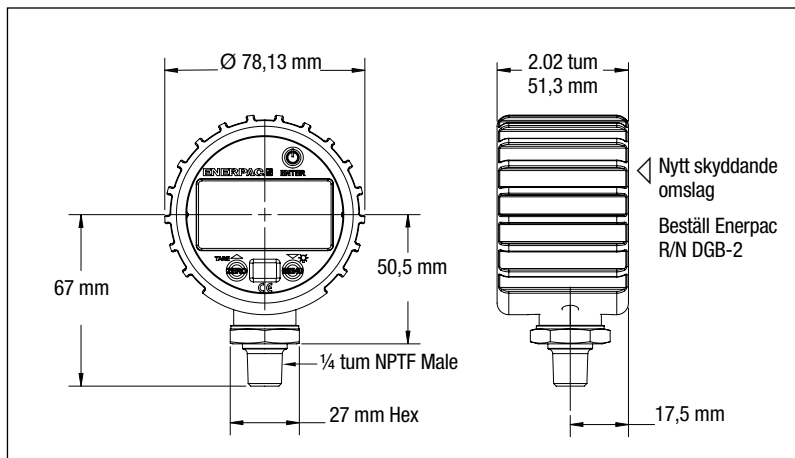

Specifikationer:

Maximum tryckklassificering:				Noggrannhet	Uppdateringshastighet	Strömkrav	Vikt		Hydraulisk anslutning	Märkdata för hölet
psi	bar	mPa	kg/cm ²				lbs	kg		
20000	1380	140	1400	0.25%	250ms 500ms 1s (väljs av användaren)	3 volt DC (två AA alkaliska batterier)	0.5	0,23	1/4 tum NPTF Male	IP67
WARNING! Överskrid aldrig maximal tryckklassificering.										

Miljöspecifikationer	
	Acceptabelt område
Arbetstemperatur, omgivningen	-20°C to 60°C
Temperatur, hydraulolja	-20°C to 80°C
Temperatur, förvaring (batterier installerade)	-20°C to 60°C
Temperatur, förvaring (batterier borttagna)	-20°C to 80°C
Temperaturkoefficient	0,04 %/ °F [-20 °C till 180 °C] noll och spann, referenstemperatur 70 °F

Godkännanden av myndigheter		
Måttenhet vald	Område	Intervall
psi	0-20000	1
bar	0-1380	0.1
mPa	0-140	0.01
kg/cm ²	0-1400	0.1

Godkännanden av myndigheter
CE EN 61326 (1998) CE EN 61326 Annex A (tung industri) UL/cUL-61010-1 (under bearbetning) Uppfyller RoHS

Denna enhet uppfyller kraven för CE-märkning.

Australia and New Zealand

Actuant Australia Ltd.
Block V Unit 3
Regents Park Estate
391 Park Road
Regents Park NSW 2143
(P.O. Box 261) Australia
T +61 (0)2 9743 8988
F +61 (0)2 9743 8648
sales-au@enerpac.com

Brazil

Power Packer do Brasil Ltda.
Rua dos Inocentes, 587
04764-050 - Sao Paulo (SP)
T +55 11 5687 2211
F +55 11 5686 5583
Toll Free: 0800 891 5770
vendasbrasil@enerpac.com

Canada

Actuant Canada Corporation
6615 Ordan Drive, Unit 14-15
Mississauga, Ontario L5T 1X2
T +1 905 564 5749
F +1 905 564 0305
Toll Free:
T +1 800 268 4987
F +1 800 461 2456
customer.service@actuant.com

China

Actuant (China) Industries Co. Ltd.
No.6 Nanjing East Road,
Taicang Economic Dep Zone
Jiangsu, China
T +86 0512 5328 7500
F +86 0512 5335 9690
Toll Free: +86 400 885 0369
sales-cn@enerpac.com

France, Switzerland, North Africa and French speaking African countries

ENERPAC
Une division d'ACTUANT France S.A.
ZA de Courtaboeuf
32, avenue de la Baltique
91140 VILLEBON /YVETTE
France
T +33 1 60 13 68 68
F +33 1 69 20 37 50
sales-fr@enerpac.com

Germany and Austria

ENERPAC GmbH
P.O. Box 300113
D-40401 Düsseldorf
Willstätterstrasse 13
D-40549 Düsseldorf, Germany
T +49 211 471 490
F +49 211 471 49 28
sales-de@enerpac.com

India

ENERPAC Hydraulics Pvt. Ltd.
No. 1A, Peenya Industrial Area
IInd Phase, Bangalore, 560 058, India
T +91 80 40 792 777
F +91 80 40 792 792
sales-in@enerpac.com

Italy

ENERPAC S.p.A.
Via Canova 4
20094 Corsico (Milano)
T +39 02 4861 111
F +39 02 4860 1288
sales-it@enerpac.com

Japan

Applied Power Japan LTD KK
Besshocho 85-7
Kita-ku, Saitama-shi 331-0821, Japan
T +81 48 662 4911
F +81 48 662 4955
sales-jp@enerpac.com

Middle East, Egypt and Libya

ENERPAC Middle East FZE
Office 423, LOB 15
P.O. Box 18004, Jebel Ali, Dubai
United Arab Emirates
T +971 (0)4 8872686
F +971 (0)4 8872687
sales-ua@enerpac.com

Russia

Rep. office Enerpac
Russian Federation
Admiral Makarova Street 8
125212 Moscow, Russia
T +7 495 98090 91
F +7 495 98090 92
sales-ru@enerpac.com

Singapore

Actuant Asia Pte Ltd.
83 Joo Koon Circle
Singapore 629109
T +65 68 63 0611
F +65 64 84 5669
Toll Free: +1800 363 7722
sales-sg@enerpac.com

South Korea

Actuant Korea Ltd.
3Ba 717, Shihwa Industrial Complex
Jungwang-Dong, Shihung-Shi,
Kyunggi-Do
Republic of Korea 429-450
T +82 31 434 4506
F +82 31 434 4507
sales-kr@enerpac.com

Spain and Portugal

ENERPAC SPAIN, S.L.
Avda. Los Frailes, 40 – Nave C & D
Pol. Ind. Los Frailes
28814 Daganzo de Arriba
(Madrid) Spain
T +34 91 884 86 06
F +34 91 884 86 11
sales-es@enerpac.com

Sweden, Denmark, Norway, Finland and Iceland

Enerpac Scandinavia AB
Fabriksgatan 7
412 50 Gothenburg
Sweden
T +46 (0) 31 799 0281
F +46 (0) 31 799 0010
scandinavianinquiries@enerpac.com

The Netherlands, Belgium, Luxembourg, Central and Eastern Europe, Baltic States, Greece, Turkey and CIS countries

ENERPAC B.V.
Galvanistraat 115
6716 AE Ede
P.O. Box 8097
6710 AB Ede
The Netherlands
T +31 318 535 911
F +31 318 535 848
sales-nl@enerpac.com

Enerpac Integrated Solutions B.V.

Opaalstraat 44
7554 TS Hengelo
P.O. Box 421
7550 AK Hengelo
The Netherlands
T +31 74 242 20 45
F +31 74 243 03 38
integratedsolutions@enerpac.com

South Africa and other English speaking African countries

Enerpac Africa Pty Ltd.
No. 5 Bauhinia Avenue
Cambridge Office Park
Block E
Highveld Techno Park
Centurion 0157
South Africa
T: +27 12 940 0656

United Kingdom and Ireland

ENERPAC Ltd.,
Bentley Road South
Darlaston, West Midlands
WS10 8LQ
England
T +44 (0)121 50 50 787
F +44 (0)121 50 50 799
sales-uk@enerpac.com

USA, Latin America and Caribbean

ENERPAC
P.O. Box 3241
Milwaukee WI 53201 USA
T +1 262 293 1600
F +1 262 293 7036
User inquiries:
T +1 800 433 2766
Distributor inquiries/orders:
T +1 800 558 0530
F +1 800 628 0490
Technical inquiries:
techservices@enerpac.com
sales-us@enerpac.com

All Enerpac products are guaranteed against defects in workmanship and materials for as long as you own them.

For the location of your nearest authorized Enerpac Service Center, visit us at www.enerpac.com