

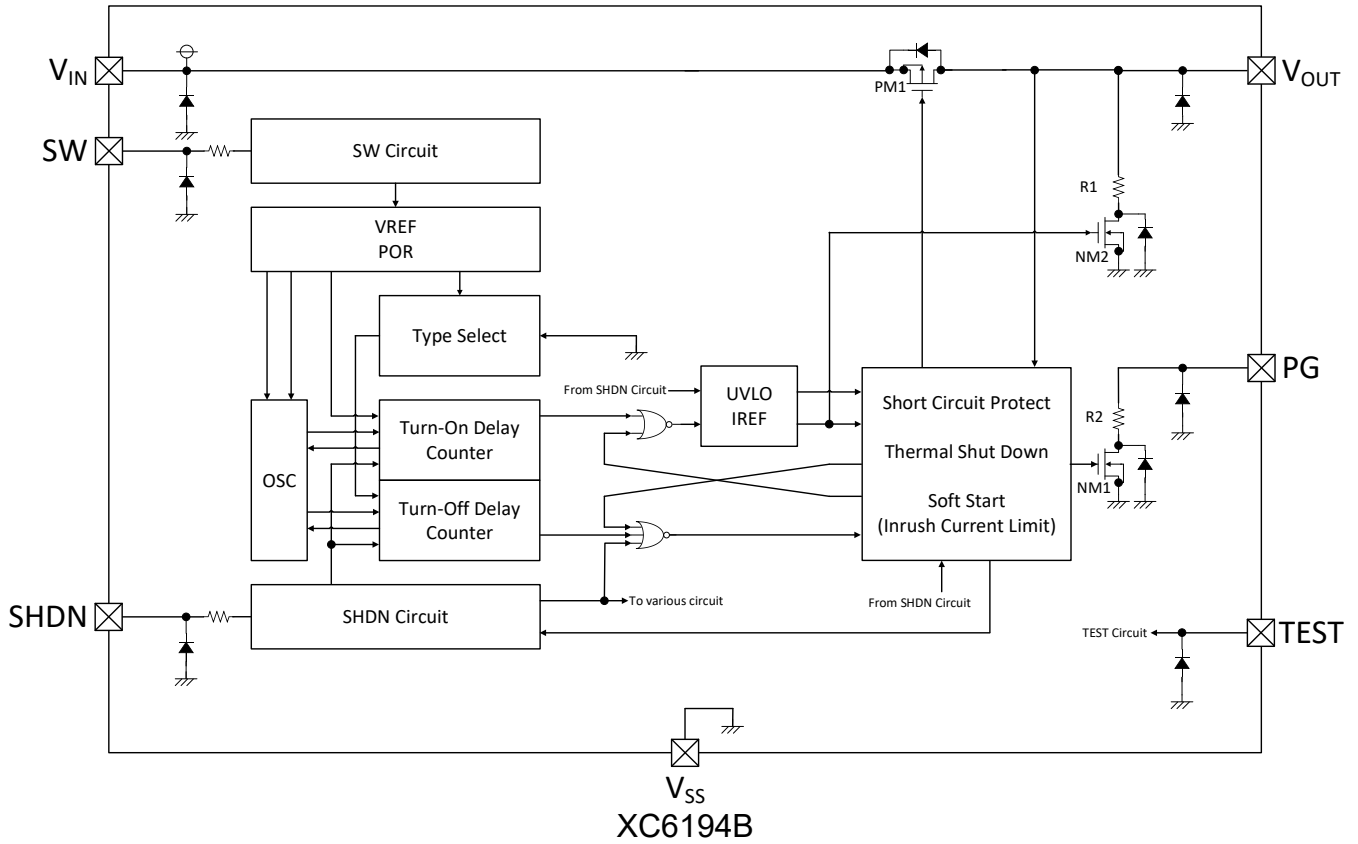

## ■ BLOCK DIAGRAM

XC6194A



XC6194B

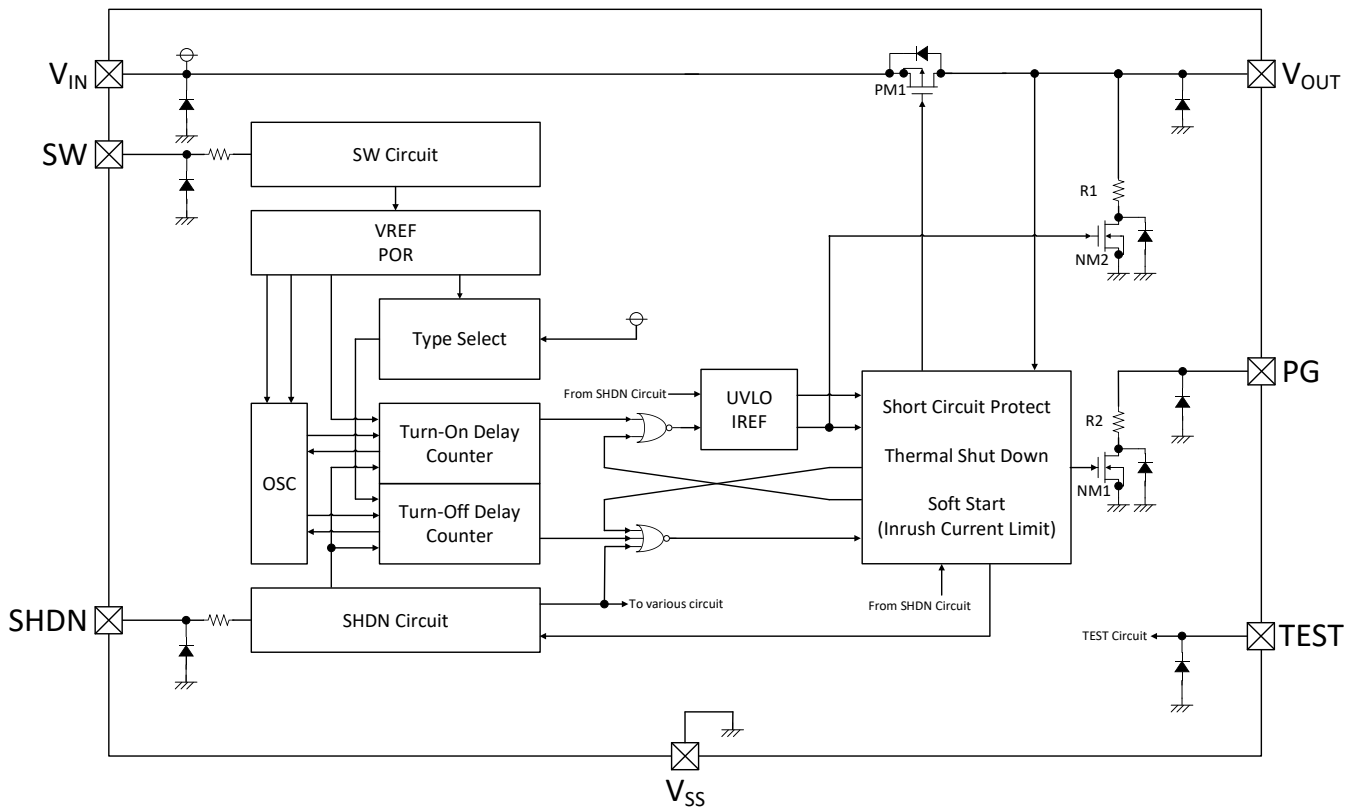

\*Diodes inside the circuit are an ESD protection diodes and a parasitic diodes.

## ■ PRODUCT CLASSIFICATION

### ● Ordering Information

XC6194①②③④⑤⑥-⑦<sup>(\*)</sup>

DESIGNATOR	DESCRIPTION	SYMBOL	DESCRIPTION
①	TYPE	A	Turn-on : By the SW pin Shut-down : By the SW pin or the SHDN pin
		B	Turn-on : By the SW pin Shut-down : By the SHDN pin
②	Turn-On delay time	A	0.2s.
		1	1s. option <sup>(*)2</sup>
		3	3s. option <sup>(*)2</sup>
		5	5s. option <sup>(*)2</sup>
③④	Turn-Off delay time	NN	It does not have "Turn-Off function by the SW pin". Applies to XC6194B only.
		03	3s. option <sup>(*)2</sup>
		05	5s.
		10	10s.
		15	15s. option <sup>(*)2</sup>
⑤⑥-⑦	Package and Taping Type	ER-G	USP-8B06 (5,000pcs/Reel)

<sup>(\*)1</sup> The "-G" suffix denotes Halogen and Antimony free as well as being fully EU RoHS compliant.

<sup>(\*)2</sup> For option products, please contact your local Torex sales office or representative.

### ● Selection Guide

Parts No.	Turn-On Delay Time	Turn-Off Delay Time	Package
XC6194AA05ER-G	0.2s	5s	USP-8B06
XC6194AA10ER-G		10s	
XC6194BANNER-G		Not applicable	

## PIN CONFIGURATION

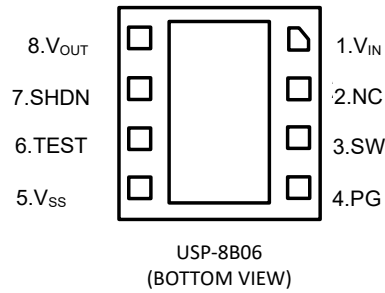

\*The dissipation pad for the USP-8B06 package should be solder-plated in recommended mount pattern and metal masking so as to enhance mounting strength and heat release. When taking out a potential of the heat-sink, connect with  $V_{SS}$  pin (#5 pin).

## PIN ASSIGNMENT

PIN NUMBER	PIN NAME	FUNCTION
USP-8B06		
1	$V_{IN}$	Power Supply Input
2	NC	No connection pin (The NC pin should be connected the $V_{SS}$ pin or be floated.)
3	SW	Push Button Signal input pin
4	PG	Power Good Status Output
5	$V_{SS}$	Ground Pin
6	TEST	The TEST pin must be connected the $V_{SS}$ pin.
7	SHDN	Forced Shutdown pin
8	$V_{OUT}$	Output pin

## PIN FUNCTION ASSIGNMENT

PIN NAME	SIGNAL	STATUS
SW	L	Active
	H	Keep the current state
	OPEN	Undefined State <sup>(*)</sup>
SHDN	L	Keep the current state
	H	Shut down
	OPEN	Undefined State <sup>(*)</sup>
PG	Low impedance	$V_{OUT}$ ="L" Level
	High impedance	$V_{OUT}$ ="H" Level

<sup>(\*)</sup> Please do not leave the SW pin and the SHDN pin open. Each should have a certain voltage

## ■ ABSOLUTE MAXIMUM RATINGS

PARAMETER		SYMBOL	RATINGS	UNITS
V <sub>IN</sub> Pin Voltage		V <sub>IN</sub>	-0.3 ~ 6.6	V
V <sub>OUT</sub> Pin Voltage		V <sub>OUT</sub>	-0.3 ~ V <sub>IN</sub> + 0.3 or 6.6 <sup>(*)</sup>	V
V <sub>OUT</sub> Pin Output Current		I <sub>OUT</sub>	1500	mA
SW Pin Voltage		V <sub>SW</sub>	-0.3 ~ 6.6	V
SHDN Pin Voltage		V <sub>SHDN</sub>	-0.3 ~ 6.6	V
PG Pin Voltage		V <sub>PG</sub>	-0.3 ~ 6.6	V
TEST Pin Voltage		V <sub>TEST</sub>	-0.3 ~ V <sub>IN</sub> + 0.3 or 6.6 <sup>(*)</sup>	V
Power Dissipation (Ta=25°C)	USP-8B06(DAF)	Pd	1240 (JESD51-7board) <sup>(*)</sup>	mW
			1800 (High heat dissipation board) <sup>(*)</sup>	
Operating Ambient Temperature		T <sub>opr</sub>	-40 ~ 85	°C
Storage Temperature		T <sub>stg</sub>	-55 ~ 125	°C

Each rating voltage is based on the V<sub>SS</sub>

<sup>(\*)</sup> Either of lower one, V<sub>IN</sub>+0.3V or 6.6V, is applicable.

<sup>(\*)</sup> The power dissipation figure shown is PCB mounted and is for reference only.

Please refer to PACKAGING INFORMATION for the mounting condition.

## ELECTRICAL CHARACTERISTICS (Continued)

XC6194 Series

Ta=25°C

PARAMETER	SYMBOL	CONDITIONS	MIN	TYP	MAX	UNIT	CIRCUIT
Input Voltage Range	V <sub>IN</sub>		1.8	-	6.0	V	(1)
Stand-by Current <sup>(*1)</sup>	I <sub>STB</sub>	V <sub>IN</sub> =6.0V, V <sub>SW</sub> =V <sub>IN</sub>	-0.10	0.001	0.10	μA	(1)
Operation Current <sup>(*2)</sup>	I <sub>OP</sub>	Turn-Off states, V <sub>IN</sub> =6.0V, V <sub>SW</sub> =0V,	-	48	91	μA	(1)
Quiescent Current <sup>(*3)</sup>	I <sub>Q</sub>	Turn-On keeps, V <sub>IN</sub> =6.0V, V <sub>SW</sub> =V <sub>IN</sub>	-	0.13	0.42	μA	(1)
UVLO Detect Voltage	V <sub>UVLO</sub>	Turn-On States, V <sub>IN</sub> condition	1.1	1.2	1.37	V	(1)
UVLO Detect Delay Time	t <sub>UVLO</sub>	After UVLO detected	100	-	-	μs	(1)
Turn-On Delay Time <sup>(*4)</sup>	t <sub>OND</sub>	XC6194xAxx Change the V <sub>SW</sub> from V <sub>IN</sub> to 0V.	0.18	0.20	0.22	s	(1)
		XC6194x1xx Change the V <sub>SW</sub> from V <sub>IN</sub> to 0V.	0.90	1.00	1.10		
		XC6194x3xx Change the V <sub>SW</sub> from V <sub>IN</sub> to 0V.	2.70	3.00	3.30		
		XC6194x5xx Change the V <sub>SW</sub> from V <sub>IN</sub> to 0V.	4.50	5.00	5.50		
Turn-Off Delay Time <sup>(*5)(*6)</sup>	t <sub>OFFD</sub>	XC6194Ax03 Change the V <sub>SW</sub> from V <sub>IN</sub> to 0V.	2.70	3.00	3.30	s	(1)
		XC6194Ax05 Change the V <sub>SW</sub> from V <sub>IN</sub> to 0V.	4.50	5.0	5.50		
		XC6194Ax10 Change the V <sub>SW</sub> from V <sub>IN</sub> to 0V.	9.0	10.0	11.0		
		XC6194Ax15 Change the V <sub>SW</sub> from V <sub>IN</sub> to 0V.	13.5	15.0	16.5		
Thermal shutdown Detect Temperature	T <sub>TSDD</sub>	After detected the voltage drop due to the ON resistance of the driver transistor.	-	125	-	°C	(1)
Thermal shutdown Release Temperature	T <sub>TSDR</sub>		-	105	-		
Short Circuit Detect Voltage	V <sub>SHORT</sub>	V <sub>OUT</sub> condition	V <sub>IN</sub> - 0.85	V <sub>IN</sub> - 0.55	V <sub>IN</sub> - 0.25	V	(1)
Short Circuit Detect Delay Time	t <sub>SHORT</sub>	After short detected, V <sub>SW</sub> =V <sub>IN</sub>	80	-	-	μs	(1)

Unless otherwise stated, V<sub>SS</sub> common, V<sub>IN</sub>=6.0V, V<sub>SW</sub>=6.0V, V<sub>SHDN</sub>=0V, V<sub>PG</sub>=Open, I<sub>OUT</sub>=0mA, C<sub>IN</sub>=0.1μF, C<sub>L</sub>=0.1μF

(\*1) Self-supply current when V<sub>OUT</sub> is in the Turn-off state and V<sub>IN</sub> level is input into the V<sub>SW</sub> pin.

(\*2) Self-supply current when V<sub>OUT</sub> is in the Turn-off state and "L" level is input into the V<sub>SW</sub> pin.

(\*3) Self-supply current when V<sub>OUT</sub> is in the Turn-on state and V<sub>IN</sub> level is input into the V<sub>SW</sub> pin.

(\*4) Time from SW pin "L" level until V<sub>OUT</sub> pin "H" level<sup>(\*7)</sup> pin in the Turn-off state.

(\*5) Time from SW pin "L" level until V<sub>OUT</sub> pin "L" level<sup>(\*8)</sup> pin in the Turn-on state.

(\*6) Type B does not have this function.

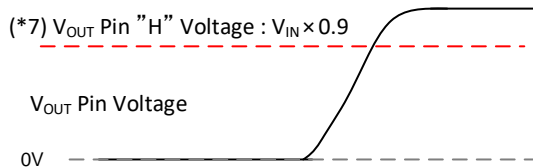

V<sub>OUT</sub> pin "H" Voltage

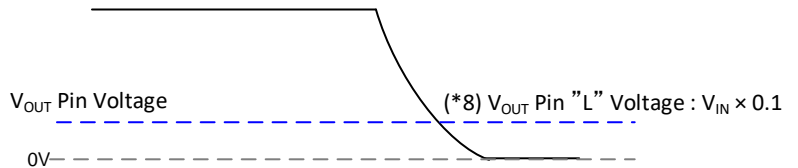

V<sub>OUT</sub> pin "L" Voltage

## ■ ELECTRICAL CHARACTERISTICS (Continued)

XC6194 Series

Ta=25°C

PARAMETER	SYMBOL	CONDITIONS	MIN	TYP	MAX	UNIT	CIRCUIT
Main Driver On Resistor	R <sub>ON</sub>	Turn-On states, V <sub>IN</sub> =1.8V	0.145	0.19	0.46	Ω	(1)
		Turn-On states, V <sub>IN</sub> =2.0V	0.135	0.18	0.40		
		Turn-On states, V <sub>IN</sub> =3.0V	0.110	0.14	0.26		
		Turn-On states, V <sub>IN</sub> =6.0V	0.085	0.11	0.20		
SW pin "H" Voltage	V <sub>SWH</sub>		1.1	-	6.0	V	(1)
SW pin "L" Voltage	V <sub>SWL</sub>		0	-	0.4	V	(1)
SW pin "H" Current	I <sub>SWH</sub>	V <sub>SW</sub> =6.0V	-0.10	0.01	0.10	μA	(1)
SW pin "L" Current	I <sub>SWL</sub>	V <sub>SW</sub> =0V	-0.10	0.01	0.10	μA	(1)
SHDN pin "H" Voltage	V <sub>SHDNH</sub>		1.1	-	6.0	V	(1)
SHDN pin "L" Voltage	V <sub>SHDNL</sub>		0	-	0.4	V	(1)
SHDN pin "H" Current	I <sub>SHDNH</sub>	V <sub>SHDN</sub> =6.0V	-0.10	0.01	0.10	μA	(1)
SHDN pin "L" Current	I <sub>SHDNL</sub>	V <sub>SHDN</sub> =0V	-0.10	0.01	0.10	μA	(1)
PG pin Output Current	I <sub>PG</sub>	Turn-Off states, V <sub>IN</sub> =1.8V, V <sub>GATE</sub> =0.3V	1	-	-	mA	(1)
PG pin Leak Current	I <sub>PGL</sub>	Turn-On states, V <sub>IN</sub> =6.0V, V <sub>PG</sub> =6.0V	-0.10	0.01	0.10	μA	(1)
CL Discharge Current	I <sub>DCG</sub>	Turn-Off states, V <sub>IN</sub> =1.8V, V <sub>OUT</sub> =0.3V	1	-	-	mA	(1)

Unless otherwise stated, V<sub>SS</sub> common, V<sub>IN</sub>=6.0V, V<sub>SW</sub>=6.0V, V<sub>SHDN</sub>=0V, V<sub>PG</sub>=Open, I<sub>OUT</sub>=0mA, C<sub>IN</sub>=0.1μF, C<sub>L</sub>=0.1μF





■ TYPICAL APPLICATION CIRCUIT

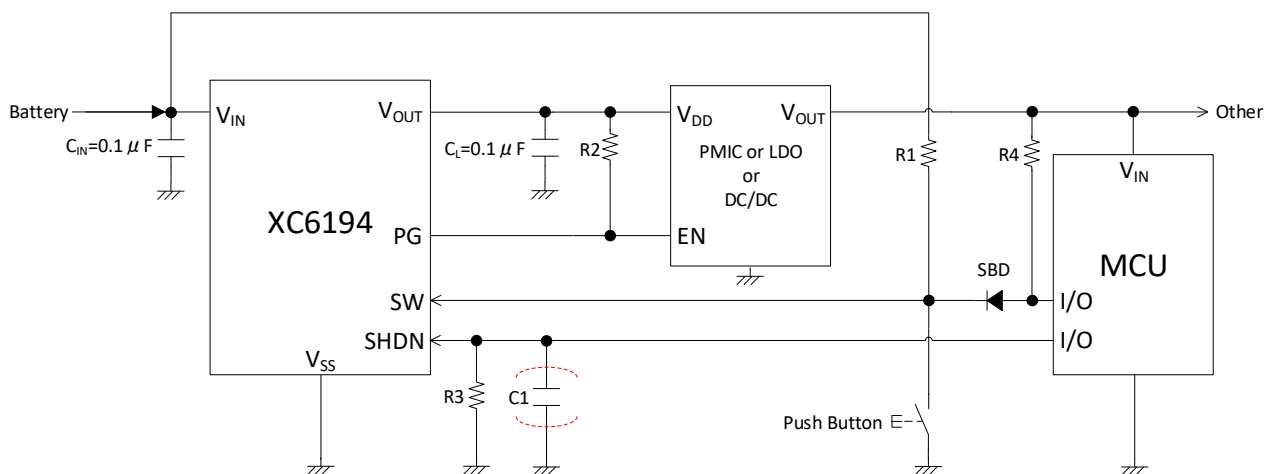

【Typical Examples】

	VALUE	MANUFACTURER	PRODUCT NUMBER
SBD <sup>(*)</sup>	$V_F = 0.37V$	Panjit	RB751S40
CIN	0.1uF / 10V (Ceramic)		
CL	0.1uF / 10V (Ceramic)		
C1	Set it as necessary. (Example: 0.1μF~ 1μF)		
R1	200kΩ		
R2	200kΩ		
R3	5kΩ		
R4	47kΩ		

<sup>(\*)</sup> Please select freely according to the threshold of the MCU's I/O.



## ■ OPERATIONAL EXPLANATION (Continued)

### [Turn-On sequence: Fig.3]

If Voltage “Low” is input over the duration of  $T_{OND}$  to the SW pin while  $V_{OUT}$  is fixed at Voltage “Low”,  $V_{OUT}$  will begin to rise while the output current is being suppressed by the inrush current limit soft-start function, which will gradually turns on the Pch driver transistor PM1 (refer to Fig.1).

Even if the SW pin voltage changes to the Voltage “High” while  $V_{OUT}$  is rising,  $V_{OUT}$  will ultimately be fixed at Voltage “High”.

When the gate voltage of the PM1 has dropped sufficiently, the NM1 connected to the PG pin will turns off, and the PG pin will have a high-impedance.

In addition, by connecting the PG pin to the Enable pin of the device that follows the XC6194 series, malfunctioning of that device is prevented. (Fig. 2)

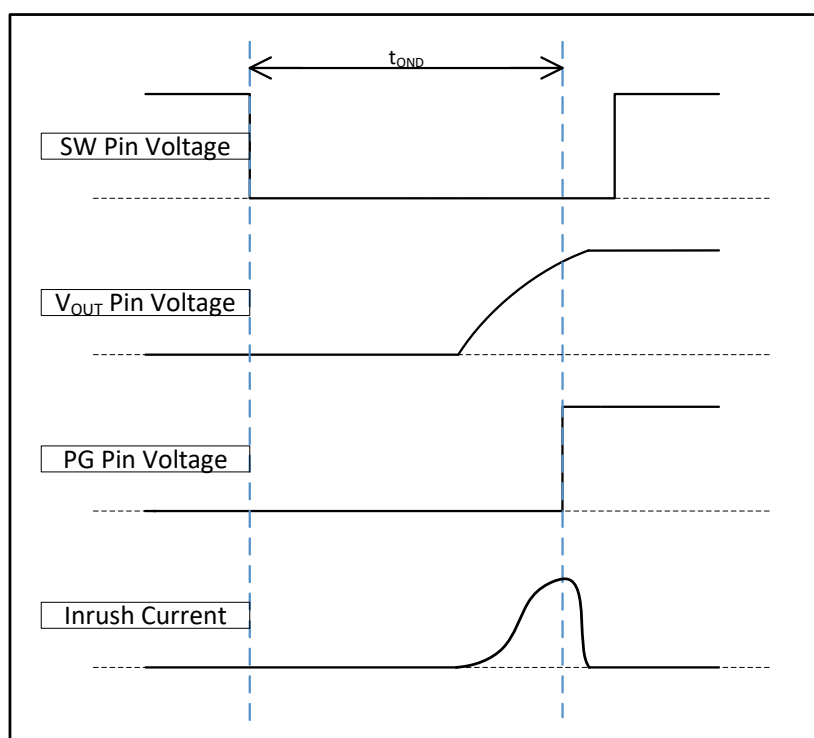

Fig.3 Turn-On sequence

## OPERATIONAL EXPLANATION (Continued)

### [Shutdown sequence: Fig.4]

In the XC6194 series, when one pulse of "H" voltage (at least  $100\mu\text{s}$  as a guideline) is input into the SHDN pin with  $V_{\text{OUT}}$  fixed at "H" voltage,  $V_{\text{OUT}}$  changes to the shutdown state and the IC enters the standby state.

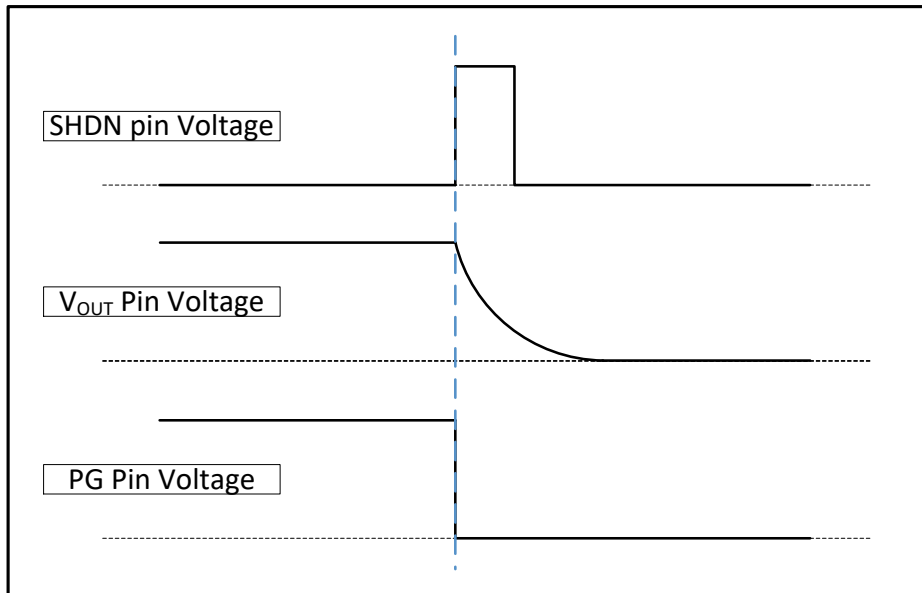

Fig.4 Shutdown sequence

### [Turn-Off sequence: Fig.5]

On the A type, when "L" voltage is input into the SW pin for the duration  $t_{\text{OFFD}}$  with  $V_{\text{OUT}}$  fixed at "H" voltage,  $V_{\text{OUT}}$  shuts down. After shutdown, returning the SW pin to "H" voltage reduces the supply current to the standby current while holding the IC's logic. The B type does not have this function.

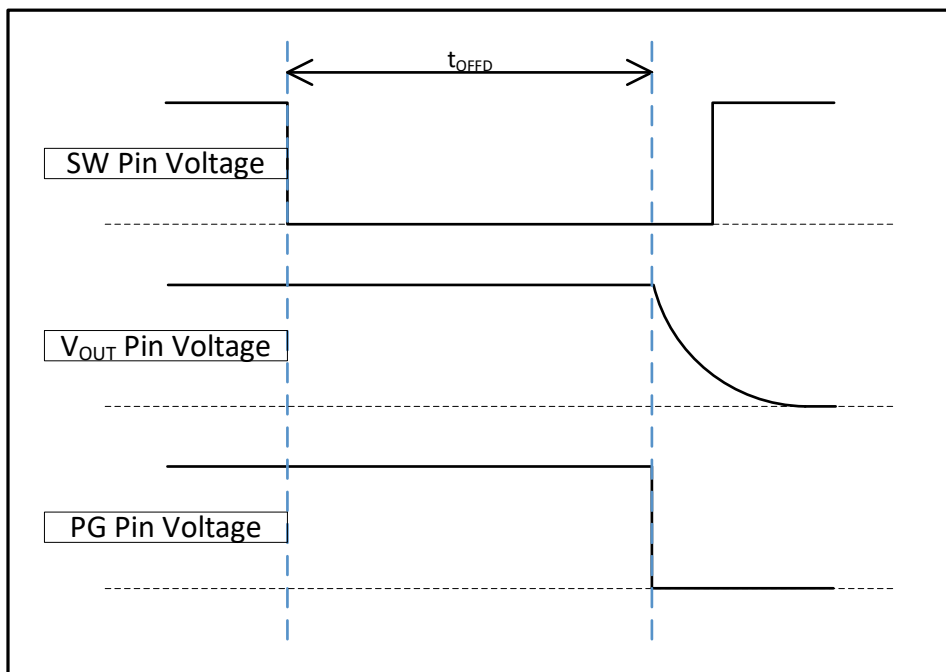

Fig.5 Turn-Off sequence

## OPERATIONAL EXPLANATION (Continued)

### [Operation after Turn-On: Fig.6]

On the A type, when "L" voltage is input into the SW pin for the duration  $t_{OND}$  and  $V_{OUT}$  is fixed at "H" voltage, and then "L" voltage is input into the SW pin for the duration  $t_{OFFD}$ , the Turn-Off sequence cannot be initiated.

To initiate the Turn-Off sequence, "H" voltage must be input into the SW pin, and then "L" voltage must again be input for the duration  $t_{OFFD}$ .

The B type does not have a Turn-Off sequence by SW pin.

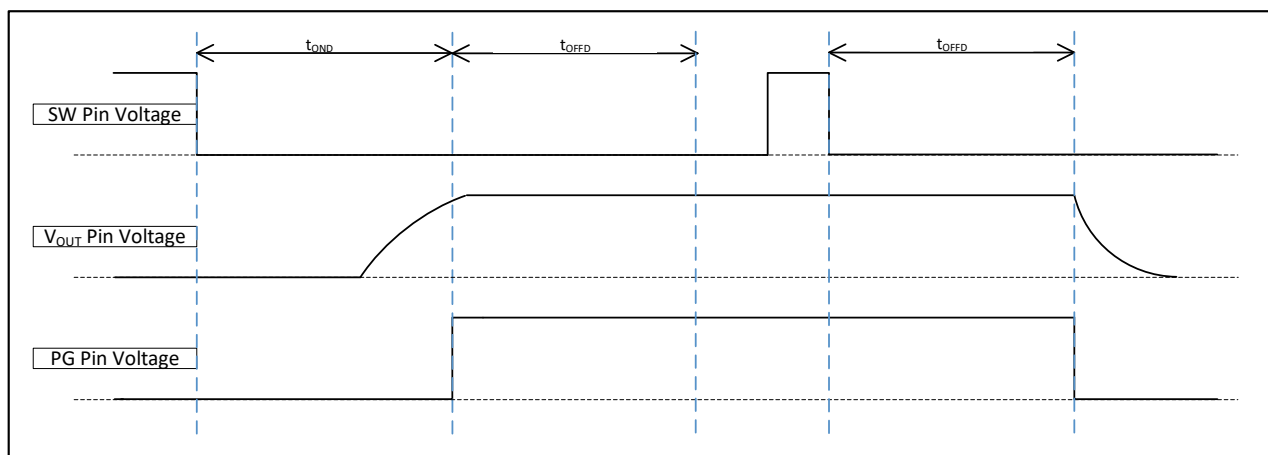

Fig.6 Operation after Turn-On

### [Operation after Turn-Off: Fig.7]

On the A type, when "L" voltage is input into the SW pin for the duration  $t_{OFFD}$  and  $V_{OUT}$  is shut down, and then "L" voltage is input into the SW pin for the duration  $t_{OND}$ , the Turn-On sequence cannot be initiated.

To initiate the Turn-On sequence, "H" voltage must be input into the SW pin, and then "L" voltage must again be input for the duration  $t_{OND}$ .

The B type does not have a Turn-Off sequence by SW pin.

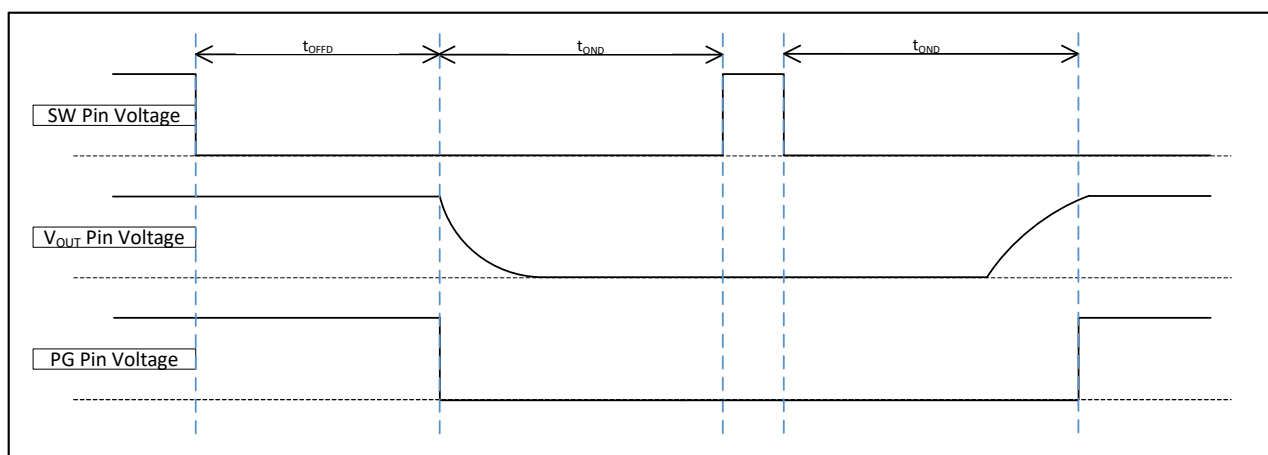

Fig.7 Operation after Turn-Off

## OPERATIONAL EXPLANATION (Continued)

### [Operation after shutdown: Fig.8]

In the XC6194 series, in order to initiate the Turn-On sequence after “H” voltage is input into the SHDN pin and  $V_{OUT}$  is shut down, “H” voltage must be input into the SW pin and then “L” voltage must again be input for the duration  $t_{OND}$ .

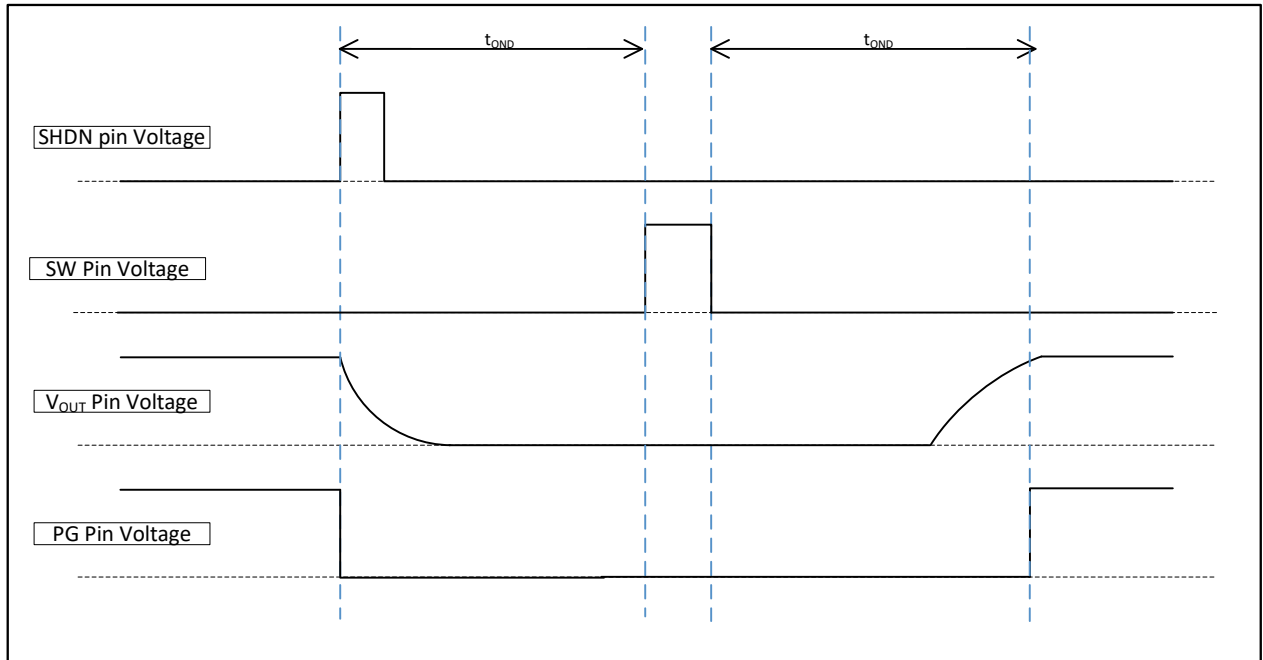

Fig.8 Operation after shutdown

## ■ OPERATIONAL EXPLANATION (Continued)

### [Thermal shutdown function: Fig.9]

The XC6194 series are equipped with thermal shutdown functions.

If a load current causes the  $V_{OUT}$  pin voltage to drop by roughly 50mV(TYP.) compared to the  $V_{IN}$  pin voltage, the overheat protection circuit will be activated and begin monitoring the IC heat generation.

If the IC temperature is equal to or greater than the Thermal Shutdown Detect Temperature ( $T_{TSD}$ : refer to Electrical Characteristics), the function will turn PM1 OFF and stop the supply of load current.

Also, if the discontinuation of the load current supply causes the IC temperature is equal to or less than the Thermal Shutdown Release Temperature ( $T_{TSDR}$ : refer to Electrical Characteristics), the IC operation will automatically be restored. The inrush current limit soft start function also operates during automatic restoration.

However, if the  $V_{OUT}$  pin voltage is equal to or less than the Short Circuit Detect Voltage ( $V_{SHORT}$ : refer to Electrical Characteristics) before the IC temperature is equal to or less than  $T_{TSDR}$ , the IC will shut down.

Then, by performing turn-on sequence (refer to Fig.3: Turn-On Sequence),  $V_{OUT}$  is turned on again.

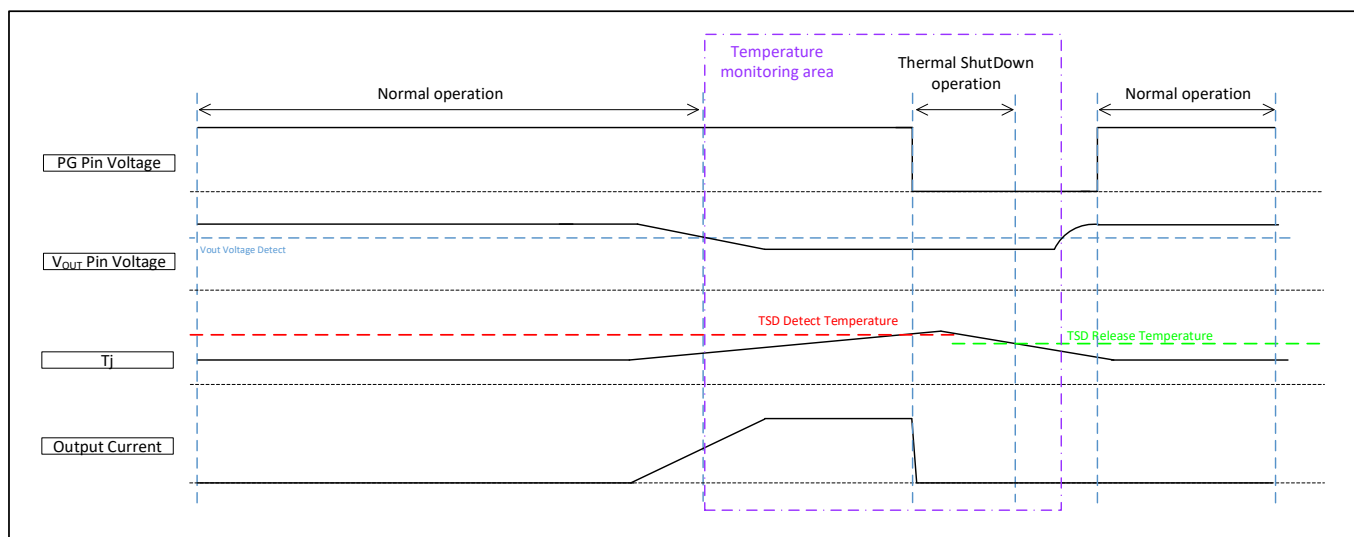

**Fig.9 Thermal shutdown function**

## OPERATIONAL EXPLANATION (Continued)

### [Inrush current limit and output short circuit protection: Fig.10]

The XC6194 series are equipped with the inrush current limiting soft-start function and the function of shutting down the output when output short circuit is detected.

After the Turn-On sequence (refer to Fig.3: Turn-On Sequence), if the  $V_{OUT}$  pin voltage is equal to or less than the Short Circuit Detect Voltage ( $V_{SHORT}$ : refer to Electrical Characteristics) for a duration equal to or longer than the Short Circuit Detect Delay Time ( $T_{SHORT}$ : refer to Electrical Characteristics), it will be identified as output short. And the PM1 is latched off-state, causes  $V_{OUT}$  to shut down.

The relation between the output current ( $I_{SHORT}$ ) and  $V_{SHORT}$  when output short occurs is given by the equation below.

$$I_{SHORT} = (V_{IN} - V_{SHORT}) / R_{ON} \text{ (A)}$$

\*  $R_{ON\_min}$  is interlocked with  $V_{SHORT\_max}$ , and  $R_{ON\_max}$  is interlocked with  $R_{ON\_min}$

During the Turn-On sequence, if the  $V_{OUT}$  pin voltage is equal to or less than the  $V_{SHORT}$  voltage, the output short-circuit protection function will not operate.

Once the  $V_{OUT}$  pin voltage is greater than the  $V_{SHORT}$  voltage, the output short-circuit protection function will begin to operate.

The equation for the maximum output current is as follows.

$$I_{OUT} \text{ (Min.)} = (V_{IN} - V_{SHORT\_max}) / R_{ON\_min} \text{ (A)}$$

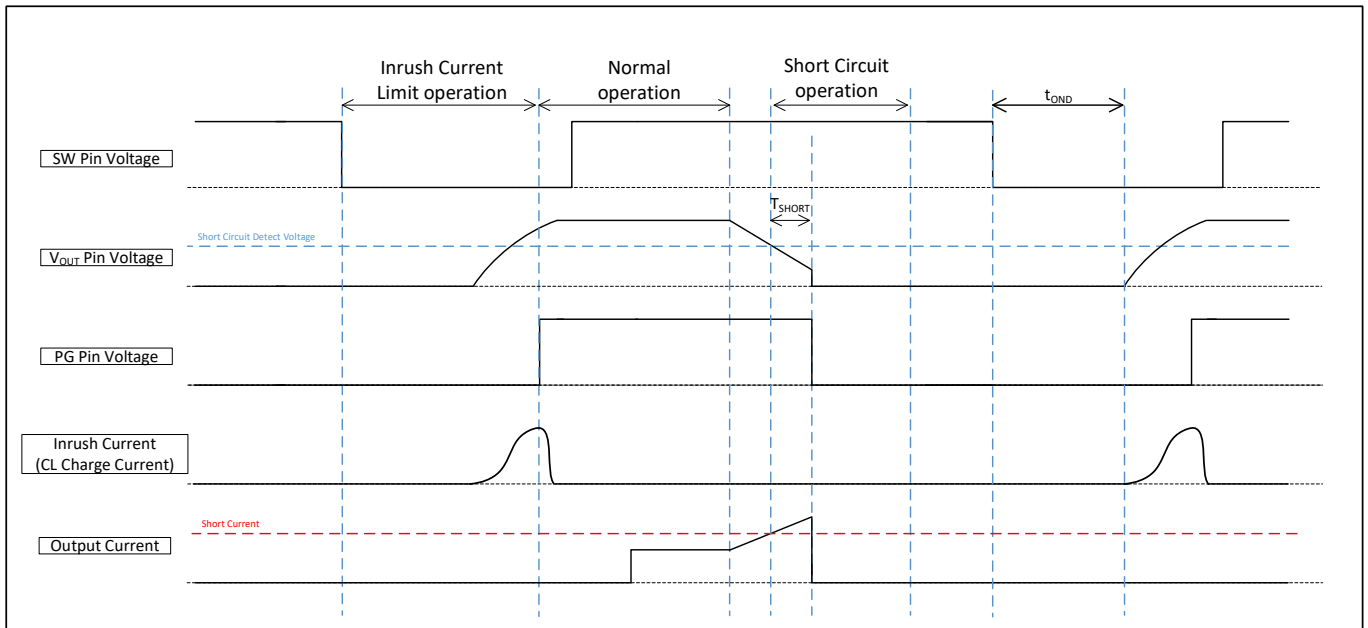

Fig.10 Inrush current limit and short circuit protection



## ■ OPERATIONAL EXPLANATION (Continued)

### [SW pin]

When “L” voltage is input into the SW pin for the duration  $t_{\text{OND}}$  with the IC in the standby state, the pin fixes  $V_{\text{OUT}}$  at “H” voltage. On the A type, when  $V_{\text{OUT}}$  is fixed at “H” voltage, “L” voltage can be input for the duration  $t_{\text{OFFD}}$  to shut down  $V_{\text{OUT}}$ .

### [SHDN pin]

This pin shuts down  $V_{\text{OUT}}$  when one pulse of “H” voltage (100 $\mu$ s or more as a guideline) is input into the SHDN pin with  $V_{\text{OUT}}$  fixed at “H” voltage.

### [PG pin]

PG pin are connected with NM1 and R2(Fig.1).

Since NM1 is the N-ch MOSFET and it is synchronized with the GATE signal of PM1, if PM1 turns ON, NM1 will turn OFF, and if PM1 turns OFF, NM1 will turn ON.

### [VOUT pin]

$V_{\text{OUT}}$  pin is connected with PM1, R1 (Fig. 1) and CL discharge transistor NM2 (Fig. 1).

PM1 is a Pch MOSFET and functions as the main driver.

NM2 is an Nch MOSFET, and is synchronized with the GATE signal of PM1. Therefore, when PM1 turns ON, NM2 turns OFF.

### [SW Circuit]

This circuit transmits the signal input into the SW pin to the internal circuitry.

### [SHDN Circuit]

This circuit transmits the signal input into the SHDN pin to the internal circuitry.

### [VREF & POR]

This circuit supplies the internal circuit with reference voltage as well as a reset signal to the logic circuitry.

### [Type Select]

This circuit selects the product type.

### [Turn-On Delay Counter]

This circuit count-controls the time until  $V_{\text{OUT}}$  is fixed at “H” voltage after “L” voltage is input into the SW pin.

During the time until the count is completed, the counter circuit can be returned to the initial state by inputting “H” voltage into the SW pin.

### [Turn-Off Delay Counter]

This circuit only operates on the A type.

When  $V_{\text{OUT}}$  is fixed at “H” voltage, this circuit count-controls the time from input of “L” voltage into the SW pin until  $V_{\text{OUT}}$  shuts down.

During the time until the count is completed, the counter circuit can be returned to the initial state by inputting “H” voltage into the SW pin.

### [UVLO]

It is Under Voltage Lock Out circuit.  $V_{\text{OUT}}$  will shut down if the input voltage is less than  $V_{\text{UVLO}}$ .

### [IREF]

It is internal circuit reference current source.

### [Soft Start (Inrush Current Limit)]

A circuit which slowly switches the PM1 gate voltage from Voltage “High” to Voltage “Low”, and limits the inrush current.

### [Short Circuit Protect]

This circuit outputs a signal to shut down if the  $V_{\text{OUT}}$  pin voltage reaches  $V_{\text{SHORT}}$ .

Also, this function will stop until  $V_{\text{OUT}}$  turns ON and reaches  $V_{\text{SHORT}}$ . Until then, only the Thermal Shutdown circuit will operate as a protection function.

### [Thermal Shutdown]

If a load current causes the  $V_{\text{OUT}}$  pin voltage to drop by roughly 50mV (TYP.) compared to the  $V_{\text{IN}}$  pin voltage, this function will begin monitoring the IC heat generation. If the IC temperature is equal to or greater than  $T_{\text{TSDD}}$ , it will turn off the PM1 and stop the supply of load current.

## ■ NOTES ON USE

- 1) For temporary, transitional voltage drop or voltage rising phenomenon, the IC is liable to malfunction should the ratings be exceeded.
- 2) Please use this IC within the specified operating ranges.
- 3) In some cases, power supply noise may cause malfunctioning of the internal counter circuit. Sufficiently reinforce the  $V_{IN}$ ,  $V_{OUT}$ , and GND lines, and connect 0.1 $\mu$ F or higher capacitors near the IC between  $V_{IN}$  and GND ( $V_{SS}$ ), and between  $V_{OUT}$  and GND ( $V_{SS}$ ).
- 4) When using the capacitor larger than 100 $\mu$ F for  $C_L$ , it is possible that Inrush Current becomes large. Please sufficiently test actual operation before use.
- 5) When "L" level is input into the SW pin, Operation Current flows. Sufficiently test actual operation before designing peripheral circuits.
- 6) The SW pin and SHDN pin are connected to the gate of a CMOS inverter. If a voltage lower than the  $V_{IN}$  pin voltage or a voltage higher than the  $V_{SS}$  pin voltage is input into each pin, the flow-through current of the CMOS inverter may appear as supply current.
- 7) If an intermediate voltage between "L" voltage and "H" voltage is input into the SW pin or SHDN pin, starting and stopping of the IC may become unstable. Sufficiently test peripheral components and other parts to ensure that an intermediate voltage between "L" voltage and "H" voltage is not continuously input for an excessive time into the SW pin and the SHDN pin.
- 8) Since electromagnetic wave may cause unexpected malfunction, please reinforce the shielding of the equipment and connect a filter to each terminal as necessary and fully check with actual equipment before using.
- 9) The TEST pin must be connected to GND ( $V_{SS}$ ).
- 10) When transiently varying the input voltage, please make sure to set the slew rate under 1V/us.
- 11) When using for an application other than a push-button application, please design the timing to include deviations and test sufficiently with the actual device before use.
- 12) Torex places an importance on improving our products and their reliability.  
We request that users incorporate fail-safe designs and post-aging protection treatment when using Torex products in their systems.

## TYPICAL PERFORMANCE CHARACTERISTICS

(1) Standby Current vs. Input Voltage

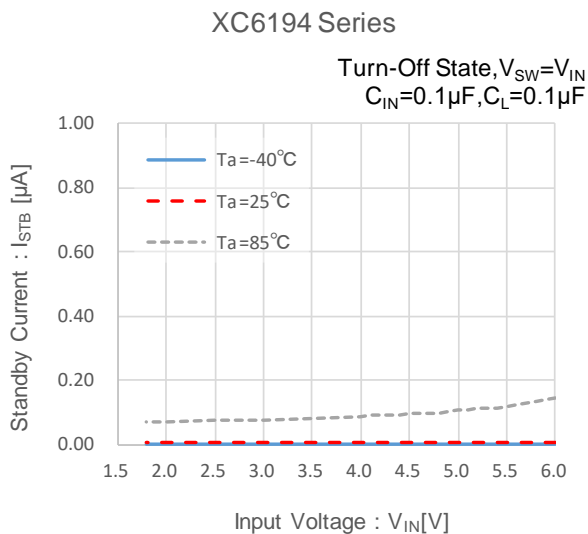

(2) Standby Current vs. Ambient Temperature

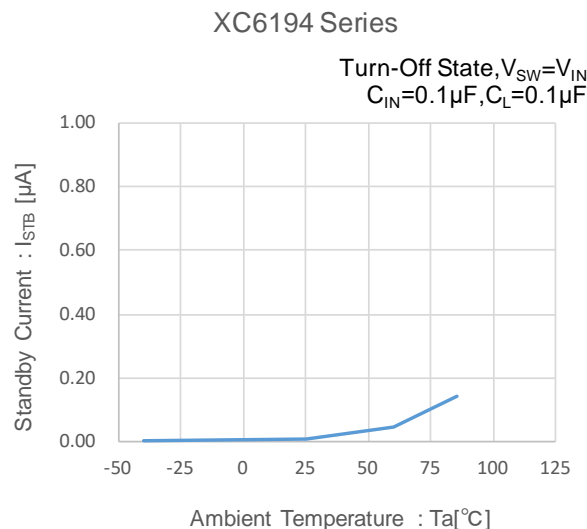

(3) Quiescent Current vs. Input Voltage

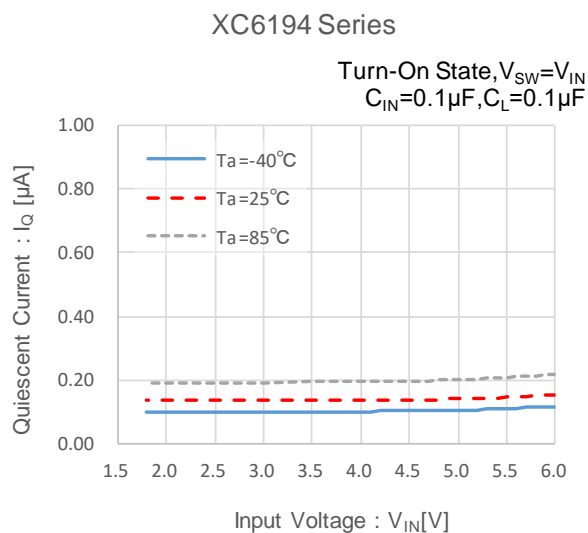

(4) Quiescent Current vs. Ambient Temperature

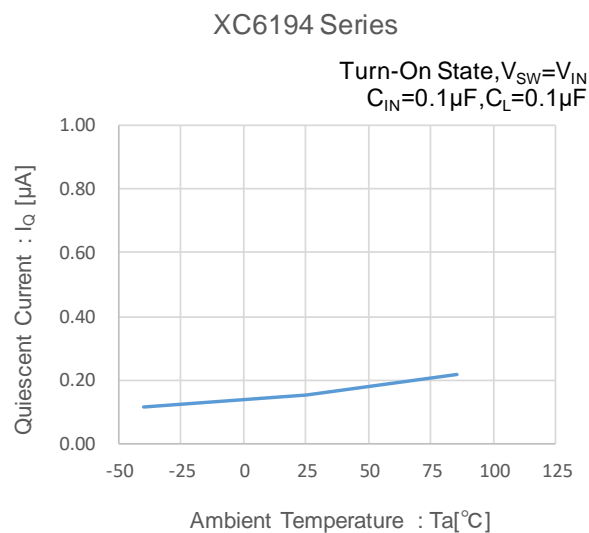

(5) Operation Current vs. Input Voltage

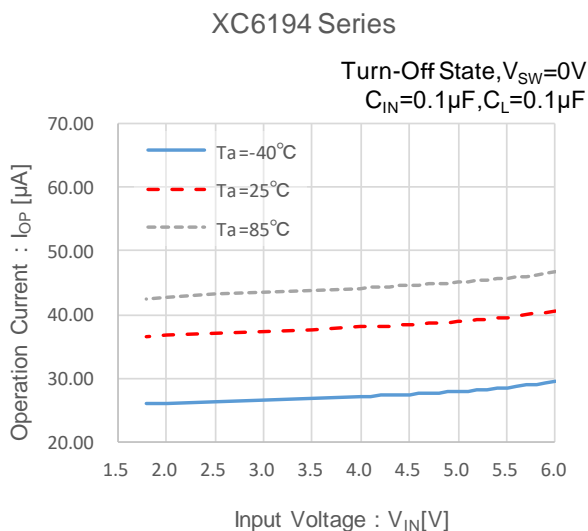

(6) Operation Current vs. Ambient Temperature

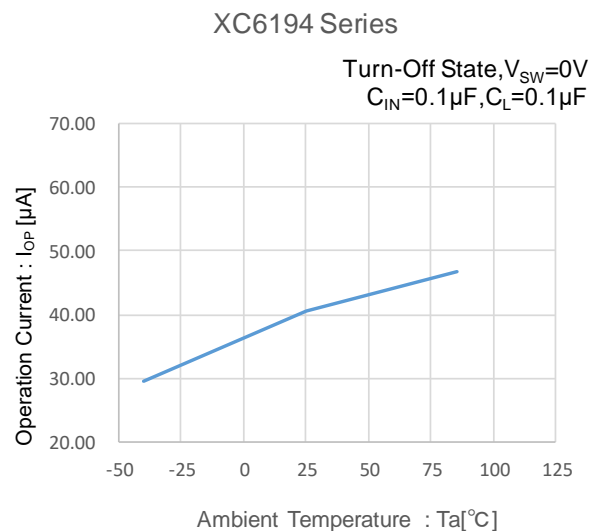

## TYPICAL PERFORMANCE CHARACTERISTICS (Continued)

### (7) Turn-On Delay Time vs. Ambient Temperature

XC6194xAxx

$V_{IN}=3.0V, V_{SW}=V_{IN}->0V$   
 $C_{IN}=0.1\mu F, C_L=0.1\mu F$

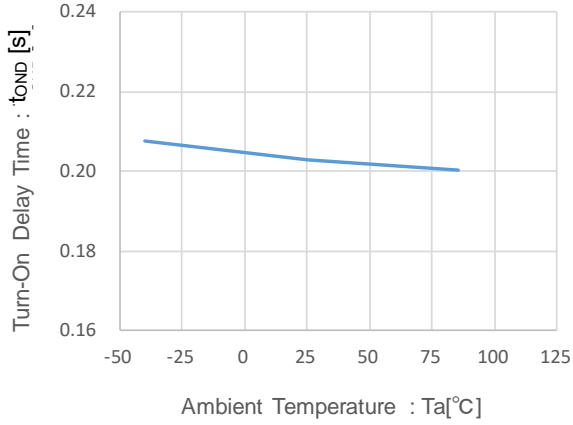

XC6194x1xx

$V_{IN}=3.0V, V_{SW}=V_{IN}->0V$   
 $C_{IN}=0.1\mu F, C_L=0.1\mu F$

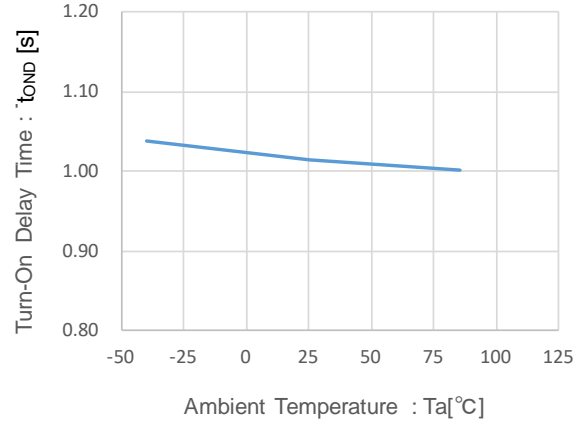

XC6194x3xx

$V_{IN}=3.0V, V_{SW}=V_{IN}->0V$   
 $C_{IN}=0.1\mu F, C_L=0.1\mu F$

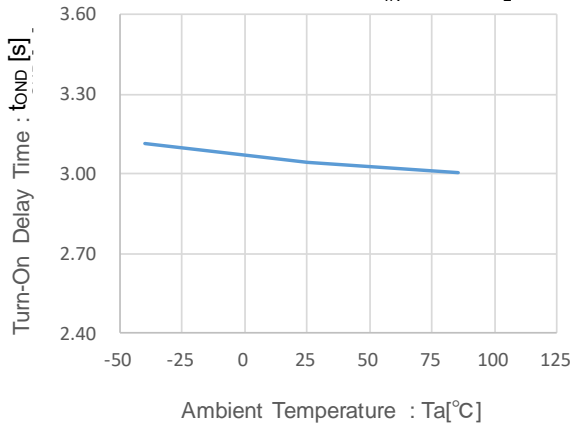

XC6194x5xx

$V_{IN}=3.0V, V_{SW}=V_{IN}->0V$   
 $C_{IN}=0.1\mu F, C_L=0.1\mu F$

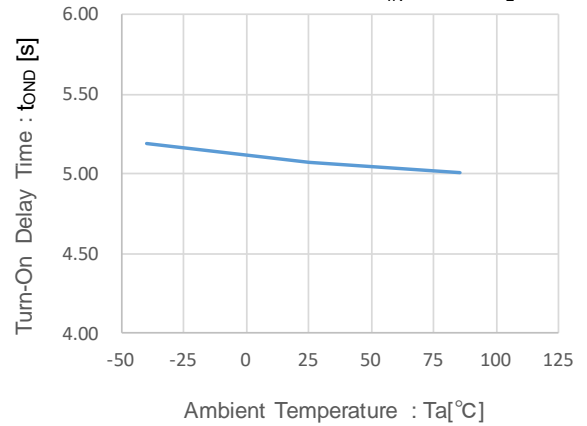

## ■ TYPICAL PERFORMANCE CHARACTERISTICS (Continued)

### (8) Turn-Off Delay Time vs. Ambient Temperature

XC6194Ax03

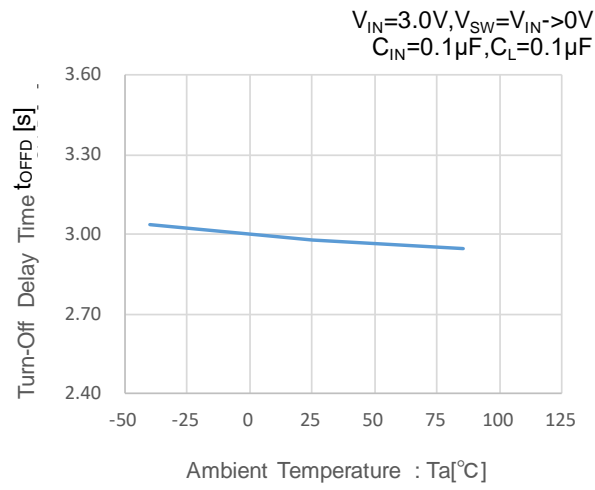

XC6194Ax05

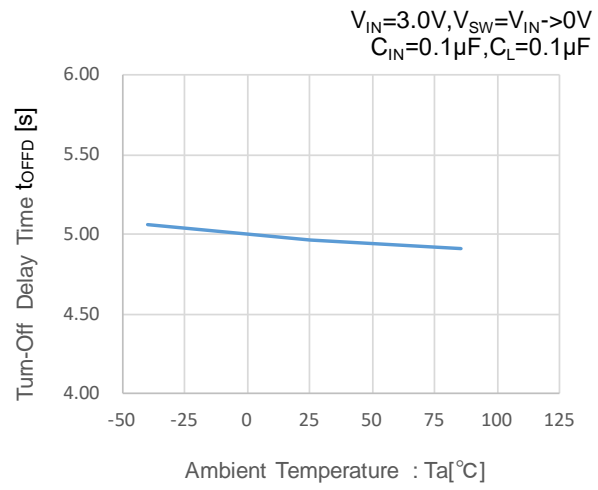

XC6194Ax10

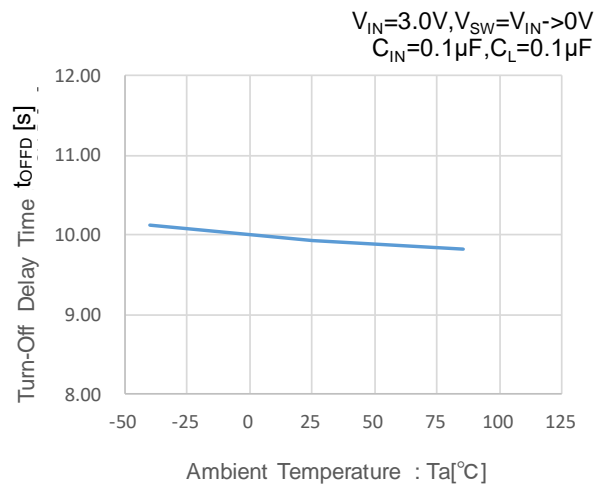

XC6194Ax15

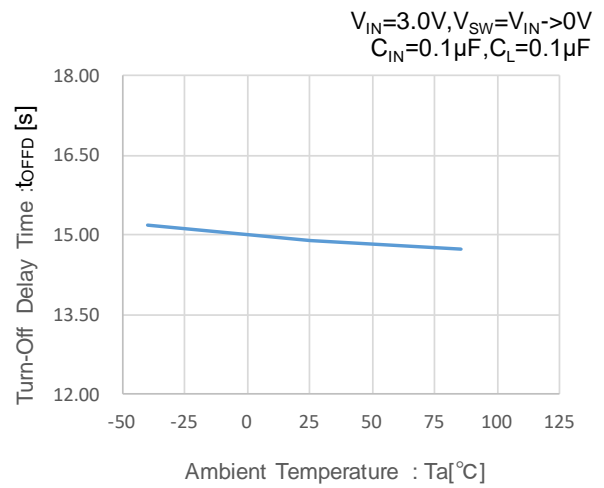

## TYPICAL PERFORMANCE CHARACTERISTICS (Continued)

### (9) Main driver On Resistor vs. Ambient Temperature

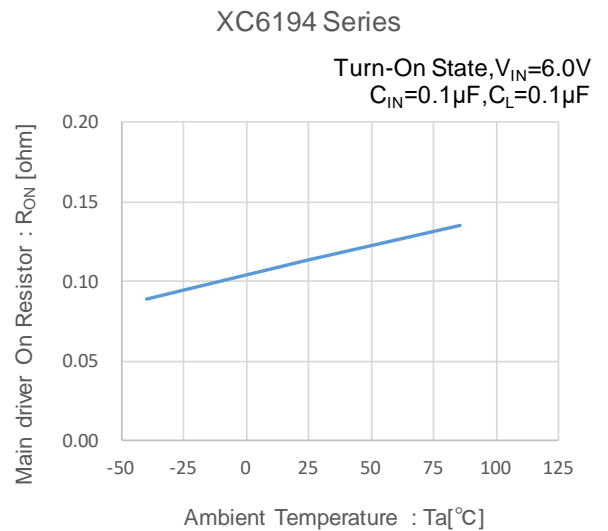
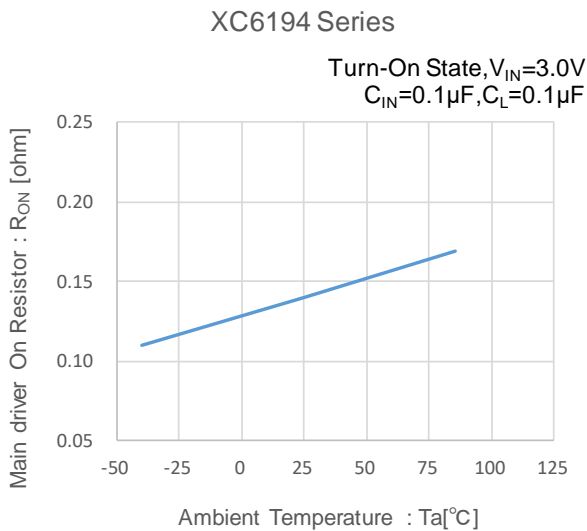
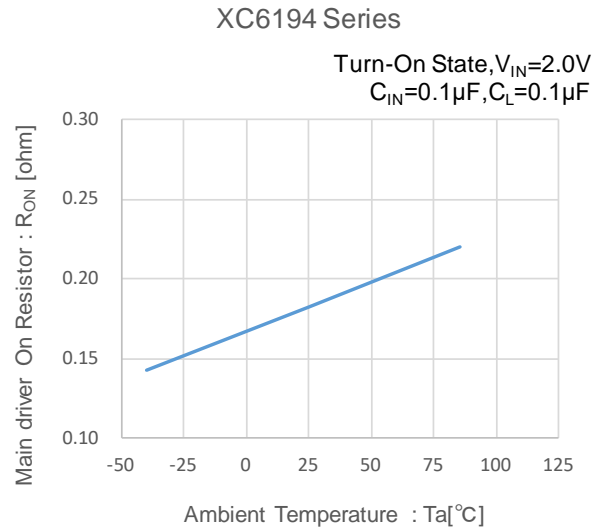
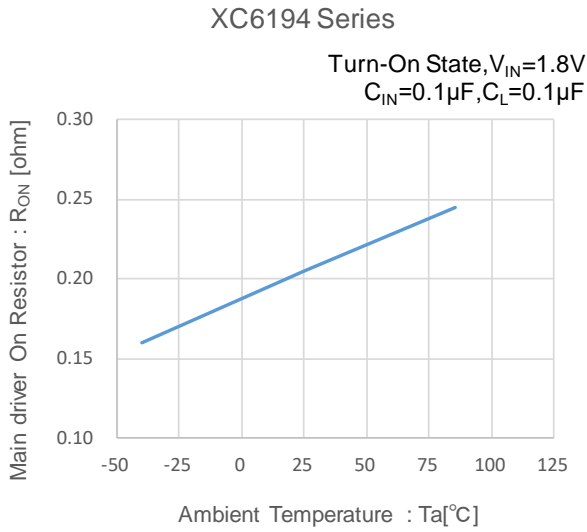

## ■ TYPICAL PERFORMANCE CHARACTERISTICS (Continued)

(10) SW pin "H" "L" Voltage vs. Ambient Temperature

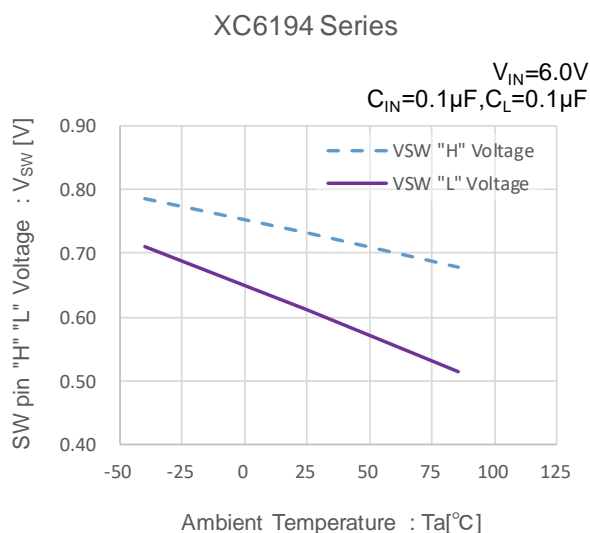
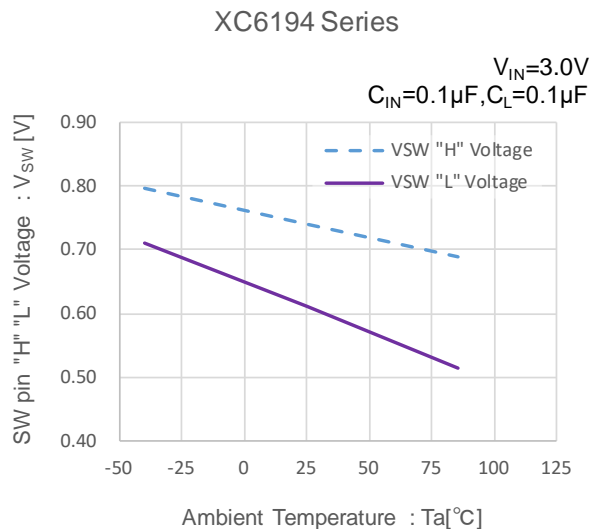
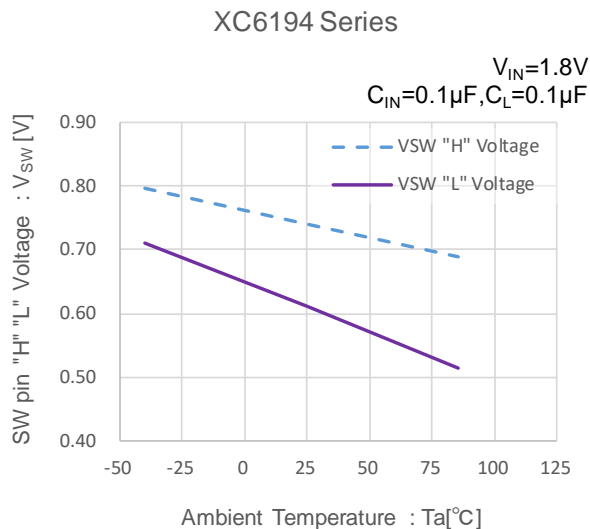

## TYPICAL PERFORMANCE CHARACTERISTICS (Continued)

(11) SHDN pin "H" "L" Voltage vs. Ambient Temperature

XC6194 Series

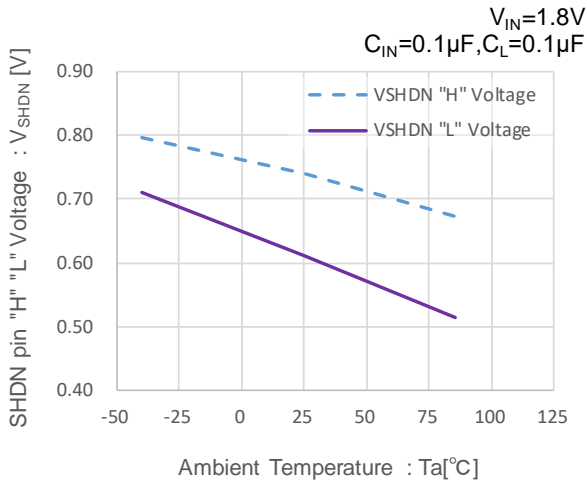

XC6194 Series

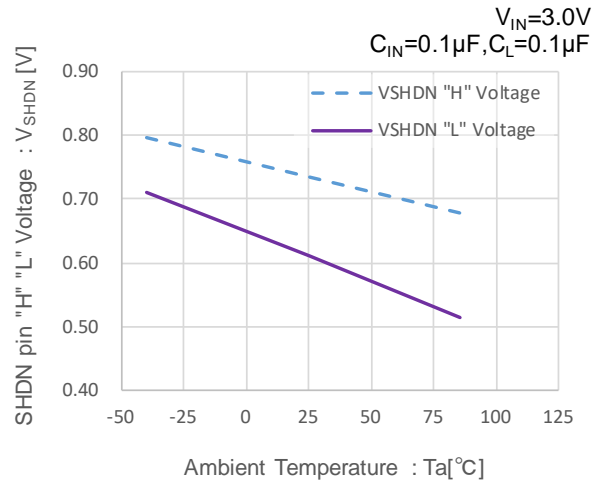

XC6194 Series

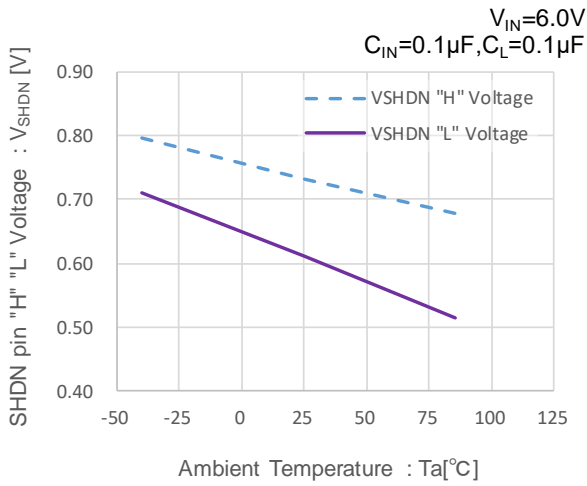



## ■ TYPICAL PERFORMANCE CHARACTERISTICS (Continued)

(14) Inrush Current caused by load capacitance

XC6194 Series

VIN=6.0V  
SW=6.0V→0V

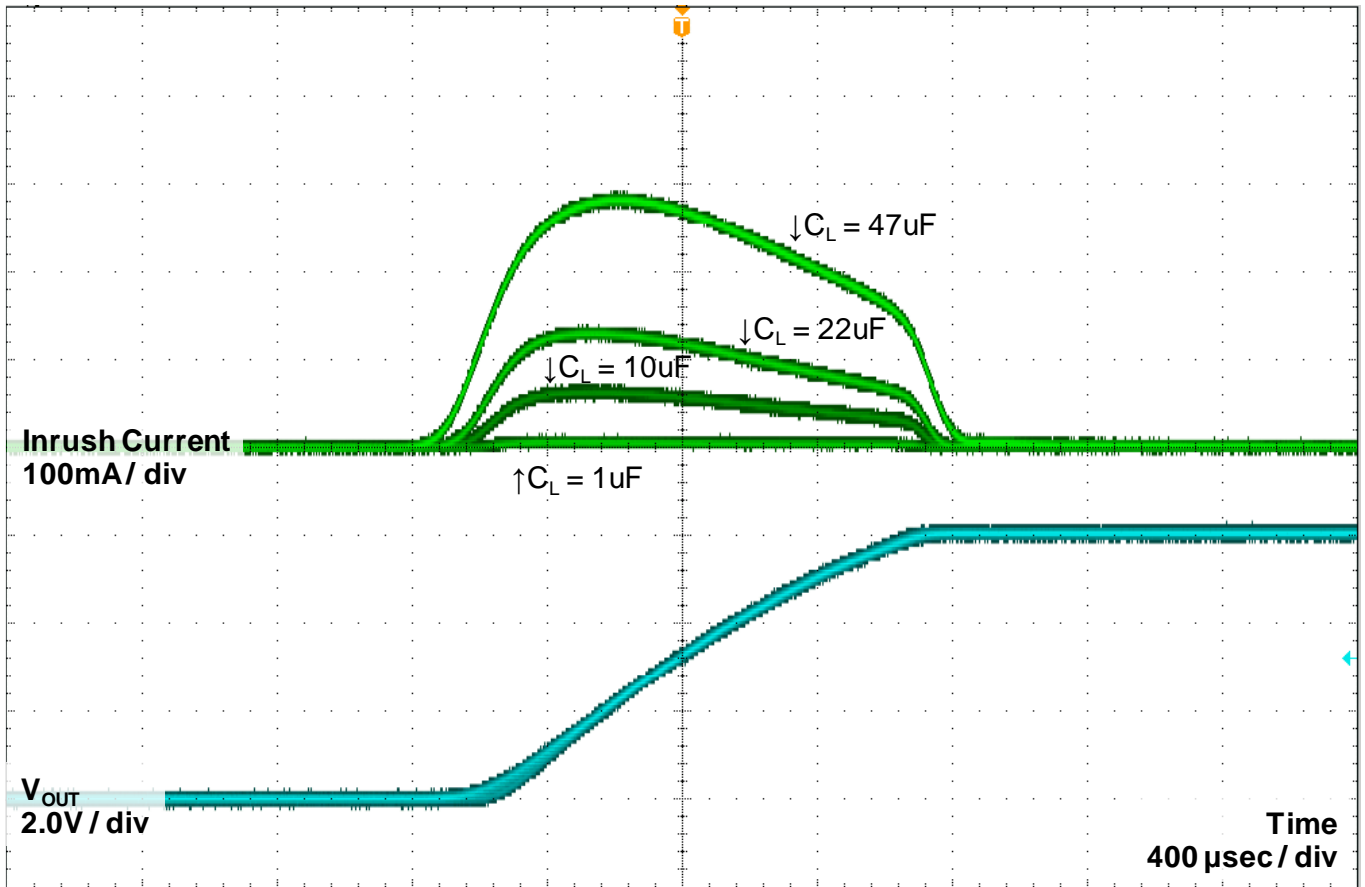

## ■ PACKAGING INFORMATION

For the latest package information go to, [www.torexsemi.com/technical-support/packages](http://www.torexsemi.com/technical-support/packages)

PACKAGE	OUTLINE / LAND PATTERN	THERMAL CHARACTERISTICS
USP-8B06	<a href="#">USP-8B06</a>	<a href="#">USP-8B06 Power Dissipation</a>

## MARKING RULE

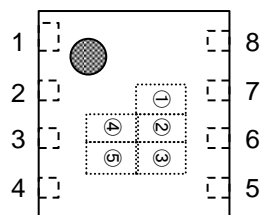

① represents product series.

MARK	PRODUCT SERIE
4	XC6194*****-G

② represents Type and Turn-On delay time

MARK	Type	Turn-On delay time	PRODUCT SERIE
0	Turn-on: By the SW pin Shut-down: By the SW pin or the SHDN pin	0.2s.	XC6194AA****-G
1		1s.	XC6194A1****-G
2		3s.	XC6194A3****-G
3		5s.	XC6194A5****-G
4	Turn-on: By the SW pin Shut-down: By the SHDN pin	0.2s.	XC6194BA****-G
5		1s.	XC6194B1****-G
6		3s.	XC6194B3****-G
7		5s.	XC6194B5****-G

③ represents Turn-Off delay time.

MARK	Turn-Off delay time	PRODUCT SERIE
A	3s.	XC6194**03**-G
B	5s.	XC6194**05**-G
C	10s.	XC6194**10**-G
D	15s.	XC6194**15**-G
0	-	XC6194B*NN**-G

④,⑤ represents production lot number

01~09, 0A~0Z, 11~9Z, A1~A9, AA~AZ, B1~ZZ in order.

(G, I, J, O, Q, W excluded)

\* No character inversion used.

1. The product and product specifications contained herein are subject to change without notice to improve performance characteristics. Consult us, or our representatives before use, to confirm that the information in this datasheet is up to date.
2. The information in this datasheet is intended to illustrate the operation and characteristics of our products. We neither make warranties or representations with respect to the accuracy or completeness of the information contained in this datasheet nor grant any license to any intellectual property rights of ours or any third party concerning with the information in this datasheet.
3. Applicable export control laws and regulations should be complied and the procedures required by such laws and regulations should also be followed, when the product or any information contained in this datasheet is exported.
4. The product is neither intended nor warranted for use in equipment of systems which require extremely high levels of quality and/or reliability and/or a malfunction or failure which may cause loss of human life, bodily injury, serious property damage including but not limited to devices or equipment used in 1) nuclear facilities, 2) aerospace industry, 3) medical facilities, 4) automobile industry and other transportation industry and 5) safety devices and safety equipment to control combustions and explosions. Do not use the product for the above use unless agreed by us in writing in advance.
5. Although we make continuous efforts to improve the quality and reliability of our products; nevertheless Semiconductors are likely to fail with a certain probability. So in order to prevent personal injury and/or property damage resulting from such failure, customers are required to incorporate adequate safety measures in their designs, such as system fail safes, redundancy and fire prevention features.
6. Our products are not designed to be Radiation-resistant.
7. Please use the product listed in this datasheet within the specified ranges.
8. We assume no responsibility for damage or loss due to abnormal use.
9. All rights reserved. No part of this datasheet may be copied or reproduced unless agreed by Torex Semiconductor Ltd in writing in advance.

TOREX SEMICONDUCTOR LTD.

# Mouser Electronics

Authorized Distributor

Click to View Pricing, Inventory, Delivery & Lifecycle Information:

[Torex Semiconductor:](#)

[XC6194B5NNER-G](#) [XC6194A110ER-G](#) [XC6194A115ER-G](#) [XC6194B115ER-G](#) [XC6194B303ER-G](#)  
[XC6194B3NNER-G](#) [XC6194B503ER-G](#) [XC6194A310ER-G](#) [XC6194B310ER-G](#) [XC6194A315ER-G](#) [XC6194AA03ER-](#)  
[G](#) [XC6194AA10ER-G](#) [XC6194BA05ER-G](#) [XC6194BANNER-G](#) [XC6194A510ER-G](#) [XC6194B510ER-G](#)  
[XC6194A103ER-G](#) [XC6194B103ER-G](#) [XC6194BA10ER-G](#) [XC6194A503ER-G](#) [XC6194B110ER-G](#) [XC6194B1NNER-](#)  
[G](#) [XC6194B315ER-G](#) [XC6194AA15ER-G](#) [XC6194BA15ER-G](#) [XC6194A515ER-G](#) [XC6194B515ER-G](#)  
[XC6194BA03ER-G](#) [XC6194AA05ER-G](#) [XC6194BANNE-EVB-01](#) [XC6194AA05E-EVB-01](#)