

TVS Diode

■ FEATURES

Terminal Capacitance	: 110pF
ESD Protection	: 25kV
Environmentally Friendly	: EU RoHS Compliant, Pb Free

■ APPLICATIONS

- Portable equipment

■ PIN CONFIGURATION

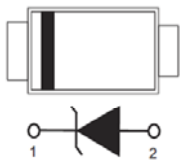

■ PACKAGING INFORMATION

- SOD-523P Unit: inch (mm)

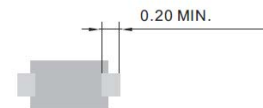
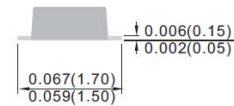
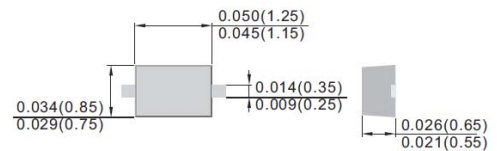

■ PRODUCT NAME

PRODUCT NAME	PACKAGE	ORDER UNIT
XBP1011-G *	SOD-523P	5,000 / Reel

* The "-G" suffix denotes Halogen and Antimony free as well as being fully RoHS compliant.

■ ABSOLUTE MAXIMUM RATINGS

Ta=25°C

PARAMETER	SYMBOL	RATINGS	UNITS
Peak Pulse Power (8/20 μs Waveform)	Ppk	120	W
Junction Temperature	Tj	-50 to 150	°C
Storage Temperature	Tstg	-50 to 150	°C

■ ELECTRICAL CHARACTERISTICS

Ta=25°C

PARAMETER	SYMBOL	TEST CONDITIONS	LIMITS			UNITS
			MIN.	TYP.	MAX.	
Stand-Off Voltage	V_{RWM}		-	-	5	V
Breakdown Voltage	V_{BR}	$I_R=1mA$	6.0	-	-	V
Leakage Current	I_R	$V_R=5V$	-	-	5	μA
Clamping Voltage (8/20 μs)	V_C	$I_{PP}=5A$	-	-	9	V
Terminal Capacitance	C_t	$V_R=0V, f=1MHz$	-	-	110	pF
		$V_R=5V, f=1MHz$	-	-	60	pF

■ NOTES ON USE

1. Please use this IC within the absolute maximum ratings.

Even within the ratings, in case of high load use continuously such as high temperature, high voltage, high current and thermal stress may cause reliability degradation of the IC.

2. Torex places an importance on improving our products and their reliability.

We request that users incorporate fail-safe designs and post-aging protection treatment when using Torex products in their systems.

■ REFERENCE PATTERN LAYOUT

● SOD-523P

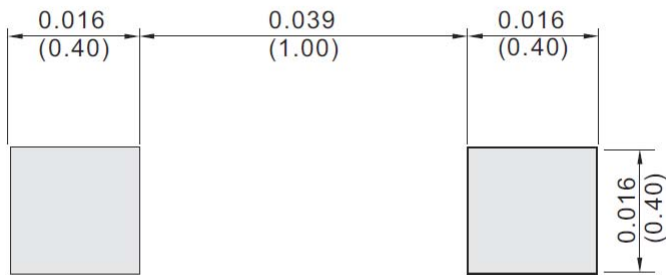

■ MARKING

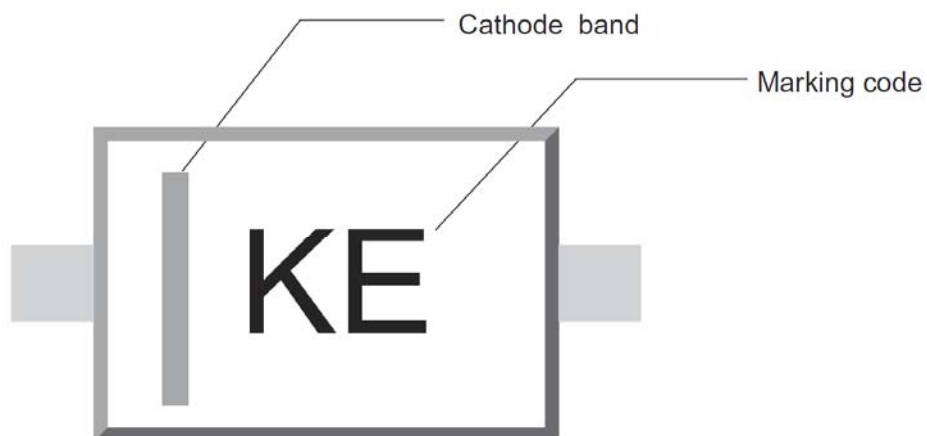

TAPING SPECIFICATIONS

●SOD-523P

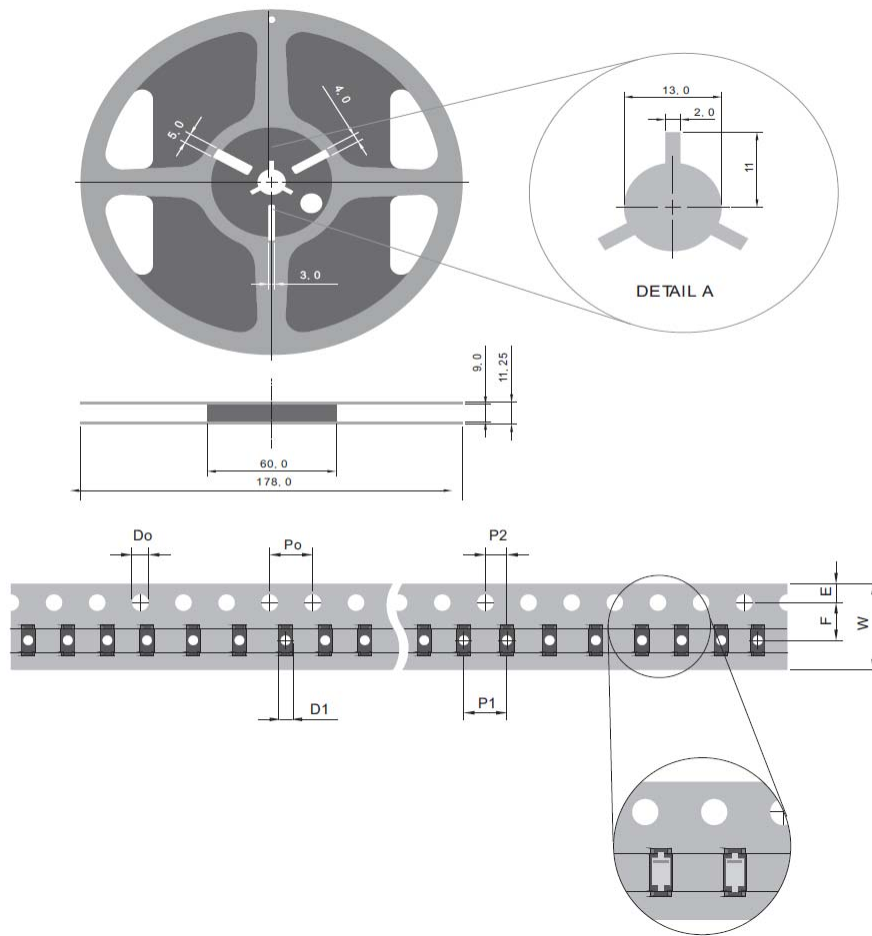

SYMBOL	mm
D0	1.50 ± 0.10
D1	0.50 ± 0.25
E	1.75 ± 0.10
F	3.50 ± 0.05
P0	4.00 ± 0.10
P1	4.00 ± 0.10
P2	2.00 ± 0.05
W	8.00 + 0.3 - 0.15

1. The products and product specifications contained herein are subject to change without notice to improve performance characteristics. Consult us, or our representatives before use, to confirm that the information in this datasheet is up to date.
2. We assume no responsibility for any infringement of patents, patent rights, or other rights arising from the use of any information and circuitry in this datasheet.
3. Please ensure suitable shipping controls (including fail-safe designs and aging protection) are in force for equipment employing products listed in this datasheet.
4. The products in this datasheet are not developed, designed, or approved for use with such equipment whose failure or malfunction can be reasonably expected to directly endanger the life of, or cause significant injury to, the user.
(e.g. Atomic energy; aerospace; transport; combustion and associated safety equipment thereof.)
5. Please use the products listed in this datasheet within the specified ranges.
Should you wish to use the products under conditions exceeding the specifications, please consult us or our representatives.
6. We assume no responsibility for damage or loss due to abnormal use.
7. All rights reserved. No part of this datasheet may be copied or reproduced without the prior permission of TOREX SEMICONDUCTOR LTD.

TOREX SEMICONDUCTOR LTD.

Mouser Electronics

Authorized Distributor

Click to View Pricing, Inventory, Delivery & Lifecycle Information:

[Torex Semiconductor:](#)

[XBP1011-G](#)