

Product range catalog

Switching and protecting motors

Build it in.



EATON

Powering Business Worldwide



We make what matters work.*



At Eaton, we believe that power is a fundamental part of just about everything people do. That's why we're dedicated to helping our customers find new ways to manage electrical, hydraulic and mechanical power more efficiently, safely and sustainably. To improve people's lives, the communities where we live and work, and the planet our future generations depend upon. Because this is what really matters. And we're here to make sure it works.

To learn more go to: [Eaton.com/whatmatters](https://www.eaton.com/whatmatters)

EATON

Powering Business Worldwide

[We make what matters work.](#)

Table of Contents

Moeller™ series

	Page
CAD data, online catalog	4
Product highlights	6
Mini contactors, contactor relays, contactors	1/0
Mini contactors	1/5
Contactor relays	1/14
DILM, DILMH, DILMP contactors	1/20
DILMS safety contactors	1/50
DILK contactors for capacitors	1/54
Lighting contactors DILL	1/56
Star-delta combinations SDAINL	1/58
DIUL reversing combinations	1/62
Accessories	1/66
Engineering	1/92
Technical data	1/103
Dimensions	1/150
Overload relay	2/0
Overload relay ZE, ZB, Z5 and CT-operated overload relay ZW7	2/6
ZEB Electronic overload relay	2/14
Motor-protective circuit breaker	3/0
PKZM01, PKZM0, PKZM4 motor-protective circuit breakers	3/3
PKE electronic motor-protective circuit breaker	3/10
Insulated enclosure for surface and flush mounting	3/20
MSF power feed system	3/30
Busbar adapter BBA	3/32
Technical data	3/48
Dimensions	3/55
Motor-starter combinations	4/0
DOL starter – complete devices MSC-D	4/2
DOL starter – modules PKM0, NZM, DILM, ZEB, ZB	4/12
Reversing starters – complete devices MSC-R	4/28
Reversing starters – modules PKZM, DILM, NZM	4/30
Starter on busbar adapter	4/34
DOL starter type E, type F	4/40
Technical data, dimensions	4/46
DC switchgear, network and system protection	5/0
DILDC DC contactors	5/3
Fireman's switch SOL30...-SAFETY	5/4
NAS network and system protection	5/5
P-SOL, PKZ-SOL DC switchgear	5/6
Service and support	
Worldwide export of machines and plants	6/0
Value-added services	6/2
Contact to Eaton	6/3

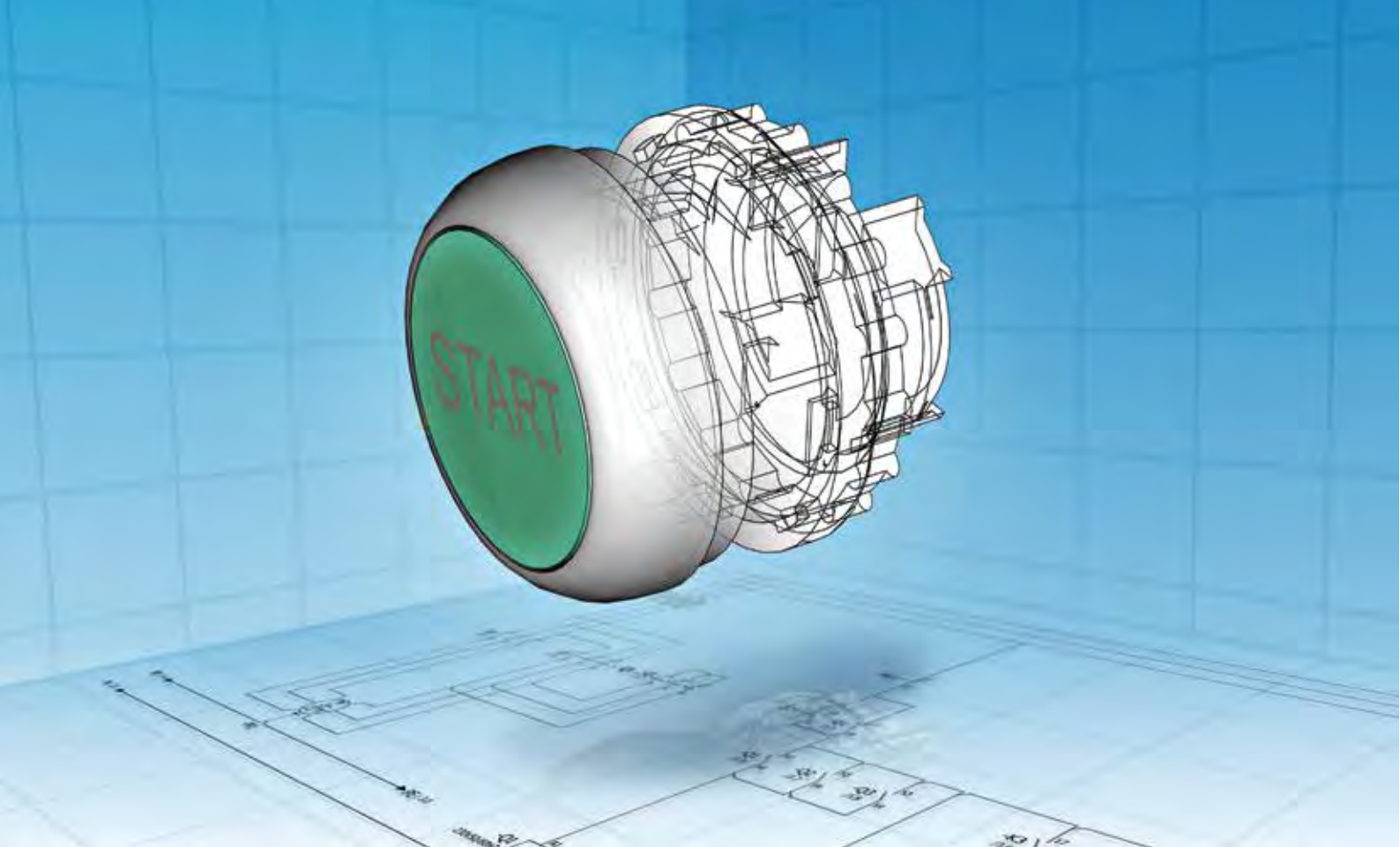

Planning safety and process optimization – CAD data at the push of a button!



- 13,200 article data and macros
- Convenient selection tool
- Version P8

Eaton is providing its customers with CAD data to offer optimum support during planning. Both electrical and mechanical design data can be called up quickly and conveniently from the Internet at any time. This reduces processing times, minimizes errors and thus reduces costs already in the engineering phase of control panels, systems and machinery.



- Models for approx. 11,000 products
- 80 different neutral and native formats

eCAD: Eaton makes product data and macros available for the EPLAN planning system and the Electric P8 version. After downloading the small selection program, EPLANSelection, the required article can be selected from the database which contains more than 10,800 products, exported and then imported into the customer's own EPLAN article database.

mCAD: Eaton provides 2D and 3D data for around 11,000 products. Over 80 different neutral and native formats guarantee compatibility with the project engineering systems of the customer. The models can either be integrated directly into the planning software from the Partcommunity Portal on the Internet or via the CADENAS Partsolution software.



www.eaton.eu/cad

Flip catalog: Get Information, Choose, Order – The Fast and Easy Way!



The product overview is used to quickly select the Eaton core range for mechanical engineering. This product overview is available online as a digital flip catalog with extensive additional functions. This makes obtaining information and ordering much easier and quicker.

How does our digital flip catalog work? The contents of the digital flip catalog are linked with the Eaton online catalog and the product pages on the internet: Click on the type designation or article number to access all the product information directly. In other words, the flip catalog is the perfect way to obtain comprehensive, up-to-date information, perfectly complementing our hard copy catalog.



Product highlights

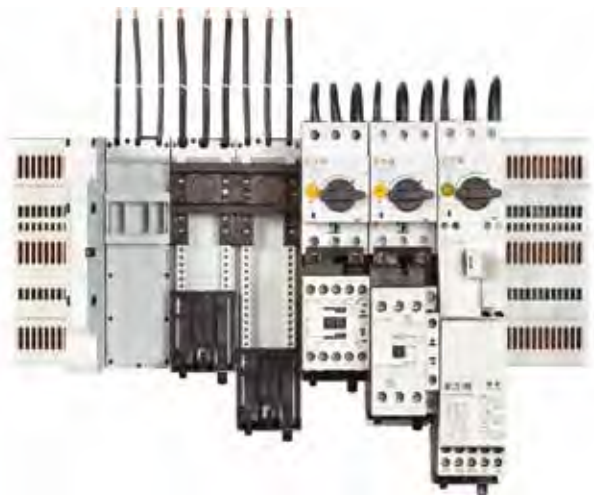

Feeder system: Power feed system for motor-starter combinations

The feeder system forms the basis for safe and innovative energy distribution of up to 125 A. The modular solution can be simply and intuitively integrated in your machines and systems with pluggable assembly.

Out-Of-The-Box: The feeder system can be assembled with ease: Fast, simple and reliable - out of the box and directly into the control panel! All the components are assembled without the need for tools, and the snap-lock-technology enables an easy feed to the system.

Discover more on Page 3/30.

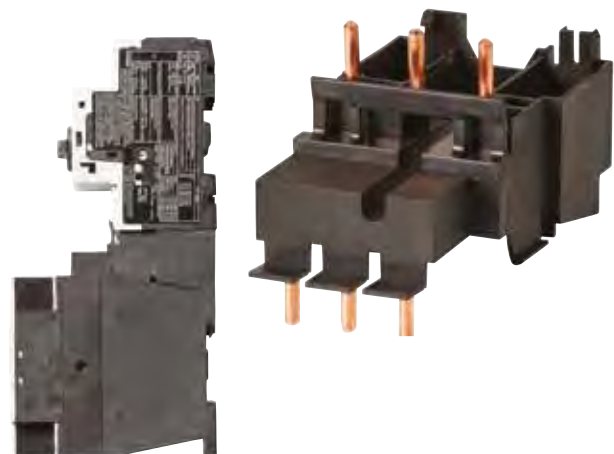

Link module PKZ — DIL

Motor-starter combinations with up to 15 kW power rating, consisting of a motor-protective circuit breaker and a contactor, can now be built with improved time-saving properties and a more compact design using the new link module PKZM0-XDM32ME.

The link module enables the electromechanical combination of motor-protective circuit breakers PKZM0, PKE12 and PKE32 with the contactors DILM17 to DILM38 and/or the soft starters DS7 in the rated current range of 16 to 32 A. The link module can be used to fit DOL starters or reversing starters.

Discover more on Page 3/35



DILMS safety contactors up to 150 A/75 kW

A safety contactor must comply with the requirement "unintended misuse".

In other words

- Reliable status monitoring of a contactor
- Reliable switching off for a controlled stop
- Interlocked auxiliary contact elements
- Mirror contacts
- Signal with low power

Discover more on Page 1/52.

DILDC contactors

The DILDC contactors of the Moeller® series for the current range 300 A to 600 A (DC) can be used in various applications. The proven hybrid technology ensures a high lifespan of the devices.

Compared with similar DC contactors, the Eaton contactors have a much higher electrical operation. The DILDC contactors will therefore become a maintenance-free and reliable component in every machine and system.

Discover more on Page 5/3.

Build it in.



DIL contactors: Powerful, efficient and flexible



The DIL contactor series covers the entire output range from mini contactor relays up to 7 A through to vacuum contactors up to 3180 A. The combination with electronic overload relays or bimetal relays supports motor starters for the most varied of applications.

The safety contactor series up to 150 A/75 kW with auxiliary contact blocks fitted to the front complies with the requirements for unintended misuse.

All devices fulfill the demands for world-wide use and are compliant to UL/CSA, CCC and shipping classifications. The motor protection systems are also ATEX certified.

The contactors are even more efficient primarily due to the eco types for 15.5 A, 38 A, 72 A and 170 A as well as the many innovations for the motor starters, such as SmartWire-DT.

DILM contactors up to 170 A



The DILM contactor series up to 170 A is characterized by its compact dimensions. Accordingly, all AC- and DC-operated devices have the same dimensions and can therefore use the same auxiliary equipment, which makes engineering easier for you.

All contactors with DC actuation from DILM17 or higher feature an electronically controlled coil unit with the following features:

- Significantly less heat dissipation due to reduced sealing power
- Small control transformers due to low pull-in power
- Direct actuation from the PLC without coupling relays up to 38 A.

DILMS safety contactors up to 150 A / 75 kW



A safety contactor must enable manipulation-proof operation. The DILMS safety contactors from Eaton comply with the following requirements:

- Reliable statusmonitoring of a contactor
- Reliable switching off for a controlled stop
- Interlocked auxiliary contact elements
- Mirror contacts
- Signal with lowpower

The front coil end enables the operator simple troubleshooting and a reliable commissioning. The yellow color of the DILMS safety contactor distinguishes it from the normal contactors.

Contactors of greater output up to 3180 A



All DILM and DILH contactors in the range from 185 A to 3180 A have electronically controlled coils. This results in the following advantages for the application:

- Flexibility in the actuation (classically directly from the PLC or via low-power actuating device)
- Considerably lower control panel temperatures due to reduced sealing power
- Broad control voltage tolerance for a greater reliability in the case of voltage fluctuations
- Integrated suppressor circuit
- In the comfort version, four wide-range actuating voltages cover the entire control voltage range from 48 V to 500 V.

The DILM contactors from 580 A and DILH from 1400 A are vacuum contactors with the following additional features:

- High electrical lifespan
- No open arc. They can therefore be fitted together more closely (switching gases do not blow out).



1.0 Mini contactor relays, contactor relays, contactors

Mini contactors

1.1 System overview	1/5
DILER, DILE(E)M contactors	1/5
1.2 Product selection	1/6
DILER contactor relay	1/6
DILE(E)M contactors	1/8
DILE auxiliary contact modules	1/10
Accessories	1/12

Contactor relays

DILA	1/14
DILA...XHI... auxiliary contact modules	1/16
DILAS safety contactor relays	1/18

Contactors

1.3 Technical overview	1/20
1.4 System overview	1/22
DILM7 – DILM170	1/22
DILM185A – DILH2600	1/23
1.5 Product selection	1/24
DILM basic devices up to 170 A	1/24
DILMC basic devices up to 150 A	1/28
DILM complete devices up to 150 A	1/30
DILMF contactors up to 150 A with electronic actuation	1/34
DILM standard devices greater than 170 A	1/36
DILM comfort devices greater than 170 A	1/38
DILH comfort devices greater than 170 A	1/40
4 pole DILMP contactors up to 200 A	1/42
DILM...XHI..., DILA...XHI... auxiliary contact modules	1/44
1.6 Engineering	1/49
Auxiliary contact modules for DILM, DILH	1/49
1.7 Product selection	1/50
DILMS safety contactors up to 150 A	1/50
DILK contactors for capacitors	1/54
1.8 Engineering	1/55
DILM, DILK contactors for power factor correction	1/55
1.9 Product selection	1/56
DILL lighting contactors	1/56
1.10 Engineering	1/57
DILL, DILM contactors for lighting systems	1/57
1.11 Product selection	1/58
SDAINL star-delta combinations	1/58
1.12 Engineering	1/60
SDAINL star-delta combinations	1/60
1.13 Product selection	1/62
DIUL reversing combinations	1/62

DILM



1.0	Contactor relays, contactors	
	DILM...-XSP... suppressor circuits	1/64
	Accessories	1/66
	Contactor monitoring device CMD	
1.14	Product selection	1/78
1.15	Engineering	1/79
	Diagrams	1/79
	Mini contactors	
1.16	Product selection	1/80
	DILER, DILEEM actuating voltages	1/80
	DILEM actuating voltages	1/81
	Contactor relays	
	DILA actuating voltages	1/82
	Contactors	
	DILM7 – DILM15 actuating voltages	1/83
	DILM17 – DILM38 actuating voltages	1/84
	DILM40 – DILM225A actuating voltages	1/85
	DILMC7 – DILMC95 actuating voltages	1/86
	DILMP actuating voltages	1/87
	DILM...-XSP(...) actuating voltages	1/88
	DILK, DILMF actuating voltages	1/89
	DILM7 – DILM820 actuating voltages DILM...XSP/E... complete devices	1/90
	DIUL, SDAINL actuating voltages	1/91
1.17	Engineering	1/92
	DILA, DILE, DILH, DILM contact travel diagrams	1/92
	DILE, DILM, DIUL, SDAINL enclosure	1/93
	DILEM, DILM, DILH contactors for resistive load	1/94
	Mini contactor relays, contactor relays	
	DILA, DILER electrical lifespan	1/96
	Contactors	
	DILEM, DILM electrical lifespan/switching duties	1/97
	DILEM, DILM, DILH electrical lifespan/switching duties	1/98
	DILMP electrical lifespan/switching duties	1/99
	DILEM, DILM, DILH short-time loading	1/100
	DILEM, DILM, DILH operating frequency	1/101
	DILEM, DILM, DILMP switching DC current	1/102

DILM185A



1.18 Technical Data	1/103
Mini contactor relays, contactor relays	
DILA, DILER	1/103
Contactors	
Amplifier module, electronic timer modules, contactor monitoring device	1/106
Mini contactors	
DILEEM, DILEM	1/109
Contactors	
DILM(S) basic devices up to 170 A	1/114
DILM185A – DILM1600, DILH	1/124
DILMP	1/134
DILK contactors for capacitors	1/138
DILL lighting contactors	1/140
DILMF	1/142
Auxiliary contact	1/148
Paralleling link	1/149
1.19 Dimensions	1/150
DILER..., DILE(E)M..., DIULEM	1/150
DILM..., DILA..., DILMF..	1/151
DILMP..	1/153
DILM...	1/154
DILM..., DILH...	1/155
DILK..., DILL..., CMD, DIL-SWD	1/156
SDAINL..., DIUL...	1/157
Accessories	1/158

System overview

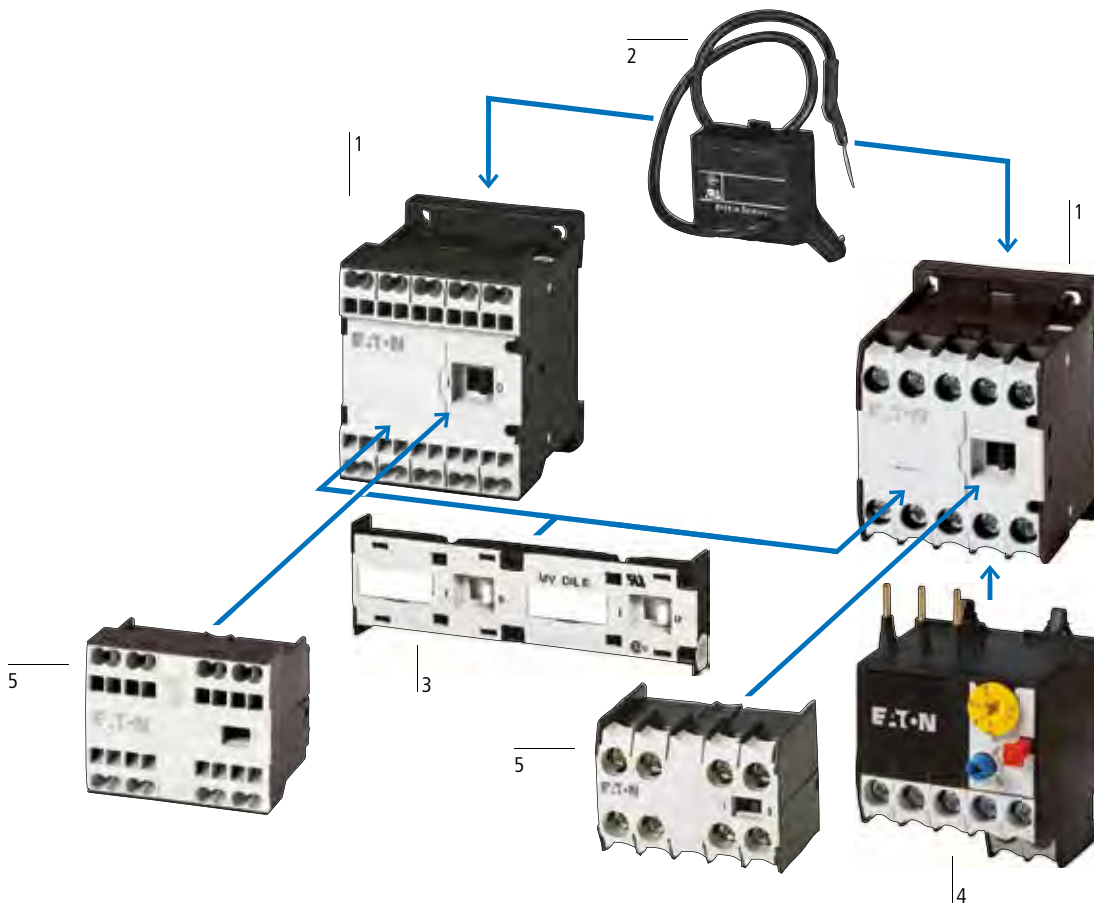

Mini contactors	1
Screw terminals	
→ Page 1/8	
Spring-loaded terminals	
→ Page 1/8	
Suppressor circuits	2
→ Page 1/12	
Mechanical interlock	3
→ Page 1/12	
Motor protection relay	4
→ Page 1/12	
Auxiliary contact modules	5
→ Page 1/10	

1

Product Selection

Rated operational current			Conventional thermal current 1-pole at 50 °C open	Contact configuration		Distinctive number	Circuit symbol	For use with
220 V	380 V	500 V		N/O = normally open	N/C = normally closed contact			
220 V	380 V	500 V	I_e					
230 V	400 V							
240 V	415 V							
I_e	I_e	I_e	$I_{th} = I_e$					
A	A	A	A					

Auxiliary contactor relay DILER

with interlocked opposing contacts

Screw terminals

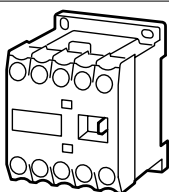

6	3	1.5	10	4 N/O	–	40E		...DILE ¹⁾
				3 N/O	1 N/C	31E		
				2 N/O	2 N/C	22E		

Spring-loaded terminals

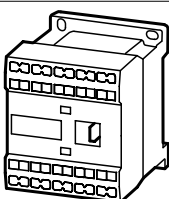

6	3	1.5	10	4 N/O	–	40E		...DILE-C ¹⁾
				3 N/O	1 N/C	31E		
				2 N/O	2 N/C	22E		

Notes

Coil terminal marking to EN 50005.
Contacts according to EN 50011.
For DC operated contactors:
Integrated diode-resistor combination.
Coil rating 2.6 W.

¹⁾ Not in conjunction with DILER-22-G(24VDC)/
DILER-22-G-C(24VDC)

Information relevant for export to North America



Product standards

UL File No.
UL CCN
CSA File No.
CSA Class No.
NA Certification

IEC/EN 60947-4-1; UL 508; CSA-C22.2
No. 14-05; CE marking
E29184
NKCR
012528
3211-03
UL listed, CSA certified

AC operation	DC operation		
Type	Type	Std. pack	Notes
Article no.	Article no.		

DILER-40(230V50HZ,240V60HZ) 051759	DILER-40-G(24VDC) 010223
DILER-31(230V50HZ,240V60HZ) 051768	DILER-31-G(24VDC) 010157
DILER-22(230V50HZ,240V60HZ) 051777	DILER-22-G(24VDC) 010042

5 pcs.

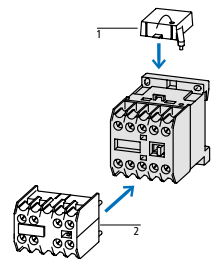
Accessories	Page
1 Suppressor	→ 1/12
2 Auxiliary contact module	→ 1/10
Further actuating voltages	→ 1/80

DILER-40-C(230V50HZ,240V60HZ) 230239	DILER-40-G-C(24VDC) 230241
DILER-31-C(230V50HZ,240V60HZ) 230178	DILER-31-G-C(24VDC) 230179
DILER-22-C(230V50HZ,240V60HZ) 230176	DILER-22-G-C(24VDC) 230177

5 pcs.

Accessories	Page
1 Suppressor	→ 1/12
2 Auxiliary contact module	→ 1/10
Further actuating voltages	→ 1/80

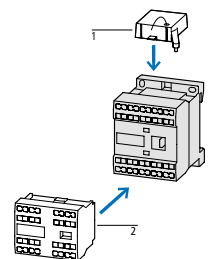
DILE(E)M contactors

1

Rated operational current	max. Motor rating						Conventional thermal current 3 pole, 50 - 60 Hz AC-1 at 40 °C open	Contact configuration	
	Three-phase motors 50-60 Hz							N/O = normally open	N/C = normally closed contact
	AC-3		AC-3		AC-4				
	380 V	220 V	380 V	660 V	220 V	380 V	660 V		
	400 V	230 V	400 V	690 V	230 V	400 V	690 V		
I_e		P	P	P	P	P	P	$I_{th} = I_e$	
A		kW	kW	kW	kW	kW	kW	A	

DILE(E)M contactors

Screw terminals

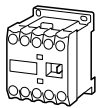

3 pole, with auxiliary contact



6.6	1.5	3	3	1.1	2.2	2.2	22	1 N/O	–	
–	–	–	–	–	–	–	–	–	1 N/C	
9	2.2	4	4	1.5	3	3	22	1 N/O	–	
–	–	–	–	–	–	–	–	–	1 N/C	
–	12	3	5.5	4	1.5	3	3	22	1 N/O	
–	–	–	–	–	–	–	–	–	1 N/C	
4-pole	–	9	2.2	4	4	1.5	3	3	22	–
–	–	–	–	–	–	–	–	–	–	–

Spring-loaded terminals

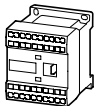

3 pole, with auxiliary contact



6.6	1.5	3	3	1.1	2.2	2.2	22	1 N/O	–
–	–	–	–	–	–	–	–	–	1 N/C
9	2.2	4	4	1.5	3	3	22	1 N/O	–
–	–	–	–	–	–	–	–	–	1 N/C

Notes

AC-1: Non-inductive or slightly inductive loads, resistance furnaces
 AC-3: Normal AC induction motors: Starting, switching off while running
 AC-4: Normal AC induction motors: Starting, using counter-current for braking, reversing, inching



Also suitable for motors with efficiency class IE3.
 IE3-ready devices are identified by the logo on their packaging.

Information relevant for export to North America



Product standards

UL File No.
 UL CCN
 CSA File No.
 CSA Class No.
 NA Certification

IEC/EN 60947-4-1; UL 508;
 CSA-C22.2 No. 14-05; CE marking
 E29096
 NLDX
 012528
 3211-04
 UL listed, CSA certified

AC operation

DC operation

Type
Article no.

Type
Article no.

Std. pack Notes

Circuit symbol For use with

	...DILEM ...DILE	DILEEM-10(230V50HZ,240V60HZ) 051608	DILEEM-10-G(24VDC) 051643	5 pcs. 	
	...DILE	DILEEM-01(230V50HZ,240V60HZ) 051633	DILEEM-01-G(24VDC) 051650		
	...DILEM ...DILE	DILEEM-10(230V50HZ,240V60HZ) 051786	DILEEM-10-G(24VDC) 010213		
	...DILE	DILEEM-01(230V50HZ,240V60HZ) 051795	DILEEM-01-G(24VDC) 010343		
	...DILEM ...DILE	DILEEM12-10(230V50HZ,240V60HZ) 127075	DILEEM12-10-G(24VDC) 127132		
	...DILE	DILEEM12-01(230V50HZ,240V60HZ) 127091	DILEEM12-01-G(24VDC) 127137		
	...DILEM ...DILE	DILEEM4(230V50HZ,240V60HZ) 051804	DILEEM4-G(24VDC) 012701		
	...DILEM-C ...DILE-C	DILEEM-10-C(230V50HZ,240V60HZ) 230042	DILEEM-10-G-C(24VDC) 230052	5 pcs. 	
	...DILE-C	DILEEM-01-C(230V50HZ,240V60HZ) 230135	DILEEM-01-G-C(24VDC) 230155		
	...DILEM-C ...DILE-C	DILEEM-10-C(230V50HZ,240V60HZ) 230164	DILEEM-10-G-C(24VDC) 230165		
	...DILE-C	DILEEM-01-C(230V50HZ,240V60HZ) 230166	DILEEM-01-G-C(24VDC) 230167		

Accessories	Page
1 Overload relays	→ 2/8
2 Suppressor	→ 1/12
3 Auxiliary contact module	→ 1/10
Enclosure totally insulated	
Accessories	→ 1/12
Further actuating voltages	→ 1/81

Accessories	Page
1 Suppressor	→ 1/12
2 Auxiliary contact module	→ 1/10
Enclosure totally insulated	
Accessories	→ 1/12
Further actuating voltages	→ 1/81

DILE auxiliary contact modules

1

Poles	Rated operational current			Contact configuration	Distinctive number/type of combinations		
	AC-15				with basic device		
	220 V	380 V	500 V	N/O = normally open NO _e : NO early-make N/C = normally closed contact NC _i =NC late-break	DILER-40(-G)	DILER-31(-G)	DILER-22
	230 V	400 V					
	240 V	415 V					
	I _e	I _e	I _e				
	A	A	A				

Auxiliary contact modules

Front-mounting auxiliary contacts

Front mounting

Interlocked opposing contacts according to IEC/EN 60947-5-1 appendix L, inside the auxiliary contact modules, also for the integrated auxiliary contacts of the basic devices (not NC late-break, not NO early-make)

Auxiliary contacts used as mirror contacts according to IEC/EN 60947-4-1 Appendix F (not NC late-break)



Screw terminals

Poles	4	2	1.5									
2-pole				-	-	2 N/C	-	-	-	-		
						1 N/O	-	1 N/C	-	-		
4-pole						2 N/O	-	2 N/C	-	-		
2-pole						-	-	2 N/C	-	42E	33	24
						1 N/O	-	1 N/C	-	51E	42	33
						2 N/O	-	-	-	60E	51	42
						-	1 N/O _E	-	1 N/C _L	51	42	33
						-	-	4 N/C	-	44E	35	26
						1 N/O	-	3 N/C	-	53E	44	35
4-pole						2 N/O	-	2 N/C	-	62E	53	44
						3 N/O	-	1 N/C	-	71E	62	53
						4 N/O	-	-	-	80E	71	62
						1 N/O	1 N/O _E	1 N/C	1 N/C _L	62	53	44



Spring-loaded terminals





2-pole	4	2	1.5	1 N/O	-	1 N/C	-	-	-	-
4-pole				2 N/O	-	2 N/C	-	-	-	-
2-pole				1 N/O	-	1 N/C	-	51E	42	33
4-pole				-	-	4 N/C	-	44E	35	26
				1 N/O	-	3 N/C	-	53E	44	35
				2 N/O	-	2 N/C	-	62E	53	44
				3 N/O	-	1 N/C	-	71E	62	53
				4 N/O	-	-	-	80E	71	62
				1 N/O	1 N/O _E	1 N/C	1 N/C _L	62	53	44

Notes

Information relevant for export to North America

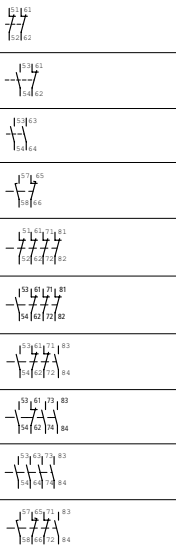

Product Standards	IEC/EN 60947-4-1; UL 508; CSA-C22.2 No. 14-05; CE marking
UL File No.	E29184
UL CCN	NKCR
CSA File No.	012528
CSA Class No.	3211-03
NA Certification	UL listed, CSA certified

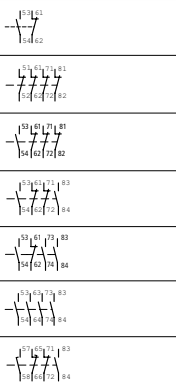
Circuit symbol	for use with	Type Article no.	Std. pack	Notes
	DILEM-10(-G)(...) DILEM-4(-G)(...) DILEEM-10(-G)(...) DILEM12-10(-G)(...)	02DILEM 010064 11DILEM 010080 22DILEM 010112	5 pcs. 	The following applies to ...DILEM auxiliary contacts: Switching elements according to EN 50012 The following applies to ...DILE auxiliary contacts: Switching elements according to EN 50005
	DILEM-10(-G)(...) DILEM-01(-G)(...) DILEM-4(-G)(...) DILER40(-G) DILER31(-G) DILER22 DILEEM-10(-G)(...) DILEEM-01(-G)(...) DILEM12-10(-G)(...) DILEM12-01(-G)(...)	02DILE 010240 11DILE 010224 20DILE 010208 11DDILE 049824 04DILE 010256 13DILE 002397 22DILE 010288 31DILE 048912 40DILE 010304 22DDILE 049823		Switching elements according to EN 50012 are to be preferred. E version combinations comply with EN 50011 and must be given preference.
	DILE(E)M-10-C(-G)(...)	11DILEM-C 230255 22DILEM-C 230256	5 pcs. 	
	DILE(E)M-10-C(-G)(...) DILE(E)M-01-C(-G)(...) DILER40(-G)-C DILER31(-G)-C DILER22-C	11DILE-C 230257 04DILE-C 230258 13DILE-C 230259 22DILE-C 230260 31DILE-C 230262 40DILE-C 230263 22DDILE-C 230264		

Operating voltage Contact sequence For use with **Type** Article no. Std. pack **Information relevant for export to North America**



U_s
V AC



Suppressor circuits

For AC operation contactors 50 - 60 Hz.
The suppressor is fitted as standard in DC operated contactor relays.
Note drop-out delay

varistor suppressor

24 - 48		DILE...	VG DILE48 010320	10 pcs. 	Product standards UL File No. UL CCN CSA File No. CSA Class No. NA Certification	IEC/EN 60947-4-1; UL 508; CSA-C22.2 No. 14-05; CE marking E29096 NLDX 012528 3211-03 UL Listed, CSA certified
48 - 130			VG DILE130 150681			
110 - 250			VG DILE250 010336			
380 - 415			VG DILE415 010463			
24 - 48		DILE...C	VG DILE48-C 230265			
48 - 130			VG DILE130-C 150682			
110 - 250			VG DILE250-C 230266			

RC suppressor

24 - 48		DILE...	RC DILE48 044264	10 pcs. 	Product standards UL File No. UL CCN CSA File No. NA Certification	IEC/EN 60947-4-1; UL 508; CSA-C22.2 No. 14-05; CE marking E29184 NKCR2 - UL recognized
48 - 130			RC DILE130 150679			
110 - 250			RC DILE250 046320			
24 - 48			DILE...C			
48 - 130			RC DILE130-C 150680			
110 - 250			RC DILE250-C 230268			



Connectors

For mechanical connection of contactor, relays and timing relays in combinations.
Contactor distance: 0 mm

-	-	DILE... DILET...	VO DILE 026634	50 pcs. 	UL/CSA certification not required
---	---	---------------------	--------------------------	-------------	-----------------------------------

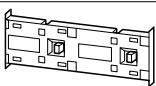

Mechanical interlock

For contactors with the same or different magnet system.
Contactor distance: 0 mm
Mechanical lifespan: 2.5×10^6 operations.
Additional auxiliary contact modules possible.

-		DILE...	MV DILE 010113	5 pcs. 	Product standards UL File No. UL CCN CSA File No. CSA Class No. NA Certification	IEC/EN 60947-4-1; UL 508; CSA-C22.2 No. 14-05; CE marking E29184 NKCR2 012528 3211-07 UL-recognized, CSA-certified
---	--	---------	--------------------------	------------	---	--

Parallel connector

For parallel connection of contacts

-	-	DILE... ...DILE	BT480 ¹⁾ 052785	100 pcs. 	Product standards UL File No. UL CCN CSA File No. CSA Class No. NA Certification	IEC/EN 60947-4-1; UL 508; CSA-C22.2 No. 14-05; CE marking E29096 NLDX 012528 3211-07 UL Listed, CSA certified
consisting of two 4 pole paralleling links						
-		DILEEM DILEM12 DILEM	PI DILEM ²⁾ 019095	5 pcs. 		

Notes

¹⁾ Not protected against accidental contact as specified in VDE 0106 Part 100.







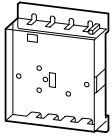

²⁾ 4. Pole can be broken off

4-pole: $I_{th} = 60$ A open

3-pole: $I_{th} = 50$ A open

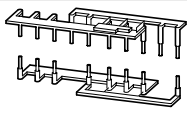
AC-1 current carrying capacity of the open contactor increases by a factor of 2.5.

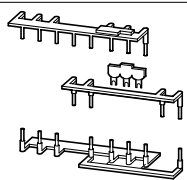
Protected against accidental contact in accordance to VDE 0106 part 100

	For use with	Type Article no.	Std. pack	Information relevant for export to North America 	
	sealable shroud				
	Transparent Snap-fitting on contactor. Can be used with open installation or in installation distributor. Protection type: IP40 front. Can be drilled to accommodate timing relay setting dials.				
	DILE... DILET...	HDILE 010482	1 pc. 	UL/CSA certification not required	
	star-point bridge				
	 DILEEM DILEM12 DILEM	S1DILEM¹⁾ 220218	20 pcs.		
	reversing wiring kit				
	Main current wiring for reversing combinations				
	DILEEM (+MVDILEM) DILEM12 (+MVDILEM) DILEM (+MVDILEM)	MVS-WB-EM²⁾ 220209	1 pc. 	Product standards UL File No. UL CCN CSA File No. CSA Class No. NA Certification	IEC/EN 60947-4-1; UL 508; CSA-C22.2 No. 14-05; CE marking E36332 NLRV7 012528 3211-06 UL Listed, CSA certified
	star-delta wiring kit				
	Main current wiring for star-delta combination incl. star-point bridge				
	DILE(E)M mains contactor DILE(E)M delta contactor DILE(E)M star contactor	MVS-SB-EM³⁾ 220213	1 pc. 	Product standards UL File No. UL CCN CSA File No. CSA Class No. NA Certification	IEC/EN 60947-4-1; UL 508; CSA-C22.2 No. 14-05; CE marking E36332 NLRV7 012528 3211-06 UL Listed, CSA certified
Notes	¹⁾ Protected against accidental contact in accordance with VDE 0106 Part 100. ²⁾ The following control cables are integrated in addition to electrical interlock: Q11: A1 - Q12: 21 Q11: 21 - Q12: A1 Q11: A2 - Q12: A2 For use with overload relay separate mounting. ³⁾ The following control cables are integrated in addition to electrical interlock: Q13: A1 - Q15: 21 Q13: 21 - Q15: A1 Q13: A2 - Q15: A2 For use with overload relay separate mounting.				

DILA

1

Rated operational current			Conventional thermal current 1-pole, at 60 °C open	Distinctive number	Contact configuration		can be combined with auxiliary contact module	Circuit symbol
220 V	380 V	500 V			N/O = normally open	N/C = normally closed contact		
220 V	380 V	500 V						
230 V	400 V							
240 V	415 V							
I_e	I_e	I_e	$I_{th} = I_e$					
A	A	A	A					

Basic devices

with interlocked opposing contacts

Screw terminals

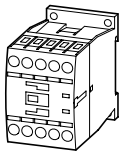

4	4	1.5	16	40E	4 N/O	–	DILA-XHI(V)...	
				31E	3 N/O	1 N/C	DILA-XHI(V)...	
				22E	2 N/O	2 N/C	DILA-XHI(V)...	

Spring-loaded terminals

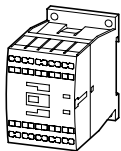

4	4	1.5	16	40E	4 N/O	–	DILA-XHIC(V)...	
				31E	3 N/O	1 N/C	DILA-XHIC(V)...	
				22E	2 N/O	2 N/C	DILA-XHIC(V)...	

Notes

Contact numbers to EN 50011
Coil terminal markings to EN 50005
For DC operated contactors: integrated suppressor circuit

Information relevant for export to North America



Product standards	IEC/EN 60947-4-1; UL 508; CSA-C22.2 No. 14-05; CE marking
UL File No.	E29184
UL CCN	NKCR
CSA File No.	012528
CSA Class No.	3211-03
NA Certification	UL Listed, CSA certified

AC operation

Type
Article no.

Std. pack

Circuit symbol

DC operation

Type
Article no.

Std. pack

Notes

DILA-40(230V50HZ,240V60HZ)
276329

1 pc.

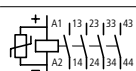

DILA-40(24VDC)
276344

1 pc.

DILA-31(230V50HZ,240V60HZ)
276364

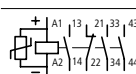

DILA-31(24VDC)
276379

DILA-22(230V50HZ,240V60HZ)
276399

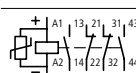

DILA-22(24VDC)
276414

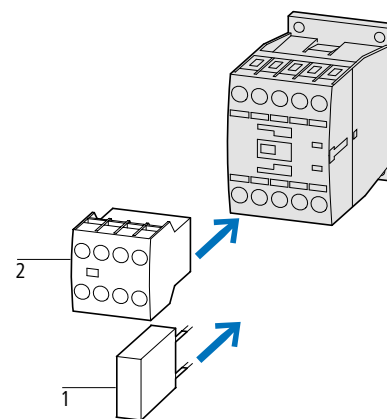

Accessories

- 1 Suppressor
- 2 Auxiliary contact module
- Further actuating voltages

Page

- 1/64
- 1/16
- 1/14

DILAC-40(230V50HZ,240V60HZ)
276441

1 pc.

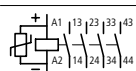

DILAC-40(24VDC)
276456

1 pc.

DILAC-31(230V50HZ,240V60HZ)
276473

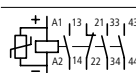

DILAC-31(24VDC)
276488

DILAC-22(230V50HZ,240V60HZ)
276505

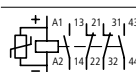

DILAC-22(24VDC)
276520

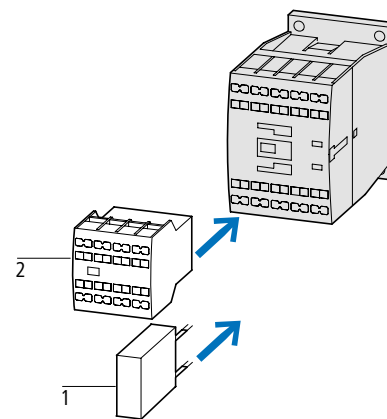

Accessories

- 1 Suppressor
- 2 Auxiliary contact module
- Further actuating voltages

Page

- 1/64
- 1/16
- 1/14

in conjunction with SmartWire-DT module → Page 1/72

Poles	Rated operational current AC-15			Conventional thermal current 1-pole at 60 °C open	Contact configuration N/O = normally open NO _E : NO early-make N/C = normally closed contact NC _L =NC late-break
	220 V	380 V	500 V		
	230 V	400 V			
	240 V	415 V			
	I _e	I _e	I _e	I _{th} = I _e	
	A	A	A	A	

Auxiliary contact modules

Front-mounting auxiliary contacts

Front mounting

Interlocked opposing contacts according to IEC/EN 60947-5-1 appendix L, inside the auxiliary contact modules, also for the integrated auxiliary contacts of the basic devices (not NC late-break, not NO early-make)

Auxiliary contacts used as mirror contacts according to IEC/EN 60947-4-1 Appendix F (not NC late-break)

Screw terminals



2-pole	4	4	1.5	16	-	-	2 N/C	-
					1 N/O	-	1 N/C	-
					2 N/O	-	-	-
					-	1 N/O _E	-	1 N/C _L



4-pole					-	-	4 N/C	-
					1 N/O	-	3 N/C	-
					2 N/O	-	2 N/C	-
					3 N/O	-	1 N/C	-
					4 N/O	-	-	-
					1 N/O	1 N/O _E	1 N/C	1 N/C _L

Spring-loaded terminals



2-pole	4	4	1.5	16	-	-	2 N/C	-
					1 N/O	-	1 N/C	-
					2 N/O	-	-	-
					-	1 N/O _E	-	1 N/C _L



4-pole					-	-	4 N/C	-
					1 N/O	-	3 N/C	-
					2 N/O	-	2 N/C	-
					3 N/O	-	1 N/C	-
					4 N/O	-	-	-
					1 N/O	1 N/O _E	1 N/C	1 N/C _L

Notes

Information relevant for export to North America



Product standards	IEC/EN 60947-4-1; UL 508; CSA-C22.2 No. 14-05; CE marking
UL File No.	E29184
UL CCN	NKCR
CSA File No.	012528
CSA Class No.	3211-03
NA Certification	UL listed, CSA certified

Distinctive number/type of combinations with basic device			Circuit symbol	For use with	Type	Std. pack	Notes
DILA(C)-40	DILA(C)-31	DILA(C)-22					
42E	33	24		DILA... DILM(C)7... DILM(C)9... DILM(C)12... DILM(C)15... DILM(C)17... DILM(C)25... DILM(C)32... DILM38... DILMP20... DILMP32... DILMP45... DILL... DILMF8... DILMF11... DILMF14... DILMF17... DILMF25... DILMF32...	DILA-XHI02¹⁾ 276420	5 pcs. 	¹⁾ Version E combinations correspond to EN 50011 and are to be preferred. Other combinations correspond to EN 50005. The DC operated contactor DILA(C)-22 must only be combined with 2 pole auxiliary contacts.
51E	42	33			DILA-XHI11¹⁾ 276421		
60E	51	42			DILA-XHI20¹⁾ 276422		
51	42	33			DILA-XHIV11 276423		
44E	35	26			DILA-XHI04¹⁾ 276424		
53E	44	35			DILA-XHI13¹⁾ 276425		
62E	53	44			DILA-XHI22¹⁾ 276426		
71E	62	53			DILA-XHI31¹⁾ 276427		
80E	71	62			DILA-XHI40¹⁾ 276428		
62	53	44			DILA-XHIV22¹⁾ 276429		
42E	33	24		DILA... DILM(C)7... DILM(C)9... DILM(C)12... DILM(C)15... DILM(C)17... DILM(C)25... DILM(C)32... DILM38... DILMP20... DILMP32... DILMP45... DILL... DILMF8... DILMF11... DILMF14... DILMF17... DILMF25... DILMF32...	DILA-XHIC02¹⁾ 276526	5 pcs. 	
51E	42	33			DILA-XHIC11¹⁾ 276527		
60E	51	42			DILA-XHIC20¹⁾ 276528		
51	42	33			DILA-XHICV11 276529		
44E	35	26			DILA-XHIC04¹⁾ 276530		
53E	44	35			DILA-XHIC13¹⁾ 276531		
62E	53	44			DILA-XHIC22¹⁾ 276532		
71E	62	53			DILA-XHIC31¹⁾ 276533		
80E	71	62			DILA-XHIC40¹⁾ 276534		
62	53	44			DILA-XHICV22¹⁾ 276535		

DILAS safety contactor relays

1

Rated operational current		Conventional thermal current 1-pole at 60 °C	Type of current AC/DC
AC-15			Contact configuration
220 V	380 V	500 V	N/O = normally open
230 V	400 V		N/C = normally closed contact
240 V	415 V		
I_e	I_e	I_e	
A	A	A	

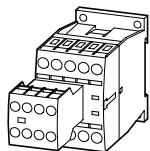

DILAS safety contactor relays

Screw terminals

Basic devices and top mounting auxiliary contacts with interlocked opposing contacts

4	4	1.5	4 N/O	4 N/C	AC operation
					DC operation with integrated suppressor circuit

Basic devices and top mounting auxiliary contacts with interlocked opposing contacts (except for microswitches)
2 electronically compatible auxiliary contacts based on microswitches (1 N/O + 1 N/C)

4	4	1.5	4 N/O	4 N/C	AC operation
					DC operation with integrated suppressor circuit

Notes

Contacts according to EN 50011.
Coil terminal marking to EN 50005.

Information relevant for export to North America



Product standards
NA Certification

IEC/EN 60947-4-1; UL 508; CSA-C22.2 No. 14-05; CE marking
Request filed for UL and CSA

Operating voltage	Circuit symbol	Type Article no.	Std. pack
110 V 50 Hz, 120 V 60 Hz		DILAS-44(110V50HZ,120V60HZ) 191700	1 pc.
230 V 50 Hz, 240 V 60 Hz		DILAS-44(230V50HZ,240V60HZ) 191739	
24 V DC		DILAS-44(24VDC) 191760	
110 V 50 Hz, 120 V 60 Hz		DILAS-R44(110V50HZ,120V60HZ) 191732	1 pc.
230 V 50 Hz, 240 V 60 Hz		DILAS-R44(230V50HZ,240V60HZ) 191753	
24 V DC		DILAS-R44(24VDC) 191720	

Technical overview

Contactors

3-pole

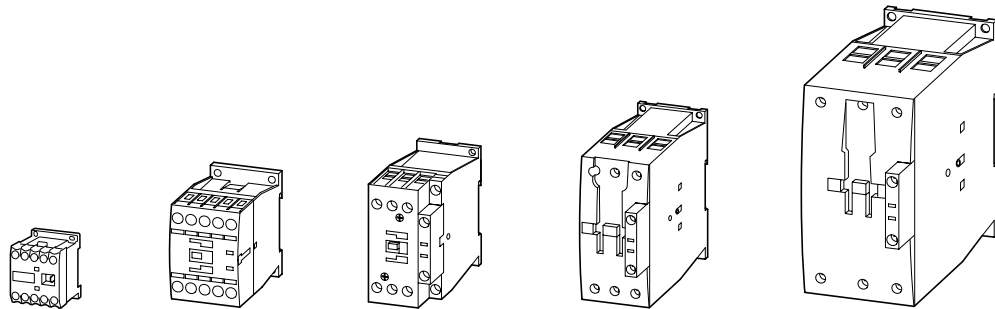

DIL...	EEM	EM	EM12	M7	M9	M12	M15	M17	M25	M32	M38	M40	M50	M65	M72	M80	M95	M115	M150	M170
Basic devices	Page	→ 1/8		→ 1/24				→ 1/24				→ 1/26				→ 1/26				
Complete units	Page	-		→ 1/30			-	→ 1/30				→ 1/32				→ 1/32				
Rated operating voltage		kW	kW	kW	kW	kW	kW	kW	kW	kW	kW	kW	kW	kW	kW	kW	kW	kW	kW	kW

AC-3

Motor rating for three-phase motors, 50 - 60 Hz

220 V - 230 V	1.5	2.2	3	2.2	2.5	3.5	4	5	7.5	10	11	12.5	15.5	20	22	25	30	37	48	52
380 V - 400 V	3	4	5.5	3	4	5.5	7.5	7.5	11	15	18.5	18.5	22	30	37	37	45	55	75	90
440 V	3	4	5.5	4.5	5.5	7.5	8.4	10.5	15.5	20	21	25	32	41	44	51	60	75	95	105
500 V	3	4	5.5	3.5	4.5	7	7.5	12	17.5	23	24	28	36	47	50	58	70	85	110	120
660 V/690 V	3	4	4	3.5	4.5	6.5	7	11	14	17	21	23	30	35	35	63	75	90	96	96
1000 V	-	-	-	-	-	-	-	-	-	-	-	-	-	-	-	-	-	-	-	-

AC-4

Motor rating for three-phase motors, 50 - 60 Hz

▲ Increase in life span for DILM7 – DILM150 to 200.000 operations

220 V - 230 V	1.1	1.5	1.5	1	1.5	2	2	2.5	3.5	4	4	5	6	7	7	11.5	16	17	20	20
380 V - 400 V	2.2	3	3	2.2	2.5	3	3	4.5	6	7	7	9	10	12	12	20	26	28	33	33
440 V	2.4	3.3	3	2.4	3	3.6	3.6	5.5	7	8	8	10	12	14	14	25	32	35	41	41
500 V	2.2	3	3	2.5	2.8	3.5	3.5	6	8	9	9	11	13	16	16	29	36	40	47	47
660 V/690 V	2.2	3	3	2.9	3.6	4.4	4.4	6.5	8.5	10	10	12	14	17	17	26	35	43	48	48
1000 V	-	-	-	-	-	-	-	-	-	-	-	-	-	-	-	-	-	-	-	-

AC-1

Rated operational power under resistive load, 40 °C

220 V - 230 V	8	8	8	8	8	8	8	15	17	17	17	22	30	37	37	42	49	61	72	85
380 V - 400 V	13	13	13	14	14	14	14	26	29	29	29	39	53	65	65	72	85	105	125	150
440 V	15	15	15	16	16	16	16	30	34	34	34	45	58	71	71	80	94	116	138	170
500 V	18	18	18	19	19	19	19	34	38	38	38	51	66	81	81	90	107	132	156	194
660 V/690 V	23	23	23	25	25	25	25	45	51	51	51	68	91	111	111	125	148	182	216	268
1000 V	-	-	-	-	-	-	-	-	-	-	-	-	-	-	-	-	-	-	-	-
Conventional thermal Current $I_{th} = I_e$ open at 40 °C	A	A	A	A	A	A	A	A	A	A	A	A	A	A	A	A	A	A	A	A
	22	22	22	22	22	22	22	40	45	45	45	60	80	98	98	110	130	160	190	225

Contactors

4-pole

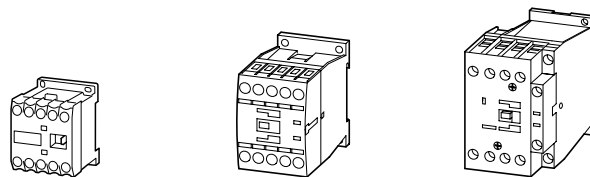

	DIL	EM4	MP20	MP32
Basic devices	Page	→ 1/8	→ 1/42	→ 1/42
AC-1				
Conventional thermal current $I_{th} = I_e$ open at 40 °C		A	A	A
Up to 690 V		22	22	32

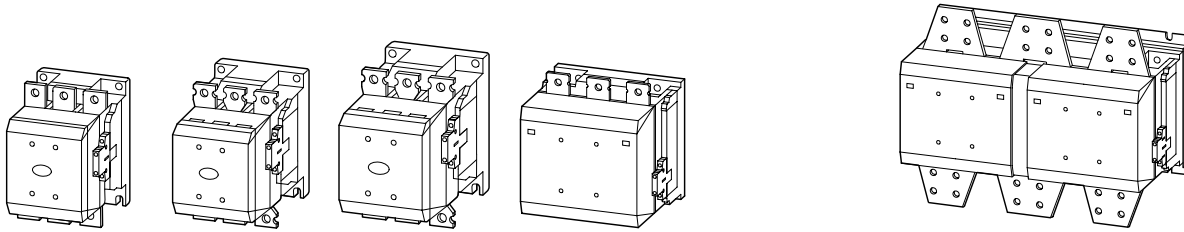

M185A	M225A	M250	M300A	M400	M500	M580	M650	M750	M820	M1000	M1600	H1200	H1400	H2000	H2200	H2600
→ 1/38											→ 1/40					
kW	kW	kW	kW	kW	kW	kW	kW	kW	kW	kW	kW	kW	kW	kW	kW	kW

55	70	75	90	125	155	185	205	240	260	315	500	-	-	-	-	-
90	110	132	160	212	265	315	355	400	450	560	900	-	-	-	-	-
115	138	152	185	250	315	370	420	480	450	650	1000	-	-	-	-	-
132	160	173	210	280	355	420	470	550	600	730	1180	-	-	-	-	-
140	150	170	170	300	300	560	630	720	750	1000	1600	-	-	-	-	-
108	108	108	132	132	132	600	600	800	800	1100	1770	-	-	-	-	-

41	51	62	75	92	112	143	161	181	209	260	430	-	-	-	-	-
75	90	110	132	160	200	250	280	315	355	450	750	-	-	-	-	-
85	102	125	150	186	229	290	326	367	418	520	830	-	-	-	-	-
96	116	138	170	210	250	330	370	417	474	590	940	-	-	-	-	-
102	110	137	137	240	240	440	494	556	633	780	1300	-	-	-	-	-
77	77	108	108	132	132	509	509	678	678	1000	1650	-	-	-	-	-

121	139	155	177	221	310	354	376	398	443	443	717	527	620	886	1075	1269
210	241	268	306	382	535	612	650	689	766	766	1247	910	1071	1531	1870	2207
243	279	310	354	443	620	709	753	797	886	886	1371	1054	1240	1773	2058	2427
277	317	352	403	503	705	806	856	906	1007	1007	1558	1198	1410	2015	2338	2758
365	419	465	532	664	930	1064	1130	1196	1330	1330	2151	1582	1861	2660	3227	3806
554	635	705	806	1007	1410	1612	1712	1813	2015	2015	2420	2054	2417	3223	4676	5516
A	A	A	A	A	A	A	A	A	A	A	A	A	A	A	A	A

337	386	430	490	612	800	980	1041	1102	1225	1225	2200	1450	1714	2450	2700	3185
-----	-----	-----	-----	-----	-----	-----	------	------	------	------	------	------	------	------	------	------

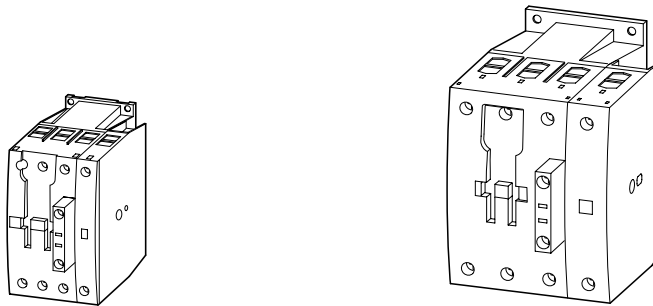

MP45	MP63	MP80	MP125	MP160	MP200
→ 1/42	→ 1/42		→ 1/42		
A	A	A	A	A	A
45	63	80	125	160	200

1

System overview

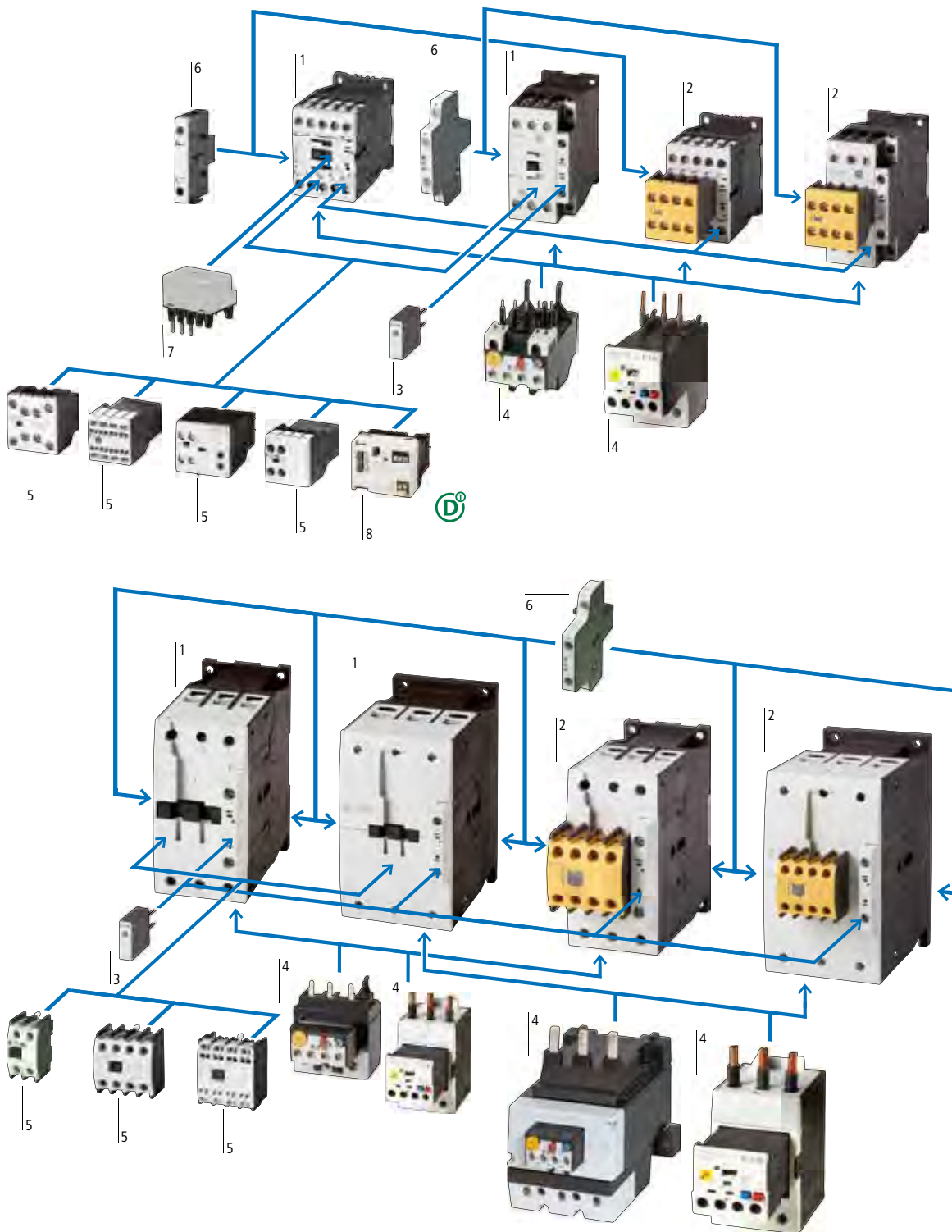

Contactors up to 90 kW (AC-3/400 V) 1

3-pole

→ Page 1/26

4-pole

→ Page 1/42

Safety contactors up to 75 kW (AC-3/400 V) 2

3-pole

→ Page 1/50

Suppressor circuits 3

→ Page 1/64

Motor protection relay 4

→ Page 2/10

Auxiliary contact modules 5

→ Page 1/47

Side mounting auxiliary contact modules 6

→ Page 1/48

Motor suppressor module 7

→ Page 1/72

SmartWire-DT contactor module 8

→ Page 1/72

System overview

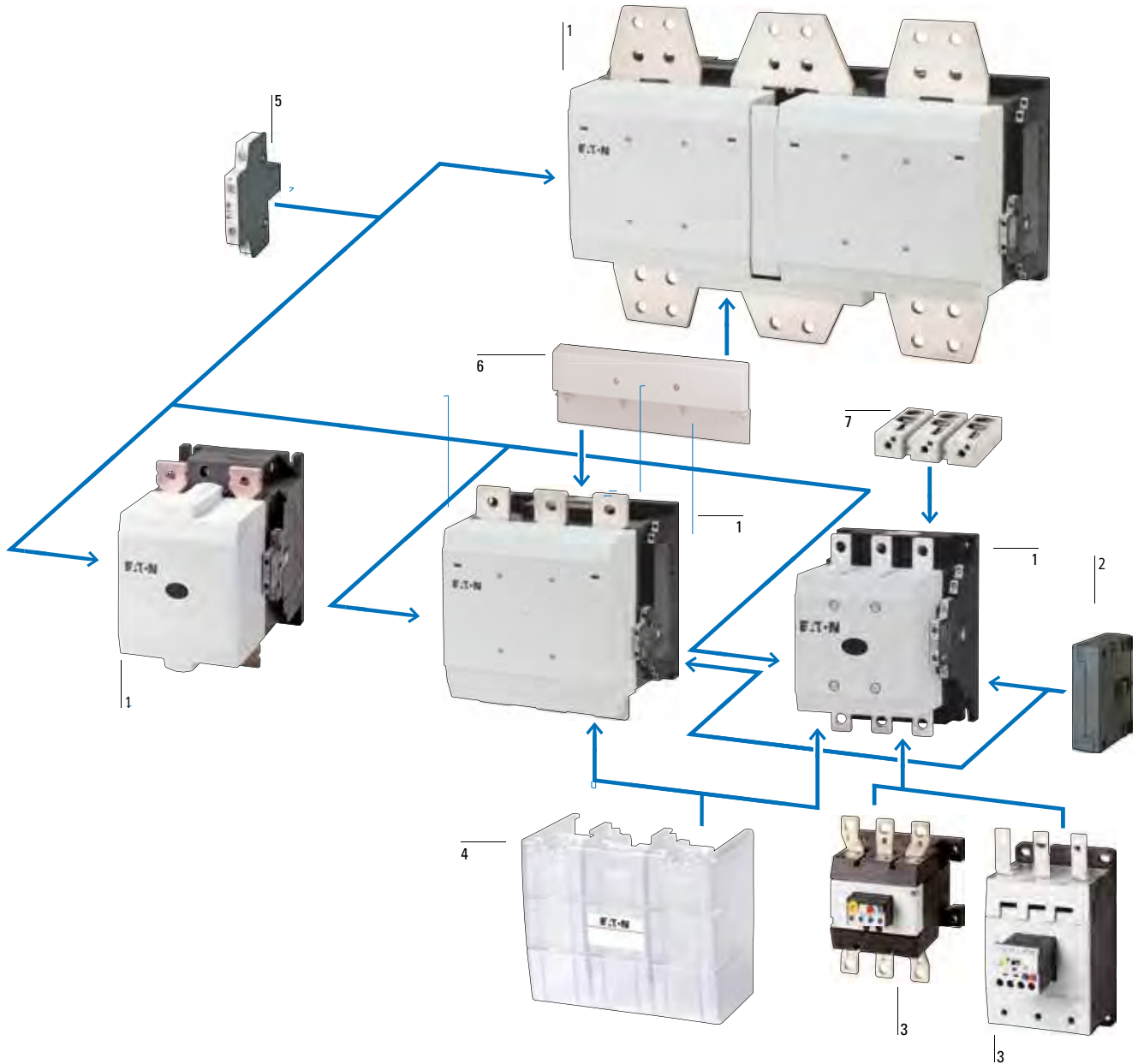

Contactors 90 - 900 kW (AC-3/400 V)	1
Comfort range	
→ Page 1/38	
Standard range 90 - 250 kW (AC-3/400 V)	1
→ Page 1/36	
DC contactors 300 - 600 A (DC-1/1000 VDC)	1
→ Page 5/3	
Mechanical interlock	2
→ Page 1/66	
Motor protection relay	3
→ Page 2/12	

Terminal cover	4
→ Page 1/74	
Auxiliary contact modules	5
→ Page 1/48	
Suppressor circuit	6
→ Page 1/74	
cable terminal block	7
→ Page 1/73	

Product Selection

Rated operational current AC-3	max. Motor rating three-phase motors 50 - 60 Hz						Conventional thermal current 3-pole AC-1 at 40 °C open $I_{th} = I_e$ A	Contact assembly N/O = normally open N/C = normally closed contact	Contact sequence
	AC-3			AC-4					
380 V 400 V	220 V 230 V	380 V 400 V	660 V 690 V	220 V 230 V	380 V 400 V	660 V 690 V			
I_e A	P kW	P kW	P kW	P kW	P kW	P kW			

Basic devices

Screw terminals

3 pole, with auxiliary contact

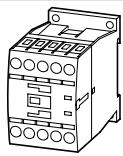

IE3 ✓	7	2.2	3	3.5	1	2.2	2.9	22	1 N/O	–	
	7	2.2	3	3.5	1	2.2	2.9	22	–	1 N/C	
	9	2.5	4	4.5	1.5	2.5	3.6	22	1 N/O	–	
	9	2.5	4	4.5	1.5	2.5	3.6	22	–	1 N/C	
	12	3.5	5.5	6.5	2	3	4.4	22	1 N/O	–	
	12	3.5	5.5	6.5	2	3	4.4	22	–	1 N/C	
	–	15.5	4	7.5	7	2	3	4.4	22	1 N/O	–
–	15.5	4	7.5	7	2	3	4.4	22	–	1 N/C	
IE3 ✓	18	5	7.5	11	2.5	4.5	6.5	40	1 N/O	–	
	18	5	7.5	11	2.5	4.5	6.5	40	–	1 N/C	
	25	7.5	11	14	3.5	6	8.5	45	1 N/O	–	
	25	7.5	11	14	3.5	6	8.5	45	–	1 N/C	
	32	10	15	17	4	7	10	45	1 N/O	–	
	32	10	15	17	4	7	10	45	–	1 N/C	
	–	38	11	18.5	21	4	7	10	45	1 N/O	–
–	38	11	18.5	21	4	7	10	45	–	1 N/C	

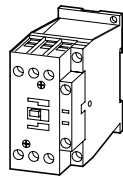

Notes

Information relevant for export to North America



Product standards
UL File No.
UL CCN
CSA File No.
CSA Class No.
NA Certification

IEC/EN 60947-4-1; UL 60947-4-1; CSA-C22.2 No. 60947-4-1-14; CE marking
E29096
NLDX
012528
2411-03, 3211-04
UL Listed, CSA certified



Also suitable for motors with efficiency class IE3.
IE3-ready devices are identified by the logo on their packaging.

Can be combined with auxiliary contact	AC operation	DC operation	Std. pack	Notes
	Type Article no.	Type Article no.		

DILM32-XHI... DILA-XHI(V)...	DILM7-10(230V50HZ,240V60HZ) 276550	DILM7-10(24VDC) 276565	 1 pc.  
DILA-XHI(V)...	DILM7-01(230V50HZ,240V60HZ) 276585	DILM7-01(24VDC) 276600	
DILM32-XHI... DILA-XHI(V)...	DILM9-10(230V50HZ,240V60HZ) 276690	DILM9-10(24VDC) 276705	
DILA-XHI(V)...	DILM9-01(230V50HZ,240V60HZ) 276725	DILM9-01(24VDC) 276740	
DILM32-XHI... DILA-XHI(V)...	DILM12-10(230V50HZ,240V60HZ) 276830	DILM12-10(24VDC) 276845	
DILA-XHI(V)...	DILM12-01(230V50HZ,240V60HZ) 276865	DILM12-01(24VDC) 276880	
DILM32-XHI... DILA-XHI(V)...	DILM15-10(230V50HZ,240V60HZ)¹⁾ 290058	DILM15-10(24VDC)¹⁾ 290073	
DILA-XHI(V)...	DILM15-01(230V50HZ,240V60HZ)¹⁾ 290093	DILM15-01(24VDC)¹⁾ 290108	
DILM32-XHI... DILA-XHI(V)...	DILM17-10(230V50HZ,240V60HZ) 277004	DILM17-10(RDC24) 277018	
DILM32-XHI11-S	DILM17-01(230V50HZ,240V60HZ) 277036	DILM17-01(RDC24) 277050	
DILM32-XHI... DILA-XHI(V)...	DILM25-10(230V50HZ,240V60HZ) 277132	DILM25-10(RDC24) 277146	
DILM32-XHI11-S	DILM25-01(230V50HZ,240V60HZ) 277164	DILM25-01(RDC24) 277178	
DILM32-XHI... DILA-XHI(V)...	DILM32-10(230V50HZ,240V60HZ) 277260	DILM32-10(RDC24) 277274	
DILM32-XHI11-S	DILM32-01(230V50HZ,240V60HZ) 277292	DILM32-01(RDC24) 277306	
DILM32-XHI... DILA-XHI(V)...	DILM38-10(230V50HZ,240V60HZ)¹⁾ 112428	DILM38-10(RDC24)¹⁾ 112442	
DILM32-XHI11-S	DILM38-01(230V50HZ,240V60HZ)¹⁾ 112456	DILM38-01(RDC24)¹⁾ 112470	

Contacts according to EN 50012.
For DC operated conductors DILM7 - DILM15 the following applies:
Integrated varistor suppressor circuit.
For DC operated conductors DILM17 - DILM170 the following applies:
Integrated suppressor circuit in actuating electronics.
For DILM7-01 – DILM38-01 the following applies:
With mirror contact.

¹⁾ Electrical lifespan → Page 1/97

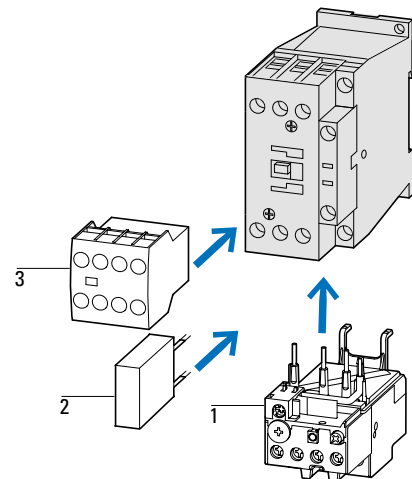

Accessories	Page
1 Overload relays	→ 2/8
2 Suppressor	→ 1/12
3 Auxiliary contact module	→ 1/44
Accessories	→ 1/66
Further actuating voltages	→ 1/84

 in conjunction with SmartWire-DT module → Page 1/72

DILM basic devices up to 170 A

1

Rated operational current	max. Motor rating three-phase motors 50 - 60 Hz						Conventional thermal current 3-pole AC-1 at 40 °C open	Contact assembly N/O = normally open N/C = normally closed contact
	AC-3			AC-4				
380 V 400 V	220 V 230 V	380 V 400 V	660 V 690 V	220 V 230 V	380 V 400 V	660 V 690 V	$I_{th} = I_e$	
I_e A	P kW	P kW	P kW	P kW	P kW	P kW	A	

Basic devices

Screw terminals

3-pole

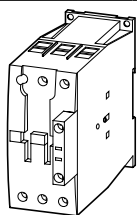

IE3 ✓	40	12.5	18.5	23	5	9	12	60	-	-
	50	15.5	22	30	6	10	14	80	-	-
	65	20	30	35	7	12	17	98	-	-
	72	22	37	35	7	12	17	98	-	-
IE3 ✓	80	25	37	63	12	20	26	110	-	-
	95	30	45	75	16	26	35	130	-	-
	115	37	55	90	17	28	43	160	-	-
	150	48	75	96	20	33	48	190	-	-
	170	52	90	96	20	33	48	225	-	-

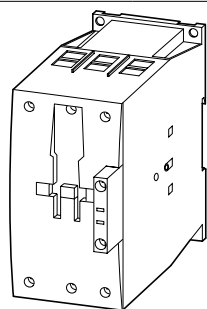

Notes

Information relevant for export to North America



Product standards
UL File No.
UL CCN
CSA File No.
CSA Class No.
NA Certification

IEC/EN 60947-4-1; UL 60947-4-1; CSA-C22.2 No. 60947-4-1-14; CE marking
E29096
NLDX
012528
2411-03, 3211-04
UL Listed, CSA certified



Also suitable for motors with efficiency class IE3.
IE3-ready devices are identified by the logo on their packaging.

Contact sequence	Can be combined with auxiliary contact	AC operation Type Article no.	DC operation Type Article no.	Std. pack	Notes
		DILM40(230V50HZ,240V60HZ) 277766	DILM40(RDC24) 277780	1 pc. 	Contacts according to EN 50012. For DC operated contactors DILM17 – DILM170 the following applies: Integrated suppressor circuit in actuating electronics. For AC operated contactors DILM115 – DILM170 the following applies: Integrated suppressor circuit in actuating electronics. ¹⁾ Electrical lifespan → Page 1/97
		DILM50(230V50HZ,240V60HZ) 277830	DILM50(RDC24) 277844		
		DILM65(230V50HZ,240V60HZ) 277894	DILM65(RDC24) 277908		
		DILM72(230V50HZ,240V60HZ)¹⁾ 107670	DILM72(RDC24)¹⁾ 107671		
		DILM80(230V50HZ,240V60HZ) 239402	DILM80(RDC24) 239416		
		DILM95(230V50HZ,240V60HZ) 239480	DILM95(RDC24) 239510		
		DILM115(RAC240) 239548	DILM115(RDC24) 239555		
		DILM150(RAC240) 239588	DILM150(RDC24) 239591		
		DILM170(RAC240)¹⁾ 107013	DILM170(RDC24)¹⁾ 107016		

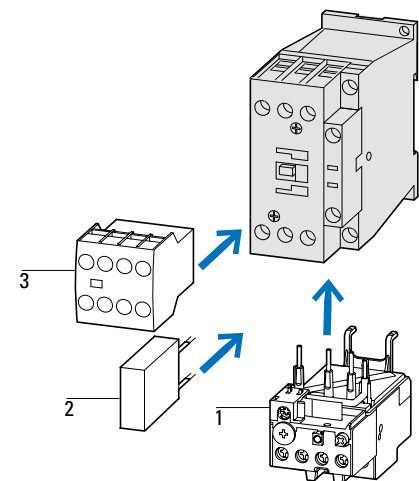

Accessories	Page
1 Overload relays	→ 2/8
2 Suppressor	→ 1/64
3 Auxiliary contact module	→ 1/44
Accessories	→ 1/66
Further actuating voltages	→ 1/83

DILMC basic devices up to 150 A

1

Rated operational current AC-3	max. Motor rating three-phase motors 50 - 60 Hz						Conventional thermal current 3-pole AC-1 at 40 °C open $I_{th} = I_e$ A	Contact assembly N/O = normally open N/C = normally closed contact	Contact sequence
	AC-3			AC-4					
380 V 400 V	220 V 230 V	380 V 400 V	660 V 690 V	220 V 230 V	380 V 400 V	660 V 690 V			
I_e A	P kW	P kW	P kW	P kW	P kW	P kW			

Basic devices

IE3 ✓

Spring-loaded terminals 3-pole

7	2.2	3	3.5	1	2.2	2.9	22	1 N/O	–		
7	2.2	3	3.5	1	2.2	2.9	22	–	1 N/C		
9	2.5	4	4.5	1.5	2.5	3.6	22	1 N/O	–		
9	2.5	4	4.5	1.5	2.5	3.6	22	–	1 N/C		
12	3.5	5.5	6.5	2	3	4.4	22	1 N/O	–		
12	3.5	5.5	6.5	2	3	4.4	22	–	1 N/C		
–	15.5	4	7.5	7	2	3	4.4	22	1 N/O	–	
–	15.5	4	7.5	7	2	3	4.4	22	–	1 N/C	

Spring-loaded terminals on auxiliary and control circuit terminals 3-pole

IE3 ✓

18	5	7.5	11	2.5	4.5	6.5	40	1 N/O	–	
18	5	7.5	11	2.5	4.5	6.5	40	–	1 N/C	
25	7.5	11	14	3.5	6	8.5	45	1 N/O	–	
25	7.5	11	14	3.5	6	8.5	45	–	1 N/C	
32	10	15	17	4	7	10	45	1 N/O	–	
32	10	15	17	4	7	10	45	–	1 N/C	

IE3 ✓

40	12.5	18.5	23	5	9	12	60	–	–	
50	15.5	22	30	6	10	14	80	–	–	
65	20	30	35	7	12	17	98	–	–	

IE3 ✓

80	25	37	63	12	20	26	110	–	–	
95	30	45	75	16	26	35	130	–	–	
115	37	55	90	17	28	43	160	–	–	
150	48	75	96	20	33	48	190	–	–	

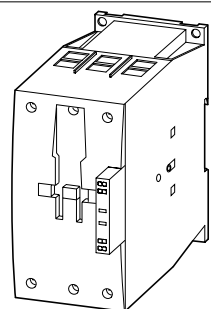
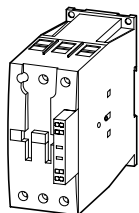
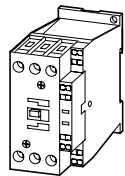
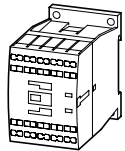

Can be combined with auxiliary contact	AC operation	DC operation	Std. pack	Notes
	Type Article no.	Type Article no.		

DILM32-XHIC... DILA-XHIC(V)...	DILMC7-10(230V50HZ,240V60HZ) 277389	DILMC7-10(24VDC) 277404		1 pc.
DILA-XHIC(V)...	DILMC7-01(230V50HZ,240V60HZ) 277421	DILMC7-01(24VDC) 277436		
DILM32-XHIC... DILA-XHIC(V)...	DILMC9-10(230V50HZ,240V60HZ) 277453	DILMC9-10(24VDC) 277468		
DILA-XHIC(V)...	DILMC9-01(230V50HZ,240V60HZ) 277485	DILMC9-01(24VDC) 277500		
DILM32-XHIC... DILA-XHIC(V)...	DILMC12-10(230V50HZ,240V60HZ) 277517	DILMC12-10(24VDC) 277532		
DILA-XHIC(V)...	DILMC12-01(230V50HZ,240V60HZ) 277549	DILMC12-01(24VDC) 277564		
DILM32-XHIC... DILA-XHIC(V)...	DILMC15-10(230V50HZ,240V60HZ) 293911	DILMC15-10(24VDC) 293926		
DILA-XHIC(V)...	DILMC15-01(230V50HZ,240V60HZ) 293946	DILMC15-01(24VDC) 293961		

DILM32-XHIC... DILA-XHIC(V)...	DILMC17-10(230V50HZ,240V60HZ) 277581	DILMC17-10(RDC24) 277595		1 pc.
DILA-XHIC(V)...	DILMC17-01(230V50HZ,240V60HZ) 277611	DILMC17-01(RDC24) 277625		
DILM32-XHIC... DILA-XHIC(V)...	DILMC25-10(230V50HZ,240V60HZ) 277641	DILMC25-10(RDC24) 277655		
DILA-XHIC(V)...	DILMC25-01(230V50HZ,240V60HZ) 277671	DILMC25-01(RDC24) 277685		
DILM32-XHIC... DILA-XHIC(V)...	DILMC32-10(230V50HZ,240V60HZ) 277701	DILMC32-10(RDC24) 277715		
DILA-XHIC(V)...	DILMC32-01(230V50HZ,240V60HZ) 277731	DILMC32-01(RDC24) 277745		
DILM150-XHIC(V)... DILM1000-XHIC...	DILMC40(230V50HZ,240V60HZ) 277965	DILMC40(RDC24) 277979		
	DILMC50(230V50HZ,240V60HZ) 277995	DILMC50(RDC24) 278009		
	DILMC65(230V50HZ,240V60HZ) 278025	DILMC65(RDC24) 278039		
	DILMC80(230V50HZ,240V60HZ) 239618	DILMC80(RDC24) 239652		
	DILMC95(230V50HZ,240V60HZ) 239685	DILMC95(RDC24) 239715		
	DILMC115(RAC240) 239736	DILMC115(RDC24) 239741		
	DILMC150(RAC240) 239751	DILMC150(RDC24) 239765		

Contacts according to EN 50012.
For DILMC7 – DILMC15 the following applies:
Auxiliary current, coil, and main current terminals with spring-cage connection technology.
For DILMC17 – DILMC150 the following applies:
• Auxiliary current, coil connections with spring-loaded terminal technology.
• Main current connections with screw terminals.
For DC operated contactors DILMC7 – DILMC15 the following applies:
Integrated varistor suppressor circuit.
For DC operated contactors DILMC17 – DILMC150 the following applies:
Integrated suppressor circuit in actuating electronics.
For AC operated contactors DILMC115 – DILMC150 the following applies:
Integrated suppressor circuit in actuating electronics.
For DILMC7-01 – DILMC32-01 the following applies:
With mirror contact.

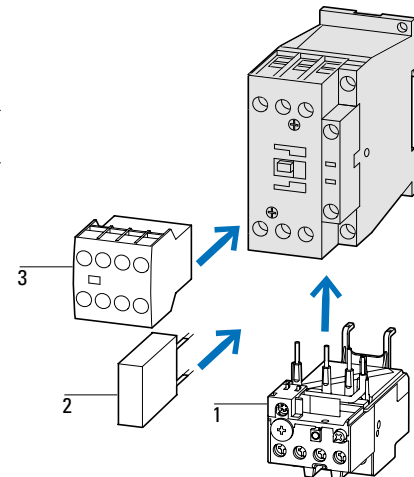

Accessories	Page
1 Overload relays	→ 2/8
2 Suppressor	→ 1/64
3 Auxiliary contact module	→ 1/44
Accessories	→ 1/66
Further actuating voltages	→ 1/83



Also suitable for motors with efficiency class IE3.
IE3-ready devices are identified by the logo on their packaging.

Information relevant for export to North America



Product standards	IEC/EN 60947-4-1; UL 60947-4-1; CSA-C22.2 No. 14-05; CE marking
UL File No.	E29096
UL CCN	NLDX
CSA File No.	012528
CSA Class No.	2411-03, 3211-04
NA Certification	UL Listed, CSA certified

Notes

in conjunction with SmartWire-DT module → Page 1/72

DILM complete devices up to 150 A

1

Rated operational current	max. Motor rating three-phase motors 50 - 60 Hz						Conventional thermal current 3-pole AC-1 at 40 °C open $I_{th} = I_e$	Contact configuration	
	AC-3			AC-4				Contact configuration: ☉ = safety function, by positive opening to IEC/EN 60947-5-1	
380 V 400 V	220 V 230 V	380 V 400 V	660 V 690 V	220 V 230 V	380 V 400 V	660 V 690 V			
I_e	P	P	P	P	P	P		N/O = normally open	N/C = normally closed contact
A	kW			kW			A		

DILM complete devices

Screw terminals

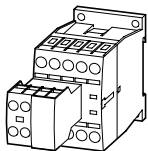

Rated operational current	max. Motor rating three-phase motors 50 - 60 Hz						Conventional thermal current 3-pole AC-1 at 40 °C open $I_{th} = I_e$	Contact configuration		
	AC-3			AC-4				Contact configuration: ☉ = safety function, by positive opening to IEC/EN 60947-5-1		
380 V 400 V	220 V 230 V	380 V 400 V	660 V 690 V	220 V 230 V	380 V 400 V	660 V 690 V				
I_e	P	P	P	P	P	P		N/O = normally open	N/C = normally closed contact	
A	kW			kW			A			
IE3 ✓	7	2.2	3	3.5	1	2.2	2.9	22	2 N/O	1 N/C
	7	2.2	3	3.5	1	2.2	2.9	22	2 N/O	2 N/C
	7	2.2	3	3.5	1	2.2	2.9	22	3 N/O	2 N/C
	9	2.5	4	4.5	1.5	2.5	3.6	22	2 N/O	1 N/C
	9	2.5	4	4.5	1.5	2.5	3.6	22	2 N/O	2 N/C
	9	2.5	4	4.5	1.5	2.5	3.6	22	3 N/O	2 N/C
	12	3.5	5.5	6.5	2	3	4.4	22	2 N/O	1 N/C
	12	3.5	5.5	6.5	2	3	4.4	22	2 N/O	2 N/C
	12	3.5	5.5	6.5	2	3	4.4	22	3 N/O	2 N/C
-	15.5	4	7.5	7	2	3	4.4	22	2 N/O	2 N/C

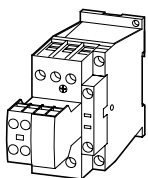

Rated operational current	max. Motor rating three-phase motors 50 - 60 Hz						Conventional thermal current 3-pole AC-1 at 40 °C open $I_{th} = I_e$	Contact configuration		
	AC-3			AC-4				Contact configuration: ☉ = safety function, by positive opening to IEC/EN 60947-5-1		
380 V 400 V	220 V 230 V	380 V 400 V	660 V 690 V	220 V 230 V	380 V 400 V	660 V 690 V				
I_e	P	P	P	P	P	P		N/O = normally open	N/C = normally closed contact	
A	kW			kW			A			
IE3 ✓	18	5	7.5	11	2.5	4.5	6.5	40	2 N/O	1 N/C
	18	5	7.5	11	2.5	4.5	6.5	40	2 N/O	2 N/C
	18	5	7.5	11	2.5	4.5	6.5	40	3 N/O	2 N/C
	25	7.5	11	14	3.5	6	8.5	45	2 N/O	1 N/C
	25	7.5	11	14	3.5	6	8.5	45	2 N/O	2 N/C
	25	7.5	11	14	3.5	6	8.5	45	3 N/O	2 N/C
	32	10	15	17	4	7	10	45	2 N/O	1 N/C
	32	10	15	17	4	7	10	45	2 N/O	2 N/C
	32	10	15	17	4	7	10	45	3 N/O	2 N/C

Notes

Information relevant for export to North America



Product standards
UL File No.
UL CCN
CSA File No.
CSA Class No.
NA Certification

IEC/EN 60947-4-1; UL 60947-4-1; CSA-C22.2 No. 60947-4-1-14; CE marking
E29096
NLDX
012528
2411-03, 3211-04
UL Listed, CSA certified



Also suitable for motors with efficiency class IE3.
IE3-ready devices are identified by the logo on their packaging.

Circuit symbol	AC operation Type Article no.	DC operation Type Article no.	Std. pack	Notes
	DILM7-21(230V50HZ,240V60HZ) 276620	DILM7-21(24VDC) 276635	1 pc. 	 Accessories 1 Overload relays → 2/8 2 Suppressor → 1/64 Accessories → 1/66 For DC operated contactors DILM7 – DILM15 the following applies: Integrated varistor suppressor circuit. For DC operated contactors DILM17 – DILM170 the following applies: Integrated suppressor circuit in actuating electronics. For DILM7 – DILM150: with mirror contact. Contacts according to EN 50012.
	DILM7-22(230V50HZ,240V60HZ) 106360	DILM7-22(24VDC) 106367		
	DILM7-32(230V50HZ,240V60HZ) 276655	DILM7-32(24VDC) 276670		
	DILM9-21(230V50HZ,240V60HZ) 276760	DILM9-21(24VDC) 276775		
	DILM9-22(230V50HZ,240V60HZ) 106361	DILM9-22(24VDC) 106368		
	DILM9-32(230V50HZ,240V60HZ) 276795	DILM9-32(24VDC) 276810		
	DILM12-21(230V50HZ,240V60HZ) 276900	DILM12-21(24VDC) 276915		
	DILM12-22(230V50HZ,240V60HZ) 106362	DILM12-22(24VDC) 106369		
	DILM12-32(230V50HZ,240V60HZ) 276935	DILM12-32(24VDC) 276950		
	DILM15-22(230V50HZ,240V60HZ) 106363	DILM15-22(24VDC) 106370		
	DILM17-21(230V50HZ,240V60HZ) 277068	DILM17-21(RDC24) 277082		
	DILM17-22(230V50HZ,240V60HZ) 106364	DILM17-22(RDC24) 106371		
	DILM17-32(230V50HZ,240V60HZ) 277100	DILM17-32(RDC24) 277114		
	DILM25-21(230V50HZ,240V60HZ) 277196	DILM25-21(RDC24) 277210		
	DILM25-22(230V50HZ,240V60HZ) 106365	DILM25-22(RDC24) 106372		
	DILM25-32(230V50HZ,240V60HZ) 277228	DILM25-32(RDC24) 277242		
	DILM32-21(230V50HZ,240V60HZ) 277324	DILM32-21(RDC24) 277338		
	DILM32-22(230V50HZ,240V60HZ) 106366	DILM32-22(RDC24) 106373		
	DILM32-32(230V50HZ,240V60HZ) 277356	DILM32-32(RDC24) 277370		

DILM complete devices up to 150 A

1

Rated operational current	max. Motor rating three-phase motors 50 - 60 Hz						Conventional thermal current 3-pole AC-1 at 40 °C open $I_{th} = I_e$	Contact configuration	
	AC-3			AC-4				Contact configuration: ⊕ = safety function, by positive opening to IEC/EN 60947-5-1	
380 V	220 V	380 V	660 V	220 V	380 V	660 V	N/O = normally open	N/C = normally closed contact	
400 V	230V	400 V	690 V	230 V	400 V	690 V			
I_e	P	P	P	P	P	P			
A	kW	kW	kW	kW	kW	kW	A		

DILM complete devices

Screw terminals

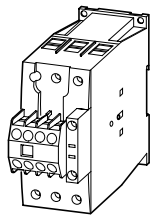

	40	50	65	80	95	115	150		
IE3 ✓	12.5	15.5	20	25	30	37	48	18.5	22
	23	30	35	63	75	90	96	5	6
	9	10	12	11.5	16	17	20	26	26
	12	14	17	20	26	28	33	26	35
	60	80	98	110	130	160	190	2 N/O	2 N/C

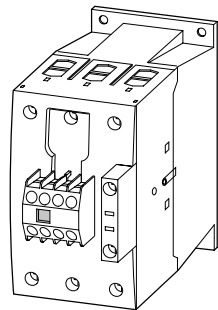

Notes

Information relevant for export to North America



Product standards	IEC/EN 60947-4-1; UL 60947-4-1; CSA-C22.2 No. 60947-4-1-14; CE marking
UL File No.	E29096
UL CCN	NLDX
CSA File No.	012528
CSA Class No.	2411-03, 3211-04
NA Certification	UL Listed, CSA certified



Also suitable for motors with efficiency class IE3.
IE3-ready devices are identified by the logo on their packaging.

Circuit symbol	AC operation Type Article no.	DC operation Type Article no.	Std. pack	Notes
----------------	-------------------------------------	-------------------------------------	-----------	-------

	DILM40-22(230V50HZ,240V60HZ) 277798	DILM40-22(RDC24) 277812	1 pc.
	DILM50-22(230V50HZ,240V60HZ) 277862	DILM50-22(RDC24) 277876	
	DILM65-22(230V50HZ,240V60HZ) 277926	DILM65-22(RDC24) 277940	
	DILM80-22(230V50HZ,240V60HZ) 239449	DILM80-22(RDC24) 239463	
	DILM95-22(230V50HZ,240V60HZ) 239527	DILM95-22(RDC24) 239541	
	DILM115-22(RAC240) 239578	DILM115-22(RDC24) 239581	
	DILM150-22(RAC240) 239598	DILM150-22(RDC24) 239601	

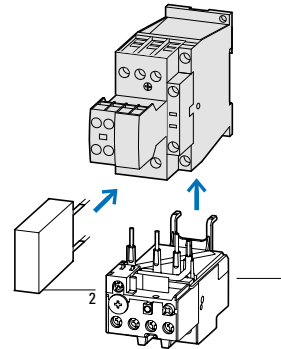

Accessories	Page
1 Overload relays	→ 2/8
2 Suppressor	→ 1/64
Accessories	→ 1/66

For DC operated contactors DILM17 – DILM150 the following applies:
Integrated suppressor circuit in actuating electronics
For AC operated contactors DILM115 – DILM150 the following applies:
Integrated suppressor circuit in actuating electronics.
For DILM7 – DILM150: with mirror contact.
Contacts according to EN 50012.

DILMF contactors up to 150 A with electronic actuation

1

Poles	Rated operational current	max. Motor rating three-phase motors 50 - 60 Hz						Conventional thermal current 3-pole AC-1 at 40 °C open $I_{th} = I_e$ A	Contact configuration	
	AC-3 380 V 400 V	AC-3			AC-4				Contact configuration: ⊕ = safety function, by positive opening to IEC/EN 60947-5-1 N/O = normally open N/C = normally closed contact	
I_e A		P kW	P kW	P kW	P kW	P kW	P kW			

Basic devices

Screw terminals

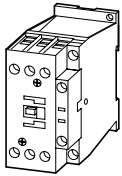

IE3 ✓	3-pole	Poles	max. Motor rating three-phase motors 50 - 60 Hz						Conventional thermal current 3-pole AC-1 at 40 °C open $I_{th} = I_e$ A	Contact configuration	
			AC-3 380 V 400 V	AC-3			AC-4			Contact configuration: ⊕ = safety function, by positive opening to IEC/EN 60947-5-1 N/O = normally open N/C = normally closed contact	
I_e A			P kW	P kW	P kW	P kW	P kW	P kW			
IE3 ✓	3-pole	7	2.2	3	3.5	1	2.2	2.9	22	1 N/O	–
		7	2.2	3	3.5	1	2.2	2.9	22	–	1 N/C
		9	2.5	4	4.5	1.5	2.5	3.6	22	1 N/O	–
		9	2.5	4	4.5	1.5	2.5	3.6	22	–	1 N/C
		12	3.5	5.5	6.5	2	3	4.4	22	1 N/O	–
		12	3.5	5.5	6.5	2	3	4.4	22	–	1 N/C
		18	5	7.5	11	2.5	4.5	6.5	40	1 N/O	–
		18	5	7.5	11	2.5	4.5	6.5	40	–	1 N/C
		25	7.5	11	14	3.5	6	8.5	45	1 N/O	–
		25	7.5	11	14	3.5	6	8.5	45	–	1 N/C
		32	10	15	17	4	7	10	45	1 N/O	–
		32	10	15	17	4	7	10	45	–	1 N/C

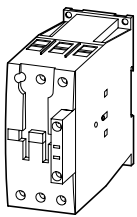

IE3 ✓	3-pole	Poles	max. Motor rating three-phase motors 50 - 60 Hz						Conventional thermal current 3-pole AC-1 at 40 °C open $I_{th} = I_e$ A	Contact configuration	
			AC-3 380 V 400 V	AC-3			AC-4			Contact configuration: ⊕ = safety function, by positive opening to IEC/EN 60947-5-1 N/O = normally open N/C = normally closed contact	
I_e A			P kW	P kW	P kW	P kW	P kW	P kW			
IE3 ✓	3-pole	40	12.5	18.5	23	5	9	12	60	–	–
		50	15.5	22	30	6	10	14	80	–	–
		65	20	30	35	7	12	17	98	–	–

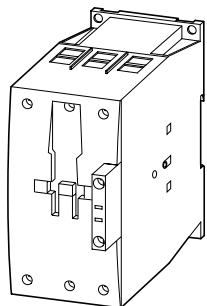

IE3 ✓	3-pole	Poles	max. Motor rating three-phase motors 50 - 60 Hz						Conventional thermal current 3-pole AC-1 at 40 °C open $I_{th} = I_e$ A	Contact configuration	
			AC-3 380 V 400 V	AC-3			AC-4			Contact configuration: ⊕ = safety function, by positive opening to IEC/EN 60947-5-1 N/O = normally open N/C = normally closed contact	
I_e A			P kW	P kW	P kW	P kW	P kW	P kW			
IE3 ✓	3-pole	80	25	37	63	11.5	20	26	110	–	–
		95	30	45	75	16	26	35	130	–	–
		115	37	55	90	17	28	43	160	–	–
		150	48	75	96	20	33	48	190	–	–

Notes

Information relevant for export to North America



Product standards	IEC/EN 60947-4-1; UL 60947-4-1; CSA-C22.2 No. 60947-4-1-14; CE marking
UL File No.	E29096
UL CCN	NLDX
CSA File No.	012528
CSA Class No.	2411-03, 3211-04
NA Certification	UL Listed, CSA certified



Also suitable for motors with efficiency class IE3.
IE3-ready devices are identified by the logo on their packaging.

DILMF contactors up to 150 A with electronic actuation

AC operation
 Circuit symbol **Type** Std. pack **Notes**
 Article no.

	DILMF8-10(RAC240) 104413
	DILMF8-01(RAC240) 104417
	DILMF11-10(RAC240) 104421
	DILMF11-01(RAC240) 104425
	DILMF14-10(RAC240) 104429
	DILMF14-01(RAC240) 104433
	DILMF17-10(RAC240) 104437
	DILMF17-01(RAC240) 104441
	DILMF25-10(RAC240) 104445
	DILMF25-01(RAC240) 104449
	DILMF32-10(RAC240) 104453
	DILMF32-01(RAC240) 104457
	DILMF40(RAC240) 104461
	DILMF50(RAC240) 104465
	DILMF65(RAC240) 104469
	DILMF80(RAC240) 104473
	DILMF95(RAC240) 104477
	DILMF115(RAC240) 104481
	DILMF150(RAC240) 104485

1 pc.

Contactors suitable for semi-conductor industry according to SEMI F47.
 Contactors hum-free, suitable for building services automation.
 Operating mechanism adjustable from 50 Hz to 400 Hz.

For all contactors the following applies:
 Integrated suppressor circuit
 For DILMF8-01 – DILMF32-01 the following applies:
 With mirror contact.
 Contacts according to EN 50012.

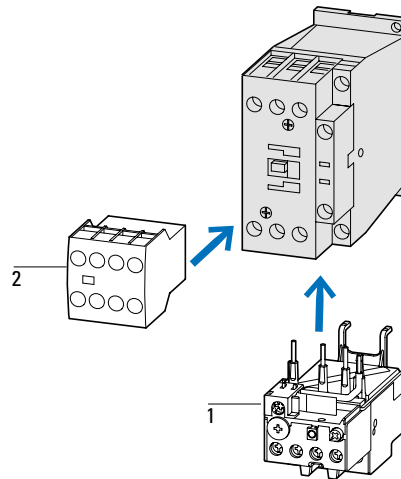

Accessories	Page
1 Overload relays	→ 2/8
2 Auxiliary contact module	→ 1/17
Accessories	→ 1/66
Further actuating voltages	→ 1/89

DILM standard devices greater than 170 A





1

Rated operational current	max. Motor rating three-phase motors 50 - 60 Hz						Conventional thermal current 3-pole AC-1 at 40 °C open	Circuit symbol	For use with
	AC-3			AC-4					
380 V	220 V	380 V	660 V	220 V	380 V	660 V		DILM820-XHI...	
400 V	230 V	400 V	690 V	230 V	400 V	690 V			
I_b	P	P	P	P	P	P	$I_{th} = I_b$		
A	kW	kW	kW	kW	kW	kW	A		

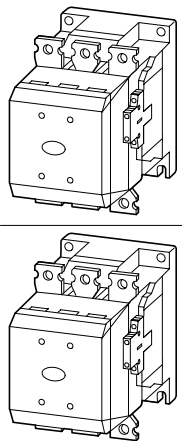
DILM complete devices

Screw connection, 3-pole



250	75	132	170	62	110	137	430		DILM820-XHI...
300	90	160	170	75	132	137	490		DILM820-XHI...
400	125	212	300	92	160	240	612		DILM820-XHI...
500	155	265	300	112	200	240	800		DILM820-XHI...

Notes

For all contactors the following applies:
660 V, 690 V or 1000 V: not directly reversing
Integrated suppressor circuit in actuating electronics.

DILM...-S contactors are actuated traditionally.

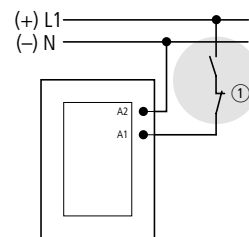

① Stopping in the event of an emergency (emergency switching off)

Accessories

Auxiliary contact modules
Surface mounting enclosure
Further actuating voltages

Page

→ 1/47
→ 1/90

Type
Article no.

Std. pack

Information relevant for export to North America



DILM250-S/22(220-240V50/60HZ) 274190	1 pc. 	Product standards UL File No. UL CCN CSA File No. CSA Class No. NA Certification	IEC/EN 60947-4-1; UL 60947-4-1; CSA-C22.2 No. 60947-4-1-14; CE marking E29096 NLDX 1017510 3211-04 UL Listed, CSA certified
DILM300A-S/22(220-240V50/60HZ) 139559			
DILM400-S/22(220-240V50/60HZ) 274196	1 pc. 	Product standards UL File No. UL CCN CSA File No. CSA Class No. NA Certification	IEC/EN 60947-4-1; UL 60947-4-1; CSA-C22.2 No. 60947-4-1-14; CE marking E29096 NLDX 012528 3211-04 UL Listed, CSA certified
DILM500-S/22(220-240V50/60HZ) 274199			

DILM comfort devices greater than 170 A

1

Rated operational current	max. Motor rating three-phase motors 50 - 60 Hz								Conventional thermal current AC-1 at 60 °C open $I_{th} = I_e$ A
	AC-3				AC-4				
380 V 400 V	220 V 230 V	380 V 400 V	660 V 690 V	1000 V	220 V 230 V	380 V 400 V	660 V 690 V	1000 V	
I_e A	P kW	P kW	P kW	P kW	P kW	P kW	P kW	P kW	

DILM contactors, comfort

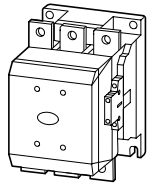

185	55	90	140	108	41	75	102	77	275
-----	----	----	-----	-----	----	----	-----	----	-----

225	70	110	150	108	51	90	110	77	315
-----	----	-----	-----	-----	----	----	-----	----	-----

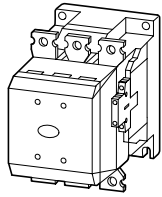

250	75	132	170	108	62	110	137	108	350
-----	----	-----	-----	-----	----	-----	-----	-----	-----

300	90	160	170	132	75	132	137	108	400
-----	----	-----	-----	-----	----	-----	-----	-----	-----

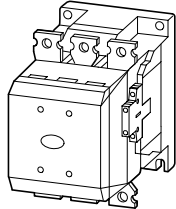

400	125	212	300	132	92	160	240	132	500
-----	-----	-----	-----	-----	----	-----	-----	-----	-----

500	155	265	300	132	112	200	240	132	650
-----	-----	-----	-----	-----	-----	-----	-----	-----	-----

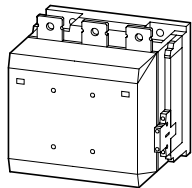

580	185	315	560	600	143	250	440	509	800
-----	-----	-----	-----	-----	-----	-----	-----	-----	-----

650	205	355	630	600	161	280	494	509	850
-----	-----	-----	-----	-----	-----	-----	-----	-----	-----

750	240	400	720	800	181	315	556	678	900
-----	-----	-----	-----	-----	-----	-----	-----	-----	-----

820	260	450	750	800	209	355	633	678	1000
-----	-----	-----	-----	-----	-----	-----	-----	-----	------

1000	315	560	1000	1100	260	450	780	1000	1000
------	-----	-----	------	------	-----	-----	-----	------	------

1000	315	560	1000	1100	260	450	780	1000	1000
------	-----	-----	------	------	-----	-----	-----	------	------

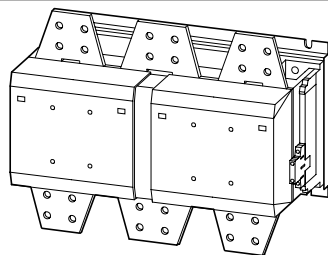

1600	500	900	1600	1770	430	750	1300	1650	1800
------	-----	-----	------	------	-----	-----	------	------	------

Notes

For all contactors the following applies:
660 V, 690 V or 1000 V: not directly reversing
Integrated suppressor circuit in actuating electronics.

During high-voltage tests, the suppressor circuit on the load side for DILM580 to DILH2600 contactors must be disconnected (see instruction leaflet).
A suppressor circuit on the load side is included in the basic features of devices DILM580 to DILH2600.

Control voltages
RAC240 Δ 190 V - 240 V AC
RAW250 Δ 230 V - 250 V AC, 350 V DC
RA250 Δ 110 V - 250 V AC, 350 V DC
RAC500 Δ 250 V - 500 V AC, 700 V DC

Accessories

- Auxiliary contact modules
- Suppressor circuits on load side
- Surface mounting enclosure
- Further actuating voltages

Page

- 1/48
- 1/74
- 
- 1/85

Circuit symbol **Type**
Article no. Std. pack **Notes**



DILM185A/22(RAC240)¹⁾
139537
DILM225A/22(RAC240)¹⁾
139547



Classical

A1/A2 are attached to power supply as normal

DILM185A
DILM225A

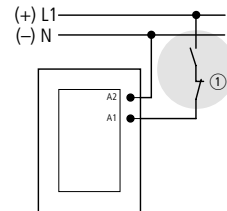

DILM250 – DILM1600
DILH1200 – DILH2600

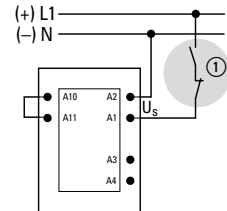

DILM250/22(RA250)²⁾
208201
DILM300A/22(RA250)²⁾
139556

Direct from the PLC

A 24 V output from the PLC can be directly connected to the connections A3/A4.

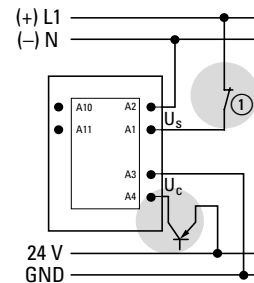
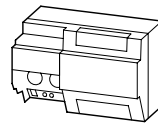

DILM400/22(RA250)³⁾
208209
DILM500/22(RA250)³⁾
208213

DILM580/22(RA250)³⁾
208216

DILM650/22(RA250)³⁾
208219

DILM750/22(RA250)³⁾
208222

DILM820/22(RA250)³⁾
208225

DILM1000/22(RA250)³⁾
267214

DILM1000/22(RAC500)³⁾
271990

DILM1600/22(RAW250)³⁾
106727

From a low-power actuating device

Low-power actuating devices such as PCB relays, actuating devices or position switches can be directly connected to A10/A11.

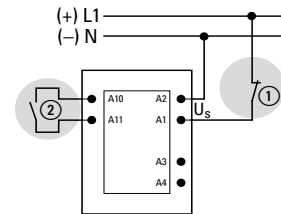

- ① Stopping in the event of an emergency (emergency switching off)
- ② max. Capacity 6 nF

Information relevant for export to North America



Product standards	IEC/EN 60947-4-1; UL 60947-4-1; CSA-C22.2 No. 60947-4-1-14; CE marking
UL File No.	E29096
UL CCN	NLDX
CSA File No.	¹⁾ 2389068 ²⁾ 1017510 ³⁾ 012528
CSA Class No.	3211-04
NA Certification	UL Listed, CSA certified

DILH comfort devices greater than 170 A

1

Conventional thermal current
AC-1
at 60 °C
open
 $I_{th} = I_e$
A



Circuit symbol

Type
Article no.

Std. pack

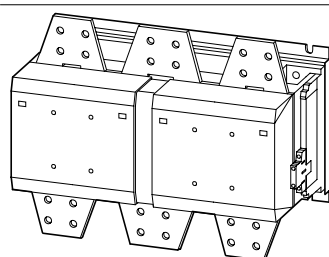
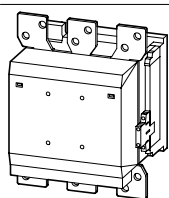
AC-1 DILH contactors, comfort



1200	DILH1200/22(RAW250) 151242	1 pc.
1400	DILH1400/22(RA110) 179529	 
1400	DILH1400/22(RA250) 168618	
1400	DILH1400/22(RAC500) 144054	
1400	DILH1400/22(RAW250) 272441	
2000	DILH2000/22(RAW250) 272442	
2200	DILH2200/22(RAW250) 111793	
2600	DILH2600/22(RAW250) 125945	

Notes

For all contactors the following applies:
660 V, 690 V or 1000 V: not directly reversing
Integrated suppressor circuit in actuating electronics.

During high-voltage tests, the suppressor circuit on the load side for DILM580 to DILH2600 contactors must be disconnected (see instruction leaflet).
A suppressor circuit on the load side is included in the basic features of devices DILM580 to DILH2600.

Control voltages
RA110 \triangleq 48 V - 110 V AC, 110 V DC
RAW250 \triangleq 230 V - 250 V AC, 350 V DC
RA250 \triangleq 110 V - 250 V AC, 350 V DC
RAC500 \triangleq 250 V - 500 V AC, 700 V DC

Accessories

Auxiliary contact modules
Suppressor circuits on load side
Surface mounting enclosure

Page

→ 1/48
→ 1/74



Notes

Classical

A1/A2 are attached to power supply as normal

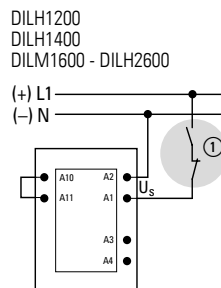

Direct from the PLC

A 24 V output from the PLC can be directly connected to the connections A3/A4.

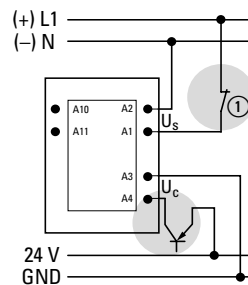
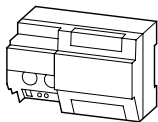

From a low-power actuating device

Low-power actuating devices such as PCB relays, actuating devices or position switches can be directly connected to A10/A11.

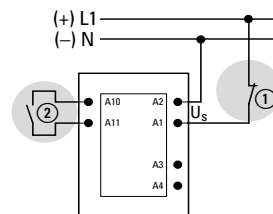

- ① Stopping in the event of an emergency (emergency switching off)
- ② max. Capacity 6 nF

Information relevant for export to North America



Product standards	IEC/EN 60947-4-1; UL 60947-4-1; CSA-C22.2 No. 60947-4-1-14; CE marking
UL File No.	E29096
UL CCN	NLDX
CSA File No.	012528
CSA Class No.	3211-04
NA Certification	UL Listed, CSA certified

4-pole DILMP contactor up to 200 A

1

Rated operational current $I_o =$
Conventional thermal current
 $I_{th} = I_o$ open, 3-pole, open

Circuit symbol





For use with

AC-1

40 °C	50 °C	55 °C	60 °C
A	A	A	A

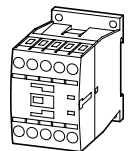
Contactors up to 200 A

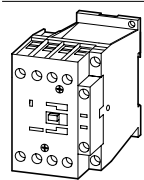
Screw terminals, 4-pole

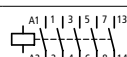
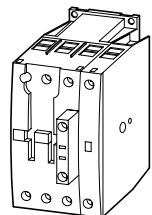
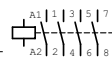
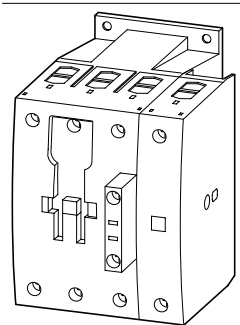
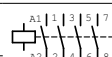
	22	21	20.5	20		DILM32-XHI(C)... DILA-XHI(V)(C)...		
		32	30	29			28	
32		30	29	28				
45		41	40	39				
45		41	40	39				
	63	60	58	54		DILM150-XHI(A)(V)... DILM1000-XHI11-SA ¹⁾ DILM1000-XHI(V)11-SI ¹⁾		
	80	76	73	69				
	125	116	110	108		DILM150-XHI(A)(V)... DILM1000-XHI(V)... ¹⁾		
	160	150	143	138				
	200	188	180	172				

Notes

¹⁾ DILM1000-XHI... can only be fitted to the left of DILMP.

Contacts according to EN 50012.

For DC operated conductors DILMP20 the following applies:

Integrated varistor suppressor circuit.

For DC operated contactors DILMP32 – DILMP200 the following applies:

Integrated suppressor circuit in actuating electronics.

For AC operated contactors DILMP125 – DILMP200 the following applies:

Integrated suppressor circuit in actuating electronics.

For DILMP32-01 and DILMP45-01 the following applies:

With mirror contact.





Information relevant for export to North America



Product standards	IEC/EN 60947-4-1; UL 60947-4-1; CSA-C22.2 No. 60947-4-1-14; CE marking
UL File No.	E29096
UL CCN	NLDX
CSA File No.	012528
CSA Class No.	2411-03, 3211-04
NA Certification	UL Listed, CSA certified

AC operation	DC operation		
Type	Type	Std. pack	Notes
Article no.	Article no.		

DILMP20(230V50HZ,240V60HZ) 276970	DILMP20(24VDC) 276985	 1 pc.  
---	---------------------------------	--

DILMP32-01(230V50HZ,240V60HZ) 118911	DILMP32-01(RDC24) 118913	
DILMP45-01(230V50HZ,240V60HZ) 118914	DILMP45-01(RDC24) 118916	
DILMP32-10(230V50HZ,240V60HZ) 109797	DILMP32-10(RDC24) 109811	
DILMP45-10(230V50HZ,240V60HZ) 109826	DILMP45-10(RDC24) 109840	
DILMP63(230V50HZ,240V60HZ) 109855	DILMP63(RDC24) 109869	
DILMP80(230V50HZ,240V60HZ) 109884	DILMP80(RDC24) 109898	

DILMP125(RAC240) 109905	DILMP125(RDC24) 109910
DILMP160(RAC240) 109915	DILMP160(RDC24) 109920
DILMP200(RAC240) 109925	DILMP200(RDC24) 109930

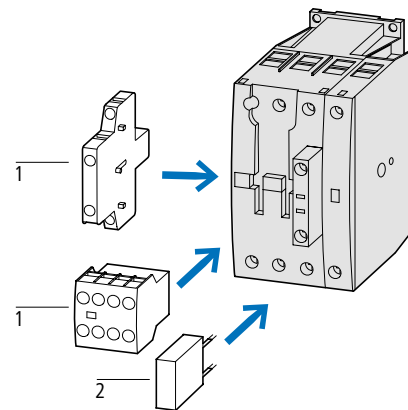



































Accessories	Page
1 Auxiliary contact module	→ 1/16
2 Suppressor	→ 1/64
Accessories	→ 1/66
Further actuating voltages	→ 1/42

 in conjunction with SmartWire-DT module → Page 1/72

DILM...XHI..., DILA...XHI... auxiliary contact modules

1

Connection technology	Poles	Conventional thermal current at 60 °C open	Contact configuration	Contact sequence	Contact sequence diagram	For use with	Type Article no.	Std. pack
Auxiliary contact modules								
Top mounting auxiliary contact – front mounting								
	2-pole	16	1 N/O	1 N/C		DILM(C)7-10... DILM(C)9-10... DILM(C)12-10... DILM(C)15-10... DILM(C)17-10... DILM(C)25-10...	DILM32-XHI11 277376	5 pcs. 
			–	2 N/C		DILM(C)32-10... DILM38-10... DILMP20... DILMP32-10... DILMP45-10... DILL...	DILM32-XHI02 277375	
	4-pole	–	2 N/O	2 N/C		DILM(C)32-10... DILM38-10... DILMP20... DILMP32-10... DILMP45-10... DILL...	DILM32-XHI22 277377	
			3 N/O	1 N/C		DILMF8-10... DILMF11-10... DILMF14-10... DILMF17-10... DILMF25-10... DILMF32-10...	DILM32-XHI31 106112	
	2-pole	16	1 N/O	1 N/C		DILMF8-10... DILMF11-10... DILMF14-10... DILMF17-10... DILMF25-10... DILMF32-10...	DILM32-XHIC11 277751	
			–	2 N/C		DILM32-XHIC02 277750		
	4-pole	–	2 N/O	2 N/C			DILM32-XHIC22 277752	
			3 N/O	1 N/C		DILM32-XHIC31 106490		
	2-pole	16	2 N/O	–		DILA(C)... DILM(C)7... DILM(C)9... DILM(C)12... DILM(C)15... DILM(C)17... DILM(C)25... DILM(C)32... DILM38... DILMP20... DILMP32... DILMP45... DILL...	DILA-XHI20 276422	
			1 N/O	1 N/C		DILMF8... DILMF11... DILMF14... DILMF17... DILMF25... DILMF32...	DILA-XHI11 276421	
	–	–	1 N/O	1 N/C		DILM(C)32... DILM38... DILMP20... DILMP32... DILMP45... DILL...	DILA-XHIR11²⁾³⁾ 110140	
			Compatible with electronics	2 N/C		DILA-XHI02 276420		
	–	–	1 N/O _E	1 N/C _L		DILM(C)32... DILM38... DILMP20... DILMP32... DILMP45... DILL...	DILA-XHIV11 276423	
			1 N/O _E	1 N/C _L		DILA-XHIV22¹⁾²⁾³⁾ 139580		
	4-pole	16	4 N/O	–		DILM(C)32... DILM38... DILMP20... DILMP32... DILMP45... DILL...	DILA-XHI40²⁾ 276428	
			3 N/O	1 N/C		DILA-XHI31²⁾ 276427		
	–	–	2 N/O	2 N/C			DILA-XHI22²⁾ 276426	
			2 N/O	2 N/C		DILA-XHIR22¹⁾²⁾³⁾ 139580		
	–	–	1 N/O	3 N/C			DILA-XHI13²⁾ 276425	
			–	4 N/C		DILA-XHI04²⁾ 276424		
	–	–	1 N/O	1 N/C			DILA-XHIV22²⁾ 276429	
			1 N/O _E	1 N/C _L				

Notes
 Auxiliary NC usable as mirror contact according to IEC/EN 60947-4-1 appendix F (no NC late-breaks)
 Interlocked opposing contacts according to IEC/EN 60947-5-1 appendix L, inside the auxiliary contact modules, also for the integrated auxiliary contacts of the DILM 7 - DILM32
 No NC late-breaks, no NO early-makes

¹⁾ 1 N/C + 1 N/O via microswitches for electronic applications (not interlocked opposing, not mirror contact)
²⁾ Cannot be combined with DILA(C)-22 (...VDC).
³⁾ Compatible with electronics

Information relevant for export to North America



Product standards IEC/EN 60947-4-1; UL 508; CSA-C22.2 No. 14-05; CE marking
 UL File No. E29184
 UL CCN NKCR
 CSA File No. 012528
 CSA Class No. 3211-03
 NA Certification UL Listed, CSA certified

DILM...XHI..., DILA...XHI... auxiliary contact modules

Connection technology	Poles	Conventional thermal current at 60 °C open	Contact configuration	Contact sequence	For use with	Type Article no.	Std. pack
		$I_{th} = I_e$ A	N/O = normally open NO _E : NO early-make N/C = normally closed contact NC _L =NC late-break				

Auxiliary contact modules

Top mounting auxiliary contact – front mounting

Front-mounting auxiliary contacts



Spring-loaded terminals	Poles	Conventional thermal current	Contact configuration	Contact sequence	For use with	Type Article no.	Std. pack	
2-pole	16		2 N/O	–		DILA(C)... DILM(C)7... DILM(C)9... DILM(C)12... DILM(C)15... DILM(C)17... DILM(C)25... DILM(C)32... DILM38... DILMP20... DILMP32... DILMP45... DILL... DILMF8... DILMF11... DILMF14... DILMF17... DILMF25... DILMF32...	DILA-XHIC20 276528	5 pcs.
			1 N/O	1 N/C		DILA-XHIC11 276527		
			–	2 N/C		DILA-XHIC02 276526		
			1 N/O _E	1 N/C _L		DILA-XHICV11 276529		



4-pole	16		4 N/O	–		DILA(C)... DILM(C)7... DILM(C)9... DILM(C)12... DILM(C)15... DILM(C)17... DILM(C)25... DILM(C)32... DILM38... DILMP20... DILMP32... DILMP45... DILL... DILMF8... DILMF11... DILMF14... DILMF17... DILMF25... DILMF32...	DILA-XHIC40¹⁾ 276534
			3 N/O	1 N/C		DILA-XHIC31¹⁾ 276533	
			2 N/O	2 N/C		DILA-XHIC22¹⁾ 276532	
			1 N/O	3 N/C		DILA-XHIC13¹⁾ 276531	
			–	4 N/C		DILA-XHIC04¹⁾ 276530	
			1 N/O	1 N/C	1 N/O _E	1 N/C _L	

Notes
 Auxiliary NC usable as mirror contact according to IEC/EN 60947-4-1 appendix F (no NC late-breaks)
 Interlocked opposing contacts according to IEC/EN 60947-5-1 appendix L, inside the auxiliary contact modules, also for the integrated auxiliary contacts of the DILM 7 - DILM32
 No NC late-breaks, no NO early-makes
¹⁾ Cannot be combined with DILA(C)-22(...VDC).

Information relevant for export to North America

 Product standards IEC/EN 60947-4-1; UL 508; CSA-C22.2 No. 14-05; CE marking
 UL File No. E29184
 UL CCN NKCR
 CSA File No. 012528
 CSA Class No. 3211-03
 NA Certification UL Listed, CSA certified



DILM...XHI..., DILA...XHI... auxiliary contact modules

1

Terminal type	Poles	Conventional thermal current at 60 °C open	Contact configuration	Contact sequence	For use with	Type Article no.	Std. pack	Notes
			N/O = normally open N/O _E = N/O early make N/C = normally closed contact N/C _{N/O} = NC late-break					
		$I_{th} = I_e$ A						

Auxiliary contact modules

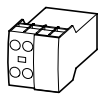
Top mounting auxiliary contact – high type

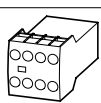
Screw terminals	Poles	16	Contact configuration	Contact sequence	For use with	Type Article no.	Std. pack	Notes
	2-pole	16	2 N/O	–	DILM7... DILM9... DILM12... DILM15... DILL... MSC-D...M7(9, 12, 15)... MSC-R...M7(9, 12)	DILA-XHIT20 101042	5 pcs.  	Interlocked opposing contacts according to IEC/EN 60947-5-1 appendix L, inside the auxiliary contact modules, also for the integrated auxiliary contacts of the DILM7 - DILM32.
			1 N/O	1 N/C		DILA-XHIT11 101043		
			–	2 N/C		DILA-XHIT02 101041		
	4-pole		2 N/O	2 N/C		DILA-XHIT22 101044		Auxiliary contacts used as mirror contacts according to IEC/EN 60947-4-1 Appendix F



Notes

Suitable for the combination with electrical wire jumpers in tool-less plug connection:
 DILM12-XRL
 DILM12-XSL
 DILM12-XS1
 PKZM0-XDM12
 PKZM0-XRM12
 PKZM0-XSM12

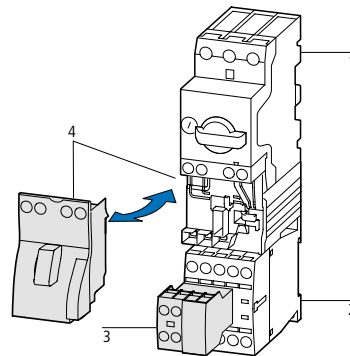
- 1 PKZM0
- 2 DILM7 – DILM15
- 3 DILA-XHIT
- 4 PKZM0-XDM12



Information relevant for export to North America

















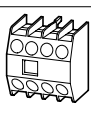



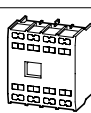

Information relevant for export to North America	
 	
Product standards	IEC/EN 60947-4-1; UL 508; CSA-C22.2 No. 14-05; CE marking
UL File No.	E29184
UL CCN	NKCR
CSA File No.	012528
CSA Class No.	3211-03
NA Certification	UL listed, CSA certified

DILM...XHI..., DILA...XHI... auxiliary contact modules

Terminal type	Poles	Conventional thermal current at 60 °C open	Contact configuration	Contact sequence	For use with	Type Article no.	Std. pack	Notes
		$I_{th} = I_e$	N/O = normally open N/O _E = N/O early make N/C = normally closed contact N/C _{NO} = NC late-break					
		A						

Auxiliary contact modules

Top mounting auxiliary contact – high type

	Screw terminals	2-pole 16	2 N/O	–		DILM40... DILM50... DILM65...	DILM150-XHI20 277945	5 pcs.  	Interlocked opposing contacts according to IEC/EN 60947-5-1 appendix L, inside the auxiliary contact modules (no NC late-breaks, no NO early-makes)
			1 N/O	1 N/C		DILM72... DILM80... DILM95...	DILM150-XHI11 277946		
			1 N/O	1 N/C		DILM115... DILM150... DILM170... DILMP63...	DILM150-XHIA11 283463		
	Screw terminals	4-pole 16	–	2 N/C		DILMP80... DILMP125... DILMP160...	DILM150-XHI02 277947		Auxiliary NC usable as mirror contact according to IEC/EN 60947-4-1 Appendix F (No NC late-breaks)
			4 N/O	–		DILMP200... DILMF40... DILMF50...	DILM150-XHI40 277948		
			3 N/O	1 N/C		DILMF65... DILMF80... DILMF95...	DILM150-XHI31 277949		
			2 N/O	2 N/C		DILMF115... DILMF150...	DILM150-XHI22 277950		
			2 N/O	2 N/C			DILM150-XHIA22 283464		
			1 N/O	3 N/C			DILM150-XHI13 277951		
			–	4 N/C			DILM150-XHI04 277952		
	Spring-loaded terminals	4-pole 16	1 N/O 1 N/O _E	1 N/C 1 N/C _L			DILM150-XHIV22 277953		
			4 N/O	–		DILMC40... DILMC50... DILMC65...	DILM150-XHIC40 278044		
			3 N/O	1 N/C		DILMC80... DILMC95... DILMC115... DILMC150...	DILM150-XHIC31 278045		
			2 N/O	2 N/C			DILM150-XHIC22 278046		
			1 N/O	3 N/C			DILM150-XHIC13 278047		
			–	4 N/C			DILM150-XHIC04 278048		
			2 N/O	2 N/C			DILM150-XHIC22 283465		
1 N/O 1 N/O _E	1 N/C 1 N/C _L			DILM150-XHICV22 278049					

Notes Information relevant for export to North America













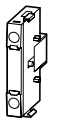



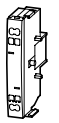

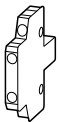

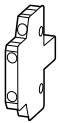
Product standards	IEC/EN 60947-4-1; UL 508; CSA-C22.2 No. 14-05; CE marking
UL File No.	E29184
UL CCN	NKCR
CSA File No.	012528
CSA Class No.	3211-03
NA Certification	UL listed, CSA certified

DILM...XHI..., DILA...XHI... auxiliary contact modules

1

Terminal type	Poles	Conventional thermal current at 60 °C open	Contact configuration	Contact sequence	For use with	Type Article no.	Std. pack
		$I_{th} = I_e$	N/O = normally open N/O _E = N/O early make N/C = normally closed contact N/C _{N/O} = NC late-break				
		A					

Side-mounting auxiliary contacts

	Screw terminals	1-pole	16	1 N/O	–		DILM(C)7... DILM(C)9... DILM(C)12...	DILA-XHI10-S¹⁾ 115948	1 pc. 
				–	1 N/C		DILM(C)15... DILMP20... DILA(C)...	DILA-XHI01-S¹⁾ 115949	
	Spring-loaded terminals	1-pole		1 N/O	–			DILA-XHIC10-S¹⁾ 115950	
				–	1 N/C			DILA-XHIC01-S¹⁾ 115951	
	Screw terminals	2-pole		1 N/O	1 N/C		DILM17... DILM25... DILM32... DILM38... DILMF8... DILMF11... DILMF14... DILMF17... DILMF25... DILMF32...	DILM32-XHI11-S¹⁾ 101371	
	Screw terminals	2-pole	10	1 N/O	1 N/C		DILM250 - DILH2600 DILDC300 - DILDC600	DILM820-XHI11-SI 208281	1 pc. 
				1 N/O	1 N/C			DILM820-XHI11-SA 208282	
				1 N/O _E	1 N/C _L			DILM820-XHI11V-SI 208283	
	Screw terminals	2-pole		1 N/O	1 N/C		DILM(C)40 - DILM225A DILMP63 - DILMP200	DILM1000-XHI11-SI 278425	
				1 N/O _E	1 N/C _L		DILMF40... DILMF50... DILMF65...	DILM1000-XHIV11-SI 278426	
				1 N/O	1 N/C		DILMF80... DILMF95... DILMF115... DILMF150...	DILM1000-XHI11-SA 278427	
	Spring-loaded terminals	2-pole		1 N/O	1 N/C		DILM(C)40 - DILM225A	DILM1000-XHIC11-SI 278428	

Notes

Interlocked opposing contacts according to IEC/EN 60947-5-1 appendix L, inside the auxiliary contact modules, also for the integrated auxiliary contacts of the DILM7 – DILM32 (no NO early-makes and NC late-breaks).
Auxiliary NC usable as mirror contact according to IEC/EN 60947-4-1 Appendix F (no NC late-breaks)

No side-mounting auxiliary contact is possible between 2 contactors with mechanical interlock.

¹⁾ Can only be fitted to the left of the contactor. Cannot be combined with mechanical interlock or top mounting auxiliary contacts

Information relevant for export to North America



Product standards	IEC/EN 60947-4-1; UL 508; CSA-C22.2 No. 14-05; CE marking
UL File No.	E29184
UL CCN	NKCR
CSA File No.	012528
CSA Class No.	3211-03 (DILA...), 3211-04 (DILM...)
NA Certification	UL Listed, CSA certified

Engineering



DILM1000-XHI(V)11-SI

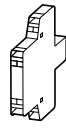

DILM820-XHI11(V)-SI
DILM820-XHIC11-SI

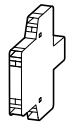

DILM1000-XHI11-SA



DILM820-XHI11-SA



DILM150-XHI20
DILM150-XHI11
DILM150-XHI02



DILM150-XHI40
DILM150-XHI31
DILM150-XHI(V)22
DILM150-XHI13
DILM150-XHI04



DILM150-XHIA11



DILM150-XHIA22

DILM40 – DILM72	2 x	–	–	–	–	–	1 x	–
DILM40 – DILM72	–	–	2 x	–	1 x	–	–	–
DILM40 – DILM72	1 x	–	–	–	–	–	–	1 x
DILM40 – DILM72	–	–	1 x	–	–	1 x	–	–
DILM80 – DILM170	2 x	–	2 x	–	–	–	–	–
DILM80 – DILM170	2 x	–	–	–	–	–	–	1 x
DILM80 – DILM170	2 x	–	–	–	–	–	1 x	–
DILM80 – DILM170	–	–	2 x	–	–	1 x	–	–
DILM80 – DILM170	–	–	2 x	–	1 x	–	–	–
DILM185A – DILM225A	2 x	–	2 x	–	–	–	–	–
DILM185A – DILM225A	2 x	–	–	–	–	–	–	–
DILM250 – DILM1600	–	2 x	–	2 x	–	–	–	–
DILM1200 – DILM2600	–	2 x	–	2 x	–	–	–	–

Notes

Side mounting auxiliary contacts

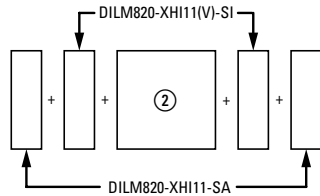
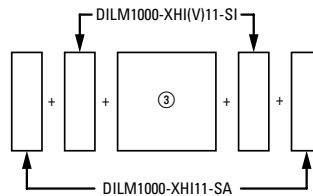
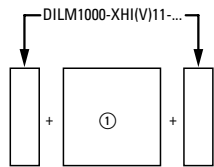

- ① DILM40 – DILM72
- ② DILM250 – DILH2600
- ③ DILM80 – DILM225A

Interlocked opposing contacts according to IEC/EN 60947-5-1 appendix L, inside the auxiliary contact modules (no NO early-makes and no NC late-breaks).

Auxiliary contacts can be used as mirror contacts according to IEC/EN 60947-4-1 Appendix F (not N/C late open). No mechanical interlock is possible between two contactors with auxiliary contacts.

2 auxiliary contacts DILM820-XHI11-SI are already built into the contactors DILM250 to DILH2600/22.
2 DILM1000-XHI11-SI auxiliary contacts are already installed in DILM185A and DILH225A contactors.

Product Selection

Rated operational current	max. Motor rating for three-phase motors 50 - 60 Hz						Conventional thermal current, 3-pole 50 - 60 Hz AC-1 at 40 °C open	Contact configuration
	AC-3			AC-4				
380 V 400 V	220 V 230 V	380 V 400 V	660 V 690 V	220 V 230 V	380 V 400 V	660 V 690 V	$I_{th} = I_e$	Contact configuration: ⊕ = safety function, by positive opening to IEC/EN 60947-5-1 N/O = normally open N/C = normally closed contact
I_e	P	P	P	P	P	P	A	
A	kW	kW	kW	kW	kW	kW	A	

Safety contactors

Screw terminals, 3-pole
 Auxiliary contact element connected non-removable from basic device (manual activation not possible)
 Interlocked opposing contacts according to IEC/EN 60947-5-1 appendix L, inside the auxiliary contact modules, also for the integrated auxiliary contacts of the basic devices

With mirror contact

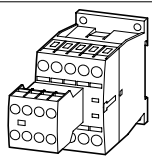

7	2.2	3	3.5	1	2.2	2.9	22	2 N/O	3 N/C
9	2.5	4	4.5	1.5	2.5	3.6	22		
12	3.5	5.5	6.5	2	3	4.4	22		

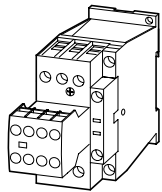

18	5	7.5	11	2.5	4.5	6.5	40		
25	7.5	11	14	3.5	6	8.5	45		
32	10	15	17	4	7	10	45		

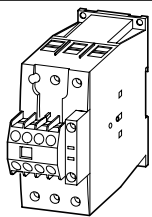

40	12.5	18.5	23	5	9	12	60	2 N/O	2 N/C
50	15.5	22	30	6	10	14	80		
65	20	30	35	7	12	17	98		

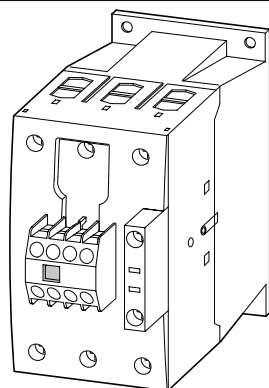

80	25	37	63	12	20	26	110		
95	30	45	75	16	26	35	130		
115	37	55	90	17	28	43	160		
150	48	75	96	20	33	48	190		

Circuit symbol	AC operation Type Article no.	DC operation Type Article no.	Std. pack	Notes
	DILMS7-23(110V50HZ,120V60HZ) 191701		1 pc.	AC-1: Non-inductive or slightly inductive loads, resistance furnaces. AC-3: Normal AC induction motors: Starting, switching off while running. AC-4: Normal AC induction motors: Starting, using counter-current for braking, reversing, inching. Contacts according to EN 50012. RAC120: 110 - 120 V 50/60 Hz RAC240: 190 - 240 V 50/60 Hz RDC24: 24 - 27 V DC ¹⁾ Integrated suppressor circuit in actuating electronics. ²⁾ Integrated varistor suppressor circuit.
	DILMS7-23(230V50HZ,240V60HZ) 191740	DILMS7-23(24VDC)²⁾ 191761		
	DILMS9-23(110V50HZ,120V60HZ) 191702			
	DILMS9-23(230V50HZ,240V60HZ) 191741	DILMS9-23(24VDC)²⁾ 191762		
	DILMS12-23(110V50HZ,120V60HZ) 191703			
	DILMS12-23(230V50HZ,240V60HZ) 191742	DILMS12-23(24VDC)²⁾ 191709		
	DILMS17-23(110V50HZ,120V60HZ) 191704			
	DILMS17-23(230V50HZ,240V60HZ) 191743	DILMS17-23(RDC24)¹⁾ 191710		
	DILMS25-23(110V50HZ,120V60HZ) 191705			
	DILMS25-23(230V50HZ,240V60HZ) 191744	DILMS25-23(RDC24)¹⁾ 191711		
	DILMS32-23(110V50HZ,120V60HZ) 191706			
	DILMS32-23(230V50HZ,240V60HZ) 191745	DILMS32-23(RDC24)¹⁾ 191712		
		DILMS40-22(110V50HZ,120V60HZ) 191707		
DILMS40-22(230V50HZ,240V60HZ) 191746		DILMS40-22(RDC24)¹⁾ 191713		
DILMS50-22(110V50HZ,120V60HZ) 191708				
DILMS50-22(230V50HZ,240V60HZ) 191747		DILMS50-22(RDC24)¹⁾ 191714		
DILMS65-22(110V50HZ,120V60HZ) 191727				
DILMS65-22(230V50HZ,240V60HZ) 191748		DILMS65-22(RDC24)¹⁾ 191715		
DILMS80-22(110V50HZ,120V60HZ) 191728				
DILMS80-22(230V50HZ,240V60HZ) 191749		DILMS80-22(RDC24)¹⁾ 191716		
DILMS95-22(110V50HZ,120V60HZ) 191729				
DILMS95-22(230V50HZ,240V60HZ) 191750		DILMS95-22(RDC24)¹⁾ 191717		
DILMS115-22(RAC120)¹⁾ 191730				
DILMS115-22(RAC240)¹⁾ 191751		DILMS115-22(RDC24)¹⁾ 191718		
DILMS150-22(RAC120)¹⁾ 191731				
DILMS150-22(RAC240)¹⁾ 191752	DILMS150-22(RDC24)¹⁾ 191719			

Rated operational current	max. Motor rating for three-phase motors 50 - 60 Hz						Conventional thermal current, 3-pole 50 - 60 Hz AC-1 at 40 °C open $I_{th} = I_e$	Contact configuration	
	AC-3			AC-4				Contact configuration: ⊕ = safety function, by positive opening to IEC/EN 60947-5-1	
380 V 400 V	220 V 230 V	380 V 400 V	660 V 690 V	220 V 230 V	380 V 400 V	660 V 690 V		N/O = normally open	N/C = normally closed contact
I_e	P	P	P	P	P	P	A		
A	kW	kW	kW	kW	kW	kW	A		

Safety contactors

With two electronically compatible microswitches 1 N/O + 1 N/C; 3-pole
 Auxiliary contact element connected non-removable from basic device (manual activation not possible)
 Interlocked opposing contacts according to IEC/EN 60947-5-1 appendix L, inside the auxiliary contact modules, also for the integrated auxiliary contacts of the basic devices
 Not for microswitches

With mirror contact(not for microswitches)

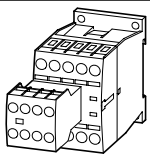

7	2.2	3	3.5	1	2.2	2.9	22	2 N/O	3 N/C
9	2.5	4	4.5	1.5	2.5	3.6	22		
12	3.5	5.5	6.5	2	3	4.4	22		

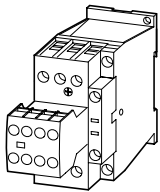

18	5	7.5	11	2.5	4.5	6.5	40		
25	7.5	11	14	3.5	6	8.5	45		
32	10	15	17	4	7	10	45		

Notes

AC-1: Non-inductive or slightly inductive loads, resistance furnaces
 AC-3: Normal AC induction motors: Starting, switching off while running
 AC-4: Normal AC induction motors: Starting, using counter-current for braking, reversing, inching
 Contacts according to EN 50012.
 RAC120: 110 - 120 V 50/60 Hz
 RAC240: 190 - 240 V 50/60 Hz
 RDC24: 24 - 27 V DC

¹⁾ Integrated suppressor circuit in actuating electronics

²⁾ Integrated varistor suppressor circuit



Also suitable for motors with efficiency class IE3.
 IE3-ready devices are identified by the logo on their packaging.

Circuit symbol	AC operation Type Article no.	DC operation Type Article no.	Std. pack
----------------	--	--	-----------

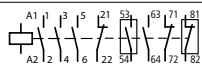

DILMS7-R23(110V50HZ,120V60HZ) 191733		1 pc.
DILMS7-R23(230V50HZ,240V60HZ) 191754	DILMS7-R23(24VDC)⁽²⁾ 191721	
DILMS9-R23(110V50HZ,120V60HZ) 191734		
DILMS9-R23(230V50HZ,240V60HZ) 191755	DILMS9-R23(24VDC)⁽²⁾ 191722	
DILMS12-R23(110V50HZ,120V60HZ) 191735		
DILMS12-R23(230V50HZ,240V60HZ) 191756	DILMS12-R23(24VDC)⁽²⁾ 191723	
DILMS17-R23(110V50HZ,120V60HZ) 191736		
DILMS17-R23(230V50HZ,240V60HZ) 191757	DILMS17-R23(RDC24)⁽¹⁾ 191724	
DILMS25-R23(110V50HZ,120V60HZ) 191737		
DILMS25-R23(230V50HZ,240V60HZ) 191758	DILMS25-R23(RDC24)⁽¹⁾ 191725	
DILMS32-R23(110V50HZ,120V60HZ) 191738		
DILMS32-R23(230V50HZ,240V60HZ) 191759	DILMS32-R23(RDC24)⁽¹⁾ 191726	

Information relevant for export to North America



Product standards	IEC/EN 60947-4-1; UL 508; CSA-C22.2 No. 14-05; CE marking
NA Certification	Request filed for UL and CSA

DILK contactors for capacitors

1

Three-phase capacitors
50 – 60 Hz

Circuit symbol

Type
Article no.

Std. pack

AC-6b, open

230 V	400 V	525 V	690 V
Q	Q	Q	Q
kvar	kvar	kvar	kvar

Contactors for power factor correction

with series resistors

7.5	12.5	16.7	20
11	20	25	33.3
15	25	33.3	40
20	33.3	40	55
25	50	65	85

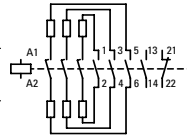

DILK12-11(230V50HZ,240V60HZ)
293988

1 pc.

DILK20-11(230V50HZ,240V60HZ)
294010

DILK25-11(230V50HZ,240V60HZ)
294032

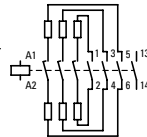

DILK33-10(230V50HZ,240V60HZ)
294054

DILK50-10(230V50HZ,240V60HZ)
294076

Notes

In the case of group compensation multi-stage capacitor banks are connected to the mains, as required. Transient currents of up to $180 \times I_e$ could flow between the capacitors.

The capacitors are pre-charged via the early-make auxiliary contacts and the fitted wire resistors, thereby reducing the inrush current. The main contacts then close after a time lag and carry the continuous current.

The contactors for capacitors are weld-resistant with inrush current peaks up to $180 \times I_e$ due to their special contacts.

DILK... cannot be combined with other auxiliary contacts.

For the switching of reactive-power compensation equipment, please see engineering notes on "power factor correction"

→ Page 1/55 .

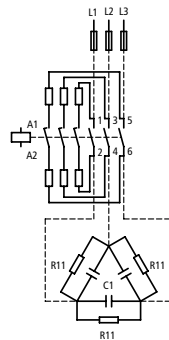

Accessories

Accessories

Page

→ 1/66

Further actuating voltages

→ 1/89

Information relevant for export to North America



Product standards	IEC/EN 60947-4-1; UL 60947-4-1; CSA-C22.2 No. 60947-4-1; CE marking
UL File No.	E29096
UL CCN	NLDX
CSA File No.	012528
CSA Class No.	3211-04
NA Certification	UL Listed, CSA certified

DILM, DILK contactors for power factor correction

Engineering

1

Type	Page	Switch rating			
		230 V	400 V 420 V 440 V	525 V	690 V
		kvar	kvar	kvar	kvar
Individual compensation, open version					
DILM7-...(…)	→ 1/24	1.5	3	3.5	5
DILM9-...(…)	→ 1/24	2	4	4.5	6
DILM12-...(…)	→ 1/24	2.5	4.5	5.5	7
DILM15-...(…)	→ 1/24	2.5	4.5	5.5	7
DILM17-...(…)	→ 1/24	6.5	12	14.5	19
DILM25-...(…)	→ 1/24	7	13.5	16	21
DILM32-...(…)	→ 1/24	7.5	14.5	17	22.5
DILM40(…)	→ 1/26	11	20.5	24.5	32
DILM50(…)	→ 1/26	11.5	22	26	34.5
DILM65(…)	→ 1/26	12.5	23.5	28	37
DILM80(…)	→ 1/26	16	30.5	36.5	48
DILM95(…)	→ 1/26	18	34	41	54
DILM115(…)	→ 1/26	24	46	54.5	72
DILM150(…)	→ 1/26	28	53	63.5	83.5
DILM185A(…)	→ 1/38	87	150	190	150
DILM300A(…)	→ 1/38	115	200	265	200
DILM580(…)	→ 1/38	175	300	400	300
Group compensation, with choke, open version					
DILM7-...(…)	→ 1/24	4	7	7.5	12
DILM9-...(…)	→ 1/24	5	8	10	14
DILM12-...(…)	→ 1/24	5.5	10	12	16
DILM15-...(…)	→ 1/24	5.5	10	12	16
DILM17-...(…)	→ 1/24	7.5	18	20	28
DILM25-...(…)	→ 1/24	10	20	23	30
DILM32-...(…)	→ 1/24	12.5	25	25	32
DILM40(…)	→ 1/26	15	30	30	40
DILM50(…)	→ 1/26	20	40	40	48
DILM65(…)	→ 1/26	25	50	50	57
DILM80(…)	→ 1/26	30	60	70	90
DILM95(…)	→ 1/26	35	70	80	104
DILM115(…)	→ 1/26	50	95	100	125
DILM150(…)	→ 1/26	55	115	115	152
DILM185A(…)	→ 1/38	80	150	200	260
DILM225A(…)	→ 1/38	100	175	230	300
DILM250(…)	→ 1/38	110	190	260	340
DILM300A(…)	→ 1/38	130	225	290	390
DILM400(…)	→ 1/38	160	280	370	480
DILM500(…)	→ 1/38	220	390	500	680
Group compensation, without choke, open version					
DILK12-...(…)	→ 1/54	7.5	12.5	16.7	20
DILK20-...(…)	→ 1/54	11	20	25	33.3
DILK25-...(…)	→ 1/54	15	25	33.3	40
DILK33-...(…)	→ 1/54	20	33.3	40	55
DILK50-...(…)	→ 1/54	25	50	65	85
DILM185A(…)	→ 1/38	66	115	145	115
DILM300A(…)	→ 1/38	85	150	195	150
DILM580(…)	→ 1/38	145	250	333	250

Notes

Use of the contactor DILM without series resistance for group compensation

When using the contactors for group compensation in a system without chokes, each capacitor must have a minimum inductance of approx. 6 µH to limit the peak inrush current. This means an air coil with 5 windings, with a coil diameter of approx. Ø 140 mm. The conductor cross-section must be designed in accordance with the rated operational current for each phase.

1

Product Selection

Rated operational current		AC-5b operation		Conventional thermal current, 3-pole AC-1 at 60 °C open	Contact sequence	Type Article no.	Std. pack
AC-5a operation		AC-5b operation					
220 V	380 V	220 V	380 V				
230 V	400 V	230 V	400 V				
I_e	I_e	I_e	I_e	$I_{th} = I_e$			
A	A	A	A	A			

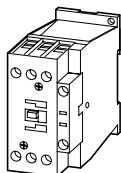

Lighting contactors DILL							
12	12	14	14	24		DILL12(230V50HZ,240V60HZ) 104402	1 pc.
						DILL12(24V50HZ) 104401	
						DILL12(400V50HZ,440V60HZ) 104403	
18	18	21	21	35		DILL18(230V50HZ,240V60HZ) 104405	
						DILL18(24V50HZ) 104404	
						DILL18(400V50HZ,440V60HZ) 104406	
20	20	27	27	40		DILL20(230V50HZ,240V60HZ) 104408	
						DILL20(24V50HZ) 104407	
						DILL20(400V50HZ,440V60HZ) 104409	

Notes DILL do not have an integrated auxiliary contact. They can be combined with DILM32-XHI... and DILA-XHI... auxiliary contacts.

Switchgear for lighting systems → Page 1/57

Information relevant for export to North America



Product standards	IEC/EN 60947-4-1; UL 60947-4-1; CSA-C22.2 No. 60947-4-1; CE marking
UL File No.	E29096
UL CCN	NLDX
CSA File No.	012528
CSA Class No.	3211-04
NA Certification	UL Listed, CSA certified

Engineering

	DIL	L12	L18	L20	M7	M9	M12	M17	M25	M32	M40	M50
Permissible compensation capacitance	C_{max} [mF]	470	470	470	47	80	100	220	330	470	470	500
filament lamp	I_e [A]	14	21	27	6	7.5	10	14	21	27	33	42
Mercury blended lamps	I_e [A]	12	16	23	5	6.5	8.5	12	16	23	30	38
Fluorescent lamps, Conventional choke starter switching	I_e [A]	20	26	35	9	10	15	20	26	35	41	45
Fluorescent lamps, duo circuit (series compensated)	I_e [A]	20	26	35	5.5	8	13	15	22.5	29	36	47
Electronic upstream devices and LED lamps	I_e [A]	12	18	20	5	6.5	8.5	12	17.5	22.5	28	35
High-pressure mercury-arc lamps	I_e [A]	12	18	20	3.5	6	10	12	17.5	20	25	30
Halogen metal vapour lamp	I_e [A]	12	18	20	3.5	6	10	12	17.5	20	25	30
Sodium metal vapour arc lamps	I_e [A]	12	18	20	3.5	6	10	12	17.5	20	25	30
Low-pressure sodium lamps	I_e [A]	7.5	10	12	3	4	6	7.5	10	12	15	22

	DIL	M65	M80	M95	M115	M150	M185A	M225A	M250	M300A	M400	M500
Permissible compensation capacitance	C_{max} [mF]	500	550	620	830	970	2055	2300	2600	3000	3250	3500
filament lamp	I_e [A]	55	67	79	95	125	153	187	208	249	332	415
Mercury blended lamps	I_e [A]	45	65	67	80	110	123	150	167	200	266	332
Fluorescent lamps, Conventional choke starter switching	I_e [A]	55	95	100	125	145	207	237	263	300	375	525
Fluorescent lamps, duo circuit (series compensated)	I_e [A]	59	71	95	100	138	186	213	236	270	338	473
Electronic upstream devices and LED lamps	I_e [A]	45.5	56	66.5	80.5	105	130	158	175	210	280	350
High-pressure mercury-arc lamps	I_e [A]	36	55	60	80	95	138	158	175	200	250	350
Halogen metal vapour lamp	I_e [A]	36	55	60	80	95	138	158	175	200	250	350
Sodium metal vapour arc lamps	I_e [A]	36	55	60	80	95	138	158	175	200	250	350
Low-pressure sodium lamps	I_e [A]	25	35	40	50	70	100	111	123	140	175	245

Notes

In compensated lamps, the sum of the capacitances must not exceed the contactors' max. permissible capacitor load (C_{max})! The values in the table are for each individual contactor contact.

Product Selection

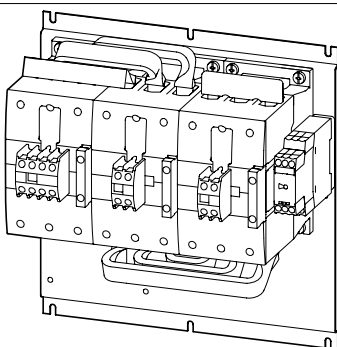
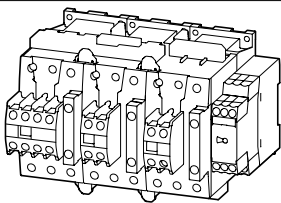
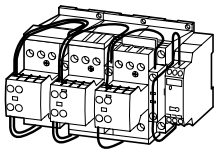
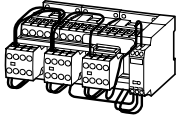

Rated operational current AC-3	max. Motor rating three-phase motors 50 - 60 Hz AC-3					Type Article no.	Std. pack
	380 V 400 V	220 V 230 V	380 V 400 V	500 V	660 V 690 V		
I_e A	P kW	P kW	P kW	P kW	P kW		
Star-delta combinations SDAINL							
Switching frequency: max. 30 starts/hour; max. Changeover time: 20 s							
12	3	5.5	5.5	5.5	SDAINLM12(230V50HZ,240V60HZ) 278286	1 pc.	
12	3	5.5	5.5	5.5	SDAINLM12(400V50HZ) 101380		
12	3	5.5	5.5	5.5	SDAINLM12(24VDC) 100416		
16	4	7.5	7.5	7.5	SDAINLM16(230V50HZ,240V60HZ) 278311		
16	4	7.5	7.5	7.5	SDAINLM16(400V50HZ) 101381		
16	4	7.5	7.5	7.5	SDAINLM16(24VDC) 100417		
22	5.5	11	11	11	SDAINLM22(230V50HZ,240V60HZ) 278336		
22	5.5	11	11	11	SDAINLM22(400V50HZ) 101382		
22	5.5	11	11	11	SDAINLM22(24VDC) 100418		
30	7.5	15	18.5	18.5	SDAINLM30(230V50HZ,240V60HZ) 278361		
30	7.5	15	18.5	18.5	SDAINLM30(400V50HZ) 101383		
30	7.5	15	18.5	18.5	SDAINLM30(RDC24) 100419		
45	11	22	30	22	SDAINLM45(230V50HZ,240V60HZ) 278386		
45	11	22	30	22	SDAINLM45(400V50HZ) 101384		
45	11	22	30	22	SDAINLM45(RDC24) 100420		
55	15	30	37	30	SDAINLM55(230V50HZ,240V60HZ) 278411		
55	15	30	37	30	SDAINLM55(400V50HZ) 101385		
55	15	30	37	30	SDAINLM55(RDC24) 100421		
70	18.5	37	45	37	SDAINLM70(230V50HZ,240V60HZ) 239895		
70	18.5	37	45	37	SDAINLM70(400V50HZ) 101386		
90	22	45	55	45	SDAINLM90(230V50HZ,240V60HZ) 239937		
115	30	55	75	55	SDAINLM115(230V50HZ,240V60HZ) 239963		
140	37	75	90	90	SDAINLM140(230V50HZ,240V60HZ) 240009		
165	45	90	110	132	SDAINLM165(230V50HZ,240V60HZ) 240035		
200	55	110	132	160	SDAINLM200(230V50HZ,240V60HZ) 101010		
260	75	132	160	160	SDAINLM260(230V50HZ,240V60HZ) 101031		

Individual components of the combination				Spare auxiliary contacts			Notes
Mains contactor Q11	Delta contactor Q15	Star contactor Q13	Timing relays K1	Q11	Q13	Q15	

Type Type Type Type

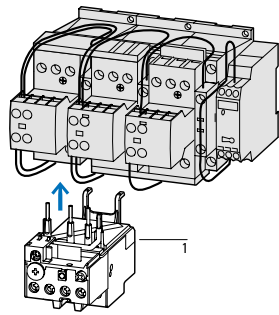
DILM7-10 + DILA-XHI20	DILM7-01 + DILA-XHI20	DILM7-01 + DILA-XHI20	ETR4-51				<p>IE3 ✓</p> <p>Also suitable for motors with efficiency class IE3. IE3-ready devices are identified by the logo on their packaging.</p> <p>Main circuit: Depending on the type of coordination required (i.e. Type "1" or Type "2") it must be established whether the fuse protection and the input wiring for the mains contactor and delta contactor are to be common or separate.</p> <p>The following applies for SDAINLM 140 – SDAINLM 260: On the mounting plate.</p> <p>Circuit diagrams, star-delta combinations → Page 1/60</p> 
DILM7-10 + DILA-XHI20	DILM7-01 + DILA-XHI20	DILM7-01 + DILA-XHI20	ETR4-51				
DILM7-10 + DILA-XHI20	DILM7-01 + DILA-XHI20	DILM7-01 + DILA-XHI20	ETR4-51				
DILM9-10 + DILA-XHI20	DILM9-01 + DILA-XHI20	DILM7-01 + DILA-XHI20	ETR4-51				
DILM9-10 + DILA-XHI20	DILM9-01 + DILA-XHI20	DILM7-01 + DILA-XHI20	ETR4-51				
DILM9-10 + DILA-XHI20	DILM9-01 + DILA-XHI20	DILM7-01 + DILA-XHI20	ETR4-51				
DILM12-10 + DILA-XHI20	DILM12-01 + DILA-XHI20	DILM7-01 + DILA-XHI20	ETR4-51				
DILM12-10 + DILA-XHI20	DILM12-01 + DILA-XHI20	DILM7-01 + DILA-XHI20	ETR4-51				
DILM12-10 + DILA-XHI20	DILM12-01 + DILA-XHI20	DILM7-01 + DILA-XHI20	ETR4-51				
DILM17-10 + DILA-XHI20	DILM17-01 + DILA-XHI20	DILM17-01 + DILA-XHI20	ETR4-51				
DILM17-10 + DILA-XHI20	DILM17-01 + DILA-XHI20	DILM17-01 + DILA-XHI20	ETR4-51				
DILM17-10 + DILA-XHI20	DILM17-01 + DILA-XHI20	DILM17-01 + DILA-XHI20	ETR4-51				
DILM25-10 + DILA-XHI20	DILM25-01 + DILA-XHI20	DILM17-01 + DILA-XHI20	ETR4-51				
DILM25-10 + DILA-XHI20	DILM25-01 + DILA-XHI20	DILM17-01 + DILA-XHI20	ETR4-51				
DILM25-10 + DILA-XHI20	DILM25-01 + DILA-XHI20	DILM17-01 + DILA-XHI20	ETR4-51				
DILM32-10 + DILA-XHI20	DILM32-01 + DILA-XHI20	DILM25-01 + DILA-XHI20	ETR4-51				
DILM32-10 + DILA-XHI20	DILM32-01 + DILA-XHI20	DILM25-01 + DILA-XHI20	ETR4-51				
DILM32-10 + DILA-XHI20	DILM32-01 + DILA-XHI20	DILM25-01 + DILA-XHI20	ETR4-51				
DILM40 + DILM150-XHI31	DILM40 + DILM150-XHI11	DILM40 + DILM150-XHI11	ETR4-51				
DILM40 + DILM150-XHI31	DILM40 + DILM150-XHI11	DILM40 + DILM150-XHI11	ETR4-51				
DILM50 + DILM150-XHI31	DILM50 + DILM150-XHI11	DILM40 + DILM150-XHI11	ETR4-51				
DILM65 + DILM150-XHI31	DILM65 + DILM150-XHI11	DILM40 + DILM150-XHI11	ETR4-51				
DILM80 + DILM150-XHI31	DILM80 + DILM150-XHI11	DILM50 + DILM150-XHI11	ETR4-51				
DILM95 + DILM150-XHI31	DILM95 + DILM150-XHI11	DILM65 + DILM150-XHI11	ETR4-51				
DILM115... + DILM150-XHI31	DILM115 + DILM150-XHI11	DILM80 + DILM150-XHI11	ETR4-51				
DILM150... + DILM150-XHI31	DILM150 + DILM150-XHI11	DILM95 + DILM150-XHI11	ETR4-51				

Accessories
1 Overload relays
Accessories

Page
→ 2/8
→ 1/66

Engineering

Circuit diagrams, Star-delta combinations

SDAINLM12 – SDAINLM55

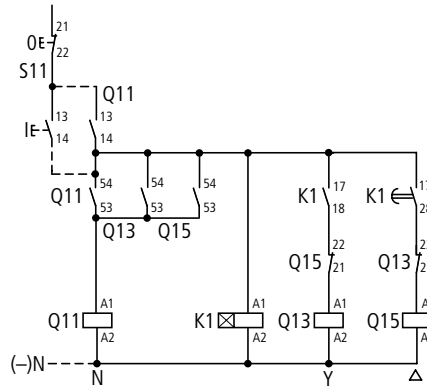
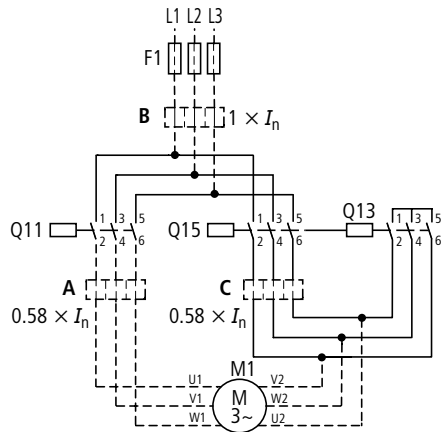

SDAINLM70 – SDAINLM260

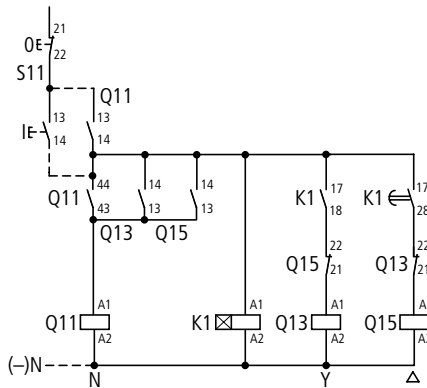
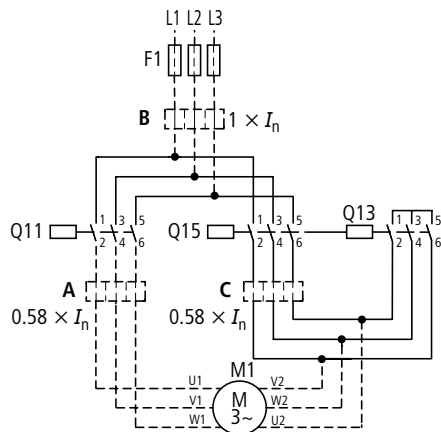

Overload relay settings

A: $0.58 \times I_n$
Motor protected in Y and Δ - positions

B: $1 \times I_n$
Motor not protected in Y position

C: $0.58 \times I_n$
Motor not protected in Y position

Timing relay set to approx. 10 s

Main circuit:

Depending on the type of coordination required (i.e. Type "1" or Type "2") it must be established whether the fuse protection and the input wiring for the mains contactor and delta contactor are to be common or separate.

Starting

≤ 15 s

15 - 40 s

> 40 s

Components for self-assembly of star-delta combinations

max. Motor rating
three-phase motors 50 - 60 Hz

Individual components of the combination

Spare auxiliary contacts

AC-3					Changeover time ¹⁾			Coils according to EN 50005 contacts according to EN 50005 and EN 50012				Q11	Q15	Q13
230 V	400 V	500 V	690 V	1000 V	up to 12 s	up to 20 s	up to 30 s	Mains contactor Q11	Delta contactor Q15	Star contactor Q13	Timing relay K1			
kW	kW	kW	kW	kW				Part no. DIL	Part no. DIL	Part no. DIL	Type			
90	160	200	250	132	✓	✓	✓	M185A/22	M185A/22	M115/22 ²⁾	ETR4-51			
110	200	250	315	160	✓	✓	–	M225A/22	M225A/22	M115/22 ²⁾	ETR4-51			
132	250	315	400	200	✓	✓	✓	M250/22	M250/22	M185A/22	ETR4-51			
160	300	355	450	200	✓	✓	✓	M300A/22	M300A/22	M185A/22	ETR4-51			
200	355	450	560	220	✓	✓	–	M400/22	M400/22	M250/22	ETR4-51			
250	450	560	600	220	✓	✓	✓	M500/22	M500/22	M300A/22	ETR4-51			
300	560	710	900	355	✓	✓	✓	M580/22	M580/22	M400/22	ETR4-51			
350	630	750	950	355	✓	✓	✓	M650/22	M650/22	M400/22	ETR4-51			
400	710	900	1200	1400	✓	✓	✓	M750/22	M750/22	M580/22	ETR4-51			
450	800	950	1300	1400	✓	✓	✓	M820/22	M820/22	M580/22	ETR4-51			
560	1000	1200	1700	1700	✓	✓	–	M1000/22	M1000/22	M650/22	ETR4-51			

Notes ¹⁾ Longer changeover times upon request
²⁾ Use DILM185A at 1000 V

Components for self-assembly

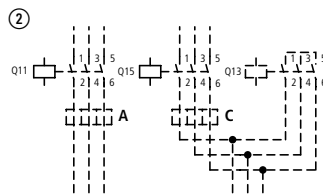
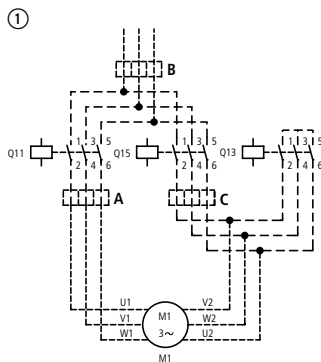

Overload relay settings

A: $0.58 \times I_n$
Motor protected in Y and Δ - positions

B: $1 \times I_n$
Motor not protected in Y position

C: $0.58 \times I_n$
Motor not protected in Y position

Starting

≤ 15 s

15 - 40 s

> 40 s

Timing relay set to approx. 10 s

Main circuit:

Depending on the type of coordination required (i.e. type "1" or type "2") it must be established whether the fuse protection and the input wiring for the mains contactor and delta contactor are to be ① common or ② separate.

Control circuit:

If the combinations are to be used within the scope of IEC/EN 60 204-1, VDE 0113 Part 1, then Point 9.1.1 regarding the "supply of control circuits", must be observed.

Product Selection

Rated operational current	max. Motor rating three-phase motors 50 - 60 Hz						Type Article no.
	AC-3			AC-4			
380 V	220 V	380 V	660 V	220 V	380 V	660 V	
400 V	230 V	400 V	690 V	230 V	400 V	690 V	
I_e	P	P	P	P	P	P	
A	kW	kW	kW	kW	kW	kW	

DIUL reversing combinations

Contactors combinations for starting motors with two directions of rotation

AC operation 230 V 50 Hz, 240 V 60 Hz

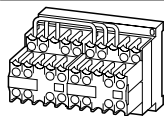

IE3 ✓

9	2.2	4	4	1.5	3	3	DIULEM/21/MV(230V50HZ,240V60HZ) 051849
---	-----	---	---	-----	---	---	--

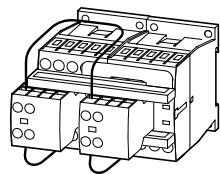

IE3 ✓

7	2.2	3	3.5	1	2.2	2.9	DIULM7/21(230V50HZ,240V60HZ) 278061
9	2.5	4	4.5	1.5	2.5	3.6	DIULM9/21(230V50HZ,240V60HZ) 278086
12	3.5	5.5	6.5	2	3	4.4	DIULM12/21(230V50HZ,240V60HZ) 278111

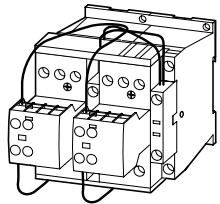

IE3 ✓

18	5	7.5	11	2.5	4.5	6.5	DIULM17/21(230V50HZ,240V60HZ) 278136
25	7.5	11	14	3.5	6	8.5	DIULM25/21(230V50HZ,240V60HZ) 278161
32	10	15	17	4	7	10	DIULM32/21(230V50HZ,240V60HZ) 278186
40	12.5	18.5	23	5	9	12	DIULM40/11(230V50HZ,240V60HZ) 278211
50	15.5	22	30	6	10	14	DIULM50/11(230V50HZ,240V60HZ) 278236
65	20	30	35	7	12	17	DIULM65/11(230V50HZ,240V60HZ) 278261

DC operation 24 V DC

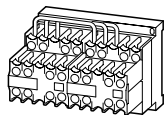

IE3 ✓

9	2.2	4	4	1.5	3	3	DIULEM/21/MV-G(24VDC) 214655
---	-----	---	---	-----	---	---	--

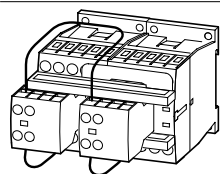

IE3 ✓

7	2.2	3	3.5	1	2.2	2.9	DIULM7/21(24VDC) 107021
9	2.5	4	4.5	1.5	2.5	3.6	DIULM9/21(24VDC) 107022
12	3.5	5.5	6.5	2	3	4.4	DIULM12/21(24VDC) 107023

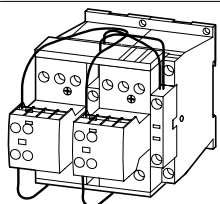

IE3 ✓

18	5	7.5	11	2.5	4.5	6.5	DIULM17/21(RDC24) 107024
25	7.5	11	14	3.5	6	8.5	DIULM25/21(RDC24) 107025
32	10	15	17	4	7	10	DIULM32/21(RDC24) 107026

Notes

AC-3: Normal AC induction motors: Starting, switching off while running
AC-4: Normal AC induction motors: Starting, using counter-current for braking, reversing, inching



Also suitable for motors with efficiency class IE3.
IE3-ready devices are identified by the logo on their packaging.

Std. pack	Individual components of the combination		Spare auxiliary contacts		Wiring diagram	Notes
	Contactor Q11	Contactor Q12	Q11	Q12		
Type	Type					
1 pc. 	DILEM-10 + 11DILEM	DILEM-10 + 11DILEM				<p>Accessories</p> <p>1 Overload relays → 2/8</p> <p>Accessories → 1/66</p> <p>Reversing contactors</p> <p>All devices with mechanical interlock</p>
	DILM7-01 + DILA-XHI20	DILM7-01 + DILA-XHI20				
	DILM9-01 + DILA-XHI20	DILM9-01 + DILA-XHI20				
	DILM12-01 + DILA-XHI20	DILM12-01 + DILA-XHI20				
	DILM17-01 + DILA-XHI20	DILM17-01 + DILA-XHI20				
	DILM25-01 + DILA-XHI20	DILM25-01 + DILA-XHI20				
	DILM32-01 + DILA-XHI20	DILM32-01 + DILA-XHI20				
	DILM40 + DILM150-XHI11	DILM40 + DILM150-XHI11				
	DILM50 + DILM150-XHI11	DILM50 + DILM150-XHI11				
	DILM65 + DILM150-XHI11	DILM65 + DILM150-XHI11				
1 pc. 	DILEM-10-G + 11DILEM	DILEM-10-G + 11DILEM				
	DILM7-01 + DILA-XHI20	DILM7-01 + DILA-XHI20				
	DILM9-01 + DILA-XHI20	DILM9-01 + DILA-XHI20				
	DILM12-01 + DILA-XHI20	DILM12-01 + DILA-XHI20				
	DILM17-01 + DILA-XHI20	DILM17-01 + DILA-XHI20				
	DILM25-01 + DILA-XHI20	DILM25-01 + DILA-XHI20				
	DILM32-01 + DILA-XHI20	DILM32-01 + DILA-XHI20				

Information relevant for export to North America

Product standards	IEC/EN 60947-4-1; UL 60947-4-1; CSA-C22.2 No. 60947-4-1-14; CE marking
UL File No.	E29096a
UL CCN	NLDX
CSA File No.	012528
CSA Class No.	3211-04 (DIULM..., DIULEM...)
	2411-03 (DIULM...)
NA Certification	UL listed, CSA certified

DILM...-XSP... suppressor circuits

1

voltage U_s
V

For use with

Circuit symbol

Type Article no.

Std. pack

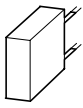

RC suppressors

For AC operation contactors 50 - 60 Hz.
With DC operated contactors and with DILM115 and DILM150 the suppressor is integrated.
Note drop-out delay

24 - 48 AC	DILM7 – DILM15 DILMP20 DILA		DILM12-XSPR48 281199	1 pc.
48 - 130 AC			DILM12-XSPR130 150683	
110 - 240 AC			DILM12-XSPR240 281200	
240 - 500 AC			DILM12-XSPR500 281201	
24 - 48 AC	DILM17 – DILM32 DILK12 – DILK25 DILL... DILMP32-DILMP45		DILM32-XSPR48 281202	
48 - 130 AC			DILM32-XSPR130 150684	
110 - 240 AC			DILM32-XSPR240 281203	
240 - 500 AC			DILM32-XSPR500 281204	
24 - 48 AC	DILM40 – DILM95 DILK33 – DILK50 DILMP63 – DILMP200		DILM95-XSPR48 281205	
48 - 130 AC			DILM95-XSPR130 150685	
110 - 240 AC			DILM95-XSPR240 281206	
240 - 500 AC			DILM95-XSPR500 281207	

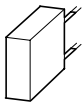

Varistor suppressors

For AC operation contactors 50 - 60 Hz.
With DC operated contactors and with DILM115 and DILM150 the suppressor is integrated.
Note drop-out delay

24 - 48 AC	DILM7 – DILM15 DILMP20 DILA		DILM12-XSPV48 281208	1 pc.
48 - 130 AC			DILM12-XSPV130 281209	
130 - 240 AC			DILM12-XSPV240 281210	
240 - 500 AC			DILM12-XSPV500 281211	
24 - 48 AC	DILM17 – DILM32 DILK12 – DILK25 DILL... DILMP32 – DILMP45		DILM32-XSPV48 281212	
48 - 130 AC			DILM32-XSPV130 281213	
130 - 240 AC			DILM32-XSPV240 281214	
240 - 500 AC			DILM32-XSPV500 281215	
24 - 48 AC	DILM40 – DILM95 DILK33 – DILK50 DILMP63 – DILMP200		DILM95-XSPV48 281216	
48 - 130 AC			DILM95-XSPV130 281217	
130 - 240 AC			DILM95-XSPV240 281218	
240 - 500 AC			DILM95-XSPV500 281219	

Notes

Information relevant for export to North America



Product standards	IEC/EN 60947-4-1; UL 508; CSA-C22.2 No. 14-05; CE marking
UL File No.	E29184
UL CNN	NKCR2, NKCR8
CSA File No.	256465
CSA Class No.	3211-07
NA Certification	UL recognized, CSA certified

voltage U_s
V

For use with

Circuit symbol

Type Article no.

Std. pack

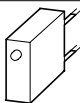

Varistor suppressors

with integrated LED
For AC operation contactors 50 - 60 Hz.
With DC operated contactors and with DILM115 and DILM150 the suppressor is integrated.
Note drop-out delay

24 - 48 AC	DILM7 – DILM15 DILMP20 DILA		DILM12-XSPVL48 281220	1 pc.
130 - 240 AC	DILM7 – DILM12 DILMP20 DILA		DILM12-XSPVL240 281221	
24 - 48 AC	DILM17 – DILM32 DILK12 – DILK25 DILL... DILMP32 – DILMP45		DILM32-XSPVL48 281222	
130 - 240 AC	DILM17 – DILM32 DILK12 – DILK25 DILL... DILMP32 – DILMP45		DILM32-XSPVL240 281223	
24 - 48 AC	DILM40 – DILM95 DILK33 – DILK50 DILMP63 – DILMP200		DILM95-XSPVL48 281224	
130 - 240 AC	DILM40 – DILM95 DILK33 – DILK50 DILMP63 – DILMP200		DILM95-XSPVL240 281225	

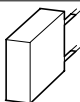

Free-wheel diode suppressor

Additional for integrated suppressor with DC operated contactors.
Prevention of negative switch-off voltage when the contactor is used together with a safety PLC.

12 - 250 DC	DILM7 – DILM15 DILMP20 DILA		DILM12-XSPD 101672	1 pc.
-------------	-----------------------------------	--	------------------------------	-----------

Notes

Information relevant for export to North America



Product standards	IEC/EN 60947-4-1; UL 508; CSA-C22.2 No. 14-05; CE marking
UL File No.	E29184
UL CCN	NKCR2, NKCR8
CSA File No.	256465
CSA Class No.	3211-07
NA Certification	UL recognized, CSA certified

For use with **Type** **Std. pack** **Notes**
Article no.

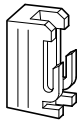

Connectors

For mechanically linking contactor relays in combinations
Contactor distance: 0 mm



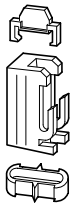

DILM7 – DILM72 **DILM32-XVB¹⁾** 50 pcs. –
DILA 281227  
DILMP32 – DILMP45
DILMP63 – DILMP80
DILMF8 – DILMF65



DILM80 – DILM170 **DILM150-XVB²⁾** 10 pcs. –
DILMP125 – DILMP200 281226  
DILMF80 – DILMF150

Mechanical interlocks



DILM7 – DILM15 **DILM12-XMV³⁾** 1 pc. For two contactors with AC or DC operation arranged vertically or horizontally.
DILMP20 281196  
DILA Distance between contactors 0 mm, including contactor connector
Mechanical lifespan: 2.5 x 10⁶ operations.
DILM 150-XMV including fixing plate for contactors.
Additional auxiliary contact modules possible → Page 1/44

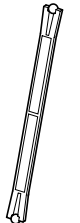

DILM17 – DILM38 **DILM32-XMV⁴⁾**
DILMP32 – DILMP45 281197
DILMF8 – DILMF32

DILM40 – DILM72 **DILM65-XMV⁴⁾**
DILMP63 – DILMP80 281198
DILMF40 – DILMF65

DILM80 – DILM170 **DILM150-XMV⁴⁾**
DILMP125 – DILMP200 240081
DILMF80 – DILMF150

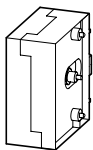

DILM185A **DILM500-XMV⁵⁾**
DILM225A 208289
DILM250
DILM300A
DILM400
DILM500

For contactors with the same or different magnet systems mounted horizontally or vertically, mechanical lifespan 5 x 10⁶ operations. No auxiliary contact permitted between mechanical interlock and contactor.
Contactors DILM250 to DILM500 can be interlocked with each other in all combinations.
Contactors DILM185A and DILM225A can be interlocked with each other in all combinations.
For combinations of DILM185A or DILM225A with DILM250 to DILM500 maintain a 36 mm offset to the fixing plate (see instruction leaflet ILO3406009Z).

DILM580 **DILM820-XMV⁵⁾**
DILM650 208288
DILM750
DILM820
DILM1000

For contactors with the same or different magnet systems mounted horizontally or vertically, mechanical lifespan 5 x 10⁶ operations. No auxiliary contact permitted between mechanical interlock and contactor.
DILM820-XMV consists of interlock element and fixing plate.

Set of spare parts for mechanical interlock















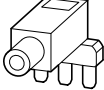

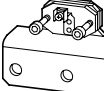
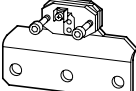



Ball for mechanical interlock, incl. contactor connector.



DILM80 – DILM170 **DILM150-XMVE** 1 pc. UL/CSA certification not required
107020  

Notes Information relevant for export to North America

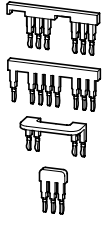

	1)	2)	3)	4)	5)
Product standards	IEC/EN 60947-4-1; UL 508; CSA-C22.2 No. 14-05; CE marking				
UL File No.	E36332	E29184	E29096	E29096	E29184
UL CNN	NLRV	NKCR	NLDX	NLDX	NKCR
CSA File No.	012528	012528	012528	012528	012528
CSA Class No.	3211-05	3211-03	321104	2411-03, 3211-04	3211-04
NA Certification	UL recognized, CSA certified	UL listed, CSA certified	UL listed, CSA certified	UL listed, CSA certified	UL listed, CSA certified

For use with	Contact sequence	Type Article no.	Std. pack	Notes	Information relevant for export to North America
Paralleling links for main contacts					
consisting of 2 paralleling links					
	DILM7 – DILM15 DILMP20	 DILM12-XP1 281193	5 pcs. 	4. Pole can be broken off for DILM12-XP1 AC-1 current carrying capacity of the open contactor increases by a factor of 2.5. Protected against accidental contact in accordance to VDE 0106 part 100 A shroud is included with DILM185-XP1 for the shutter. Terminal capacities for DILM...-XP1 → Technische Daten, Seite 1/116	Product standards IEC/EN 60947-4-1; UL 508; CSA-C22.2 No. 14-05; CE marking E29096 UL File No. UL CCN CSA File No. 012528 CSA Class No. 3211-03 NA Certification UL Listed, CSA certified
	DILM17 – DILM32 DILMF8 – DILMF32	 DILM32-XP1 281194			
	DILM40 – DILM72 DILMF40 – DILMF65	DILM65-XP1 281195	1 pc. 		
	DILM80 – DILM170 DILMF80 – DILMF150	DILM150-XP1 284769			
	DILM185A	DILM185-XP1 208292	1 pc.		
Star-point bridges					
	DILM7 – DILM15	 DILM12-XS1 281190	20 pcs. 	Designed as tool-less plug connection; Use as auxiliary contact DILA-XHIT... → Page 1/46	Product standards IEC/EN 60947-4-1; UL 508; CSA-C22.2 No. 14-05; CE marking E36332 UL File No. NLRV UL CCN 012528 CSA File No. 3211-05 NA Certification UL Listed, CSA certified
	DILM17 – DILM32 DILMF8 – DILMF32	DILM32-XS1 281191		Use as auxiliary contact DILA-XHIT... → Page 1/46	Product standards IEC/EN 60947-4-1; UL 508; CSA-C22.2 No. 14-05; CE marking E36332 UL File No. NLRV UL CCN 012528 CSA File No. 3211-04 NA Certification UL Listed, CSA certified
	DILM40 – DILM72 DILMF40 – DILMF65	DILM65-XS1 281192	10 pcs. 	–	
	DILM80 – DILM170 DILMF80 – DILMF150	DILM150-XS1 284768	5 pcs. 	–	Product standards IEC/EN 60947-4-1; UL 508; CSA-C22.2 No. 14-05; CE marking E36332 UL File No. NLRV UL CCN 012528 CSA File No. 3211-03 NA Certification UL Listed, CSA certified
	DILM185A – DILM400	DILM400-XS1 208291	1 pc. 	A shroud is included for the shutter.	Product standards IEC/EN 60947-4-1; UL 508; CSA-C22.2 No. 14-05; CE marking E36332 UL File No. NLRV UL CCN 012528 CSA File No. 3211-04 NA Certification UL listed, CSA certified
		DILM400-XS1-SPS 107669	100 pcs. 		
	DILM500	DILM500-XS1 208290	1 pc. 	A shroud is included for the shutter.	Product standards IEC/EN 60947-4-1; UL 508; CSA-C22.2 No. 14-05; CE marking E29096 UL File No. UL CNN UL CCN 165628 CSA File No. 3211-04 NA Certification UL listed, CSA certified

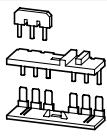
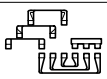
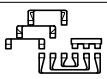
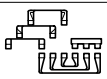
For use with	Type Article no.	Std. pack	Notes	Information relevant for export to North America 	
star-delta wiring kit					
Main current wiring for star-delta combination Including star-point bridge					
	Mains contactors	DILM12-XSL 283130	1 pc. 	Designed as tool-less plug connection; Use as auxiliary contact DILA-XHIT... → Page 1/46 The following control cables are integrated in addition to electrical interlock: Q13: A1 - Q15: 21 Q13: 21 - Q15: A1 Q13: A2 - Q15: A2	Product standards IEC/EN 60947-4-1; UL 508; CSA-C22.2 No. 14-05; CE marking CSA File No. 012528 CSA Class No. 3211-05 NA Certification CSA certified
	DILM7				
	DILM9				
	DILM12				
	DILM15				
	Delta contactors				
	DILM7				
	DILM9				
	DILM12				
	DILM15				
Star contactors					
DILM7					
DILM9					
DILM12					
DILM15					
	Mains contactors	DILM32-XSL 283131		Consists of the jumpers: Mains - delta contactor Delta - star contactor star-point bridge	Product standards IEC/EN 60947-4-1; UL 508; CSA-C22.2 No. 14-05; CE marking UL File No. E36332 UL CCN NLRV CSA File No. 012528 CSA Class No. 3211-04 NA Certification UL Listed, CSA certified
	DILM17				
	DILM25				
	DILM32				
	Delta contactors				
	DILM17				
	DILM25				
	DILM32				
	Star contactors				
	DILM17				
DILM25					
DILM32					
	Mains contactors	DILM65-XSL 101058			
	DILM40				
	DILM50				
	DILM65				
	Delta contactors				
	DILM40				
	DILM50				
	DILM65				
	Star contactors				
	DILM40				
DILM50					
DILM65					
	Mains contactors	DILM95-XSL 101486			Product standards IEC/EN 60947-4-1; UL 508; CSA-C22.2 No. 14-05; CE marking UL File No. E36332 UL CCN NLRV CSA File No. 012528 CSA Class No. 2411-03, 3211-04 NA Certification UL Listed, CSA certified
	DILM80				
	DILM95				
	Delta contactors				
	DILM80				
	DILM95				
	Star contactors				
	DILM50				
	DILM65				
		Mains contactors	DILM150-XSL 101487		
DILM115					
DILM150					
Delta contactors					
DILM115					
DILM150					
Star contactors					
DILM80					
DILM95					
DILM115					

For use with **Type** Article no. **Std. pack** **Notes** **Information relevant for export to North America**



reversing wiring kit

Main current wiring for reversing combinations

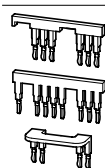

DILM7 DILM9 DILM12	DILM12-XRL 283108	1 pc. 	Designed as tool-less plug connection; Use as auxiliary contact DILA-XHIT... → Page 1/46 The following control cables are integrated in addition to the electrical interlock: Q11: A1 - Q12: 21 Q11: 21 - Q12: A1 Q11: A2 - Q12: A2	Product standards UL File No. UL CCN CSA File No. CSA Class No. NA Certification	IEC/EN 60947-4-1; UL 508; CSA-C22.2 No. 14-05; CE marking E36332 NLRV 012528 3211-05 UL Listed, CSA certified
--------------------------	-----------------------------	-----------	--	---	---

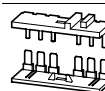

DILM17 DILM25 DILM32 DILMF8 DILMF11 DILMF14 DILMF17 DILMF25 DILMF32	DILM32-XRL 283109			Product standards UL File No. UL CCN CSA File No. CSA Class No. NA Certification	IEC/EN 60947-4-1; UL 508; CSA-C22.2 No. 14-05; CE marking E36332 NLRV 012528 3211-04 UL Listed, CSA certified
---	-----------------------------	--	--	---	---



DILM40 DILM50 DILM65 DILMF40 DILMF50 DILMF65	DILM65-XRL 101057				
DILM80 DILM95 DILM115 DILM150 DILMF80 DILMF95 DILMF115 DILMF150	DILM150-XRL 101681			Product standards UL File No. UL CCN CSA File No. CSA Class No. NA Certification	IEC/EN 60947-4-1; UL 508; CSA-C22.2 No. 14-05; CE marking E36332 NLRV 012528 2411-03, 3211-04 UL Listed, CSA certified

IP2X shrouding set

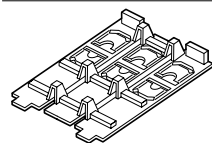

DILM17 DILM25 DILM32 DILM38 DILMP32 DILMP45 DILL... DILMF8 DILMF11 DILMF14 DILMF17 DILMF25 DILMF32	DILM32-XIP2X 118855	1 pc. 	A shrouding set consists of 2 three-pole and 2 one-pole shrouds.	UL/CSA certification not required	
--	-------------------------------	-----------	--	-----------------------------------	--











DILM40 DILM50 DILM65 DILM72 DILMP63 DILMP80 DILMF40 DILMF50 DILMF65	DILM65-XIP2X 106491	8 pcs. 	2 shrouds are necessary per phase The shrouding kit consists of 8 shrouds	UL/CSA certification not required	
---	-------------------------------	------------	--	-----------------------------------	--

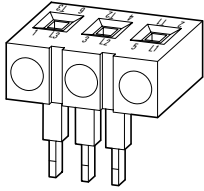

DILM80 DILM95 DILM115 DILM150 DILM170 DILMP125 DILMP160 DILMP200 ZB150 DILMF80 DILMF95 DILMF115 DILMF150	DILM150-XIP2X 106492			UL/CSA certification not required	
--	--------------------------------	--	--	-----------------------------------	--

Accessories

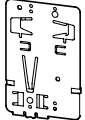
1

For use with	Type Article no.	Std. pack	Notes	Information relevant for export to North America 	
Three-phase commoning links					
Protected against accidental contact, short-circuit-proof, $U_e = 690\text{ V}$, $I_u = 35\text{ A}$ Can be extended by rotating mounting					
	DILM7 DILM9 DILM12 DILM15	DILM12-XDSB0/3 240084	5 pcs. 	Suitable for 3 contactors. Length 112 mm	Product standards IEC/EN 60947-4-1; UL 508; CSA-C22.2 No. 14-05; CE marking UL File No. E36332 UL CCN NLRV CSA File No. 012528 CSA Class No. 2411-03 NA Certification UL Listed, CSA certified
	DILM7 DILM9 DILM12 DILM15	DILM12-XDSB0/4 240085		Suitable for 4 contactors. Length 157 mm	
	DILM7 DILM9 DILM12 DILM15	DILM12-XDSB0/5 240086		Suitable for 5 contactors. Length 202 mm	
Incoming connection block					
	DILM7 DILM9 DILM12 DILM15	DILM12-XEK 240083	5 pcs. 	For three-phase commoning link, protected against accidental contact, $U_e = 690\text{ V}$, $I_u = 35\text{ A}$. Terminal capacities: stranded: 2.5 - 16 mm ² Flexible with ferrule 2.5 - 16 mm ² AWG14 - 8	Product standards IEC/EN 60947-4-1; UL 508; CSA-C22.2 No. 14-05; CE marking UL File No. E36332 UL CCN NLRV CSA File No. 012528 CSA Class No. 2411-03 NA Certification UL Listed, CSA certified
Adapter plate					
Enables latching of contactors onto DIN rails					
	DILM80 DILM95 DILM115 DILM150 DILM170 DILMF80 DILMF95 DILMF115 DILMF150	NZM2-XC75 260215	1 pc. 	For top-hat rail 75 mm	Product standards UL489; CSA-C22.2 No. 5-09; IEC60947, CE marking UL File No. E140305 UL CCN DIHS CSA File No. 022086 CSA Class No. 1437-01 NA Certification UL Listed, CSA certified

Actuating voltage For use with Circuit symbol Time range Type Article no. Std. pack Notes

U_s

Electronic timer modules

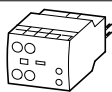

On-delayed
Cannot be combined with top mounting auxiliary contacts
Incl. suppressor circuits

24 V AC/DC	DILM7 – DILM38 DILMP20		0.05 s - 1 s	DILM32-XTEE11(RA24) 101440	1 pc.
100 - 130 V AC 50/60 Hz	DILMP32 – DILMP45 DILA DILMF7		0.5 s - 10 s	DILM32-XTEE11(RAC130) 101441	
200 - 240 V AC 50/60 Hz	DILMF11 DILMF14 DILMF25 DILMF32		5 s - 100 s	DILM32-XTEE11(RAC240) 101442	

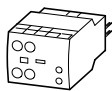

Off-delayed, auxiliary voltage-free
Cannot be combined with top mounting auxiliary contacts
Incl. suppressor circuits

24 V AC/DC	DILM7 – DILM38 DILMP20		0.05 s - 1 s	DILM32-XTED11-1(RA24) 105210	1 pc.
100 - 130 V AC 50/60 Hz	DILMP32 – DILMP45 DILA DILMF7 DILMF11 DILMF14 DILMF25 DILMF32		0.5 s - 10 s	DILM32-XTED11-10(RA24) 104943	
	200 - 240 V AC 50/60 Hz		5 s - 100 s	DILM32-XTED11-100(RA24) 104946	
100 - 130 V AC 50/60 Hz	DILMF25 DILMF32		0.05 s - 1 s	DILM32-XTED11-1(RAC130) 105211	
			0.5 s - 10 s	DILM32-XTED11-10(RAC130) 104944	
			5 s - 100 s	DILM32-XTED11-100(RAC130) 104947	
			0.05 s - 1 s	DILM32-XTED11-1(RAC240) 105212	
200 - 240 V AC 50/60 Hz	DILMF25 DILMF32		0.5 s - 10 s	DILM32-XTED11-10(RAC240) 104945	
			5 s - 100 s	DILM32-XTED11-100(RAC240) 104948	

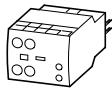

For star-delta applications
Cannot be combined with top mounting auxiliary contacts
Incl. suppressor circuits

24 V AC/DC	DILM7 – DILM38 DILMP20			DILM32-XTEY20(RA24) 101446	1 pc. 	Changeover time: 1 s - 30 s Changeover delay: 50 ms Example of circuits → Page 1/102
100 - 130 V AC 50/60 Hz	DILMP32 – DILMP45 DILA DILMF7			DILM32-XTEY20(RAC130) 101447		
200 - 240 V AC 50/60 Hz	DILMF11 DILMF14 DILMF25 DILMF32			DILM32-XTEY20(RAC240) 101448		

Notes









Information relevant for export to North America

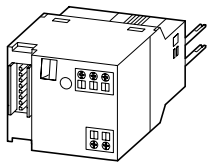

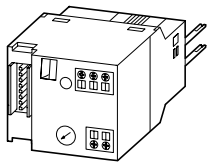
Product standards	IEC/EN 60947-4-1; UL 508; CSA-C22.2 No. 14-05; CE marking
UL File No.	E29184
UL CCN	NKCR
CSA File No.	012528
CSA Class No.	3211-03
NA Certification	UL Listed, CSA certified

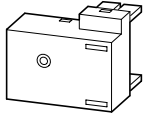
Accessories

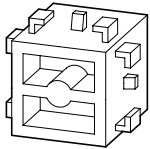
1

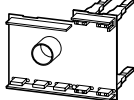
For use with	Type Article no.	Std. pack	Notes	Information relevant for export to North America	
SWD contactor modules					
SmartWire-DT module for surface-mounting on contactors. Per contactor 1 module Max. Take account of the max. current consumption of the contactor coils per SmartWire chain. A2 connections must not be bridged. Wiring sets DILM 12-XRL and PKZM0-XRM12 cannot be used Connection terminals for electrical interlocking are not suitable for safety technology.					
	DILM(C)7... - DILM(C)32 DILM38 DILA DILMP20... DILMP32... DILMP45... MSC-D(E)-... (24VDC)	DIL-SWD-32-001 118560	5 pcs.  	<ul style="list-style-type: none"> Two digital inputs for potential-free contacts 1 electrical interlock for fitting on reversing starters Messages: Switch status Contactor, status of the digital inputs 1 and 2 Commands: Contactor actuation 	Product standards IEC/EN 60947-4-1; UL 508; CSA-C22.2 No. 14-05; CE marking E29184 UL File No. NKCR UL CCN 2324643 CSA File No. 3211-07 CSA Class No. UL listed, CSA certified NA Certification
		DIL-SWD-32-002 118561	5 pcs.  	<ul style="list-style-type: none"> Two digital inputs for potential-free contacts 1 electrical interlock for fitting on reversing starters 1-0-A switch for manual or automatic operation Messages: Contactor switching position, status of the digital inputs 1 and 2, 1-0-A switch position Commands: Contactor actuation 	
Motor suppressor module					
Can be used at 380 V - 575 V, 7.5 kW, 50/60 Hz					
	DILM7 - DILM15	DILM12-XMSM 109399	4 pcs.  	<ul style="list-style-type: none"> Designed as a tool-less plug connection RC suppressor Ambient air temperature -25 - 60 °C, open Insulated material, flame retardant according to UL 94 	Product standards IEC/EN 60947-4-1; UL 508; CE marking E300273 UL File No. NMTR2 UL CCN UL-recognized NA Certification
Test cube					
Suitable for switching on contactor off-load					
	DILM7 - DILM38 DILA DILMF8 - DILMF32	DILM32-XMAN 110955	1 pc.  	-	UL/CSA certification not required
Printed board contact					
For the adaption of a control circuit on a printed-circuit board					
	DILM7 - DILM15 DILA	DILM12-XPBC 109400	4 pcs.	-	-

For use with **Type** Article no. Std. pack **Notes** **Information relevant for export to North America**

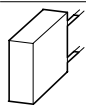

Load resistor

For DC contactors in order to increase power consumption

DILM17	DILM32-XSPLW24	10 pcs.	<ul style="list-style-type: none"> Installed in a suppressor circuit enclosure 1 necessary for actuation by special PLC outputs, e.g., Beckhoff safety contactors 	Product standards IEC/EN 60947-4-1; UL 508; CSA-C22.2 No. 14-05; CE marking UL File No. E29184 UL CCN NKCR2, NKCR8 CSA File No. 225135 CSA Class No. 3211-07 NA Certification UL listed, CSA certified
DILM25	112419			
DILM32				
DILM38				
DILMP32				
DILMP45				

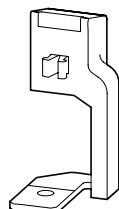

Additional terminals

DILM80	DILM150-XZK	10 pcs.	<ul style="list-style-type: none"> Can be retrofitted on every main terminal of the contactor Connection options: max. 2 x 4 mm² solid: max. 2 x 2.5 mm² flexible: with ferrules 	Product standards IEC/EN 60947-4-1; UL 508; CSA-C22.2 No. 14-05; CE marking UL File No. E29184 UL CCN NKCR CSA File No. 012528 CSA Class No. 2411-03, 2411-04 NA Certification UL listed, CSA certified
DILM95	104486			
DILM115				
DILM150				
DILM170				
DILMF80				
DILMF95				
DILMF115				
DILMF150				

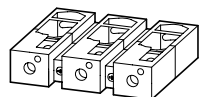

cable terminal block

With control cable connection consists of 3 flat cable terminals

DILM185A	DILM225A-XKU-S	1 pc.	For connection of: Round conductors: flexible and stranded, strip conductors	Product standards IEC/EN 60947-4-1; UL 60947-4-1; CSA-C22.2 No. 60947-4-1-14; CE marking UL File No. E29096 UL CCN NLDX CSA File No. 2389068 CSA Class No. 3211-04 NA Certification UL listed, CSA certified
DILM225A	139561			
DILM250	DILM400-XKU-S			Product standards IEC/EN 60947-4-1; UL 508; CSA-C22.2 No. 14-05; CE marking UL File No. E29184 UL CCN NKCR CSA File No. 012528 CSA Class No. 3211-04 NA Certification UL listed, CSA certified
DILM300A	208293			
DILM400				

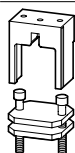

Flat strip conductor terminal kit

Set contains 3 terminals. With control circuit terminal

DILM500	DILM570-XKB-S	1 pc.	For connection of: Flat cable
	150628		
DILM580	DILM820-XKB-S		
DILM650	208295		
DILM750			
DILM820			

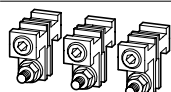

Connection terminal sets for North America

consisting of 3 individual clamps
 Conductor material: Copper, aluminium
 Cross-section X number of cores (mm²): 2x (AWG4...MCM500)

DILM500/22	DILM500-XK-CNA	1 pc.	<ul style="list-style-type: none"> Including cover With control circuit terminal 	Product standards IEC/EN 60947-4-1; UL 508; CSA-C22.2 No. 14-05; CE marking UL File No. E29184 UL CCN NKCR CSA File No. 012528 CSA Class No. 3211-04 NA Certification UL listed, CSA certified
	232192			

For use with **Type** **Std. pack** **Notes** **Information relevant for export to North America**



sealable shroud



transparent

DILM32-XTE...	DILM32-XTEPLH 101449	1 pc.	–	–
---------------	--------------------------------	-------	---	---

Covers

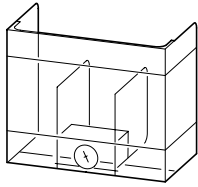

Terminal cover

DILM185A DILM225A	DILM225A-XHB 139560	1 pc. 	Busbar tag shroud for connection lugs with vertical contact from the front.	UL/CSA certification not required
DILM250 DILM300A DILM400	DILM400-XHB 208287			
DILM500	DILM500-XHB 208286			
DILM580 DILM650	DILM650-XHB 208285			
DILM750 DILM820 DILM1000	DILM820-XHB 208284			

Cover for star-point bridge

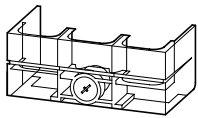

DILM400-XS1	DILM400-XHBS1 101687	1 pc. 		UL/CSA certification not required
-------------	--------------------------------	-----------	--	-----------------------------------

Contactors cover

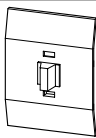

DILM7 - DILM38 DILMP32 DILMP45 DILA DILL DILMF8 - DILMF32	DILM32-XAB 129538	10 pcs. 	For preventing manual actuation. Cannot be combined with further fitting accessories.	UL/CSA certification not required
--	-----------------------------	-------------	---	-----------------------------------

Suppressor circuits for vacuum contactors (on load side)

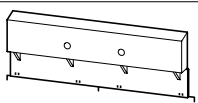

DILM580 DILM650 DILM750 DILM820 DILM1000 DILH1200 DILH1400	DILM1000-XSM 125947	1 pc. 	For damping the cutout overvoltage when switching off inductive loads.	Product standards IEC/EN 60947-4-1; UL 508; CSA-C22.2 No. 14-05; CE marking UL File No. E29096 UL CANNJ NLDX CSA File No. 165628 CSA Class No. C321104 NA Certification UL listed, CSA certified
DILM1600 DILH2000 DILH2200 DILH2600	DILH2600-XSM 125946			

Rated operational current			Actuating voltage	Actuating current	Circuit symbol	For use with	Type Article no.	Std. pack
AC-15		DC						
230 V	400 V	220 V						
I_e	I_e	I_e	U_s	I				
A	A	A	V DC	mA				

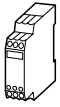

amplifier module for separate mounting

Input with built-in suppressor circuit for overvoltage limitation

2	2	0.03	24	25		DILM... DIMLP... DILL... DILK... DILMF...	ETS4-VS3 083094	1 pc.
---	---	------	----	----	--	---	---------------------------	-----------

Notes

Contactor coils with rated operational current > 2 A must be actuated via the DILER-G mini contactor relay.
Rated operational current DC:
Switch-on and switch-off conditions based on DC-13, time 300 ms

Information relevant for export to North America



Product standards	IEC/EN 60947-4-1; UL 508; CSA-C22.2 No. 14-05; CE marking
UL File No.	E29184
UL CCN	NKCR
CSA File No.	012528
CSA Class No.	2411-03, 3211-04
NA Certification	UL-listed, CSA certified

For use with	DC Voltage	Alternating voltage	Std. pack
	Type Article no.	Type Article no.	

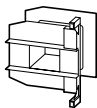

Individual coils

DILM17 – DILM38 DILMP32 – DILMP45	DILM32-XSP(RDC24) ^{1) 2)} 281155	DILM32-XSP(230V50HZ,240V60HZ) ²⁾ 281141	1 pc.
DILM40 – DILM72 DILMP63 DILMP80	DILM65-XSP(RDC24) ^{1) 2)} 281185	DILM65-XSP(230V50HZ,240V60HZ) ²⁾ 281171	
DILM80 DILM95	DILM95-XSP(RDC24) ^{1) 2)} 230080	DILM95-XSP(230V50HZ,240V60HZ) ²⁾ 230062	
DILM115 – DILM170 DILMP125 – DILMP200	DILM150-XSP(RDC24) ^{1) 2)} 230115	DILM150-XSP(RAC240) ^{1) 2)} 230112	
DILM185A DILM225A	DILM225A-XSP(RDC24) ^{1) 3)} 139568	DILM225A-XSP(RAC240) ^{1) 3)} 139565	

Notes

¹⁾ Including electronic module
Further actuating voltages → Page 1/88

Information relevant for export to North America



2)		3)	
Product standards	IEC/EN 60947-4-1; UL 508; CSA-C22.2 No. 14-05; CE marking	Product standards	IEC/EN 60947-4-1; UL 60947-4-1; CSA - C22.2 No. 60947-4-1-14; CE marking
UL File No.	E29096	UL File No.	E29096
UL CCN	NLDX	UL CCN	NLDX
CSA File No.	12528	CSA File No.	2389068
CSA Class No.	2411-03, 3211-04	CSA Class No.	3211-04
NA Certification	UL listed, CSA certified	NA Certification	UL listed, CSA certified

Accessories

1



For use with	DC Voltage Type Article no.	Alternating voltage Type Article no.	Std. pack	Notes
Electronic modules including coils				
DILM250 DILM300A	DILM250-XSP/E(RA250)¹⁾ 208252	DILM250-XSP/E(RA250)¹⁾ 208252	1 pc. 	Further actuating voltages → Page 1/90
DILM400 DILM500	DILM500-XSP/E(RA250)²⁾ 208256	DILM500-XSP/E(RA250)²⁾ 208256		
DILM580 DILM650 DILM750 DILM820 DILM1000	DILM1000-XSP/E(RA250)²⁾ 289145	DILM1000-XSP/E(RA250)²⁾ 289145		
DILH1400	DILH1400-XSP/E(RAW250)²⁾ 289161	DILH1400-XSP/E(RAW250)²⁾ 289161		
DILM250-S DILM300A-S	–	DILM250-S-XSP/E(220-240V50/60HZ)¹⁾ 274202		
DILM400-S DILM500-S	–	DILM500-S-XSP/E(220-240V50/60HZ)²⁾ 274205		

Notes

Information relevant for export to North America



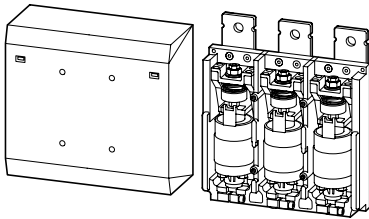

Product standards	IEC/EN 60947-4-1; UL 508; CSA-C22.2 No. 14-05; CE marking
UL File No.	E29096
UL CCN	NLDX
CSA File No.	¹⁾ 1017510 ²⁾ 012528
CSA Class No.	3211-04
NA Certification	UL Listed, CSA certified

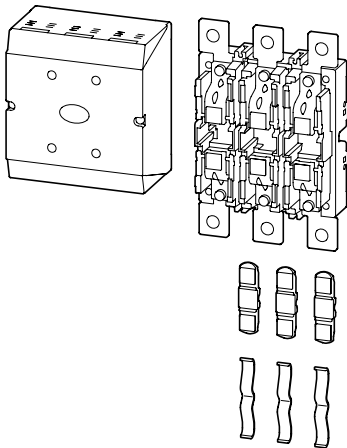

For use with	Type Article no.	Std. pack	Information relevant for export to North America 	
Vacuum interrupter sets				
DILM580	DILM580-XCT 208299	1 pc. 	Product standards	IEC/EN 60947-4-1; UL 60947-4-1; CSA-C22.2 No. 60947-4-1-14; CE marking
DILM650	DILM650-XCT 208300		UL File No.	E29096
DILM750	DILM750-XCT 208301		UL CCN	NLDX
DILM820	DILM820-XCT 208302		CSA File No.	012528
DILH1400	DILH1400-XCT 168599		CSA Class No.	3211-04
			NA Certification	UL listed, CSA certified



For use with	Type Article no.	Std. pack	Information relevant for export to North America 	
Contact fingers (set), 3-pole				
DILM225A	DILM225A-XCT¹⁾ 153398	1 pc. 	Product standards	IEC/EN 60947-4-1; UL 60947-4-1; CSA-C22.2 No. 60947-4-1-14; CE marking
DILM250	DILM250-XOCT²⁾ 168812		UL File No.	E29096
DILM300A	DILM300A-XOCT²⁾ 168811		UL CCN	NLDX
DILM400	DILM400-XOCT³⁾ 168810		CSA File No.	¹⁾ 2389068 ²⁾ 1017510 ³⁾ 012528
DILM500	DILM500-XOCT³⁾ 168809		CSA Class No.	3211-04
			NA Certification	UL listed, CSA certified

For use with **Type** Std. pack **Information relevant for export to North America**
 Article no.  

Reversing bridges

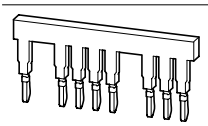

DILM7 – DILM12 DILMP20	DILM12-XRA2 239372	1 pc.  	Product standards UL File No. UL CCN CSA File No. CSA Class No.	IEC/EN 60947-4-1; UL 508; CSA-C22.2 No. 14-05; CE marking E36332 NLRV 012528 3211-04 ¹⁾ 2411-03, 3211-04
DILM7 – DILM12 Without A2 bridge, for SmartWire-DT	DILM12-XR 110099			

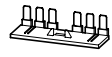

DILM17 – DILM32	DILM32-XR 239373		NA Certification	¹⁾ 2411-03, 3211-04 UL listed, CSA certified
-----------------	----------------------------	--	------------------	--





DILM40 – DILM65	DILM65-XR 101060			
-----------------	----------------------------	--	--	--

DILM80 DILM95 DILM115 DILM150	DILM150-XR¹⁾ 101686			
--	--	--	--	--

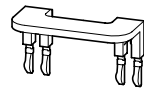
Link





Electrical interlock

DILM7 – DILM12	DILM12-XEV 239374	1 pc.  	Product standards UL File No. UL CCN CSA File No. CSA Class No. NA Certification	IEC/EN 60947-4-1; UL 60947-4-1; CSA-C22.2 No. 60947-4-1-14; CE marking E36332 NLRV 012528 3211-05 UL listed, CSA certified
----------------	-----------------------------	--	---	--

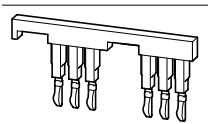
Parallel bridges



DILM7 – DILM15 DILMP20	DILM12-XP2²⁾ 239370	1 pc.  	Product standards UL File No. UL CCN CSA File No. CSA Class No.	IEC/EN 60947-4-1; UL 60947-4-1; CSA-C22.2 No. 60947-4-1-14; CE marking E36332 NLRV 012528 3211-04
---------------------------	--	--	---	--

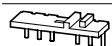

DILM17 – DILM32	DILM32-XP2 239371			²⁾ 3211-5 ³⁾ 2411-03, 3211-04
-----------------	-----------------------------	--	--	--



DILM40 – DILM65	DILM65-XP2 101059		NA Certification	UL listed, CSA certified
-----------------	-----------------------------	--	------------------	--------------------------

DILM80 – DILM150	DILM150-XP2³⁾ 101685			
------------------	---	--	--	--

1



General

For safety-oriented shutdown of safety categories 3 and 4 in accordance with EN 954-1 or EN ISO 13849 performance levels d and e, now two contactors in a row must be used. Especially with larger contactors this is an expensive solution.

Usage

This is where the CMD can be used. The function of the CMD is to monitor the main contacts of a contactor against welding. For this, the control voltage of the contactor is compared with the state of the main contacts which is reliably monitored using a mirror contact (IEC EN 60947-4-1 appendix F). If the contactor coil is de-energized and the contactor does not drop out, the CMD trips the upstream circuit breaker/motor-protective circuit breaker/switch-disconnector via an undervoltage release.

Safety

The CMD is of a safety-oriented design, so that in safety-oriented applications in combination with a circuit breaker/motor-protective circuit breaker/switch-disconnector, the reliable switch off in the case of a "welded contactor" can be guaranteed. In these applications, it replaces the series connection of a second contactor. As a component, it conforms to safety category 3 according to EN 954-1 and EN ISO 13849.

Assembly

The CMD can be combined with the following Eaton components:

Contactor:

- DILM(C)7, DILM(C)9, DILM(C)12, DILM(C)15, DILM(C)17, DILM(C)25, DILM(C)32, DILM(C)40, DILM(C)50, DILM(C)65, DILM(C)72, DILM(C)80, DILM(C)95, DILM(C)115, DILM(C)150, DILM(C)170
- DILEEM and DILEM
- DILM185A, DILM225A, DILM250(-S), DILM300A(-S), DILM400(-S), DILM500(-S)
- DILM580, DILM650, DILM750, DILM820, DILM1000
- DILH1400, DILH2000

For the wiring of the CMD, the auxiliary NC must have a mirror contact function in accordance with IEC/EN 60947-4-1, and the auxiliary NO must also be interlocked opposing in accordance with IEC/EN 60947-5-1. In addition, the auxiliary NC must likewise have a mirror contact function in accordance with IEC/EN 60947-4-1 for the feedback circuit.

Motor-protective circuit breaker/ circuit breaker:

- NZM1, N1 + NZM1-XU(HIV) (L)18DC
- NZM2, N2 + NZM2/3-XU(HIV20)18DC
- NZM3, N3 + NZM2/3-XU(HIV20)18DC
- NZM4, N4 + NZM4-XU(HIV20)18DC

Auxiliary contact requirements per contactor:

	CMD	Self maintaining	Feedback circuit	Electrical interlock
Direct starter	1 M + 1 B	1 N/O	1 N/C	–
Reversing starter	1 M + 1 B	1 N/O	1 N/C	1 N/C

Product Selection

Type	Std. pack	Information relevant for export to North America	
Article no.		USA	Canada
Contactormonitoring device CMD			
CMD(24VDC) 106170	1 pc. 		
CMD(220-240VAC) 106172	1 pc. 		
		Product standards CSA File No CSA Class No. NA Certification	IEC/EN 60947-4-1; CSA-C22.2 No. 14-10; ANSI/UL 508; CE marking 012528 3211-04, 3211-84 (Certified to US Standards) CSA certified

Engineering

Direct starter

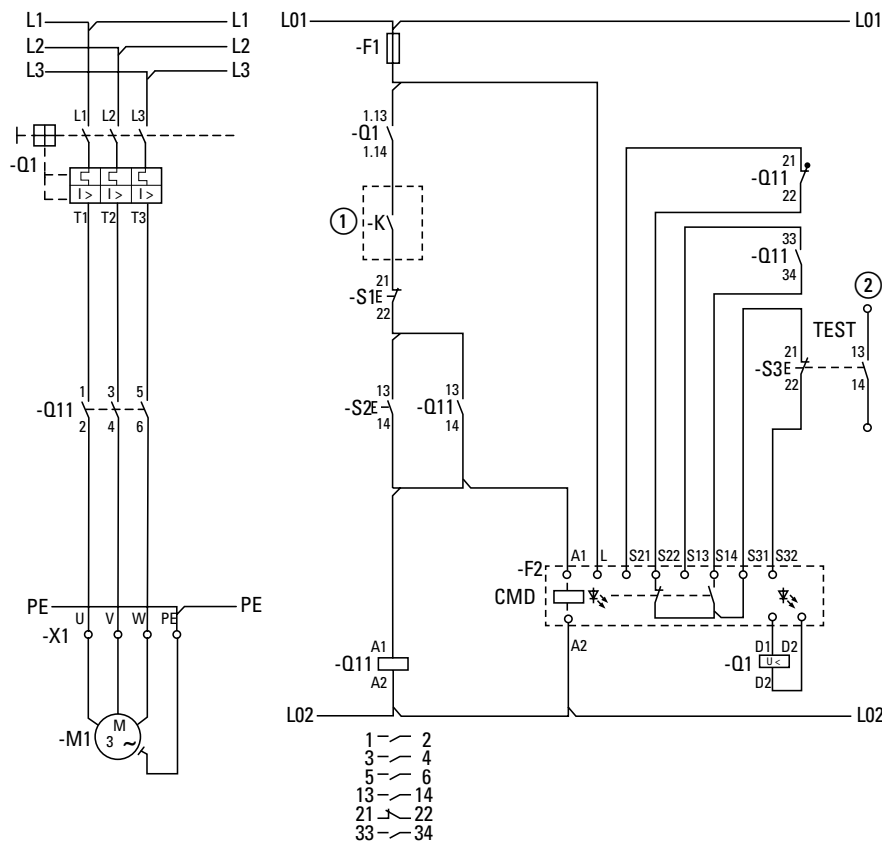

Reversing starter

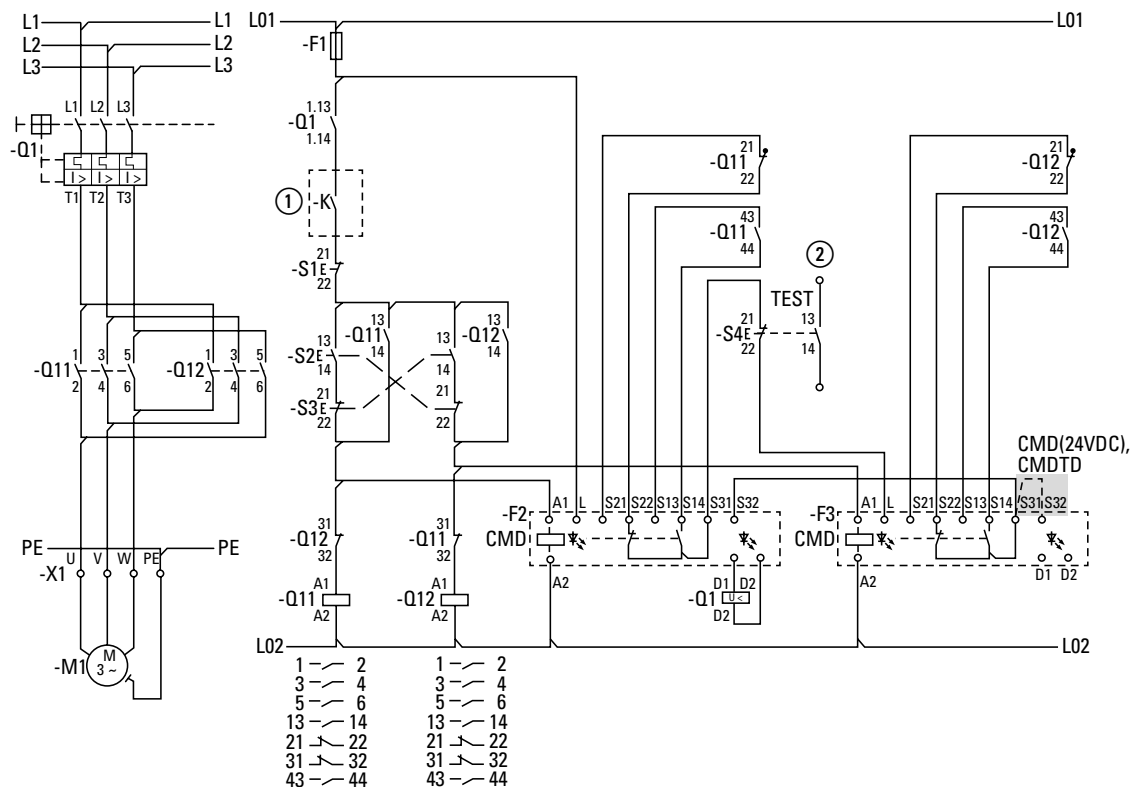

- ① Switching by safety relay of safety PLC
- ② Signaling contact to PLC evaluation
- ③ CMD (24VDC)

Product Selection

	DILER-40(...)	DILER-40-C(...)	DILER-31(...)	DILER-31-C(...)	DILER-22(...)	DILER-22-C(...)	DILEEM-10(...)	DILEEM-10-C(...)	DILEEM-01(...)
	Article no.	Article no.	Article no.	Article no.	Article no.	Article no.	Article no.	Article no.	Article no.
Standard voltages									
AC	24V50HZ	010094	231834	010251	231811	010344	231786	051604	051629
	48V50HZ	010190	231835	010044	231812	010201	231787	051603	051628
	70V50HZ								257053
	220-240V50HZ					025410			
	240V50HZ	010478	231836	010300	231813	010138	231788	051602	051627
	24V60HZ	010110		010267		010497		051600	
	110V60HZ					010265		051599	
	115V60HZ	010270	231839	010204	231816	010211	231791	051598	
	208V60HZ	158182		158176		158170		158150	158144
	380V60HZ	158184		158178		158172		158152	158146
	600V60HZ	010207		010093		010314			
	42V50HZ, 48V60HZ	051755	231840	051764	231817	051773	231792	051612	051637
	110V50HZ, 120V60HZ	051756	231841	051765	231818	051774	231793	051611	051636
	190V50HZ, 220V60HZ	051757	231842	051766	231819	051775	231794	051610	051635
	220V50HZ, 240V60HZ	051758	231843	051767	231820	051776	231795	051609	051634
	240V50HZ, 277V60HZ	158183		158177		158171		158151	158145
	380V50HZ, 440V60HZ	051760	231844	051769	231821	051778	231796	051607	051632
	400V50HZ, 440V60HZ	051761		051770		051779		051606	051631
	415V50HZ, 480V60HZ	051762	231846	051771	231823	051780	231798	051605	051630
	550V50HZ, 600V60HZ	158185		158179		158173		158153	158147
	12V50/60HZ	158181		158175		158169		158149	158143
	24V50/60HZ	021924	231847	021594	231824	021704	231799	051596	051621
	42V50/60HZ	033459	231848	029869	231825	029433	231800	051595	051620
	110V50/60HZ	021961		021624		021871		051592	051618
	220V50/60HZ	021983		021665		021889		051591	051616
	230V50/60HZ	052725		052509		052508		056674	230049
	TVC100 ¹⁾	000644				000648			058771
	TVC200 ²⁾	000643		000645		000647			
	DILER-40-G(...)	DILER-40-G-C(...)	DILER-31-G(...)	DILER-31-G-C(...)	DILER-22-G(...)	DILER-22-G-C(...)	DILEEM-10-G(...)	DILEEM-01-G(...)	
	Article no.	Article no.	Article no.	Article no.	Article no.	Article no.	Article no.	Article no.	

Standard voltages									
DC	12VDC	079711		079761		080728		051644	051649
	48VDC	010255		010205		010346		051642	051648
	60VDC	010271				010499		051641	051647
	110VDC	010287	231854	010253	231831	010043	231806	051640	051646
	120VDC	158186		158180		158174		158154	158148
	125VDC			292895				292892	
	220VDC	010303	231855	010269	231832	010091	231807	051639	051645

Notes

To obtain the article number for ordering, read under selected part number and actuating voltage from the table.

Devices with dual-voltage coils must be ordered under a single article no.

¹⁾ TVC100 = 100 V, 50Hz / 100 - 110 V, 60 Hz; voltage tolerance: $(0.85 - 1.1) \times U_c$

²⁾ TVC200 = 200 V, 50Hz / 200 - 220 V, 60 Hz; voltage tolerance: $(0.85 - 1.1) \times U_c$

		DILEM-10(...)	DILEM-10-C(...)	DILEM-01(...)	DILEM-01-C(...)	DILEM12-10(...)	DILEM12-01(...)	DILEM4(...)
		Article no.	Article no.	Article no.	Article no.	Article no.	Article no.	Article no.
Standard voltages								
AC	24V50HZ	010005	231651	010086	231674	127067	127083	014754
	48V50HZ	010020	231652	010294	231675			011052
	240V50HZ	010032	231653	010151	231676			014305
	24V60HZ	010006		010134				014776
	115V60HZ	010024	231656	010470	231679			
	208V60HZ	210256		227914				158165
	380V60HZ	158162		158157				158167
	600V60HZ	010197		010327				
	42V50HZ,48V60HZ	051782	231657	051791	231680			051800
	110V50HZ,120V60HZ	051783	231658	051792	231681	127072	127088	051801
	190V50HZ,220V60HZ	051784	231659	051793	231682			051802
	220V50HZ,240V60HZ	051785	231660	051794	231683	127074		051803
	240V50HZ,277V60HZ	158161		158156				158166
	380V50HZ,440V60HZ	051787	231661	051796	231684	127076		051805
	400V50HZ,440V60HZ	051788		051797				051806
	415V50HZ,480V60HZ	051789	231663	051798	231686			051807
	550V50HZ,600V60HZ	158163		158158				
	12V50/60HZ	158160		158155				
	24V50/60HZ	021417	231664	020402	231687	127079	127095	022044
	42V50/60HZ	032174	231665	033233	231688			
	110V50/60HZ	021455		020436				
	220V50/60HZ	021520		021380				022078
	230V50/60HZ	052302	231667	051114	231690	127082	127098	052506
	380V50/60HZ	032241		033348				
	TVC100 ¹⁾	000642		000640				000638
	TVC200 ²⁾	000641		000639				000637
		DILEM-10-G(...)	DILEM-10-G-C(...)	DILEM-01-G(...)	DILEM-01-G-C(...)			DILEM4-G(...)
		Article no.	Article no.	Article no.	Article no.			Article no.
Standard voltages								
DC	12VDC	079594		079642				079680
	48VDC	010245		010496				012811
	110VDC	010309	231671	010136	231694			013166
	120VDC	158164		158159				158168
	125VDC			182885				
	220VDC	010325	231672	010168	231695			013194
	250VDC			180641				

Notes

To obtain the article number for ordering, read under selected part number and actuating voltage from the table.

Devices with dual-voltage coils must be ordered under a single article no.

¹⁾ TVC100 = 100 V, 50Hz / 100 - 110 V, 60 Hz; voltage tolerance: (0.85 - 1.1) x U_c

²⁾ TVC200 = 200 V, 50Hz / 200 - 220 V, 60 Hz; voltage tolerance: (0.85 - 1.1) x U_c

DILA actuating voltages

1

		With screw terminals			with spring-loaded terminals		
		DILA-22(...)	DILA-31(...)	DILA-40(...)	DILAC-22(...)	DILAC-31(...)	DILAC-40(...)
		Article no.	Article no.	Article no.	Article no.	Article no.	Article no.
Standard voltages							
AC	24V50HZ	276386	276351	276316	276495	276463	276431
	48V50HZ	276387	276352	276317	276496	276464	276432
	240V50HZ	276388	276353	276318			
	24V60HZ	276390	276355	276320			
	115V60HZ	276392	276357	276322			
	208V60HZ	276393	276358	276323			
	380V60HZ	158130	158136	158141			
	600V60HZ	276394	276359	276324			
	42V50HZ,48V60HZ	276395	276360	276325			
	110V50HZ,120V60HZ	276396	276361	276326	276502	276470	276438
	190V50HZ,220V60HZ	276397	276362	276327			
	220V50HZ,240V60HZ	276398	276363	276328			
	240V50HZ,277V60HZ	158129	158135	158140			
	380V50HZ,440V60HZ	276400	276365	276330			
	400V50HZ,440V60HZ	276401	276366	276331			
	415V50HZ,480V60HZ	276402	276367	276332			
	550V50HZ,600V60HZ	158131	158137	158142			
	12V50/60HZ	158128	158134	158139			
	24V50/60HZ	276403	276368	276333	276509	276477	276445
	42V50/60HZ	276404	276369	276334			
	110V50/60HZ	276405	276370	276335			
	220V50/60HZ	276406	276371	276336			
	230V50/60HZ	276407	276372	276337	276513	276481	276449
380V50/60HZ	276408	276373	276338				
TVC100 ²⁾	276409	276374	276339				
TVC200 ³⁾	276410	276375	276340				
DC	12VDC	276413	276378	276343			
	48VDC	276415	276380	276345			
	60VDC	276416	276381	276346			
	110VDC	276417	276382	276347	276523	276491	276459
	120VDC	158127	158133	158138			
	220VDC	276418	276383	276348	276524	276492	276460
Non-standard voltages with the exception of the given standard voltages¹⁾							
AC	*V50HZ(12 - 500V)	276411	276376	276341	276517	276485	276453
	*V60HZ(12 - 600V)	276412	276377	276342	276518	276486	276454
DC	*VDC(12 - 250V)	276419	276384	276349	276525	276493	276461

Notes

To obtain the article number for ordering, read under selected part number and actuating voltage from the table.

Devices with dual-voltage coils must be ordered under a single article no.

¹⁾ * = required actuating voltage from the specified range(...-...V); minimum order quantity 10 pcs.

²⁾ TVC100 = 100 V, 50Hz / 100 - 110 V, 60 Hz; voltage tolerance: (0.85 - 1.1) x U_c

³⁾ TVC200 = 200 V, 50Hz / 200 - 220 V, 60 Hz; voltage tolerance: (0.85 - 1.1) x U_c

DILM7 – DILM15 actuating voltages

		DILM7-10(...)	DILM7-01(...)	DILM9-10(...)	DILM9-01(...)	DILM12-10(...)	DILM12-01(...)	DILM15-10(...)	DILM15-01(...)	
		Article no.	Article no.	Article no.	Article no.	Article no.	Article no.	Article no.	Article no.	
Standard voltages										
AC	24V50HZ	276537	276572	276677	276712	276817	276852	290045	290080	
	48V50HZ	276538	276573	276678	276713	276818	276853	290046	290081	
	240V50HZ	276539	276574	276679	276714	276819	276854	290047	290082	
	24V60HZ	276541	276576	276681	276716	276821	276856	290049	290084	
	115V60HZ	276543	276578	276683		276823	276858			
	208V60HZ	276544	276579	276684	276719	276824	276859	290052	290087	
	380V60HZ							158203	158198	
	600V60HZ	276545	276580	276685	276720	276825	276860	290053	290088	
	42V50HZ,48V60HZ	276546	276581	276686	276721	276826	276861	290054	290089	
	110V50HZ,120V60HZ	276547	276582	276687	276722	276827	276862	290055	290090	
	190V50HZ,220V60HZ	276548	276583	276688	276723	276828	276863	290056	290091	
	220V50HZ,240V60HZ	276549	276584	276689	276724	276829	276864	290057	290092	
	240V50HZ,277V60HZ	158220	158216	158228	158224	158193	158189	158202	158197	
	380V50HZ,440V60HZ	276551	276586	276691	276726	276831	276866	290059	290094	
	400V50HZ,440V60HZ	276552	276587	276692	276727	276832	276867	290060	290095	
	415V50HZ,480V60HZ	276553	276588	276693	276728	276833	276868	290061	290096	
	550V50HZ,600V60HZ	158221	158217	158229	158225	158194	158190	158204	158199	
	12V50/60HZ	158219	158215	158227	158223	158192	158188	158201	158196	
	24V50/60HZ	276554	276589	276694	276729	276834	276869	290062	290097	
	42V50/60HZ	276555	276590	276695	276730	276835	276870			
	110V50/60HZ	276556	276591	276696	276731	276836	276871	290064	290099	
	220V50/60HZ	276557	276592	276697	276732	276837	276872	290065	290100	
	230V50/60HZ	276558	276593	276698	276733	276838	276873	290066	290101	
	380V50/60HZ	276559	276594	276699	276734	276839	276874	290067	290102	
	TVC100 ²⁾	276560	276595	276700	276735	276840	276875	290068	290103	
	TVC200 ³⁾	276561	276596	276701	276736	276841	276876	290069	290104	
	DC	12VDC	276564	276599	276704		276844	276879	290072	290107
		48VDC	276566	276601	276706	276741	276846	276881	290074	290109
		60VDC			276707					
		110VDC	276568	276603	276708	276743	276848	276883		
120VDC		158218	158214	158226	158222	158191	158187	158200	158195	
220VDC		276569	276604	276709	276744	276849	276884	290077	290112	
Non-standard voltages with the exception of the given standard voltages¹⁾										
AC	*V50HZ(12 - 600V)	276562	276597	276702	276737	276842	276877	290070	290105	
	*V60HZ(12 - 600V)	276563	276598	276703	276738	276843	276878	290071	290106	
DC	*VDC(12 - 250V)	276570	276605	276710	276745	276850	276885	290078	290113	

Notes

To obtain the article number for ordering, read under selected part number and actuating voltage from the table.

Devices with dual-voltage coils must be ordered under a single article no.

¹⁾ * = required actuating voltage from the specified range (...-...V); minimum order quantity 10 pcs.

²⁾ TVC100 = 100 V, 50Hz / 100 - 110 V, 60 Hz; voltage tolerance: (0.85 - 1.1) x U_c

³⁾ TVC200 = 200 V, 50Hz / 200 - 220 V, 60 Hz; voltage tolerance: (0.85 - 1.1) x U_c

	DILM17-10(...)	DILM17-01(...)	DILM25-10(...)	DILM25-01(...)	DILM32-10(...)	DILM32-01(...)	DILM38-10(...)	DILM38-01(...)
	Article no.	Article no.	Article no.	Article no.	Article no.	Article no.	Article no.	Article no.
Standard voltages								
AC	24V50HZ	276991	277023	277119	277151	277247	277279	112378 112446
	48V50HZ	276992	277024	277120	277152	277248	277280	
	240V50HZ	276993	277025	277121	277153	277249	277281	112420
	24V60HZ	276995	277027	277123	277155	277251	277283	
	115V60HZ	276997	277029	277125	277157	277253	277285	
	208V60HZ	276998	277030	277126	277158	277254	277286	
	600V60HZ	276999	277031	277127	277159	277255	277287	
	42V50HZ,48V60HZ	277000	277032	277128	277160	277256	277288	112424
	110V50HZ,120V60HZ	277001	277033	277129	277161	277257	277289	112425 112453
	190V50HZ,220V60HZ	277002		277130		277258		112426
	220V50HZ,240V60HZ	277003	277035	277131	277163	277259	277291	112427
	380V50HZ,440V60HZ	277005		277133		277261		112429
	400V50HZ,440V60HZ	277006	277038	277134	277166	277262	277294	112430 112458
	415V50HZ,480V60HZ	277007	277039	277135	277167	277263	277295	112431
	24V50/60HZ	277008	277040	277136	277168	277264	277296	112432 112460
	42V50/60HZ	277009		277137		277265		112433
	110V50/60HZ	277010	277042	277138	277170	277266	277298	112434 112462
	220V50/60HZ	277011	277043	277139	277171	277267	277299	112435 112463
	230V50/60HZ	277012	277044	277140	277172	277268	277300	112436 112464
	380V50/60HZ	277013	277045	277141	277173	277269	277301	
	TVC100 ³⁾	277014	277046	277142	277174	277270	277302	112438 112466
	TVC200 ⁴⁾	277015	277047	277143	277175	277271	277303	112439 112467
DC	RDC12			104812	104811			
	RDC60	277019	277051	277147	277179	277275	277307	112443 112471
	RDC130	277020	277052	277148	277180	277276	277308	112444 112472
	RDC240	277021	277053	277149	277181	277277	277309	112445 112473
Non-standard voltages with the exception of the given standard voltages¹⁾								
AC	*V50HZ(24 - 600V)	277016	277048	277144	277176	277272 ²⁾	277304 ²⁾	112440 112468
	*V60HZ(24 - 600V)	277017	277049	277145	277177	277273 ²⁾	277305 ²⁾	112441 112469

Notes

To obtain the article number for ordering, read under selected part number and actuating voltage from the table.

Devices with dual-voltage coils must be ordered under a single article no.

¹⁾ * = required actuating voltage from the specified range (...-...V); minimum order quantity 10 pcs.

²⁾ minimum order quantity 5 pcs.

RDC12 12 - 14 V DC

RDC24 24 - 27 V DC

RDC60 48 - 60 V DC

RDC130 110 - 130 V DC

RDC240 200 - 240 V DC

³⁾ TVC100 = 100 V, 50Hz / 100 - 110 V, 60 Hz; voltage tolerance: $(0.85 - 1.1) \times U_c$

⁴⁾ TVC200 = 200 V, 50Hz / 200 - 220 V, 60 Hz; voltage tolerance: $(0.85 - 1.1) \times U_c$

DILM40 – DILM225A actuating voltages

	DILM40(...)	DILM50(...)	DILM65(...)	DILM72(...)	DILM80(...)	DILM95(...)	
	Article no.	Article no.	Article no.	Article no.	Article no.	Article no.	
Standard voltages							
AC	24V50HZ	277753	277817	277881		235904	
	48V50HZ	277754	277818	277882		235909	
	240V50HZ	277755	277819	277883	109183	235910	
	500V50HZ			277884			
	24V60HZ	277757	277821	277885		239377	
	115V60HZ	277759	277823	277887		239379	
	208V60HZ	277760	277824	277888		239384	
	600V60HZ	277761	277825	277889		239389	
	42V50HZ,48V60HZ	277762	277826	277890		239394	
	110V50HZ,120V60HZ	277763	277827	277891	109191	239399	
	190V50HZ,220V60HZ	277764	277828	277892		239400	
	220V50HZ,240V60HZ	277765	277829	277893	109193	239401	
	380V50HZ,440V60HZ	277767	277831	277895		239403	
	400V50HZ,440V60HZ	277768	277832	277896	109195	239404	
	415V50HZ,480V60HZ	277769	277833	277897		239405	
	550V50HZ,600V60HZ						
	24V50/60HZ	277770	277834	277898	109197	239406	
	42V50/60HZ	277771	277835	277899		239407	
	110V50/60HZ	277772	277836	277900	109199	239408	
	220V50/60HZ	277773	277837	277901	109200	239409	
	230V50/60HZ	277774	277838	277902	109201	239410	
	380V50/60HZ	277775	277839	277903		239411	
	TVC100 ⁴⁾	277776	277840	277904		239412	
	TVC200 ⁵⁾	277777	277841	277905		239413	
	DC	RDC60	277781	277845	277909		239417
		RDC130	277782	277846	277910	109208	239418
		RDC240	277783	277847	277911	109209	239419
Non-standard voltages with the exception of the given standard voltages¹⁾							
AC	*V50HZ(24 - 600V)	277778 ²⁾	277842 ²⁾	277906 ²⁾	109205 ³⁾	239414 ²⁾	
	*V60HZ(24 - 600V)	277779 ²⁾	277843 ²⁾	277907 ²⁾	109206 ³⁾	239415 ²⁾	
	DILM115...	DILM150...	DILM170...	DILM185A/22(...)	DILM225A/22(...)		
	Article no.	Article no.	Article no.	Article no.	Article no.		
AC	RAC24	239545	239585	107010	139534	139544	
	RAC48	239546	239586	107011	139535	139545	
	RAC120	239547	239587	107012	139536	139546	
	RAC440	239549	239589	107014	139538	139548	
	RAC500	239550	239590	107015	139539	139549	
DC	RDC24	→ Page 1/27	→ Page 1/27	→ Page 1/27	139540	139550	
	RDC60	239560	239592	107017	139541	139551	
	RDC130	239567	239593	107018	139542	139552	
	RDC240	239572	239594	107019	139543	139553	

Notes

To obtain the article number for ordering, read under selected part number and actuating voltage from the table.

Devices with dual-voltage coils must be ordered under a single article no.

¹⁾ * = required actuating voltage from the specified range (...-...V).

²⁾ minimum order quantity 5 pcs.

³⁾ minimum order quantity 10 pcs.

RDC24 24 - 27 V DC

RDC60 48 - 60 V DC

RDC130 110 - 130 V DC

RDC240 200 - 240 V DC

RAC24 24 V 50/60 Hz

RAC48 42 - 48 V 50/60 Hz

RAC120 100 - 120 V 50/60 Hz

RAC240 190 - 240 V 50/60 Hz

RAC440 380 - 440 V 50/60 Hz

RAC500 480 - 500 V 50/60 Hz

⁴⁾ TVC100 = 100 V, 50Hz / 100 - 110 V, 60 Hz; voltage tolerance: (0.85 - 1.1) x U_c

⁵⁾ TVC200 = 200 V, 50Hz / 200 - 220 V, 60 Hz; voltage tolerance: (0.85 - 1.1) x U_c

DILMC7 – DILMC95 actuating voltages

1

		DILMC7-10(...)	DILMC7-01(...)	DILMC9-10(...)	DILMC9-01(...)	DILMC12-10(...)	DILMC12-01(...)	DILMC15-10(...)	DILMC15-01(...)
		Article no.	Article no.	Article no.	Article no.	Article no.	Article no.	Article no.	Article no.
Standard voltages									
AC	24V50HZ	277379	277411	277443	277475	277507	277539	293638	293933
	48V50HZ	277380	277412	277444	277476	277508	277540		
	115V60HZ						277544		
	110V50HZ, 120V60HZ	277386	277418	277450	277482	277514	277546	293908	293943
	400V50HZ, 440V60HZ			277455					
	24V50/60HZ	277393	277425	277457	277489	277521	277553	293915	293950
	230V50/60HZ	277397	277429	277461	277493	277525	277557	293919	293954
DC	110VDC	277407	277439	277471	277503	277535	277567		
	220VDC	277408	277440	277472	277504	277536	277568		293965

Non-standard voltages with the exception of the given standard voltages¹⁾

AC	*V50HZ(12 - 600V)	277401	277433	277465	277497	277529	277561	293923	293958
	*V60HZ(12 - 600V)	277402	277434	277466	277498	277530	277562	293924	293959
DC	*VDC(12 - 250V)	277409	277441	277473	277505	277537	277569	293931	293966

	DILMC17-10(...)	DILMC17-01(...)	DILMC25-10(...)	DILMC25-01(...)	DILMC32-10(...)	DILMC32-01(...)
	Article no.	Article no.	Article no.	Article no.	Article no.	Article no.

Standard voltages							
AC	24V50HZ	277570	277600	277630	277660	277690	277720
	48V50HZ	277571	277601	277631	277661	277691	277721
	115V60HZ	277576			277666		
	110V50HZ, 120V60HZ	277578	277608	277638	277668	277698	277728
	24V50/60HZ	277585	277615	277645	277675	277705	277735
	220V50/60HZ	277588	277618	277648	277678	277708	277738
	230V50/60HZ	277589	277619	277649	277679	277709	277739
DC	RDC130	277597	277627	277657	277687	277717	277747
	RDC240	277598	277628	277658	277688	277718	277748

Non-standard voltages with the exception of the given standard voltages¹⁾

AC	*V50HZ(24 - 600V)	277593	277623	277653	277683	277713	277743
	*V60HZ(24 - 600V)	277594	277624	277654	277684	277714	277744

	DILMC40(...)	DILMC50(...)	DILMC65(...)	DILMC80(...)	DILMC95(...)	
	Article no.	Article no.	Article no.	Article no.	Article no.	
AC	48V50HZ	277955	277985	278015	239606	239657
	115V60HZ	277960		278020		
	110V50HZ, 120V60HZ	277962	277992	278022		
	24V50/60HZ	277969				
	230V50/60HZ	277973	278003	278033		

Notes To obtain the article number for ordering, read under selected part number and actuating voltage from the table.
 Devices with dual-voltage coils must be ordered under a single article no.
¹⁾ * = required actuating voltage from the specified range (...-...V); minimum order quantity 10 pcs.
 RDC130 110 - 130 V DC
 RDC240 200 - 240 V DC

	DILMP 20(...)	DILMP 32-10(...)	DILMP 32-01(...)	DILMP 45-10(...)	DILMP 45-01(...)	DILMP 63(...)	DILMP 80(...)	DILMP 125(...)	DILMP 160(...)	DILMP 200(...)
	Article no.	Article no.	Article no.	Article no.	Article no.	Article no.	Article no.	Article no.	Article no.	Article no.
Standard voltages										
AC	24V50HZ	276957								
	48V50HZ	276958								
	240V50HZ	276959	109798	109827		109856	109885			
	24V60HZ	276961								
	208V60HZ	276964								
	380V60HZ	158238								
	600V60HZ	276965								
	42V50HZ, 48V60HZ	276966								
	110V50HZ, 120V60HZ	276967	109790	118912	109819	118915	109848	109877		
	190V50HZ, 220V60HZ	276968								
	220V50HZ, 240V60HZ	276969	109795	109824		109853	109882			
	240V50HZ, 277V60HZ	158237								
	380V50HZ, 440V60HZ	276971								
	400V50HZ, 440V60HZ	276972								
	415V50HZ, 480V60HZ	276973								
	550V50HZ, 600V60HZ	158239								
	12V50/60HZ	158236								
	24V50/60HZ	276974	109799	109828		109857	109886			
	220V50/60HZ	276977								
	230V50/60HZ	276978	109796	109825		109854	109883			
	380V50/60HZ	276979								
	TVC100 ²⁾	276980								
	TVC200 ³⁾	276981								
	RAC24							109904	109914	109924
	RAC120							109903	109913	109923
	RAC240					167512	167513			
DC	12VDC	276984								
	48VDC	276986								
	120VDC	158235								
	220VDC	276989								
	RDC24			118916						
	RDC60		109813				109900			
	RDC130		109810							
	RDC240		109812							
Non-standard voltages with the exception of the given standard voltages¹⁾										
AC	*V50HZ(12 - 600V)	276982	109787	109816		109845	109874			
	*V60HZ(12 - 600V)	276983	109788	109817		109846	109875			
DC	*VDC(12 - 250V)	276990								

Notes

To obtain the article number for ordering, read under selected part number and actuating voltage from the table.

Devices with dual-voltage coils must be ordered under a single article no.

¹⁾ * = required actuating voltage from the specified range (...-...V); minimum order quantity 10 pcs.

- RAC24 24 V 50/60 Hz
- RAC120 100 - 120 V 50/60 Hz
- RAC240 190 - 240 V 50/60 Hz
- RDC24 24 - 27 V DC
- RDC60 48 - 60 V DC
- RDC130 110 - 130 V DC
- RDC240 200 - 240 V DC

²⁾ TVC100 = 100 V, 50Hz / 100 - 110 V, 60 Hz; voltage tolerance: (0.85 - 1.1) x U_c

³⁾ TVC200 = 200 V, 50Hz / 200 - 220 V, 60 Hz; voltage tolerance: (0.85 - 1.1) x U_c

	DILM32-XSP(...)	DILM65-XSP(...)	DILM95-XSP(...)	DILM150-XSP(...)	DILM225A-XSP(...)
	Article no.	Article no.	Article no.	Article no.	Article no.
Standard voltages					
AC	24V50HZ	281130	281160	229984	
	48V50HZ	281131	281161	229985	
	240V50HZ	281132	281162	229986	
	24V60HZ	281134	281164	229988	
	115V60HZ	281136	281166	229990	
	208V60HZ	283377	283379	229991	
	380V60HZ	158207		158233	
	600V60HZ	283378	283380	229993	
	42V50HZ,48V60HZ	281137	281167	229994	
	110V50HZ,120V60HZ	281138	281168	230058	
	190V50HZ,220V60HZ	281139	281169	230059	
	220V50HZ,240V60HZ	281140	281170	230061	
	240V50HZ,277V60HZ	158206	158211	158232	
	380V50HZ,440V60HZ	281142	281172	230063	
	400V50HZ,440V60HZ	281143	281173	230064	
	415V50HZ,480V60HZ	281144	281174	230065	
	550V50HZ,600V60HZ	158208	158212	158234	
	12V50/60HZ	158205	158210	158231	
	24V50/60HZ	281145	281175	230066	
	42V50/60HZ	281146	281176	230067	
	110V50/60HZ	281147	281177	230068	
	220V50/60HZ	281148	281178	230073	
	230V50/60HZ	281149	281179	230074	
	380V50/60HZ	281150	281180	230075	
	TVC100 ⁴⁾	281151	281181	230076	
	TVC200 ⁵⁾	281152	281182	230077	
	RAC24			230109	139562
	RAC48			230110	139563
	RAC120			230111	139564
	RAC440			230113	139566
	RAC500			230114	139567
DC	RDC12	158209	158213		
	RDC60	281156	281186	230081	139569
	RDC130	281157	281187	230082	139570
	RDC240	281158	281188	230107	139571
Non-standard voltages with the exception of the given standard voltages¹⁾					
AC	*V50HZ(24 - 600V)	281153 ²⁾	281183 ³⁾	230078 ³⁾	
	*V60HZ(24 - 600V)	281154 ²⁾	281184 ³⁾	230079 ³⁾	

Notes

To obtain the article number for ordering, read under selected part number and actuating voltage from the table.

Devices with dual-voltage coils must be ordered under a single article no.

¹⁾ * = required actuating voltage from the specified range (...-...V).

²⁾ minimum order quantity 10 pcs.

³⁾ minimum order quantity 5 pcs.

RAC24 24 V 50/60 Hz

RAC48 42 - 48 V 50/60 Hz

RAC120 100 - 120 V 50/60 Hz

RAC440 380 - 440 V 50/60 Hz

RAC500 480 - 500 V 50/60 Hz

RDC12 12 - 14 V DC

RDC60 48 - 60 V DC

RDC130 110 - 130 V DC

RDC240 200 - 240 V DC

⁴⁾ TVC100 = 100 V, 50Hz / 100 - 110 V, 60 Hz; voltage tolerance: $(0.85 - 1.1) \times U_c$

⁵⁾ TVC200 = 200 V, 50Hz / 200 - 220 V, 60 Hz; voltage tolerance: $(0.85 - 1.1) \times U_c$

	DILK12-11(...)	DILK20-11(...)	DILK25-11(...)	DILK33-10(...)	DILK50-10(...)			
	Article no.	Article no.	Article no.	Article no.	Article no.			
Standard voltages								
AC	24V50HZ	293967						
	48V50HZ	293968	294000	294022	294044	294066		
	24V60HZ	293981	294003	294025	294047	294069		
	42V50HZ,48V60HZ	293984	294006	294028	294050	294072		
	110V50HZ,120V60HZ	293985	294007	294029	294051	294073		
	190V50HZ,220V60HZ	293986	294008	294030	294052	294074		
	220V50HZ,240V60HZ		294009	294031	294053	294075		
	400V50HZ,440V60HZ	293990	294012	294034	294056	294078		
	415V50HZ,480V60HZ	293991	294013	294035				
	24V50/60HZ		294014	294036	294058	294080		
	48V50/60HZ	106282						
	380V50/60HZ	293996	294018	294040				
Non-standard voltages with the exception of the given standard voltages¹⁾								
AC	*V50HZ(24 - 600V)	293997	294019	294041				
	*V60HZ(24 - 600V)	293998	294020	294042				
		DILMF8-10(...)	DILMF8-01(...)	DILMF11-10(...)	DILMF11-01(...)	DILMF14-10(...)	DILMF14-01(...)	
		Article no.	Article no.	Article no.	Article no.	Article no.	Article no.	
AC	RAC24	104410	104414	104418	104422	104426	104430	
	RAC48	104411	104415	104419	104423	104427	104431	
	RAC120	104412	104416	104420	104424	104428	104432	
		DILMF17-10(...)	DILMF17-01(...)	DILMF25-10(...)	DILMF25-01(...)	DILMF32-10(...)	DILMF32-01(...)	
		Article no.	Article no.	Article no.	Article no.	Article no.	Article no.	
AC	RAC24	104434	104438	104442	104446	104450	104454	
	RAC48	104435	104439	104443	104447	104451	104455	
	RAC120	104436	104440	104444	104448	104452	104456	
		DILMF40(...)	DILMF50(...)	DILMF65(...)	DILMF80(...)	DILMF95(...)	DILMF115(...)	DILMF150(...)
		Article no.	Article no.	Article no.	Article no.	Article no.	Article no.	
AC	RAC24	104458	104462	104466	104470	104474	104478	104482
	RAC48	104459	104463	104467	104471	104475	104479	104483
	RAC120	104460	104464	104468	104472	104476	104480	104484
Notes	<p>To obtain the article number for ordering, read under selected part number and actuating voltage from the table. Devices with dual-voltage coils must be ordered under a single article no. ¹⁾ * = required actuating voltage from the specified range (...-...V); minimum order quantity 10 pcs. RAC24 24 V 50/60 Hz RAC48 42 - 48 V 50/60 Hz RAC120 100 - 120 V 50/60 Hz</p>							

Complete units

	DILM7-32(...)	DILM9-21(...)	DILM9-32(...)	DILM12-21(...)	DILM12-32(...)	DILM17-21(...)	DILM17-32(...)	
	Article no.	Article no.	Article no.	Article no.	Article no.	Article no.	Article no.	
24V50HZ	276642							
230V50/60HZ		276768	276803	276908	276943	277076	277108	
	DILM40-22(...)	DILM50-22(...)	DILM65-22(...)	DILM80-22(...)	DILM95-22(...)	DILM115-22(...)	DILM150-22(...)	
	Article no.	Article no.	Article no.	Article no.	Article no.	Article no.	Article no.	
230V50/60HZ	277806	277870	277934	239457	239535			
400V50HZ,440V60HZ	277800	277864	277928	239451	239529			
RAC120						239577	239597	
RAC440						239579	239599	
	DILM250/22(...)	DILM300A/22(...)	DILM400/22(...)	DILM500/22(...)	DILM580/750	DILM650/22(...)	DILM750/22(...)	DILM820/22(...)
	Article no.	Article no.	Article no.	Article no.	Article no.	Article no.	Article no.	Article no.
RA110	208200	139555	208208	208212	208215	208218	208221	208224
RAC500	208202	139557	208210	208214	208217	208220	208223	208226
RDC48	208199	139554	208207	208211				

Complete device Standard

	DILM250-S/22(...)	DILM300A-S/22(...)	DILM400-S/22(...)	DILM500-S/22(...)
	Article no.	Article no.	Article no.	Article no.
110-120V50/60HZ	274189	139558	274195	274198

Electronic module, incl. coil for comfort model

	DILM250-XSP/E(...)	DILM500-XSP/E(...)	DILM1000-XSP/E(...)
	Article no.	Article no.	Article no.
RA110	208251	208255	289146
RAC500	208253	208257	289147
RDC48	208250	208254	

Electronic module, incl. coil for standard model

	DILM250-S-XSP/E(...)	DILM500-S-XSP/E(...)
	Article no.	Article no.
110-120V50/60HZ	274201	274204

Notes

To obtain the article number for ordering, read under selected part number and actuating voltage from the table.
 Devices with dual-voltage coils must be ordered under a single article no.
 48 – 110 V 40 – 60 Hz/48 – 110 V DC
 RAC120 100 - 120 V 50/60 Hz
 RAC440 380 - 440 V 50/60 Hz
 RAC500 250 - 500 V 40 - 60 Hz/250 - 300 V DC
 RDC48 24 - 48 V DC

Reversing contactor combination

	DIULEEM/21/MV(...)	DIULEM/21/MV(...)	DIULM7/21(...)	DIULM9/21(...)	DIULM12/21(...)	DIULM17/21(...)	DIULM25/21(...)	DIULM32/21(...)
	Article no.	Article no.	Article no.	Article no.	Article no.	Article no.	Article no.	Article no.
110V50HZ, 120V60HZ	051668	051846	278058	278083	278108	278133	278158	278183
230V50HZ, 240V60HZ	051664							
220V50HZ, 240V60HZ			278060					
RAC120								
	DIULM40/11(...)	DIULM50/11(...)	DIULM65/11(...)	DIULM80/11(...)	DIULM95/11(...)	DIULM115/11(...)	DIULM150/11(...)	
	Article no.	Article no.	Article no.	Article no.	Article no.	Article no.	Article no.	
110V50HZ, 120V60HZ	278208	278233	278258	239792	239838			
RAC120						239857	239879	

Star-delta contactor combination

	SDAINLM12(...)	SDAINLM16(...)	SDAINLM22(...)	SDAINLM30(...)	SDAINLM45(...)	SDAINLM55(...)	SDAINLM70(...)	SDAINLM90(...)
	Article no.	Article no.	Article no.	Article no.	Article no.	Article no.	Article no.	Article no.
110V50HZ, 120V60HZ	278283	278308	278333	278358	278383	278408	239892	239922
	SDAINLM115(...)	SDAINLM140(...)	SDAINLM165(...)	SDAINLM200	SDAINLM260(...)			
	Article no.	Article no.	Article no.	Article no.	Article no.			
110V50HZ, 120V60HZ	239960	240006	240032	101007	101028			

Notes To obtain the article number for ordering, read under selected part number and actuating voltage from the table.
 Devices with dual-voltage coils must be ordered under a single article no.
 RAC120 100 - 120 V 50/60 Hz

Engineering

The diagrams show the closing and opening travel of the contacts at no load.

N/O	N/C	x1	x2
DILE AC	N/O	1.9	2.8
	N/C	0.95	2.8
... DILE	N/O	1.9	2.8
	N/C	0.9	2.8
... DDILE	Early-make contact	1.06	2.9
	NC late-break	1.86	2.9
	N/O	1.9	2.8
	N/C	0.9	2.8
DILE DC	N/O	1.9	2.85
	N/C	0.95	2.85
... DILE	N/O	1.9	2.8
	N/C	0.9	2.8
... DDILE	Early-make contact	1.06	2.9
	NC late-break	1.86	2.9
	N/O	1.9	2.8
	N/C	0.9	2.8
DILA-AC	N/O	3.3	4.5
	N/C	1.0	4.5
DILA-XHI	N/O	3.2	4.5
	N/C	1.6	4.5
DILA-XHIV...	Early-make contact	2.0	4.5
	NC late-break	2.8	4.5
	N/O	3.2	4.5
	N/C	1.6	4.5
DILA-DC	N/O	2.1	2.9
	N/C	0.7	2.9
DILA-XHI	N/O	2.3	2.9
	N/C	0.7	2.9
DILA-XHIV	Early-make contact	1.1	2.9
	NC late-break	1.9	2.9
	N/O	2.3	2.9
	N/C	0.7	2.9
DILM7/9 AC	N/O	3.3	4.5
	N/C	1.0	4.5
DILM32-XHI, DILA-XHI	N/O	3.2	4.5
	N/C	1.6	4.5
DILA-XHIV	Early-make contact	2.0	4.5
	NC late-break	2.8	4.5
	N/O	3.2	4.5
	N/C	1.6	4.5
DILM7/9 DC	N/O	2.1	2.9
	N/C	0.7	2.9
DILM32-XHI, DILA-XHI	N/O	2.3	2.9
	N/C	0.7	2.9
DILA-XHIV	Early-make contact	1.1	2.9
	NC late-break	1.9	2.9
	N/O	2.3	2.9
	N/C	0.7	2.9
DILM12/15/P20 AC	N/O	3.3	4.5
	N/C	1.0	4.5
DILM32-XHI, DILA-XHI	N/O	3.2	4.5
	N/C	1.6	4.5
DILA-XHIV	Early-make contact	2.0	4.5
	NC late-break	2.8	4.5
	N/O	3.2	4.5
	N/C	1.6	4.5
DILM12/15/P20 DC	N/O	3.3	4.4
	N/C	1.0	4.4
DILM32-XHI, DILA-XHI	N/O	3.2	4.4
	N/C	1.6	4.4

The diagrams show the closing and opening travel of the contacts at no load.

N/O	N/C	x1	x2
DILA-XHIV...	Early-make contact	2.0	4.4
	NC late-break	2.8	4.4
	N/O	3.2	4.4
	N/C	1.6	4.4
DILM17/25/32/P32/P45	N/O	4.0	6.0
	Auxiliary N/C	1.8	6.0
	Auxiliary N/O	3.2	6.0
DILM32-XHI, DILA-XHI	N/O	3.2	6.0
	N/C	1.6	6.0
DILA-XHIV...	Early-make contact	2.0	6.0
	NC late-break	2.8	6.0
	N/O	3.2	6.0
	N/C	1.6	6.0
DILM40/50/65/P63/P80	N/O	5.1	7.5
DILM150-XHI	N/O	5.7	7.5
	N/C	3.9	7.5
DILM150-XHIV	Early-make contact	3.8	7.5
	NC late-break	5.4	7.5
	N/O	5.7	7.5
	N/C	3.9	7.5
DILM1000-XHI	N/O	5.5	7.5
	N/C	3.6	7.5
DILM1000-XHIV	Early-make contact	4.1	7.5
	NC late-break	5.0	7.5
DILM80/95/115/150/170/P125/P160/P200	N/O	8.0	11
DILM150-XHI	N/O	9.2	11
	N/C	7.4	11
DILM150-XHIV	Early-make contact	7.3	11
	NC late-break	8.9	11
	N/O	9.2	11
	N/C	7.4	11
DILM1000-XHI	N/O	9.0	11
	N/C	7.1	11
DILM1000-XHIV	Early-make contact	7.6	11
	NC late-break	8.5	11
DILM185A/225A	N/O	10.0	13.0
DILM1000-XHI	N/O	10.0	13.0
	N/C	8.1	13.0
DILM1000-XHIV	Early-make contact	8.4	13.0
	NC late-break	9.5	13.0
DILM250/300A	N/O	10.1	13.1
DILM820-XHI	N/O	10.3	13.1
	N/C	8.4	13.1
DILM820-XHIV	Early-make contact	8.7	13.1
	C late-break	9.8	13.1
DILM400/500	N/O	8.9	13.1
DILM820-XHI	N/O	10.3	13.1
	N/C	8.4	13.1
DILM820-XHIV	Early-make contact	8.7	13.1
	NC late-break	9.8	13.1
DILM580/650/750/820	N/O	2.0	4.1
DILM820-XHI	N/O	7.4	10.5
	N/C	5.5	10.5
DILM820-XHIV	Early-make contact	6.0	10.5
	NC late-break	6.8	10.5
DILM1000/1600, DILH1400/2000/2200/2600	N/O	2.0	4.1
DILM820-XHI	N/O	7.4	10.5
	N/C	5.5	10.5
DILM820-XHIV	Early-make contact	6.0	10.5
	NC late-break	6.8	10.5

Components	With top mounting/ auxiliary contacts	With side mounting/ auxiliary contacts	With overload relay	with paralleling link	Insulated housing
Type					
DILE...(-G)(-C)	–	–	–	–	CI-K1-95-TS
	✓	–	–	–	CI-K2-145-TS
DILE...(-G)	✓	–	✓	–	CI-K2-145-AD
	–	–	–	✓	CI-K2-100-TS
	✓	–	–	✓	CI-K2-145-TS
DILM7 – DILM15	✓	–	–	–	CI-K2-145-TS
	✓	–	✓	–	CI-K3-160-TS
DILM17 – DILM32	–	–	–	–	CI-K2-145-TS
	✓	–	✓	–	CI23E-150
DILM40 – DILM65	–	✓	–	–	CI-K3-160-TS
	✓	✓	✓	–	CI43E-150
DILM80 – DILM170	✓	✓	–	–	CI43E-200
	✓	✓	✓	–	CI44E-200
DILM185A	–	✓	–	–	CI48-250
DILM225A	–	✓	–	–	CI48-250
DILM250	–	✓	–	–	CI48-250
DILM300A	–	✓	–	–	CI48-250
DILM400	–	✓	–	–	CI48-250
DILM500	–	✓	–	–	CI48-250
DILM580	–	✓	–	–	CI48-250
DILM650	–	✓	–	–	CI48-250
DILM750	–	✓	–	–	CI48-250
DILM820	–	✓	–	–	CI48-250
DIULE...	✓	–	–	–	CI-K3-125-TS
	✓	–	✓	–	CI-K3-125-TS
DIULM7 – DIULM12	✓	–	–	–	CI-K4-160-TS
DIULM17 – DIULM32	✓	–	–	–	CI23E-150
DIULM40 – DIULM65	✓	–	–	–	CI43E-200
SDAINLM12 – SDAINLM22	✓	–	–	–	CI-K5-160-TS
SDAINLM30 – SDAINLM65	✓	–	–	–	CI23E-150
SDAINLM70 – SDAINLM115	✓	–	–	–	CI43E-200

Rating data

Single-phase rating AC-1

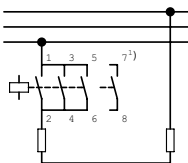

voltage	Max. Back-up fuse
220 V 380 V 660 V	
230 V 400 V 690 V	
240 V 440 V	

P kW	gG/gL A	$I_e = I_{th} (I_{the})$ A
P kW	A	A

Three-phase rating AC-1

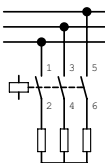

voltage	Max. Back-up fuse
220 V 380 V 660 V	
230 V 400 V 690 V	
240 V 440 V	

P kW	gG/gL A	$I_e = I_{th} (I_{the})$ A
P kW	A	A

Three-phase rating AC-1

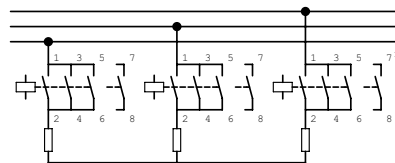

voltage	Max. Back-up fuse
220 V 380 V 660 V	
230 V 400 V 690 V	
240 V 440 V	

P kW	gG/gL A	$I_e = I_{th} (I_{the})$ A
P kW	A	A

open version

Single-phase rating AC-1					Three-phase rating AC-1					Three-phase rating AC-1				
10	18	31	50	50	7	13	20	20	20	18	31	54	50	50
10	18	31	50	50	7	13	20	20	20	18	31	54	50	50
12	21	37	63	60	-	-	-	-	-	21	37	65	63	60
10	18	31	-	50	7	13	22	-	20	18	31	54	-	50
13	22	38	-	60	-	-	-	-	-	22	38	65	-	60
18	32	55	-	88	13	22	38	-	35	32	55	95	-	88
21	36	63	-	100	14	25	43	-	40	36	63	109	-	100
26	45	78	-	125	18	31	54	-	50	45	78	136	-	125
34	59	102	-	163	24	41	71	-	65	59	102	176	-	163
42	72	125	-	200	29	50	87	-	80	72	125	217	-	200
47	81	141	-	225	33	56	98	-	90	81	141	244	-	225
57	99	172	-	275	40	69	119	-	110	100	172	299	-	275
68	117	204	-	325	47	81	141	-	130	118	203	353	-	325
84	144	251	-	400	58	100	174	-	160	145	250	434	-	400
101	175	317	-	460	70	120	220	-	185	175	302	549	-	460
144	248	431	800	688	100	172	299	315	275	262	453	786	-	688
165	284	494	800	788	114	197	342	315	315	300	519	900	-	788
172	297	516	1000	825	120	206	357	400	330	333	576	1000	-	875
183	316	548	1000	875	126	219	380	400	350	381	658	1143	-	1000
261	451	784	1250	1250	181	313	543	500	500	476	825	1429	-	1250
366	632	1097	-	1750	253	438	760	800	700	667	1152	2000	-	1750
418	722	1254	-	2000	290	500	869	800	800	762	1316	2286	-	2000
444	767	1332	-	2125	308	531	923	1000	850	810	1400	2429	-	2125
470	812	1411	-	2250	326	563	977	1000	900	857	1480	2572	-	2250
523	903	1568	-	2500	362	625	1086	1000	1000	953	1646	2858	-	2500
627	1084	1882	-	3000	434	750	1303	-	1200	1144	1975	3430	-	3000
732	1264	2195	-	3500	507	875	1520	-	1400	1334	2300	4000	-	3500
1045	1805	3135	-	5000	724	1251	2172	-	2000	1905	3290	5716	-	5000
1150	1985	3449	-	5500	796	1376	2389	-	2200	2095	3619	6288	-	5500
1358	2346	4075	-	6500	941	1626	2827	-	2600	2476	4277	7430	-	6500

Notes

¹⁾ Contacts 7 - 8 only with DILEM4(-G), DILMP20...

²⁾ Rated operational current at 60 °C

Type	Ordering data	Required Accessories: Parallel connector	Notes
------	---------------	---	-------

AC operated

	Page	Type		Page
DILEM-10(...)	→ 1/8	P1DILEM	Accessories Auxiliary contact modules	→ 1/10
DILEM-01(...)	→ 1/8	P1DILEM		→ 1/44
DILEM4(...)	→ 1/8	P1DILEM	set of paralleling links	→ 1/67
DILM7-...(…)	→ 1/24	DILM12-XP1	Surface mounting enclosure	→ 1/93
DILMP20(...)	→ 1/42	DILM12-XP1	Accessories	→ 1/66
DILM17-...(…)	→ 1/24	DILM32-XP1		
DILM25-...(…)	→ 1/24	DILM32-XP1		
DILM40(...)	→ 1/32	DILM65-XP1		
DILM50(...)	→ 1/32	DILM65-XP1		
DILM65(...)	→ 1/26	DILM65-XP1		
DILM80(...)	→ 1/26	DILM150-XP1		
DILM95(...)	→ 1/26	DILM150-XP1		
DILM115(...)	→ 1/26	DILM150-XP1		
DILM150(...)	→ 1/26	DILM150-XP1		
DILM170(...)	→ 1/26	DILM150-KP1		
DILM185A(...)	→ 1/38	DILM185-XP1		
DILM225A(...)	→ 1/38	DILM185-XP1		
DILM250(...)	→ 1/36	–		
DILM300A(...)	→ 1/36	–		
DILM400(...)	→ 1/36	–		
DILM500(...)	→ 1/36	–		
DILM580(...)	→ 1/38	–		
DILM650(...)	→ 1/38	–		
DILM750(...)	→ 1/38	–		
DILM820(...)	→ 1/38	–		
DILH1200(...)	→ 1/40	–		
DILH1400(...)	→ 1/40	–		
DILH2000(...)	→ 1/40	–		
DILH2200(...)	→ 1/40	–		
DILH2600(...)	→ 1/40	–		

1

DILA (AC-15)

Component lifespan (operations)
 I_e = Rated operational current

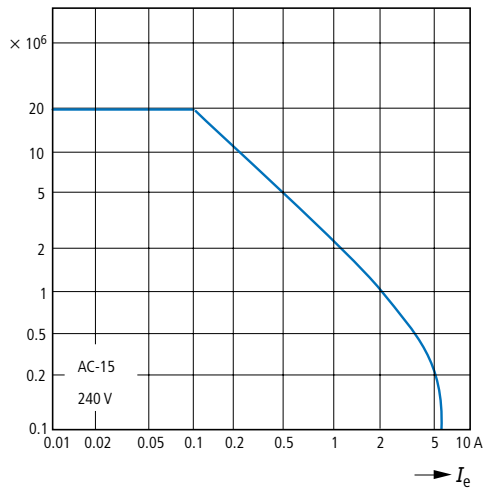

DILA (DC)¹⁾

Component lifespan (operations)
 I_e = Rated operational current

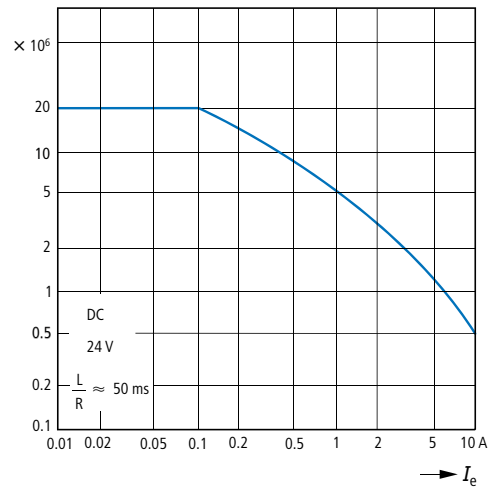

¹⁾ Three contacts in series

DILER (AC-15)

Component lifespan (operations)
 I_e = Rated operational current

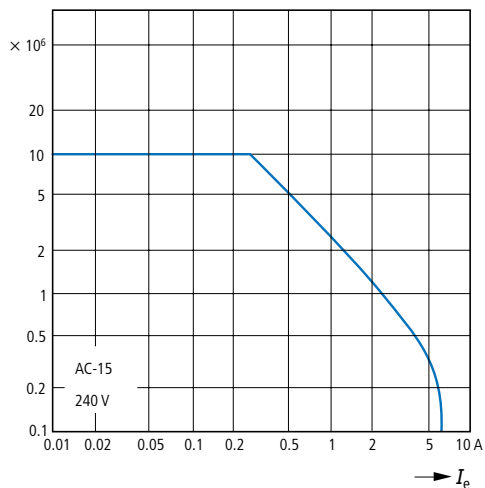

Normal switching duty

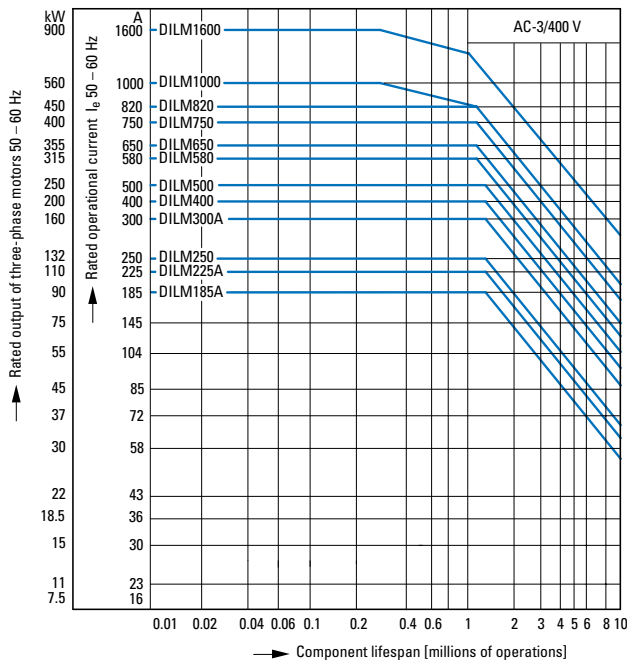
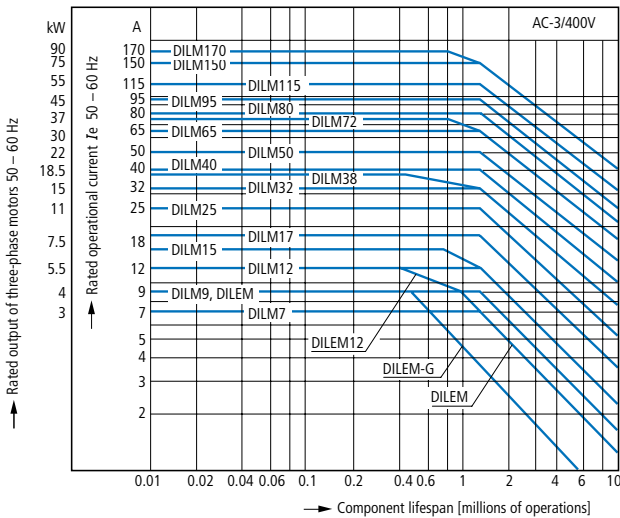

Extreme switching duty

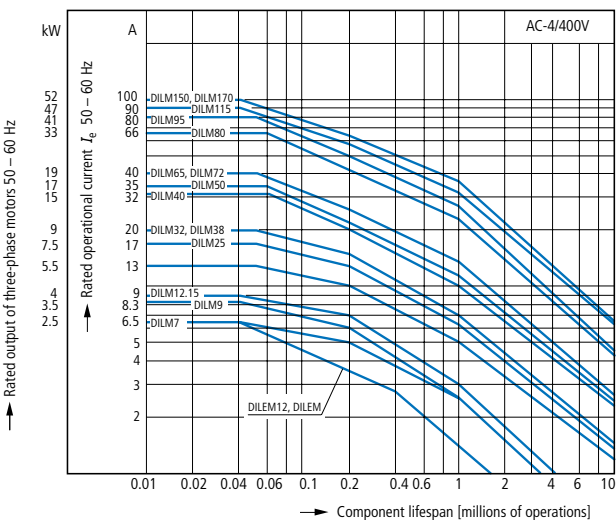

Normal AC induction motor

Operating characteristics

Switch on: from stop

Switch off: during run

Electrical characteristics:

Switch on: up to 6 × rated motor current

Switch off: up to 1 × rated motor current

Utilization category

100 % AC-3

Typical applications

- Compressors
- Pumps
- Fan
- Hinged flaps
- Elevators (Lifts)
- Escalators
- Conveyor belts
- Bucket-elevator
- Mixers
- Agitators
- Centrifuges
- Air-conditioning systems
- General drives for manufacturing and processing machines

Normal AC induction motor

Operating characteristics

Inching, plugging, reversing

Electrical characteristics:

Switch on: up to 6 × rated motor current

Switch off: up to 6 × rated motor current

Utilization category

100 % AC-4

Typical applications

- Printing machines
- Wire-drawing machines
- Centrifuges
- Special drives on manufacturing and processing machines

1

Extreme switching duty

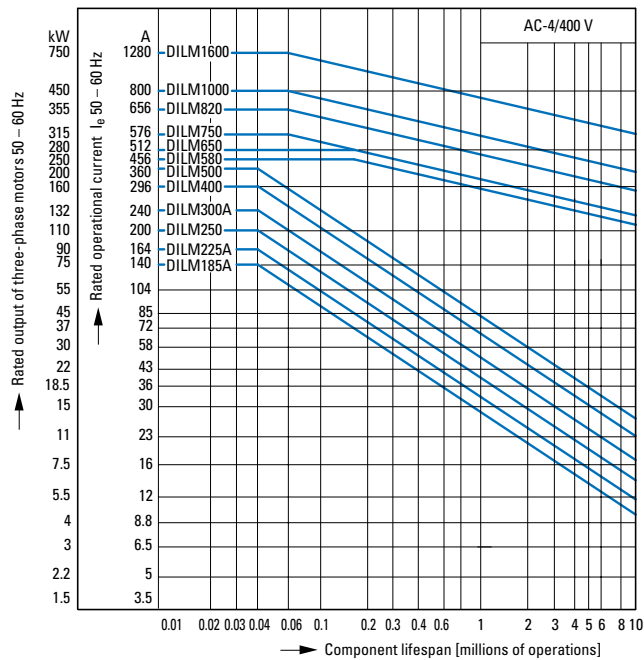

Normal AC induction motor

Operating characteristics

Inching, plugging, reversing

Electrical characteristics:

Switch on: up to $6 \times$ rated motor current

Switch off: up to $6 \times$ rated motor current

Utilization category

100 % AC-4

Typical applications

- Printing machines
- Wire-drawing machines
- Centrifuges
- Special drives on manufacturing and processing machines

Switching conditions for 3 pole, non-motor loads

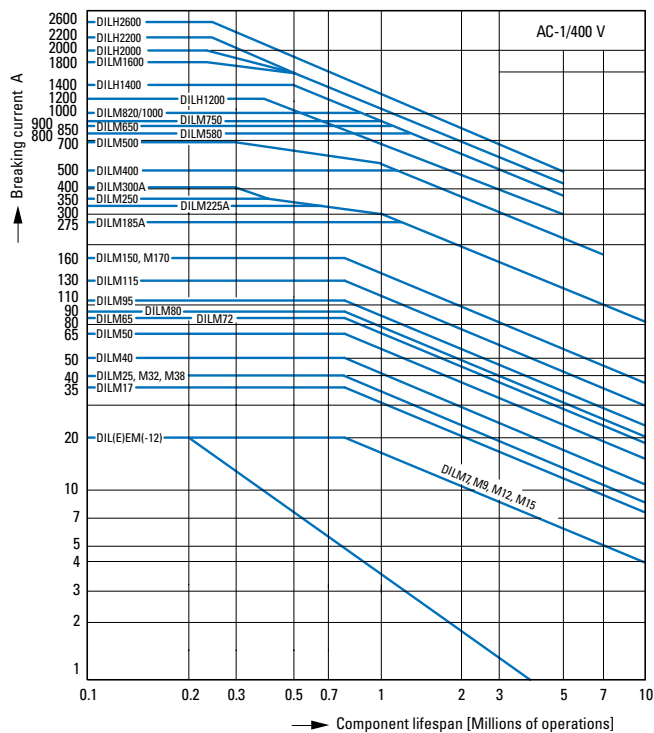

Operating characteristics

Non inductive and slightly inductive loads

Electrical characteristics:

Switch on: $1 \times$ rated operational current

Switch off: $1 \times$ rated operational current

Utilization category

100 % AC-1

Typical applications

Electric heat

Switching conditions for 4 pole, non-motor loads

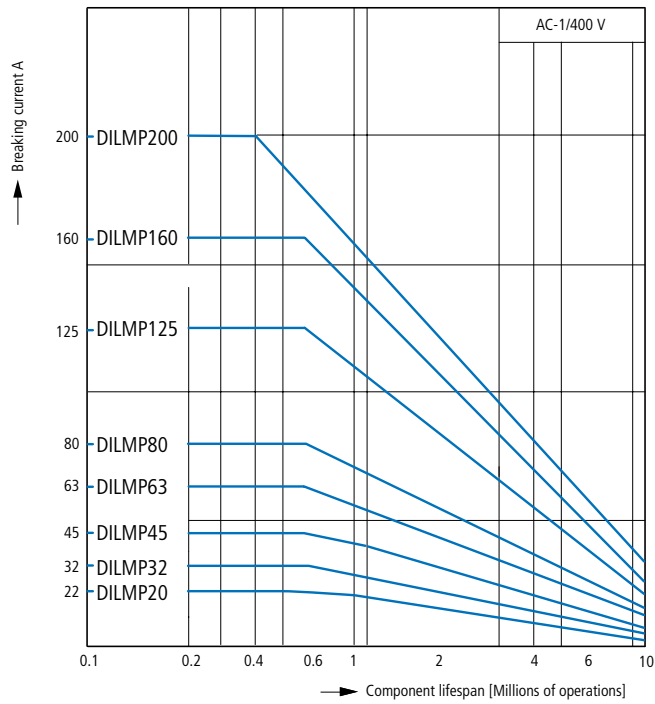

- Operating characteristics
 - Non inductive and slightly inductive loads
- Electrical characteristics:
 - Switch on: 1 x rated operational current
 - Switch off: 1 x rated operational current
- Utilization category
 - 100 % AC-1
- Typical applications
 - Electric heat

1

Short-time loading 3 pole

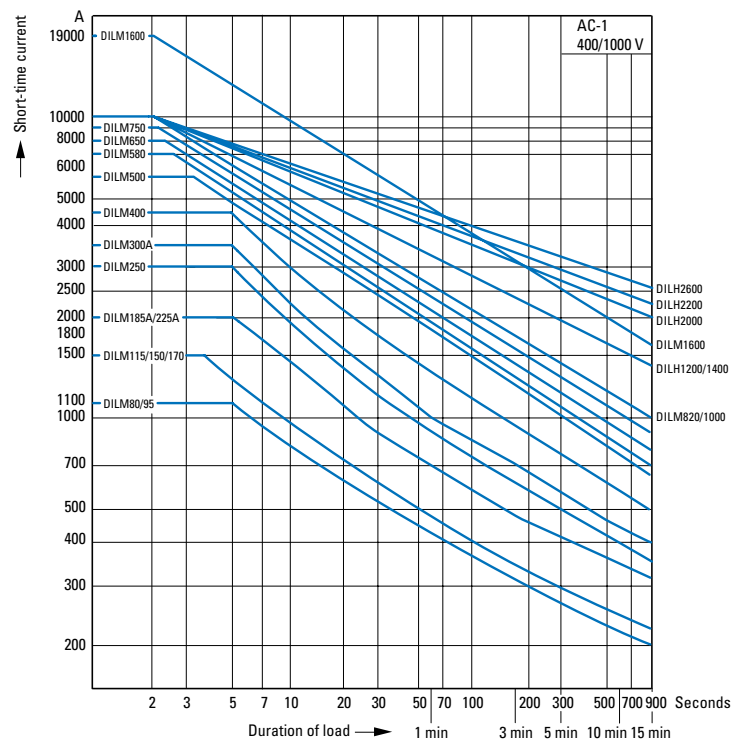
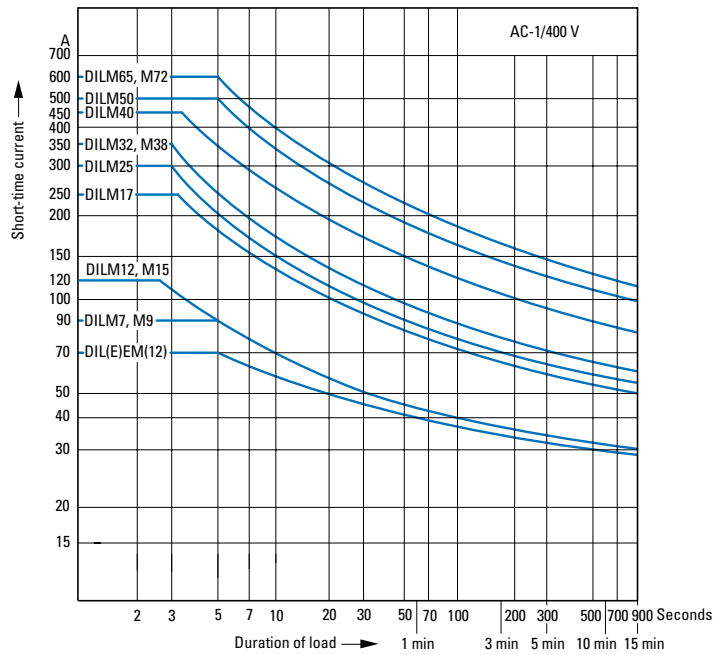

Determination of the max. operating frequency dependent on the rating and utilization category (recommended values) for 400 V

P_N = max. Rated motor output (kW) of the respective contactor → Page 1/8

S/h = max. Operations per hour

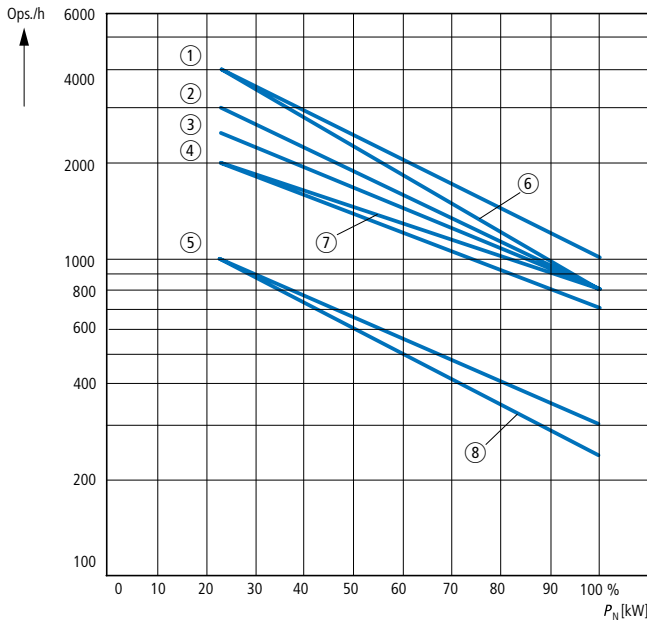

Type	Characteristic curve AC-1	AC-3	AC-2 AC-4
DILE(E)M(-12)	7	6	8
DILM7, DILM9, DILM12, DILM15	3	1	5
DILM17, DILM25, DILM32, DILM38	3	2	5
DILM40, DILM50, DILM65, DILM72	3	2	5
DILM80, DILM95, DILM115, DILM150, DILM170	3	7	5

Determination of the max. operating frequency dependent on the rating and utilization category (recommended values) for 400 V

P_N = max. Rated motor output (kW) of the respective contactor → Page 1/36

S/h = max. Operations per hour

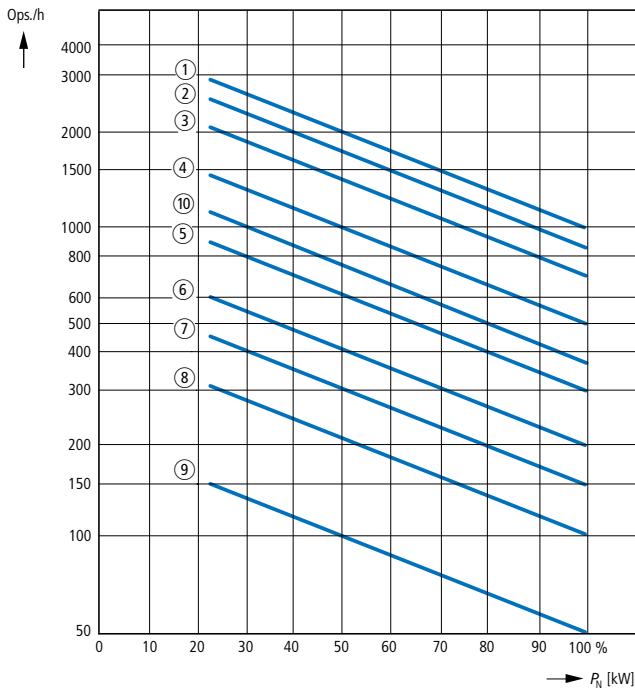

Type	Characteristic curve AC-1	AC-3	AC-4
DILM185A	2	1	8
DILM225A	2	1	8
DILM250	2	1	8
DILM300A	3	2	9
DILM400	3	2	9
DILM500	3	2	9
DILM580	3	4	7
DILM650	3	4	7
DILM750	3	4	7
DILM820	3	4	7
DILM1000	3	4	7
DILM1600	10	10	7
DILH1400	10	-	-
DILH2000	10	-	-
DILH2200	10	-	-
DILH2600	10	-	-

DC current switching

	Without overload relay ≤ 60 V DC	> 60 V DC	With overload relay > 60 V DC
----- When necessary, cable to be supplied by customer			
DILEEM – DILM170			
1-pole			
2-pole			
DILEM4			
DILMP...			
1-pole			
2-pole			

Wiring, star-delta combination with DILM32-XTEY20

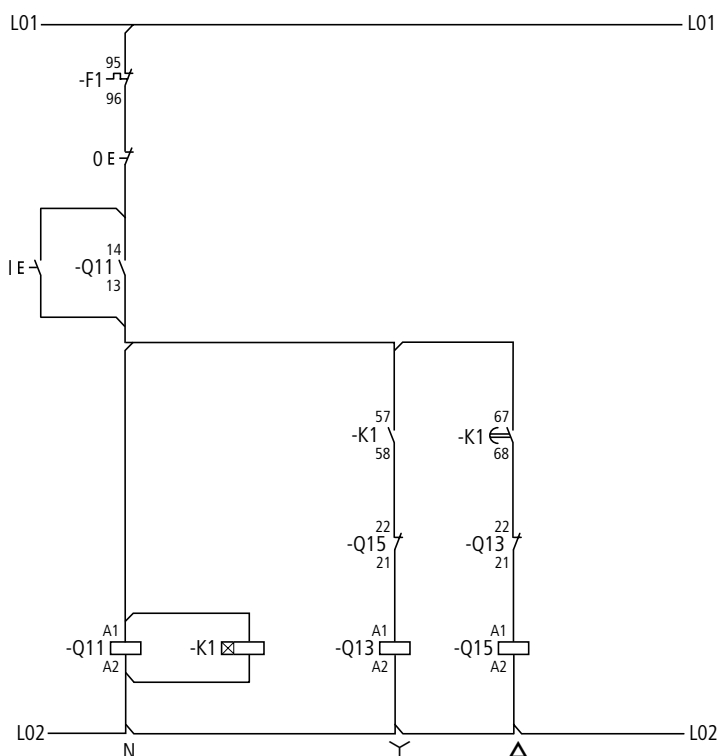

Technical data

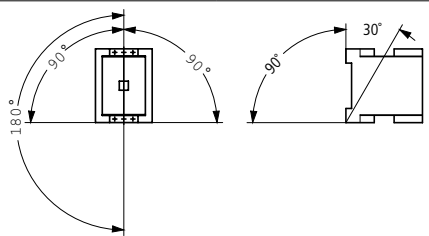
		DILA DILAS	DILA...XHI	DILER	...DILE
General					
Standards		IEC/EN 60947, EN 60947-5-1, VDE 0660, UL, CSA			
Lifespan, mechanical					
AC operated	Operations	x 10 ⁶ 20	10	10	10
DC operated	Operations	x 10 ⁶ 20	10	20	20
Maximum operating frequency		Operations/h	9000	9000	9000
Climatic proofing		Damp heat, constant, to IEC 60068-2-78 Damp heat, cyclic, to IEC 60068-2-30			
Ambient temperature					
Open	°C	-25 - 60	-25 - 60	-25 - 50	-25 - 50
Enclosed	°C	-25 - 40	-25 - 40	-25 - 40	-25 - 40
Storage	°C	-40 - 80	-40 - 80		
Mounting position					
Mechanical shock resistance (IEC/EN 60068-2-27), half-sinusoidal shock 10 ms					
Basic devices with auxiliary contact module					
N/O	g	7	7	10	10
N/C	g	5	5	8	8
Protection rating		IP20	IP20	IP20	IP20
Busbar tag shroud when actuated from front (EN 50274)		Finger- and back-of-hand proof			
Weight					
AC operated	kg	→ Data sheet in online catalog			
DC operated	kg	→ Data sheet in online catalog			
Terminal capacities (Cu cable)					
Screw terminals					
Solid	mm ²	1 x (0.75 - 4) 2 x (0.75 - 2.5)	1 x (0.75 - 2.5) 2 x (0.75 - 2.5)	1 x (0.75 - 2.5) 2 x (0.75 - 2.5)	1 x (0.75 - 2.5) 2 x (0.75 - 2.5)
Flexible with ferrules	mm ²	1 x (0.75 - 2.5) 2 x (0.75 - 2.5)	1 x (0.75 - 1.5) 2 x (0.75 - 1.5)	1 x (0.75 - 1.5) 2 x (0.75 - 1.5)	1 x (0.75 - 1.5) 2 x (0.75 - 1.5)
Solid or stranded	AWG	18 - 14	18 - 14	18 - 14	18 - 14
Stripping length		mm	10	10	10
Terminal Screw		M3.5	M3.5	M3.5	M3.5
Pozi driv screwdriver		Size	2	2	2
Standard screwdriver		mm	0.8 x 5.5 1 x 6	0.8 x 5.5 1 x 6	0.8 x 5.5 1 x 6
max. Tightening torque		Nm	1.2	1.2	1.2
Spring-loaded terminals					
Solid	mm ²	1 x (0.75 - 2.5) 2 x (0.75 - 2.5)	1 x (0.75 - 2.5) 2 x (0.75 - 2.5)	1 x (1 - 2.5) 2 x (1 - 2.5)	1 x (1 - 2.5) 2 x (1 - 2.5)
Flexible with ferrules	mm ²	1 x (0.75 - 1.5) 2 x (0.75 - 1.5)	1 x (0.75 - 1.5) 2 x (0.75 - 1.5)	1 x (1 - 2.5) 2 x (1 - 2.5)	1 x (1 - 2.5) 2 x (1 - 2.5)
Flexible without ferrules DIN 46228	mm ²	1 x (0.75 - 2.5) 2 x (0.75 - 2.5)	1 x (0.75 - 1.5) 2 x (0.75 - 1.5)	–	–
Solid or stranded	AWG	18 - 14	18 - 14	1 x (16 - 14) 2 x (16 - 14)	1 x (16 - 14) 2 x (16 - 14)
Stripping length		mm	10	10	10
Standard screwdriver		mm	0.6 x 3.5	0.6 x 3.5	0.6 x 3.5

			DILA DILAS	DILA...XHI	DILER	...DILE
Contacts						
Interlocked opposing contacts to EN 60947-5-1 appendix L, including auxiliary contact module (no NO early-makes and NC late-breaks)			yes	yes	yes	yes
Rated impulse withstand voltage	U_{imp}	V AC	6000	6000	6000	6000
Overvoltage category/degree of pollution			III/3	III/3	III/3	III/3
Rated insulation voltage	U_i	V AC	690	690	690	690
Rated operating voltage	U_e	V AC	690	500	600	600
Safe isolation according to EN 61140						
between coil and auxiliary contacts			V AC	400	300	300
Between the auxiliary contacts			V AC	400	300	300
Rated operational current						
AC-15						
220/230/240 V	I_e	A	4	4	6	4
380/400/415 V	I_e	A	4	4	3	2
500 V	I_e	A	1.5	1.5	1.5	1.5
DC ¹⁾						
L/R ≤ 15 ms						
Contacts in series:						
1	24 V	A	10	10	2.5	2.5
1	60 V	A	6	6	–	–
2	60 V	A	10	10	2.5	2.5
1	110 V	A	3	3	–	–
3	110 V	A	6	6	1.5	1.5
1	220 V	A	1	1	–	–
3	220 V	A	5	5	0.5	0.5
L/R ≤ 50 ms						
Contacts in series:						
3	24 V	A	4	2.5	–	–
3	60 V	A	4	1	–	–
3	110 V	A	2	0.5	–	–
3	220 V	A	1	0.25	–	–
DC-13 (6xP)						
Contacts in series:						
3	24 V	A	2.5	2.5	–	–
3	60 V	A	1	1	–	–
3	110 V	A	0.5	0.5	–	–
3	220 V	A	0.25	0.25	–	–
Contact reliability (for $U_e = 24$ V DC, $U_{min} = 17$ V, $I_{min} = 5.4$ mA)			Fault probability	λ	< 10^{-8} (i.e. less than one failure per 100 million switchings)	
Conventional thermal current			I_{th}	A	16	10
Short-circuit rating without welding						
Maximum overcurrent protection device						
220/230/240 V			PKZM0	4	–	4
380/400/415 V			PKZM0	4	–	4
Short-circuit protection max. Fuse						
500 V			A gG/gL	10	10	6
500 V			fast-acting	–	–	10
Current heat loss at load of I_{th}						
AC operated			W	0.53	2.6	1.1
DC operated			W	1.07 (DILA) 0.85 (DILAC)	2.6	1.1

Notes¹⁾ Switch-on and switch-off conditions based on DC-13, time constant as specified

			DILA DILAS	DILA...XHI	DILER	...DILE
Magnet systems						
Voltage tolerance						
AC operated						
	Single-voltage coil 50 Hz and dualvoltage coil 50 Hz, 60 Hz	Pick-up	x U _c 0.8 - 1.1	–	0.8 - 1.1	–
	Dual-frequency coil 50/60 Hz	Pick-up	x U _c 0.8 - 1.1	–	0.85 - 1.1	–
	general	Drop-out	x U _c 0.3 - 0.6	–	0.2 - 0.75	–
DC operated ¹⁾						
	Pick-up voltage	Pick-up	x U _c 0.8 x 1.1	–	0.85 - 1.3	–
	At 24 V: without auxiliary contact module (40 °C)	Pick-up	x U _c 0.7 - 1.3	–	0.7 - 1.3	–
	general	Drop-out	x U _c 0.15 - 0.6	–	0.1 - 0.75	–
Power consumption						
	50 Hz	Pick-up	VA 24	–	25	–
	50 Hz	Hold	VA 3.4	–	4.6	–
	50 Hz	Hold	W 1.4	–	1.3	–
	60 Hz	Pick-up	VA 30	–	25	–
	60 Hz	Hold	VA 4.4	–	4.6	–
	60 Hz	Hold	W 1.4	–	1.8	–
	50/60 Hz	Pick-up	VA 27 25	–	30 29	–
	50/60 Hz	Hold	VA 4.2 3.3	–	5.4 3.9	–
	50/60 Hz	Hold	W 1.4 1.2	–	1.6 1.1	–
	DC operated	Pick-up = sealing	W 2.6	–	2.3	–
Duty factor			% ED 100	–	100	–
Changeover times at 100% U _c (recommended values)						
	AC operated closing delay	ms	15 - 21	–	14 - 21	–
	AC operated normally open opening delay	ms	9 - 18	–	8 - 18	–
	max. AC operated closing delay with auxiliary module	ms	–	–	45	45
	DC operated closing delay	ms	31	–	26 - 35	–
	DC operated normally open opening delay	ms	12	–	15 - 25	–
	max. DC operated closing delay with auxiliary module	ms	–	–	70	70
Rating data for approved types						
Auxiliary contact						
Pilot duty						
	AC operated		A600	A600	A600	A600
	DC operated		P300	P300	P300	P300
General Use						
	AC	V	600	600	600	600
	AC	A	15	10	10	10
	DC	V	250	250	250	250
	DC	A	1	1	0.5	0.5

Notes¹⁾ Smoothed DC voltage, three-phase bridge rectifiers or smoothed double-wave bridge rectification

		ETS4-VS3	DILM32-XTE	CMD(24VDC) CMD(220-240VAC)
General				
Standards		IEC/EN 60947, VDE 0660, UL, CSA	DIN EN 61812, IEC/EN 60947, VDE 0660, UL, CSA	IEC/EN 60947-5-1, UL, CSA
Lifespan, mechanical				
AC operated	Operations	x 10 ⁶	–	3
DC operated	Operations	x 10 ⁶	30	3
Maximum operating frequency				
DC operated	Operations	x 10 ⁶	72000	–
Climatic proofing				
		Damp heat, constant, to IEC 60068-2-78 Damp heat, cyclic, to IEC 60068-2-30		
Ambient temperature				
Open	°C	-25 - 60	-25 - 60	-5 - 50
Enclosed	°C	-25 - 45	-25 - 40	–
Storage	°C	–	-40 - 80	-40 - 80
Mounting position				
		Any	As required, except suspended	Any
Mechanical shock resistance (IEC/EN 60068-2-27)				
Half-sinusoidal shock 20 ms				
N/O	g	10	–	–
Half-sinusoidal shock 10 ms				
N/O	g	–	6	4
N/C	g	–	6	4
Protection rating				
		IP20	IP20	IP20
Busbar tag shroud when actuated from front (EN 50274)				
		Finger- and back-of-hand proof		
Weight				
		kg	0.09	0.08
Terminal capacities (Cu cable)				
Solid	mm ²	1 x (0.75 - 2.5) 2 x (0.75 - 2.5) ¹⁾	1 x (0.75 - 2.5) 2 x (0.75 - 1.5)	1 x (0.5 - 2.5) 2 x (0.5 - 1.5)
flexible with ferrule	mm ²	1 x (0.75 - 2.5) 2 x (0.75 - 1.5) ¹⁾	1 x (0.75 - 1.5) 2 x (0.75 - 1.5)	1 x (0.5 - 2.5) 2 x (0.5 - 1.5)
Solid or stranded	AWG	16 - 14	18 - 14	20 - 14
Terminal Screw				
		M3.5	M3.5	M3.5
Poqidriv screwdriver				
		Size	2	2
Standard screwdriver				
		mm	0.8 x 5.5 1 x 6	0.8 x 5.5 1 x 6
max. Tightening torque				
		Nm	1.2	1.2
Notes				
		¹⁾ Use only equal cross-sections		

			ETS4-VS3	DILM32-XTE	CMD(24VDC)	CMD(220-240VAC)
Contacts						
Rated impulse withstand voltage	U_{imp}	V AC	6000	4000	800	4000
Overvoltage category/degree of pollution			III/2	III/3	III/3	III/3
Rated insulation voltage	U_i	V AC	440	250	100	250
Rated operating voltage	U_e	V	440 AC	250 AC	24 DC	240 AC
Rated operational current						
AC-15						
220/240 V	I_e	A	2	3	–	–
380/415 V	I_e	A	2	–	–	–
DC-13 ¹⁾						
DC-13 L/R \leq 15 ms						
Contacts in series:						
1	24 V	A	2.6	1	–	–
1	60 V	A	1	0.2	–	–
1	110 V	A	0.6	0.2	–	–
1	220 V	A	0.2	0.1	–	–
DC-13 L/R \leq 50 ms						
Contacts in series:						
1	24 V	A	2	1	–	–
1	60 V	A	0.6	0.2	–	–
1	110 V	A	0.08	0.2	–	–
1	220 V	A	0.08	0.1	–	–
DC-13 L/R \leq 300 ms						
Contacts in series:						
1	24 V	A	0.6	1	–	–
1	60 V	A	0.2	0.2	–	–
1	110 V	A	0.08	0.2	–	–
1	220 V	A	0.03	0.1	–	–
Safe isolation according to EN 61140						
Between coil and auxiliary contacts		V AC	–	250	–	–
Between the auxiliary contacts		V AC	–	250	–	–
Contact reliability (for $U_e = 24$ V DC, $U_{min} = 17$ V, $I_{min} = 5.4$ mA)	Fault probability	λ	$< 10^{-8}$ (i.e. less than one failure per 100 million switchings)	–	–	–
Conventional thermal current	I_{th}	A	6	4	–	–
Component lifespan						
AC-15						
230 V, $I_e = 0.1$ A	Operations	$\times 10^6$	7	–	–	–
230 V, $I_e = 1.2$ A	Operations	$\times 10^6$	1	–	–	–
Short-circuit strength without welding						
Short-circuit protection max. Fuse						
500 V		A gG/gL	–	4	2	2
500 V		A fast-acting	4	–	–	–

Notes¹⁾ Switch-on and switch-off conditions based on DC-13, time constant as specified

				ETS4-VS3	DILM32-XTE	CMD(24VDC) CMD(220-240VAC)
Magnet systems						
Voltage tolerance						
Pick-up voltage						
AC operated	Pick-up	$x U_c$	–		0.85 - 1.1	0.85 - 1.1
DC operated ¹⁾	Pick-up	$x U_c$	0.85 - 1.2		0.7 - 1.2	0.85 - 1.1
Power consumption						
AC operated	Hold	VA	–		2	4
AC operated	Hold	W	–		1.8	4
DC operated	Pick-up = sealing	W	0.6		–	4
Duty factor		% ED	100		100	100
Changeover times at 100 % U_c (recommended values)						
DC operated closing delay		ms	7		–	–
DC operated opening delay		ms	3		–	–
Maximum operating frequency		ops./h	–		3600	–
Maximum operating frequency in combination with side-mounting auxiliary contact		ops./h	–		360	–
Minimum on duration						
On-delayed		ms	–		< 50	–
Released-delayed		ms	–		< 200	–
Repetition accuracy (with constant parameters)		Discrepancy	%	–	< 5	–
Recovery time (after 100% time delay)			ms	–	70	–
Contact changeover time						
DILM32-XTEE11/DILM32-XTED11	t_{ij}	ms	–		10	–
DILM32-XTEY20	t_{ij}	ms	–		50	–
CMD	t_{ij}	ms	–		–	100 ±20%

Notes ¹⁾ Smoothed DC voltage, three-phase bridge rectifiers or smoothed double-wave bridge rectification

			DILEEM DILEM DILEM12	DILEEM-G DILEM-G DILEM12-G	DILEM4	DILEM4-G
General						
Standards			IEC/EN 60947, VDE 0660, CSA, UL			
Lifespan, mechanical; Coil 50/60 Hz	Operations	x 10 ⁶	DILEEM: 7 DILEM: 7 DILEM12: 5	–	7	–
Lifespan, mechanical	Operations	x 10 ⁶	DILEEM: 10 DILEM: 10 DILEM12: 5	DILEEM-G: 20 DILEM-G: 20 DILEM12-G: 5	20	20
Maximum operating frequency						
mechanical		ops./h	9000	9000	9000	9000
electrical (Contactor without overload relay)		Characteristic curves, → Page 1/96				
Climatic proofing			Damp heat, constant, to IEC 60068-2-78 Damp heat, cyclic, to IEC 60068-2-30			
Ambient temperature						
Open	°C		-25 - 50	-25 - 50	-25 - 50	-25 - 50
Enclosed	°C		-25 - 40	-25 - 50	-25 - 50	-25 - 50
Storage	°C		- 40 - 80	- 40 - 80	- 40 - 80	- 40 - 80
Mounting position			Any, except for vertically with terminals A1/A2 below			
Mechanical shock resistance (IEC/EN 60068-2-27), half-sinusoidal shock 10 ms						
Basic device without auxiliary contact module						
Main contacts normally open		g	10	10	10	10
Main contacts normally closed/normally open		g	10/8	10/8	–	–
Basic devices with auxiliary contact module						
Main contacts normally open		g	10	10	10	10
Main contacts normally open/normally closed		g	20/20	20/20	20/20	20/20
Protection rating			IP20			
Busbar tag shroud when actuated from front (EN 50274)			Finger- and back-of-hand proof			
Weight		kg	0.17	0.21	0.17	0.21
Terminal capacity: main and auxiliary contacts (Cu cable)						
Screw terminals						
Solid		mm ²	1 x (0.75 - 2.5) 2 x (0.75 - 2.5)	1 x (0.75 - 2.5) 2 x (0.75 - 2.5)	1 x (0.75 - 2.5) 2 x (0.75 - 2.5)	1 x (0.75 - 2.5) 2 x (0.75 - 2.5)
flexible with ferrule		mm ²	1 x (0.75 - 1.5) 2 x (0.75 - 1.5)	1 x (0.75 - 1.5) 2 x (0.75 - 1.5)	1 x (0.75 - 1.5) 2 x (0.75 - 1.5)	1 x (0.75 - 1.5) 2 x (0.75 - 1.5)
Solid or stranded		AWG	18 - 14	18 - 14	18 - 14	18 - 14
Stripping length		mm	8	8	8	8
Terminal Screw			M3.5	M3.5	M3.5	M3.5
Pozidriv screwdriver		Size	2	2	2	2
Standard screwdriver		mm	0.8 x 5.5 1 x 6	0.8 x 5.5 1 x 6	0.8 x 5.5 1 x 6	0.8 x 5.5 1 x 6
max. Tightening torque		Nm	1.2	1.2	1.2	1.2
Spring-loaded terminals						
flexible with ferrule		mm ²	1 x (1 - 2.5) 2 x (1 - 2.5)	1 x (1 - 2.5) 2 x (1 - 2.5)	1 x (1 - 2.5) 2 x (1 - 2.5)	1 x (1 - 2.5) 2 x (1 - 2.5)
Solid or stranded		AWG	16 - 14	16 - 14	16 - 14	16 - 14
Stripping length		mm	10	10	10	10
Standard screwdriver		mm	0.6 x 3.5	0.6 x 3.5	0.6 x 3.5	0.6 x 3.5

				DILEEM DILEEM-G	DILEM DILEM-G	DILEM4	DILEM4-G	DILEM12 DILEM12-G
Main circuits								
Rated impulse withstand voltage		U_{imp}	V AC	6000	6000	6000	6000	6000
Overvoltage category/degree of pollution				III/3	III/3	III/3	III/3	III/3
Rated insulation voltage		U_i	V AC	690	690	690	690	690
Rated operating voltage		U_e	V AC	690	690	690	690	690
Safe isolation according to EN 61140								
	between coil and contacts		V AC	300	300	300	300	300
	between the contacts		V AC	300	300	300	300	300
Making capacity of up to 440 V ($\cos \varphi$ as specified in IEC/EN 60947)				A	110	110	110	120
Breaking capacity								
	220/230 V		A	90	90	90	90	96
	380/400 V		A	90	90	90	90	96
	500 V		A	64	64	64	64	72
	660/690 V		A	42	42	42	42	42
Component lifespan								
	AC-1			→ Page 1/96				
	AC-3			→ Page 1/94				
	AC-4			→ Page 1/94				
Short-circuit protection max. Fuse								
	Type "2" coordination, 500 V		gL/gG A	10	10	10	10	20
	Type "1" coordination, 500 V		gL/gG A	20	20	20	20	35
Alternating voltage								
AC-1 operation								
Conventional thermal current, 3-pole, 50 - 60 Hz								
	Open	at 40 °C	$I_{th} = I_e$	A	22	22	22	22
		at 50 °C	$I_{th} = I_e$	A	20	20	20	20
	enclosed ¹⁾		$I_{th} = I_e$	A	16	16	16	16
Conventional thermal current 1-pole								
	Open ¹⁾		$I_{th} = I_e$	A	50	50	60	50
	enclosed ¹⁾		$I_{th} = I_e$	A	40	40	50	40
AC-3 operation								
Rated operational current AC-3 open, 50 - 60 Hz, 3-pole ¹⁾	220/230 V		I_e	A	6.6	9	9	12
	240 V		I_e	A	6.6	9	9	12
	380/400 V		I_e	A	6.6	9	9	12
	415 V		I_e	A	6.6	9	9	10.5
	440 V		I_e	A	6.6	9	9	10.5
	500 V		I_e	A	5	6.4	6.4	9
	660/690 V		I_e	A	3.5	4.8	4.8	5.2
Motor rating	220/230 V		P	kW	1.5	2.2	2.2	3
	240 V		P	kW	1.8	2.5	2.5	3
	380/400 V		P	kW	3	4	4	5.5
	415 V		P	kW	3.1	4.3	4.3	5.5
	440 V		P	kW	3.3	4.6	4.6	5.5
	500 V		P	kW	3	4	4	5.5
	660/690 V		P	kW	3	4	4	4
AC-4 operation								
Rated operational current AC-4 open, 50 - 60 Hz, 3-pole ¹⁾	220/230 V		I_e	A	5	6.6	6.6	6.6
	240 V		I_e	A	5	6.6	6.6	6.6
	380/400 V		I_e	A	5	6.6	6.6	6.6
	415 V		I_e	A	5	6.6	6.6	6.6
	440 V		I_e	A	5	6.6	6.6	6.6
	500 V		I_e	A	3.7	5	5	5
	660/690 V		I_e	A	2.9	3.4	3.4	3.4
Motor rating	220/230 V		P	kW	1.1	1.5	1.5	1.5
	240 V		P	kW	1.3	1.8	1.8	1.5
	380/400 V		P	kW	2.2	3	3	3
	415 V		P	kW	2.3	3.1	3.1	3
	440 V		P	kW	2.4	3.3	3.3	3
	500 V		P	kW	2.2	3	3	3
	660/690 V		P	kW	2.2	3	3	3

Notes¹⁾ At maximum permissible ambient air temperature

				DILEEM	DILEEM-G	DILEM	DILEM-G	DILEM4	DILEM4-G	DILEM12	DILEM12-G
DC Voltage											
Connections				→ Page 1/102							
Rated operational current open											
DC-1	12 V	I_b	A	20	20	20	20	20	20	20	20
	24 V	I_b	A	20	20	20	20	20	20	20	20
	60 V	I_b	A	20	20	20	20	20	20	20	20
	110 V	I_b	A	20	20	20	20	20	20	20	20
	220 V	I_b	A	20	20	20	20	20	20	20	20
Current heat loss (3-pole or 4-pole)											
At I_{th} , 50 °C			W	5.5	5.5	2.9	4.4	7.9	5.9	5.9	4.4
At I_b to AC-3/400 V			W	0.6	0.6	1.2	0.9	–	–	2.1	1.8
Magnet systems											
Voltage tolerance											
Single-voltage coil 50 Hz and dual-voltage coil 50 Hz, 60 Hz		Pick-up	$x U_c$	0.8 - 1.1	–	0.8 - 1.1	–	0.8 - 1.1	–	0.8 - 1.1	–
Dual-frequency coil 50/60 Hz		Pick-up	$x U_c$	0.8 - 1.1	–	0.85 - 1.1	–	0.85 - 1.1	–	0.8 - 1.1	–
DC operated		Pick-up	$x U_c$	–	0.8 - 1.1	–	0.8 - 1.1	–	0.85 - 1.1	–	0.8 - 1.1
Power consumption											
AC operation	Single-voltage coil 50 Hz and dual-voltage coil 50 Hz, 60 Hz	Pick-up	VA	25	–	25	–	25	–	25	–
		Pick-up	W	22	–	22	–	22	–	22	–
		Hold	VA	4.6	–	4.6	–	4.6	–	4.6	–
		Hold	W	1.8	–	1.8	–	1.8	–	1.8	–
	Dual-frequency coil 50/60 Hz at 50 Hz	Pick-up	VA	30	–	30	–	30	–	30	–
		Pick-up	W	26	–	26	–	26	–	26	–
		Hold	VA	5.4	–	5.4	–	5.4	–	5.4	–
		Hold	W	1.6	–	1.6	–	1.6	–	1.6	–
	Dual-frequency coil 50/60 Hz at 60 Hz	Pick-up	VA	29	–	29	–	29	–	29	–
		Pick-up	W	24	–	24	–	24	–	24	–
		Hold	VA	3.9	–	3.9	–	3.9	–	3.9	–
		Hold	W	1.1	–	1.1	–	1.1	–	1.1	–
	Single-voltage coil 50 Hz and dual-voltage coil 50 Hz, 60 Hz	Pick-up	VA	25	–	25	–	25	–	25	–
		Pick-up	VA	30	–	30	–	30	–	30	–
	Dual-frequency coil 50/60 Hz at 50 Hz	Pick-up	VA	29	–	29	–	29	–	29	–
		Pick-up	VA	29	–	29	–	29	–	29	–
DC operation ¹⁾	Power consumption pick-up = sealing	VA/W	–	2.3	–	2.3	–	2.3	–	2.3	
		% ED	100	100	100	100	100	100	100	100	
Duty factor											
Switching times at 100 % U_c											
N/O	Closing delay min.	ms	14	26	14	26	14	26	14	26	
	Closing delay max.	ms	21	35	21	35	21	35	21	35	
	Opening delay min.	ms	8	15	8	15	8	15	8	15	
	Opening delay max.	ms	18	25	18	25	18	25	18	25	
	max. Closing delay with top mounting auxiliary contact	ms	45	70	45	70	45	70	45	70	
Reversing contactors	Changeover time at 110 % U_c										
	Changeover time min.	ms	16	40	16	40	16	40	16	40	
	Changeover time max.	ms	21	50	21	50	21	50	21	50	
max. Arcing time at 690 V AC		ms	12	12	12	12	12	12	12	12	
Coil	Lifespan, mechanical; coil 50/60 Hz	Operations $\times 10^6$	7	–	7	–	7	–	7	–	

Notes ¹⁾ Smoothed DC or three-phase bridge rectifier

	DILE(E)M(-12)...			...DILEM
Auxiliary contact				
Positive operating contacts to EN 60947-5-1 appendix L, including auxiliary contact module			yes	yes
Rated impulse withstand voltage	U_{imp}	V AC	6000	6000
Overvoltage category/degree of pollution			III/3	III/3
Rated insulation voltage	U_i	V AC	690	690
Rated operating voltage	U_e	V AC	600	600
Safe isolation according to EN 61140				
Between coil and auxiliary contacts		V AC	300	300
Between the auxiliary contacts		V AC	300	300
Rated operational current				
AC-15				
220/240 V	I_e	A	6	4
380/415 V	I_e	A	3	2
500 V	I_e	A	1.5	1.5
DC				
time \leq 15 ms				
Contacts in series:				
1	24 V	A	2.5	2.5
2	60 V	A	2.5	2.5
3	100 V	A	1.5	1.5
3	220 V	A	0.5	0.5
Conventional thermal current	I_{th}	A	10	10
Contact reliability (for $U_e = 24$ V DC, $U_{min} = 17$ V, $I_{min} = 5.4$ mA)	Fault probability	λ	$< 10^{-8}$ (i.e. less than one failure per 100 million switchings)	
Component lifespan at $U_e = 240$ V				
AC-15	Operations	$\times 10^6$	0.2	0.2
DC ¹⁾ , time = 50 ms: 2 contacts in a row at $I_e = 0.5$ A	Operations	$\times 10^6$	0.15	0.15
Short-circuit strength without welding				
Maximum overcurrent protective device			PKZM0-4	PKZM0-4
Short-circuit protection max. Fuse				
500 V		A gG/gL	6	6
500 V		A fast-acting	10	10
Current heat loss at a load of I_{th} per contact		W	1.1	1.5

Notes ¹⁾ Switch-on and switch-off conditions based on DC-13, time constant as specified

			DILEEM	DILEM	DILEM4	...DILEM
Rating data for approved types						
Switching capacity						
Maximum motor rating						
3-phase						
	200 V, 208 V	HP	1.5	2	2	–
	230 V/240 V	HP	2	3	3	–
	460 V, 480 V	HP	3	5	5	–
	575 V, 600 V	HP	3	5	5	–
1-phase						
	115 V, 120 V	HP	0.25	0.5	0.5	–
	230 V, 240 V	HP	1	1.5	1.5	–
General use		A	15	15	15	–
Auxiliary contact						
Pilot duty						
AC operated			A600	A600	–	A600
DC operated			P300	P300	–	P300
General Use						
AC		V	600	600	–	600
AC		A	10	10	–	10
DC		V	250	250	–	250
DC		A	0.5	0.5	–	0.5
Short Circuit Current Rating						
Basic Rating						
SCCR		kA	5	5	5	–
max. Fuse		A	45	45	45	–

			DILM(S)7	DILM(S)9	DILM(S)12	DILM15	DILM(S)17	DILM(S)25
General								
Standards			IEC/EN 60947, VDE 0660, UL, CSA					
Lifespan, mechanical								
AC operated	Operations	x 10 ⁶	10	10	10	10	10	10
DC operated	Operations	x 10 ⁶	10	10	10	10	10	10
Operating frequency, mechanical								
AC operated	Operations/h		9000	9000	9000	5000	5000	5000
DC operated	Operations/h		9000	9000	9000	5000	5000	5000
Maximum electrical switching frequency (contactors without overload relay)			Characteristic curves → Page 1/101					
Climatic proofing			Damp heat, constant, to IEC 60068-2-78; Damp heat, cyclic, to IEC 60068-2-30					
Ambient temperature								
Open	°C		-25 - 60	-25 - 60	-25 - 60	-25 - 60	-25 - 60	-25 - 60
Enclosed	°C		-25 - 40	-25 - 40	-25 - 40	-25 - 40	-25 - 40	-25 - 40
Storage	°C		-40 - 80	-40 - 80	-40 - 80	-40 - 80	-40 - 80	-40 - 80
Mounting position AC- and DC operated								
Mechanical shock resistance (IEC/EN 60068-2-27), half-sinusoidal shock 10 ms								
Main contacts								
N/O	g		10	10	10	10	10	10
Auxiliary contacts								
N/O	g		7	7	7	7	7	7
N/C	g		5	5	5	5	5	5
Mechanical shock resistance (IEC/EN 60068-2-27) when table-mounted, half-sinusoidal shock 10 ms								
Main contacts								
N/O	g		5.7	5.7	5.7	5.7	6.9	6.9
Auxiliary contacts								
N/O	g		3.4	3.4	3.4	3.4	5.3	5.3
N/C	g		3.4	3.4	3.4	3.4	3.5	3.5
Protection rating			IP20 IP20 IP20 IP20 IP00 IP00					
Busbar tag shroud when actuated from front (EN 50274)			Finger- and back-of-hand proof					
Weight								
AC operated	kg		0.3	0.3	0.24	0.24	0.5	0.5
DC operated	kg		0.3	0.3	0.3	0.3	0.6	0.6
Terminal type, screw connection								
Terminal capacities, main cable (Cu)								
Solid	mm ²		1 x (0.75 - 4) 2 x (0.75 - 2.5)				1 x (0.75 - 16) 2 x (0.75 - 10)	
flexible with ferrule	mm ²		1 x (0.75 - 2.5) 2 x (0.75 - 2.5)				1 x (0.75 - 16) 2 x (0.75 - 10)	
Stranded	mm ²		-				1 x 16 1 x 16	
Solid or stranded	AWG		single 18 - 10, double 18 - 14				single 18 - 6, double 18 - 8	
Flat conductor	mm	Number of segments x width x thickness	-				-	
Stripping length	mm		10	10	10	10	10	10
Terminal capacity control circuit cable (Cu)								
Solid	mm ²		1 x (0.75 - 4) 2 x (0.75 - 2.5)				Complete units: 1 x (0.75 - 2.5) 2 x (0.75 - 2.5)	
flexible with ferrule	mm ²		1 x (0.75 - 2.5) 2 x (0.75 - 2.5)					
Solid or stranded	AWG		18 - 14	18 - 14	18 - 14	18 - 14	18 - 14	18 - 14
Stripping length	mm		10	10	10	10	10	10

DILM(S)32	DILM38	DILM(S)40	DILM(S)50	DILM(S)65	DILM72	DILM(S)80	DILM(S)95	DILM(S)115	DILM(S)150	DILM170
IEC/EN 60947, VDE 0660, UL, CSA										
10	10	10	10	10	10	10	10	10	10	10
10	10	10	10	10	10	10	10	10	10	10
5000	5000	5000	5000	5000	5000	3600	3600	3600	3600	3000
5000	5000	5000	5000	5000	5000	3600	3600	3600	3600	3000
Damp heat, constant, to IEC 60068-2-78; Damp heat, cyclic, to IEC 60068-2-30										
-25 - 60	-25 - 60	-25 - 60	-25 - 60	-25 - 60	-25 - 60	-25 - 60	-25 - 60	-25 - 60	-25 - 60	-25 - 60
-25 - 40	-25 - 40	-25 - 40	-25 - 40	-25 - 40	-25 - 40	-25 - 40	-25 - 40	-25 - 40	-25 - 40	-25 - 40
-40 - 80	-40 - 80	-40 - 80	-40 - 80	-40 - 80	-40 - 80	-40 - 80	-40 - 80	-40 - 80	-40 - 80	-40 - 80
10	10	10	10	10	10	10	10	10	10	10
7	7	7	7	7	7	7	7	7	7	7
5	5	5	5	5	5	5	5	5	5	5
6.9	6.9	10	10	10	10	10	10	10	10	10
5.3	5.3	7	7	7	7	7	7	7	7	7
3.5	3.5	5	5	5	5	5	5	5	5	5
IP00	IP00	IP00	IP00	IP00	IP00	IP00	IP00	IP00	IP00	IP00
Finger- and back-of-hand proof										
0.5	0.43	0.92	0.92	0.92	0.87	2.22	2.22	2.31	2.31	2.25
0.6	0.48	1.1	1.1	1.1	1.05	2.32	2.32	2.31	2.31	2.25
1 x (0.75 - 16) 2 x (0.75 - 10)		1 x (0.75 - 16) 2 x (0.75 - 16)								
1 x (0.75 - 16) 2 x (0.75 - 10)		1 x (0.75 - 35) 2 x (0.75 - 25)				1 x (10 - 70) 2 x (10 - 50)		1 x (10 - 95) 2 x (10 - 70)		
1 x 16	1 x 16	1 x (16 - 50) 2 x (16 - 35)				1 x (16 - 70) 2 x (16 - 50)		1 x (16 - 95) 2 x (16 - 70)		
single 18 - 6, double 18 - 8		single 14 - 1, double 14 - 2				single 8 - 3/0, double 8 - 2/0				
-	-	2 x (6 x 9 x 0,8)				2 x (6 x 16 x 0,8)				
10	10	14	14	14	14	24	24	24	24	24
1 x (0.75 - 4) 2 x (0.75 - 2.5)										
Complete units: 1 x (0.75 - 2.5) 2 x (0.75 - 2.5)										
1 x (0.75 - 2.5) 2 x (0.75 - 2.5)										
18 - 14	18 - 14	18 - 14	18 - 14	18 - 14	18 - 14	18 - 14	18 - 14	18 - 14	18 - 14	18 - 14
10	10	10	10	10	10	10	10	10	10	10

			DILM(S)7	DILM(S)9	DILM(S)12	DILM15	DILM(S)17	DILM(S)25
General								
Main cable connection screw/bolt			M3.5	M3.5	M3.5	M3.5	M5	M5
Tightening torque	Nm		1.2	1.2	1.2	1.2	3.2	3.2
Control circuit cable connection screw/bolt			M3.5	M3.5	M3.5	M3.5	M3.5	M3.5
Tightening torque	Nm		1.2	1.2	1.2	1.2	1.2	1.2
Tool								
Main conductors								
Pozidriv screwdriver		Size	2	2	2	2	2	2
Hexagon socket-head screw	SW	mm	–	–	–	–	–	–
Standard screwdriver		mm	0.8 x 5.5 1 x 6	0.8 x 5.5 1 x 6	0.8 x 5.5 1 x 6	0.8 x 5.5 1 x 6	0.8 x 5.5 1 x 6	0.8 x 5.5 1 x 6
Control circuit cable								
Pozidriv screwdriver		Size	2	2	2	2	2	2
Standard screwdriver		mm	0.8 x 5.5 1 x 6	0.8 x 5.5 1 x 6	0.8 x 5.5 1 x 6	0.8 x 5.5 1 x 6	0.8 x 5.5 1 x 6	0.8 x 5.5 1 x 6
Terminal type spring-loaded terminal								
Terminal capacities, main cable (Cu)								
Solid		mm ²	1 x (0.75 - 2.5) 2 x (0.75 - 2.5)				–	–
Flexible		mm ²	1 x (0.75 - 2.5) 2 x (0.75 - 2.5)				–	–
flexible with ferrule		mm ²	1 x (0.75 - 1.5) 2 x (0.75 - 1.5)				–	–
Flexible without ferrule		mm ²	1 x (0.75 - 2.5) 2 x (0.75 - 2.5)				–	–
Solid or stranded		AWG	single 18 - 12, double 18 - 14				–	–
Terminal capacity control circuit cable (Cu)								
Solid		mm ²	1 x (0.75 - 2.5) 2 x (0.75 - 2.5)					
Flexible		mm ²	1 x (0.75 - 2.5) 2 x (0.75 - 2.5)					
flexible with ferrule		mm ²	1 x (0.75 - 1.5) 2 x (0.75 - 1.5)					
Flexible without ferrule		mm ²	1 x (0.75 - 2.5) 2 x (0.75 - 2.5)				–	–
Solid or stranded		AWG	18 - 14	18 - 14	18 - 14	18 - 14	18 - 14	18 - 14
Tool								
Stripping length		mm	10	10	10	10	10	10
Screwdriver blade width		mm	3.5	3.5	3.5	3.5	3.5	3.5
Main circuits								
Rated impulse withstand voltage	U_{imp}	V AC	8000	8000	8000	8000	8000	8000
Overvoltage category/degree of pollution			III/3	III/3	III/3	III/3	III/3	III/3
Rated insulation voltage	U_i	V AC	690	690	690	690	690	690
Rated operating voltage	U_e	V AC	690	690	690	690	690	690
Safe isolation according to EN 61140								
between coil and contacts		V AC	400	400	400	400	440	440
between the contacts		V AC	400	400	400	400	440	440
Making capacity (cos ϕ to IEC/EN 60947)	Up to 690 V	A	112	AC: 112 DC: 126	AC: 144 DC: 168	155	238	350
Breaking Capacity								
220V/230 V		A	70	90	120	124	170	250
380/400 V		A	70	90	120	124	170	250
500 V		A	50	70	100	100	170	250
660/690 V		A	40	50	70	70	120	150
Short-circuit rating								
Short-circuit protection max. Fuse								
Type of coordination "2"								
400 V	gG/gL 500 V	A	20	20	20	20	35	35
690 V	gG/gL 690 V	A	16	16	20	20	35	35
Type of coordination "1"								
400 V	gG/gL 500 V	A	35	35	35	63	63	100
690 V	gG/gL 690 V	A	20	20	25	50	50	50

DILM(S)32	DILM38	DILM(S)40	DILM(S)50	DILM(S)65	DILM72	DILM(S)80	DILM(S)95	DILM(S)115	DILM(S)150	DILM170
M5	M5	M6	M6	M6	M6	M10	M10	M10	M10	M10
3.2	3.2	3.3	3.3	3.3	3.3	14	14	14	14	14
M3.5	M3.5	M3.5	M3.5	M3.5	M3.5	M3.5	M3.5	M3.5	M3.5	M3.5
1.2	1.2	1.2	1.2	1.2	1.2	1.2	1.2	1.2	1.2	1.2
2	2	2	2	2	2	–	–	–	–	–
–	–	–	–	–	–	5	5	5	5	5
0.8 x 5.5 1 x 6	0.8 x 5.5 1 x 6	0.8 x 5.5 1 x 6	0.8 x 5.5 1 x 6	0.8 x 5.5 1 x 6	0.8 x 5.5 1 x 6	–	–	–	–	–
2	2	2	2	2	2	2	2	2	2	2
0.8 x 5.5 1 x 6	0.8 x 5.5 1 x 6	0.8 x 5.5 1 x 6	0.8 x 5.5 1 x 6	0.8 x 5.5 1 x 6	0.8 x 5.5 1 x 6	0.8 x 5.5 1 x 6	0.8 x 5.5 1 x 6	0.8 x 5.5 1 x 6	0.8 x 5.5 1 x 6	0.8 x 5.5 1 x 6
–	–	–	–	–	–	–	–	–	–	–
–	–	–	–	–	–	–	–	–	–	–
–	–	–	–	–	–	–	–	–	–	–
–	–	–	–	–	–	–	–	–	–	–
–	–	–	–	–	–	–	–	–	–	–
1 x (0.75 - 2.5) 2 x (0.75 - 2.5)										
1 x (0.75 - 2.5) 2 x (0.75 - 2.5)										
1 x (0.75 - 1.5) 2 x (0.75 - 1.5)										
–	–	–	–	–	–	–	–	–	–	–
18 - 14	18 - 14	18 - 14	18 - 14	18 - 14	18 - 14	18 - 14	18 - 14	18 - 14	18 - 14	18 - 14
10	10	10	10	10	–	10	10	10	10	–
3.5	3.5	3.5	3.5	3.5	–	3.5	3.5	3.5	3.5	–
8000	8000	8000	8000	8000	8000	8000	8000	8000	8000	8000
III/3	III/3	III/3	III/3	III/3	III/3	III/3	III/3	III/3	III/3	III/3
690	690	690	690	690	690	690	690	690	690	690
690	690	690	690	690	690	690	690	690	690	690
440	440	440	440	440	440	690	690	690	690	690
440	440	440	440	440	440	690	690	690	690	690
384	384	560	700	910	910	1120	1330	1610	2100	2100
320	320	400	500	650	650	800	950	1150	1500	1500
320	320	400	500	650	650	800	950	1150	1500	1500
320	320	400	500	650	650	800	950	1150	1500	1500
180	180	250	320	370	370	650	800	1100	1200	1320
63	63	63	80	125	125	160	160	250	250	250
35	35	50	63	80	80	160	160	250	250	250
125	125	125	160	250	250	250	250	250	250	250
63	63	80	80	100	100	200	200	250	250	250

				DILM(S)7	DILM(S)9	DILM(S)12	DILM15	DILM(S)17	DILM(S)25	
Alternating voltage										
AC-1 operation										
Conventional thermal current 3-pole, 50 - 60 Hz	Open	at 40 °C	$I_{th} = I_e$	A	22	22	22	22	40	45
		at 50 °C	$I_{th} = I_e$	A	21	21	21	21	38	43
		at 55 °C	$I_{th} = I_e$	A	21	21	21	21	37	42
		at 60 °C	$I_{th} = I_e$	A	20	20	20	20	35	40
Conventional free air thermal current 1-pole	Open		$I_{th} = I_e$	A	50	50	50	50	88	100
	Enclosed		$I_{th} = I_e$	A	45	45	45	45	80	90
AC-3 operation										
Rated operational current AC-3 open, 3-pole, 50 - 60 Hz	220/230 V		I_e	A	7	9	12	15.5	18	25
	240 V		I_e	A	7	9	12	15.5	18	25
	380/400 V		I_e	A	7	9	12	15.5	18	25
	415 V		I_e	A	7	9	12	15.5	18	25
	440 V		I_e	A	7	9	12	15.5	18	25
	500 V		I_e	A	5	7	10	12.5	18	25
	660/690 V		I_e	A	4	5	7	9	12	15
Motor rating	220/230 V	P		kW	2.2	2.5	3.5	4	5	7.5
	240 V	P		kW	2.2	3	4	4.6	5.5	8.5
	380/400 V	P		kW	3	4	5.5	7.5	7.5	11
	415 V	P		kW	4	5.5	7	8	10	14.5
	440 V	P		kW	4.5	5.5	7.5	8.4	10.5	15.5
	500 V	P		kW	3.5	4.5	7	7.5	12	17.5
	660/690 V	P		kW	3.5	4.5	6.5	7	11	14
AC-4 operation										
Rated operational current AC-4 open, 3-pole, 50 - 60 Hz	220/230 V		I_e	A	5	6	7	7	10	13
	240 V		I_e	A	5	6	7	7	10	13
	380/400 V		I_e	A	5	6	7	7	10	13
	415 V		I_e	A	5	6	7	7	10	13
	440 V		I_e	A	5	6	7	7	10	13
	500 V		I_e	A	4.5	5	6	6	10	13
	660/690 V		I_e	A	4	4.5	5	5	8	10
Motor rating	220/230 V	P		kW	1	1.5	2	2	2.5	3.5
	240 V	P		kW	1.5	1.6	2.2	2.2	3	4
	380/400 V	P		kW	2.2	2.5	3	3	4.5	6
	415 V	P		kW	2.3	2.8	3.4	3.4	5	6.5
	440 V	P		kW	2.4	3	3.6	3.6	5.5	7
	500 V	P		kW	2.5	2.8	3.5	3.5	6	8
	660/690 V	P		kW	2.9	3.6	4.4	4.4	6.5	8.5
DC Voltage										
Connections					Switching from DC → Page 1/102					
Rated operational current I_e open										
DC-1-operation	60 V		I_e	A	20	20	20	20	35	40
	110 V		I_e	A	20	20	20	20	35	40
	220 V		I_e	A	15	15	15	15	35	40

DILM(S)32	DILM38	DILM(S)40	DILM(S)50	DILM(S)65	DILM72	DILM(S)80	DILM(S)95	DILM(S)115	DILM(S)150	DILM170
45	45	60	80	98	98	110	130	160	190	225
43	43	57	71	88	88	98	125	142	180	200
42	42	55	68	83	83	94	115	135	170	190
40	40	50	65	80	80	90	110	130	160	185
36	36	45	58	72	72	80	100	115	144	166
100	100	125	162	200	200	225	275	325	400	460
90	90	112	145	180	180	200	250	285	360	415
32	38	40	50	65	72	80	95	115	150	170
32	38	40	50	65	72	80	95	115	150	170
32	38	40	50	65	72	80	95	115	150	170
32	38	40	50	65	72	80	95	115	150	170
32	38	40	50	65	72	80	95	115	150	170
32	38	40	50	65	72	80	95	115	150	170
18	22.5	25	32	37	37	65	80	93	100	100
10	11	12.5	15.5	20	22	25	30	37	48	52
11	12	13.5	17	22	25	27.5	32	40	52	57
15	18.5	18.5	22	30	37	37	45	55	75	90
19	20	24	30	39	41	48	57	70	91	100
20	21	25	32	41	44	51	60	75	95	105
23	24	28	36	47	50	58	70	85	110	120
17	21	23	30	35	35	63	75	90	96	96
15	15	18	21	25	25	40	50	55	65	65
15	15	18	21	25	25	40	50	55	65	65
15	15	18	21	25	25	40	50	55	65	65
15	15	18	21	25	25	40	50	55	65	65
15	15	18	21	25	25	40	50	55	65	65
15	15	18	21	25	25	40	50	55	65	65
12	12	14	17	20	20	27	37	45	50	50
4	4	5	6	7	7	11.5	16	17	20	20
4.5	4.5	5.5	6.5	7.5	7.5	13	17	19	22	22
7	7	9	10	12	12	20	26	28	33	33
7.5	7.5	9.5	11	13	13	24	30	33	39	39
8	8	10	12	14	14	25	32	35	41	41
9	9	11	13	16	16	29	36	40	47	47
10	10	12	14	17	17	26	35	43	48	48
40	40	50	60	72	72	110	110	160	160	160
40	40	50	50	72	72	110	110	160	160	160
40	40	45	45	65	65	70	70	90	90	90

			DILM(S)7	DILM(S)9	DILM(S)12	DILM15	DILM(S)17	DILM(S)25
Current heat loss (3 pole)			AC	AC	AC	AC		
		DC	DC	DC	DC	DC		
Current heat loss at I_{th} (60 °C)	W		2.4 4.5	3 4.4	2.5 4.2	2.5 4	7.9	10.8
Current heat loss at I_g to AC-3/400 V	W		0.3	0.6 0.9	0.9 1.5	1.5 2.4	2.1	4.2
Impedance per pole	mΩ		2.5 4.6	2.5 4.6	2.5 4.6	2.5 4.6	2.7	2.7
Magnet systems								
Voltage tolerance								
AC operated	Pick-up	$x U_c$	0.8 - 1.1	0.8 - 1.1	0.8 - 1.1	0.8 - 1.1	0.8 - 1.1	0.8 - 1.1
AC operated	Drop-out	$x U_c$	0.3 - 0.6	0.3 - 0.6	0.3 - 0.6	0.3 - 0.6	0.3 - 0.6	0.3 - 0.6
DC operated ³⁾	Pick-up	$x U_c$	0.8 - 1.1 ¹⁾	0.8 - 1.1 ¹⁾	0.8 - 1.1 ¹⁾	0.8 - 1.1 ¹⁾	0.7 - 1.2 ²⁾	0.7 - 1.2 ²⁾
DC operated ³⁾	Drop-out	$x U_c$	0.15 - 0.6	0.15 - 0.6	0.15 - 0.6	0.15 - 0.6	0.15 - 0.6	0.15 - 0.6
Power consumption of the coil in a cold state and $1.0 \times U_c$								
50 Hz	Pick-up	VA	24	24	24	24	52	52
50 Hz	Hold	VA	3.4	3.4	3.4	3.4	7.1	7.1
50 Hz	Hold	W	1.4	1.4	1.4	1.4	2.1	2.1
60 Hz	Pick-up	VA	30	30	30	30	67	67
60 Hz	Hold	VA	4.4	4.4	4.4	4.4	8.7	8.7
60 Hz	Hold	W	1.4	1.4	1.4	1.4	2.1	2.1
50/60 Hz	Pick-up	VA	27 25	27 25	27 25	27 25	62 58	62 58
50/60 Hz	Hold	VA	4.2 3.3	4.2 3.3	4.2 3.3	4.2 3.3	9.1 6.5	9.1 6.5
50/60 Hz	Hold	W	1.4 1.2	1.4 1.2	1.4 1.2	1.4 1.2	2.1	2.1
DC operated	Pick-up	W	2.6	4.5	4.5	4.5	12	12
DC operated	Hold	W	2.6	4.5	4.5	4.5	0.9	0.9
Duty factor	% ED		100	100	100	100	100	100
Changeover times at 100 % U_c (recommended values)								
Main contacts								
AC operated	Closing time	ms	15 - 21	15 - 21	15 - 21	15 - 21	16 - 22	16 - 22
	Opening time	ms	9 - 18	9 - 18	9 - 18	9 - 18	8 - 14	8 - 14
DC operated	Closing time	ms	31	31	31	31	47	47
	Opening time	ms	12	12	12	12	30	30
Arcing time		ms	10	10	10	10	10	10
Permissible residual current when A1 - A2 are actuated from the electronic system (with 0 signal)		mA	–	–	–	–	–	–
Lifespan, mechanical; Coil 50/60 Hz	at 50 Hz	Mechanical lifespan at 50 Hz approx. 30% less than specified on page 1/116 under "Lifespan, mechanical AC operated".						

Electromagnetic compatibility (EMC)

Emitted interference EN 60947-1

Noise Immunity EN 60947-1

Notes

- ¹⁾ at ...VDC: 0.85 - 1.1 only with auxiliary contact modules with 3 or more N/C at 24 V DC: 0.7 - 1.3 without auxiliary contact module and ambient air temperature +40 °C
- ²⁾ RDC 12 (U_{min} 12 V DC/ U_{max} 14 V DC)
RDC 24 (U_{min} 24 V DC/ U_{max} 27 V DC)
RDC 60 (U_{min} 48 V DC/ U_{max} 60 V DC)
RDC 130 (U_{min} 110 V DC/ U_{max} 130 V DC)
RDC 240 (U_{min} 200 V DC/ U_{max} 240 V DC)
Example: $U_s = 0.7 \times U_{min} - 1.2 \times U_{max} / U_s = 0.7 \times 24 V - 1.2 \times 27 V DC$
- ³⁾ At least smoothed two-phase bridge rectifier or three-phase rectifier

DILM(S)32	DILM38	DILM(S)40	DILM(S)50	DILM(S)65	DILM72	DILM(S)80	DILM(S)95	DILM(S)115	DILM(S)150	DILM170
10.3	10.3	10.3	16.7	25.9	25.9	11.4	16.9	24.2	36.5	48.7
6.6	9.3	6.6	9.9	17.1	21	9	12.6	18.9	32.1	41.1
2.7	2.7	1.9	1.9	1.9	1.9	0.6	0.6	0.6	0.6	0.6
0.8 - 1.1	0.8 - 1.1	0.8 - 1.1	0.8 - 1.1	0.8 - 1.1	0.8 - 1.1	0.8 - 1.1	0.8 - 1.1	0.8 - 1.15	0.8 - 1.15	0.8 - 1.15
0.3 - 0.6	0.3 - 0.6	0.3 - 0.6	0.3 - 0.6	0.3 - 0.6	0.3 - 0.6	0.3 - 0.6	0.3 - 0.6	0.25 - 0.6	0.25 - 0.6	0.25 - 0.6
0.7 - 1.2 ²⁾	0.7 - 1.2 ²⁾	0.7 - 1.2 ²⁾	0.7 - 1.2 ²⁾	0.7 - 1.2 ²⁾	0.7 - 1.2 ²⁾	0.7 - 1.2 ²⁾	0.7 - 1.2 ²⁾	0.7 - 1.2 ²⁾	0.7 - 1.2 ²⁾	0.7 - 1.2 ²⁾
0.15 - 0.6	0.15 - 0.6	0.15 - 0.6	0.15 - 0.6	0.15 - 0.6	0.15 - 0.6	0.15 - 0.6	0.15 - 0.6	0.15 - 0.6	0.15 - 0.6	0.15 - 0.6
52	52	149	149	149	149	310	310	180	180	180
7.1	7.1	16	16	16	16	26	26	3.1	3.1	3.1
2.1	2.1	4.1	4.1	4.1	4.1	5.8	5.8	2.3	2.3	2.3
67	67	178	178	178	178	345	345	170	170	170
8.7	8.7	19	19	19	19	30	30	3.1	3.1	3.1
2.1	2.1	4.1	4.1	4.1	4.1	5.8	5.8	2.3	2.3	2.3
62	62	168	168	168	168	372	372	–	–	–
58	58	154	154	154	154	328	328	–	–	–
9.1	9.1	22	22	22	22	37.1	37.1	–	–	–
6.5	6.5	14	14	14	14	22.6	22.6	–	–	–
2.1	2.1	4.1	4.1	4.1	4.1	5.8	5.8	–	–	–
12	12	24	24	24	24	90	90	149	149	149
0.9	0.9	1	1	1	1	1.5	1.5	1.9	1.9	1.9
100	100	100	100	100	100	100	100	100	100	100
16 - 22	16 - 22	12 - 18	12 - 18	12 - 18	12 - 18	14 - 20	14 - 20	28 - 33	28 - 33	28 - 33
8 - 14	8 - 14	8 - 13	8 - 13	8 - 13	8 - 13	9 - 14	9 - 14	35 - 41	35 - 41	35 - 41
47	47	54	54	54	54	45	45	35	35	35
30	30	24	24	24	24	34	34	30	30	30
10	10	10	10	10	10	15	15	15	15	15
–	–	–	–	–	–	≤ 1	≤ 1	≤ 1	≤ 1	≤ 1

Mechanical lifespan at 50 Hz approx. 30% less than specified on page 1/116 under "Lifespan, mechanical AC operated".

EN 60947-1

EN 60947-1

			DILM(S)7	DILM(S)9	DILM(S)12	DILM15	DILM(S)17	DILM(S)25
Rating data for approved types								
Switching capacity: maximum motor output								
3-phase	200 V, 208 V	HP	1.5	3	3	5	5	7.5
3-phase	230 V, 240 V	HP	2	3	3	5	5	10
3-phase	460 V, 480 V	HP	3	5	10	10	10	15
3-phase	575 V, 600 V	HP	5	7.5	10	10	15	20
1-phase	115 V, 120 V	HP	0.25	0.5	1	1	2	2
1-phase	230 V, 240 V	HP	1	1.5	2	3	3	5
General use		A	20	20	20	20	40	40
Auxiliary contact								
Pilot duty								
AC operated		x	A600	A600	A600	A600	A600	A600
DC operated		x	P300	P300	P300	P300	P300	P300
General Use								
AC		V	600	600	600	600	600	600
AC		A	10	10	10	10	10	10
DC		V	250	250	250	250	250	250
DC		A	1	1	1	1	1	1
Short Circuit Current Rating (SCCR)								
Basic Rating								
SCCR		kA	5	5	5	5	5	5
max. Fuse		A	45	45	45	45	125	125
max. CB		A	60	60	60	60	125	125
480 V High Fault								
SCCR (fuse)		kA	30/100	30/100	30/100	30/100	10/100	10/100
max. Fuse		A	25 Class RK5/20 Class J	25 Class RK5/20 Class J	25 Class RK5/45 Class J	25 Class RK5/60 Class J	125/70 Class J	125/70 Class J
SCCR (CB)		kA	65	65			10/65	10/65
max. CB		A	16	16			50/32	50/32
600 V High Fault								
SCCR (fuse)		kA	30/100	30/100	30/100	30/100	10/100	10/100
max. Fuse		A	25 Class RK5/20 Class J	25 Class RK5/20 Class J	25 Class RK5/45 Class J	25 Class RK5/60 Class J	125/70 Class J	125/100 Class J
SCCR (CB)		kA					10/22	10/22
max. CB		A					50/32	50/32
Special Purpose Ratings								
Electrical Discharge Lamps (Ballast)								
480V 60Hz 3phase, 277V 60Hz 1phase		A	12	18	20	20	40	40
600V 60Hz 3phase, 347V 60Hz 1phase		A	12	18	20	20	40	40
Incandescent Lamps (Tungsten)								
480V 60Hz 3phase, 277V 60Hz 1phase		A	14	14	14	14	40	40
600V 60Hz 3phase, 347V 60Hz 1phase		A	14	14	14	14	40	40
Resistance Air Heating								
480V 60Hz 3phase, 277V 60Hz 1phase		A	12	18	20	20	40	40
600V 60Hz 3phase, 347V 60Hz 1phase		A	12	18	20	20	40	40
Refrigeration Control (CSA only)								
LRA 480V 60Hz 3phase		A	60	60	60	60	240	240
FLA 480V 60Hz 3phase		A	10	10	10	10	40	40
LRA 600V 60Hz 3phase		A	60	60	60	60	180	180
FLA 600V 60Hz 3phase		A	10	10	10	10	30	30
Definite Purpose Ratings (100,000 cycles acc. to UL 1995)								
LRA 480V 60Hz 3phase		A	42	54	72	90	108	150
FLA 480V 60Hz 3phase		A	7	9	12	15	18	25
Elevator Control								
200V 60Hz 3phase		HP	0.75	2	2	2	3	3
200V 60Hz 3phase		A	3.7	7.8	7.8	7.8	11	11
240V 60Hz 3phase		HP	1.5	2	2	3	3	5
240V 60Hz 3phase		A	6	6.8	6.8	9.6	9.6	15.2
480V 60Hz 3phase		HP	2	3	7.5	7.5	7.5	10
480V 60Hz 3phase		A	3.4	4.8	11	11	11	14
600V 60Hz 3phase		HP	3	5	7.5	7.5	10	15
600V 60Hz 3phase		A	3.9	6.1	9	9	11	17

DILM(S)32	DILM38	DILM(S)40	DILM(S)50	DILM(S)65	DILM72	DILM(S)80	DILM(S)95	DILM(S)115	DILM(S)150	DILM170
10	10	10	15	20	20	25	30	40	50	50
10	10	15	20	25	25	30	40	50	60	60
20	20	30	40	50	50	60	75	100	125	125
25	25	40	50	60	60	75	100	100	125	125
2	2	3	3	5	5	7.5	7.5	10	10	10
5	5	7.5	10	15	15	15	15	25	30	30
40	40	63	80	88	88	125	125	180	225	225
A600	A600	A600	A600	A600		A600	A600	A600	A600	-
P300	P300	P300	P300	P300		P300	P300	P300	P300	-
600	600	600	600	600		600	600	600	600	-
10	10	15	15	15		15	15	15	15	-
250	250	250	250	250		250	250	250	250	-
1	1	1	1	1		1	1	1	1	-
5	5	10	10	10	10	10	10	10	10	10
125	125	250	250	250	250	600	600	600	600	600
125	125	250	250	250	250	600	600	600	600	600
10/100	10/100	30/100	30/100	30/100	30/100	30/100	30/100	30/100	30/100	30/100
125/70 Class J	125/70 Class J	250/150 Class J	250/150 Class J	250/150 Class J	250/150 Class J	300/300 Class J	300/300 Class J	300/300 Class J	300/300 Class J	300/300 Class J
10/65	10/65	65	65	65	65	65	65	65	65	65
50/32	50/32	100	100	100	100	250	250	250	250	250
10/100	10/100	30/100	30/100	30/100	30/100	30/100	30/100	30/100	30/100	30/100
125/125 Class J	125/125 Class J	250/150 Class J	250/150 Class J	250/150 Class J	250/150 Class J	300/300 Class J	300/300 Class J	300/300 Class J	300/600 Class J	300/600 Class J
10/22	10/22	30	30	30	30	30	30	30	30	30
50/32	50/32	250	250	250	250	350	350	350	350	350
40	40	79	79	88	88	100	100	160	160	160
40	40	79	79	88	88	100	100	160	160	160
40	40	74	74	88	88	100	100	160	160	160
40	40	74	74	88	88	100	100	160	160	160
40	40	79	79	88	88	100	100	160	160	160
40	40	79	79	88	88	100	100	160	160	160
240	240	-	-	-	-	540	540	540	540	540
40	40	-	-	-	-	90	90	84	90	90
180	180	-	-	-	-	420	420	540	540	540
30	30	-	-	-	-	70	70	84	90	90
192	192	-	-	390	432	480	570	690	900	1020
32	32	-	-	65	72	80	95	115	150	170
7.5	7.5	7.5	10	10	10	20	20	30	30	30
25.3	25.3	25.3	32.2	32.2	32.2	62.1	62.1	92	92	92
7.5	7.5	10	15	15	15	25	30	40	40	40
22	22	28	42	42	42	68	80	104	104	104
20	20	25	30	30	30	50	60	75	75	75
27	27	34	40	40	40	65	77	96	96	96
20	20	30	40	40	40	60	75	100	100	100
22	22	32	41	41	41	62	77	99	99	99

			DILM185A	DILM225A	DILM250	DILM300A	DILM400	DILM500
General								
Standards	IEC/EN 60947, VDE 0660, UL, CSA							
Lifespan, mechanical								
AC operated	Operations	x 10 ⁶	10	10	10	10	7	7
DC operated	Operations	x 10 ⁶	10	10	10	10	7	7
Operating frequency, mechanical								
AC operated	Operations/h		3000	3000	3000	3000	2000	2000
DC operated	Operations/h		3000	3000	3000	3000	2000	2000
Maximum operating frequency								
electrical (Contactor without overload relay)	→ Page 1/101							
Climatic proofing								
Damp heat, constant, to IEC 60068-2-78								
Damp heat, cyclic, to IEC 60068-2-30								
Ambient temperature								
Open	°C		-40 - 60 ¹⁾	-40 - 60 ¹⁾	-40 - 60	-40 - 60	-40 - 60	-40 - 60
Enclosed	°C		-40 - 40 ²⁾	-40 - 40 ²⁾	-40 - 40	-40 - 40	-40 - 40	-40 - 40
Storage	°C		-40 - 80	-40 - 80	-40 - 80	-40 - 80	-40 - 80	-40 - 80
Mounting position: AC and DC operated								
Mechanical shock resistance (IEC/EN 60068-2-27), half-sinusoidal shock 10 ms								
Main contacts								
N/O	g		10	10	10	10	10	10
Auxiliary contacts								
N/O	g		10	10	10	10	10	10
N/C	g		8	8	8	8	8	8
Protection rating								
			IP00	IP00	IP00	IP00	IP00	IP00
Busbar tag shroud when actuated from front (EN 50274)								
Finger- and back-of-hand proof with cover or terminal block								
Weight								
Weight	kg		3.5	3.5	7.2	7.1	8.6	8.6
Terminal capacities, main cable (Cu cable)								
Flexible with cable lug	mm ²		50 - 185	50 - 185	50 - 240	50 - 240	50 - 240	50 - 240
Stranded with cable lug	mm ²		50 - 185	70 - 185	70 - 240	70 - 240	70 - 240	70 - 240
Solid or stranded	AWG		1/0 - 350 MCM	2/0 - 250 MCM	2/0 - 500 MCM	2/0 - 500 MCM	2/0 - 500 MCM	2/0 - 500 MCM
Fixing with flat cable terminals or cable terminal block, see terminal capacity for cable terminal blocks								
busbar	Width	mm	32	32	25	25	25	30
Main cable connection screw/bolt								
			M10	M10	M10	M10	M10	M10
Tightening torque								
			Nm	24	24	24	24	24
Terminal capacities, control circuit cable (Cu cable)								
Solid	mm ²		1 x (0.75 - 2.5) 2 x (0.75 - 2.5)	1 x (0.75 - 2.5) 2 x (0.75 - 2.5)	1 x (0.75 - 2.5) 2 x (0.75 - 2.5)	1 x (0.75 - 2.5) 2 x (0.75 - 2.5)	1 x (0.75 - 2.5) 2 x (0.75 - 2.5)	1 x (0.75 - 2.5) 2 x (0.75 - 2.5)
flexible with ferrule	mm ²		1 x (0.75 - 2.5) 2 x (0.75 - 2.5)	1 x (0.75 - 2.5) 2 x (0.75 - 2.5)	1 x (0.75 - 2.5) 2 x (0.75 - 2.5)	1 x (0.75 - 2.5) 2 x (0.75 - 2.5)	1 x (0.75 - 2.5) 2 x (0.75 - 2.5)	1 x (0.75 - 2.5) 2 x (0.75 - 2.5)
Solid or stranded	AWG		18 - 14	18 - 14	18 - 14	18 - 14	18 - 14	18 - 14
Stripping length								
			mm	10	10	10	10	10
Control circuit cable connection screw/bolt								
			M3.5	M3.5	M3.5	M3.5	M3.5	M3.5
Tightening torque								
			Nm	1.2	1.2	1.2	1.2	1.2
Tool								
Main conductors								
Width across flats	mm		16	16	16	16	16	16
Control circuit cable								
Pozidriv screwdriver	Size		2	2	2	2	2	2
Notes								
¹⁾ For ...(RAC440) and ...(RAC500): -25 - 60 °C								
²⁾ For ...(RAC440) and ...(RAC500): -25 - 40 °C								

DILM580	DILM650	DILM750	DILM820	DILM1000	DILM1600	DILH1200	DILH1400	DILH2000	DILH2200	DILH2600
IEC/EN 60947, VDE 0660, UL, CSA						IEC/EN 60947, VDE 0660, UL, CSA, CCC				
5	5	5	5	5	5	3	5	5	5	5
5	5	5	5	5	5	3	5	5	5	5
1000	1000	1000	1000	1000	1000	1000	1000	1000	1000	1000
1000	1000	1000	1000	1000	1000	1000	1000	1000	1000	1000
→ Page 1/101										
Damp heat, constant, to IEC 60068-2-78										
Damp heat, cyclic, to IEC 60068-2-30										
-40 - 60	-40 - 60	-40 - 60	-40 - 60	-40 - 60	-40 - 60	-40 - 60	-40 - 60	-40 - 60	-40 - 60	-40 - 60
-40 - 40	-40 - 40	-40 - 40	-40 - 40	-40 - 40	-40 - 40	-40 - 40	-40 - 40	-40 - 40	-40 - 40	-40 - 40
-40 - 80	-40 - 80	-40 - 80	-40 - 80	-40 - 80	-40 - 80	-40 - 80	-40 - 80	-40 - 80	-40 - 80	-40 - 80
10	10	10	10	10	10	10	10	10	10	10
10	10	10	10	10	10	10	10	10	10	10
8	8	8	8	8	8	8	8	8	8	8
IP00	IP00	IP00	IP00	IP00	IP00	IP00	IP00	IP00	IP00	IP00
Finger- and back-of-hand proof with cover or terminal block						-	-	-	-	-
16.2	16.2	16.5	16.5	17.3	32	14.4	14.4	32	32	35.2
50 - 240	50 - 240	50 - 240	50 - 240	50 - 240	-	-	-	-	-	-
70 - 240	70 - 240	70 - 240	70 - 240	70 - 240	-	-	-	-	-	-
2/0 - 500 MCM	2/0 - 500 MCM	2/0 - 500 MCM	2/0 - 500 MCM	2/0 - 500 MCM	-	-	-	-	-	-
50	50	60	60	60	100	80	80	100	100	100
M10	M10	M12	M12	M12	M12	M12	M12	M12	M12	M12
24	24	35	35	35	35	35	35	35	35	35
1 x (0.75 - 2.5)										
2 x (0.75 - 2.5)										
1 x (0.75 - 2.5)										
2 x (0.75 - 2.5)										
18 - 14	18 - 14	18 - 14	18 - 14	18 - 14	18 - 14	18 - 14	18 - 14	18 - 14	18 - 14	18 - 14
10	10	10	10	101	10	10	10	10	10	10
M3.5	M3.5	M3.5	M3.5	M3.5	M3.5	M3.5	M3.5	M3.5	M3.5	M3.5
1.2	1.2	1.2	1.2	1.2	1.2	1.2	1.2	1.2	1.2	1.2
16	16	18	18	18	18	18	18	18	18	18
2	2	2	2	2	2	2	2	2	2	2

			DILM185A	DILM225A	DILM250	DILM300A	DILM400	DILM500	
Main circuits									
Rated impulse withstand voltage	U_{imp}	V AC	8000	8000	8000	8000	8000	8000	
Overvoltage category/degree of pollution			III/3	III/3	III/3	III/3	III/3	III/3	
Rated insulation voltage	U_i	V AC	1000	1000	1000	1000	1000	1000	
Rated operating voltage	U_e	V AC	1000	1000	1000	1000	1000	1000	
Safe isolation according to EN 61140									
	between coil and contacts	V AC	500	500	500	500	500	500	
	between the contacts	V AC	500	500	500	500	500	500	
Making capacity (cos φ to IEC/EN 60947)		A	2700	2700	3000	3600	5500	5500	
Breaking Capacity									
	220/230 V	A	2250	2250	2500	3000	5000	5000	
	380/400 V	A	2250	2250	2500	3000	5000	5000	
	500 V	A	2250	2250	2500	3000	5000	5000	
	660/690 V	A	2250	2250	2500	3000	5000	5000	
	1000 V	A	760	760	760	950	950	950	
Component lifespan			→ Page 1/97						
Short-circuit rating									
Short-circuit protection max. Fuse									
Type of coordination "2"									
	400 V	gG/gL 500 V	A	315	315	315	315	500	500
	690 V	gG/gL 690 V	A	250	250	315	315	500	500
	1000 V	gG/gL 1000 V	A	160	160	160	160	200	200
Type of coordination "1"									
	400 V	gG/gL 500 V	A	400	400	400	400	630	630
	690 V	gG/gL 690 V	A	315	315	400	400	630	630
	1000 V	gG/gL 1000 V	A	200	200	200	200	250	250
Alternating voltage									
AC-1 operation									
Conventional thermal current, 3-pole, 50 - 60 Hz									
Open									
	at 40 °C	$I_{th} = I_e$	A	337	386	430	490	612	800
	at 50 °C	$I_{th} = I_e$	A	301	345	380	438	548	715
	at 55 °C	$I_{th} = I_e$	A	287	329	365	418	522	682
	at 60 °C	$I_{th} = I_e$	A	275	315	350	400	500	650
	enclosed ¹⁾	$I_{th} = I_e$	A	245	275	300	315	450	600
Conventional thermal current 1-pole									
	Open ¹⁾	$I_{th} = I_e$	A	685	707	825	875	1250	1625
	enclosed ¹⁾	$I_{th} = I_e$	A	625	636	742	785	1125	1500
AC-3 operation									
Rated operational current AC-3 open, 3-pole, 50 - 60 Hz									
	220/230 V	I_e	A	185	225	250	300	400	500
	240 V	I_e	A	185	225	250	300	400	500
	380/400 V	I_e	A	185	225	250	300	400	500
	415 V	I_e	A	185	225	250	300	400	500
	440 V	I_e	A	185	225	250	300	400	500
	500 V	I_e	A	185	225	250	300	400	500
	660/690 V	I_e	A	150	160	185	185	325	325
	1000 V	I_e	A	76	76	76	95	95	95
Motor rating									
	220/230 V	P	kW	55	70	75	90	125	155
	240 V	P	kW	62	75	85	100	132	170
	380/400 V	P	kW	90	110	132	160	212	265
	415 V	P	kW	110	132	143	175	232	290
	440 V	P	kW	115	138	152	185	250	315
	500 V	P	kW	132	160	173	210	280	355
	660/690 V	P	kW	140	150	170	170	300	300
	1000 V	P	kW	108	108	108	132	132	132

Notes¹⁾ At maximum permissible ambient air temperature²⁾ Up to 690 V

DILM580	DILM650	DILM750	DILM820	DILM1000	DILM1600	DILH1200	DILH1400	DILH2000	DILH2200	DILH2600
8000	8000	8000	8000	8000	8000	8000	8000	8000	8000	8000
III/3	III/3	III/3	III/3	III/3	III/3	III/3	III/3	III/3	III/3	III/3
1000	1000	1000	1000	1000	1000	1000	1000	1000	1000	1000
1000	1000	1000	1000	1000	1000	1000	1000	1000	1000	1000
500	500	500	500	500	500	500	500	500	500	500
500	500	500	500	500	500	500	500	500	500	500
7800	7800	9840	9840	9840	19000	9840	9840	9840	9840	9840
6500	6500	8200	8200	8200	16000	8200	8200	8200	8200	8200
6500	6500	8200	8200	8200	16000	8200	8200	8200	8200	8200
6500	6500	8200	8200	8200	16000	8200	8200	8200	8200	8200
6500	6500	8200	8200	8200	16000	8200	8200	8200	8200	8200
4350	4350	5800	5800	5800	5800	5800	5800	5800	5800	5800
→ Page 1/97										
630	630	630	630	630	-	-	-	-	-	-
630	630	630	630	630	-	-	-	-	-	-
500	500	630	630	630	-	-	-	-	-	-
1000	1000	1200	1200	1200	-	-	-	-	-	-
1000	1000	1200	1200	1200	-	-	-	-	-	-
630	630	800	800	800	-	-	-	-	-	-
980	1041	1102	1225	1225	2200 ²⁾	1450	1714 ²⁾	2450 ²⁾	2700 ²⁾	3185 ²⁾
876	931	986	1095	1095	1970 ²⁾	1315	1533 ²⁾	2190 ²⁾	2400 ²⁾	2847 ²⁾
836	888	940	1044	1044	1880 ²⁾	1250	1462 ²⁾	2089 ²⁾	2300 ²⁾	2716 ²⁾
800	850	900	1000	1000	1800 ²⁾	1200	1400 ²⁾	2000 ²⁾	2200 ²⁾	2600 ²⁾
-	-	-	-	-	-	-	-	-	-	-
2000	2125	2250	2500	2500	4500	3000	3500	5000	5500	6500 ²⁾
-	-	-	-	-	-	-	-	-	-	-
580	650	750	820	1000	1600	-	-	-	-	-
580	650	750	820	1000	1600	-	-	-	-	-
580	650	750	820	1000	1600	-	-	-	-	-
580	650	750	820	1000	1600	-	-	-	-	-
580	650	750	820	1000	1600	-	-	-	-	-
580	650	750	820	1000	1600	-	-	-	-	-
580	650	750	820	1000	1600	-	-	-	-	-
435	435	580	580	750	1200	-	-	-	-	-
185	205	240	260	315	500	-	-	-	-	-
200	225	260	285	340	550	-	-	-	-	-
315	355	400	450	560	900	-	-	-	-	-
348	390	455	500	610	930	-	-	-	-	-
370	420	480	450	650	1000	-	-	-	-	-
420	470	550	600	730	1180	-	-	-	-	-
560	630	720	750	1000	1600	-	-	-	-	-
600	600	800	800	1100	1770	-	-	-	-	-

			DILM185A	DILM225A	DILM250	DILM300A	DILM400	DILM500
Alternating voltage								
AC-4 operation								
Rated operational current AC-4 open, 3-pole, 50 - 60 Hz								
220/230 V	I_e	A	136	164	200	240	296	360
240 V	I_e	A	136	164	200	240	296	360
380/400 V	I_e	A	136	164	200	240	296	360
415 V	I_e	A	136	164	200	240	296	360
440 V	I_e	A	136	164	200	240	296	360
500 V	I_e	A	136	164	200	240	296	360
660/690 V	I_e	A	110	120	150	150	260	260
1000 V	I_e	A	55	55	76	76	95	95
Motor rating								
220/230 V	P	kW	41	51	62	75	92	112
240 V	P	kW	45	54	68	82	100	122
380/400 V	P	kW	75	90	110	132	160	200
415 V	P	kW	80	96	117	142	176	216
440 V	P	kW	85	102	125	150	186	229
500 V	P	kW	96	116	138	170	210	250
660/690 V	P	kW	102	110	137	137	240	240
1000 V	P	kW	77	77	108	108	132	132
Capacitor Operation								
Individual compensation rated operational current I_e of alternating current capacitors								
Open								
up to 525 V		A	220	220	220	307	307	307
690 V		A	133	133	133	177	177	177
Max. Inrush current peak		x I_e	30	30	30	30	30	30
Component lifespan	Operations	x 10^6	0.1	0.1	0.1	0.1	0.1	0.1
max. operating frequency		ops./h	200	200	200	200	200	200
DC Voltage								
DC1 rated operational current I_e open			see DILDC300/DILDC600 or on request					
Current heat loss (3 pole)								
Current heat loss at I_{th} (60 °C)		W	34	45	55	37	58	113
Current heat loss at I_e to AC-3/400 V		W	16	23	28	21	37	58

DILM580	DILM650	DILM750	DILM820	DILM1000	DILM1600	DILH1200	DILH1400	DILH2000	DILH2200	DILH2600
456	512	576	656	800	1280	–	–	–	–	–
456	512	576	656	800	1280	–	–	–	–	–
456	512	576	656	800	1280	–	–	–	–	–
456	512	576	656	800	1280	–	–	–	–	–
456	512	576	656	800	1280	–	–	–	–	–
456	512	576	656	800	1280	–	–	–	–	–
456	512	576	656	800	1280	–	–	–	–	–
348	348	464	464	700	1120	–	–	–	–	–
143	161	181	209	260	430	–	–	–	–	–
156	176	200	228	280	450	–	–	–	–	–
250	280	315	355	450	750	–	–	–	–	–
274	307	346	394	490	770	–	–	–	–	–
290	326	367	418	520	830	–	–	–	–	–
330	370	417	474	590	940	–	–	–	–	–
440	494	556	633	780	1300	–	–	–	–	–
509	509	678	678	1000	1650	–	–	–	–	–
463	463	463	463	463	–	–	–	–	–	–
265	265	265	265	265	–	–	–	–	–	–
30	30	30	30	30	–	–	–	–	–	–
0.1	0.1	0.1	0.1	0.1	–	–	–	–	–	–
200	200	200	200	200	–	–	–	–	–	–
–	–	–	–	–	–	–	–	–	–	–
61	69	78	96	96	155	135	189	192	231	249
32	41	54	65	96	123	–	–	–	–	–

			DILM185A	DILM225A	DILM250	DILM300A	DILM400	DILM500
Magnet systems								
Voltage tolerance								
Comfort device								
AC operated	Pick-up		$0.8 \times U_{S \min} - 1.15 \times U_{S \max}$		$0.7 \times U_{S \min} - 1.15 \times U_{S \max}$			
DC operated	Pick-up		$0.7 \times U_{S \min} - 1.2 \times U_{S \max}$		$0.7 \times U_{S \min} - 1.15 \times U_{S \max}$			
AC operated	Drop-out		$0.25 \times U_{S \min} - 0.6 \times U_{S \max}$		$0.2 \times U_{S \max} - 0.6 \times U_{S \min}$			
DC operated	Drop-out		$0.15 \times U_{S \min} - 0.6 \times U_{S \max}$		$0.2 \times U_{S \max} - 0.6 \times U_{S \min}$			
Standard devices								
AC operated	Pick-up		–	–	$0.85 \times U_{S \min} - 1.1 \times U_{S \max}$			
AC operated	Drop-out		–	–	$0.2 \times U_{S \max} - 0.4 \times U_{S \min}$			
Power consumption of the coil in a cold state and $1.0 \times U_c$								
Comfort device								
Note on power consumption			–	–	Control transformer with $u_k \leq 6\%$			
Pick-up power	Pick-up	VA	210	210	380	380	450	450
	Pick-up	W	180	180	250	250	350	350
Standard devices								
Note on power consumption			–	–	Control transformer with $u_k \leq 10\%$			
Pick-up power	Pick-up	VA	–	–	360	360	715	715
	Pick-up	W	–	–	325	325	645	645
Sealing power with voltage...								
Comfort device								
AC operated								
RAC...	Hold	VA/W	2.6/2.1	2.6/2.1	–	–	–	–
DC operated								
RDC...	Hold	VA/W	-/2.1	-/2.1	-/4.6	-/4.6	-/6.4	-/6.4
AC/DC operated								
RA110	Hold	VA/W	–	–	9.2/4.3	9.2/4.3	12.1/6.3	12.1/6.3
RA250	Hold	VA/W	–	–	10.5/5.5	10.5/5.5	14.2/7.9	14.2/7.9
RAC500	Hold	VA/W	–	–	17.7/10.8	17.7/10.8	19.6/11.7	19.6/11.7
RAW250	Hold	VA/W	–	–	–	–	–	–
Standard devices								
AC operated								
110 - 120 V	Hold	VA/W	–	–	6.7/4.2	6.7/4.2	7.3/4.6	7.3/4.6
220 - 240 V	Hold	VA/W	–	–	7.3/4.8	7.3/4.8	6.8/4	6.8/4
Duty factor								
	% ED		100	100	100	100	100	100
Changeover time at 100% U_S (recommended values), main contacts								
Comfort device								
Closing time	ms		< 60	< 60	< 100	< 100	< 80	< 80
Opening time	ms		< 40	< 40	< 110	< 110	< 110	< 110
Standard devices								
Closing time	ms		–	–	< 55	< 55	< 55	< 55
Opening time	ms		–	–	< 40	< 40	< 50	< 50
Behavior in limit range and transition area, hold state								
Voltage interruption								
$(0 - 0.2) \times U_{S \min} \leq 10$ ms			–	–	Targeted bridging during this time			
$(0 - 0.2) \times U_{S \min} > 10$ ms			–	–	Drop-out of the contactors			
Voltage drops								
$(0.2 - 0.6) \times U_{S \min} \leq 12$ ms			–	–	Targeted bridging during this time			
$(0.2 - 0.6) \times U_{S \min} > 12$ ms			–	–	Drop-out of the contactors			
$(0.6 - 0.7) \times U_{S \min}$			–	–	Contactor remains switched on			
Excess voltage								
$(1.15 - 1.3) \times U_{S \max}$			–	–	Contactor remains switched on			
Pick-up phase								
$(0 - 0.7) \times U_{S \min}$			–	–	Contactor does not switch on			
$0.7 \times U_{S \min} - 1.15 \times U_{S \max}$			–	–	Contactor switches on safely			
Permissible transitional contact resistance (of external control unit when A11 is actuated)								
	mΩ		–	–	≤ 500	≤ 500	≤ 500	≤ 500
Permissible residual current (when A11 is actuated from the electronic system in the event of a 0 signal)								
	mA		–	–	≤ 1	≤ 1	≤ 1	≤ 1
PLC signal level (A3 - A4) to IEC/EN 61131-2 (type 2) ¹⁾								
High	V		–	–	15	15	15	15
Low	V		–	–	5	5	5	5

Electromagnetic compatibility (EMC)

Electromagnetic compatibility

This product is designed for operation in industrial environments (environment A). The use in residential environments (environment B) could cause electrical interference so that additional suppression must be planned.

Notes¹⁾ Only comfort devices²⁾ Only for RA110, RA250, RAC500

DILM580	DILM650	DILM750	DILM820	DILM1000	DILM1600	DILH1200	DILH1400	DILH2000	DILH2200	DILH2600
$0.7 \times U_{S \min} - 1.15 \times U_{S \max}$										
$0.7 \times U_{S \min} - 1.15 \times U_{S \max}$										
$0.2 \times U_{S \max} - 0.6 \times U_{S \min}$										
$0.2 \times U_{S \max} - 0.6 \times U_{S \min}$										
-	-	-	-	-	-	-	-	-	-	-
-	-	-	-	-	-	-	-	-	-	-
Control transformer with $u_k \leq 7\%$										
800	800	800	800	800	1600	800	800	1600	1600	1600
700	700	700	700	700	1400	700	700	1400	1400	1400
-	-	-	-	-	-	-	-	-	-	-
-	-	-	-	-	-	-	-	-	-	-
-	-	-	-	-	-	-	-	-	-	-
-	-	-	-	-	-	-	-	-	-	-
26.4/10.3	26.4/10.3	26.4/10.3	26.4/10.3	-	-	-	26.4/10.3	-	-	-
26.5/11.4	26.5/11.4	26.5/11.4	26.5/11.4	26.5/11.4	-	-	26.5/11.4	-	-	-
28.8/12.4	28.8/12.4	28.8/12.4	28.8/12.4	28.8/12.4	-	-	28.8/12.4	-	-	-
-	-	-	-	-	36.5/17.3	26.5/11.4	26.5/11.4	36.5/17.3	36.5/17.3	36.5/17.3
-	-	-	-	-	-	-	-	-	-	-
-	-	-	-	-	-	-	-	-	-	-
100	100	100	100	100	100	100	100	100	100	100
< 70	< 70	< 70	< 70	< 70	< 70	< 70	< 70	< 70	< 70	< 70
< 110	< 110	< 110	< 110	< 110	< 40	< 40	< 40/< 110 ²⁾	< 40	< 40	< 40
-	-	-	-	-	-	-	-	-	-	-
-	-	-	-	-	-	-	-	-	-	-
Targeted bridging during this time						Targeted bridging during this time				
Drop-out of the contactors						Drop-out of the contactors				
Targeted bridging during this time						Targeted bridging during this time				
Drop-out of the contactors						Drop-out of the contactors				
Contactor remains switched on						Contactor remains switched on				
Contactor remains switched on						Contactor remains switched on				
Contactor does not switch on						Contactor does not switch on				
Contactor switches on safely						Contactor switches on safely				
≤ 500	≤ 500	≤ 500	≤ 500	≤ 500	≤ 500	≤ 500	≤ 500	≤ 500	≤ 500	≤ 500
≤ 1	≤ 1	≤ 1	≤ 1	≤ 1	≤ 1	≤ 1	≤ 1	≤ 1	≤ 1	≤ 1
15	15	15	15	15	15	15	15	15	15	15
5	5	5	5	5	5	5	5	5	5	5

This product is designed for operation in industrial environments (environment A). The use in residential environments (environment B) could cause electrical interference so that additional suppression must be planned.

		DILM185A	DILM225A	DILM250	DILM300A	DILM400	DILM500
Rating data for approved types							
Switching capacity							
Maximum motor rating							
3-phase							
200 V, 208 V	HP	50	60	75	100	125	150
230 V/240 V	HP	60	75	100	125	150	200
460 V, 480 V	HP	125	150	200	250	300	400
575 V, 600 V	HP	150	200	250	300	400	500
General use	A	250	250	350	350	450	550
Auxiliary contact							
Pilot duty							
AC operated		A600	A600	A600	A600	A600	A600
DC operated		P300	P300	P300	P300	P300	P300
General Use							
AC	V	600	600	600	600	600	600
AC	A	15	15	15	15	15	15
DC	V	250	250	250	250	250	250
DC	A	1	1	1	1	1	1
Short Circuit Current Rating (SCCR)							
Basic Rating							
SCCR	kA	10	10	18	18	30	30
max. Fuse	A	700	700	700	700	800	800
max. CB	A	800	600	600	600	600	600
480 V High Fault							
SCCR (fuse)	kA	100	100	18	18	30/100	30/100
max. Fuse	A	600 Class J	600 Class J	700 Class L	700 Class L	800/600 Class J	800/600 Class J
SCCR (CB)	kA	65	65	65	65	100	100
max. CB	A	350	350	250	250	600	600
600 V High Fault							
SCCR (fuse)	kA	100	100	18	18	30/100	30/100
max. Fuse	A	600 Class J	600 Class J	700 Class J	700 Class J	800/600 Class J	800/600 Class J
SCCR (CB)	kA	50	50	18	18	30	30
max. CB	A	350	350	600	600	600	600
Special Purpose Ratings							
Resistance Air Heating							
480V 60Hz 3phase, 277V 60Hz 1phase	A	–	–	–	–	–	–
600V 60Hz 3phase, 347V 60Hz 1phase	A	–	–	–	–	–	–
Refrigeration Control (CSA only)	A	–	–	–	–	–	–
Definite Purpose Ratings (100,000 cycles acc. to UL 1995)							
LRA 480V 60Hz 3phase	A	2016	2016	2050	2160	3300	3900
FLA 480V 60Hz 3phase	A	336	336	300	360	550	635
LRA 600V 60Hz 3phase	A	1680	1680	1800	1800	3120	3120
FLA 600V 60Hz 3phase	A	280	280	250	300	420	520

DILM580	DILM650	DILM750	DILM820	DILM1000	DILM1600	DILH1200	DILH1400	DILH2000	DILH2200	DILH2600
200	200	250	290	–	560	–	–	–	–	–
200	250	300	350	400	640	–	–	–	–	–
400	500	600	700	800	1200	–	–	–	–	–
600	600	700	860	1000	1300	–	–	–	–	–
980	1041	1102	1225	1225	1600	1380	1600	2000	2200	2600
A600	A600	A600	A600	A600	A600	A600	A600	A600	A600	A600
P300	P300	P300	P300	P300	P300	P300	P300	P300	P300	P300
600	600	600	600	600	600	600	600	600	600	600
15	15	15	15	15	15	15	15	15	15	15
250	250	250	250	250	250	250	250	250	250	250
1	1	1	1	1	1	1	1	1	1	1
30	30	42	42	85	85	–	–	–	–	–
2000	2000	2000	2000	2000	2000	–	–	–	–	–
1200	1200	1200	1200	1200	–	–	–	–	–	–
85	85	85	85	85	85	–	–	–	–	–
2000	2000	2000	2000	2000	2000	–	–	–	–	–
85	85	85	85	85	–	–	–	–	–	–
1200	1200	1200	1200	1200	–	–	–	–	–	–
85	85	85	85	85	85	–	–	–	–	–
2000	2000	2000	2000	2000	2000	–	–	–	–	–
85	85	85	85	85	–	–	–	–	–	–
1200	1200	1200	1200	1200	–	–	–	–	–	–
–	–	–	–	–	–	1380	1400	2000	2200	2600
–	–	–	–	–	–	1380	1400	2000	2200	2600
–	–	–	–	–	–	–	–	–	–	–
4020	4350	4800	5400	6000	–	–	–	–	–	–
670	725	800	900	1200	–	–	–	–	–	–
4020	4350	4800	5400	6000	–	–	–	–	–	–
670	725	800	900	1200	–	–	–	–	–	–

		DILMP20	DILMP32 DILMP45	DILMP63 DILMP80	DILMP125 DILMP160 DILMP200
General					
Standards		IEC/EN 60947, VDE 0660, UL, CSA			
Lifespan, mechanical					
AC operated	Operations	x 10 ⁶ 10	10	10	10
DC operated	Operations	x 10 ⁶ 10	10	10	10
Operating frequency, mechanical					
AC operated	Operations/h	5000	5000	5000	3600
DC operated	Operations/h	5000	5000	5000	3600
max. Electrical switching frequency (contactors without overload relay)		600	600	600	600
Climatic proofing		Damp heat, constant, to IEC 60068-2-3; Damp heat, cyclic, to IEC 60068-2-30			
Ambient temperature					
Open	°C	-25 - 60	-25 - 60	-25 - 60	-25 - 60
Enclosed	°C	-25 - 40	-25 - 40	-25 - 40	-25 - 40
Storage	°C	-40 - 80	-40 - 80	-40 - 80	-40 - 80
Mounting position AC- and DC operated					
Mechanical shock resistance (IEC/EN 60068-2-27), half-sinusoidal shock 10 ms					
Main contacts					
N/O	g	10	10	10	10
Auxiliary contacts					
N/O	g	7	7	7	7
N/C	g	5	5	5	5
Protection rating		IP20	IP00	IP00	IP00
with accessories		–	IP20	IP20	IP20
Busbar tag shroud when actuated from front (EN 50274)		Finger- and back-of-hand proof			
Terminal type, screw connection					
Terminal capacities, main cable (Cu cable)					
Solid	mm ²	1 x (0.75 - 4) 2 x (0.75 - 2.5)	1 x (0.75 - 16) 2 x (0.75 - 10)	1 x (2.5 - 16) 2 x (2.5 - 16)	–
flexible with ferrule	mm ²	1 x (0.75 - 2.5) 2 x (0.75 - 2.5)	1 x (0.75 - 16) 2 x (0.75 - 10)	1 x (2.5 - 35) 2 x (2.5 - 25)	1 x (10 - 95) 2 x (10 - 70)
Stranded	mm ²	–	1 x 16	1 x (16 - 50) 2 x (16 - 35)	1 x (16 - 120) 2 x (16 - 95)
Solid or stranded	AWG	18 - 14	18 - 6	12 - 2	8 - 3/0
Flat conductor	Number of segments x width x thickness	mm	–	2 x (6 x 9 x 0.8)	2 x (6 x 16 x 0.8)
Stripping length	mm	10	10	10	15
Terminal Screw		M3.5	M5	M6	M10
Tightening torque	Nm	1.2	3	3.3	14
Terminal capacities, control circuit cable (Cu cable)					
Solid	mm ²	1 x (0.75 - 4) 2 x (0.75 - 2.5)	1 x (0.75 - 4) 2 x (0.75 - 2.5)	1 x (0.75 - 4) 2 x (0.75 - 4)	1 x (0.75 - 4) 2 x (0.75 - 4)
flexible with ferrule	mm ²	1 x (0.75 - 2.5) 2 x (0.75 - 2.5)	1 x (0.75 - 2.5) 2 x (0.75 - 2.5)	1 x (0.75 - 2.5) 2 x (0.75 - 2.5)	1 x (0.75 - 2.5) 2 x (0.75 - 2.5)
Solid or stranded	AWG	18 - 14	18 - 14	18 - 14	18 - 14
Stripping length	mm	10	10	10	10
Terminal Screw		M3.5	M3.5	M3.5	M3.5
Tightening torque	Nm	1.2	1.2	1.2	1.2
Tool					
Main conductors					
Pozidriv screwdriver	Size	2	2	2	–
Standard screwdriver	mm	0.8 x 5.5 (1 x 6)	0.8 x 5.5 (1 x 6)	0.8 x 5.5 (1 x 6)	–
Hexagon socket-head screw	SW	mm	–	–	5
Control circuit cable					
Pozidriv screwdriver	Size	2	2	2	2
Standard screwdriver	mm	0.8 x 5.5 (1 x 6)	0.8 x 5.5 (1 x 6)	0.8 x 5.5 (1 x 6)	0.8 x 5.5 (1 x 6)

			DILMP20	DILMP32 DILMP45	DILMP63 DILMP80	DILMP125 DILMP160 DILMP200				
Main circuits										
Rated impulse withstand voltage	U_{imp}	V AC	8000							
Overvoltage category/degree of pollution			III/3							
Rated insulation voltage	U_i	V AC	690							
Rated operating voltage	U_e	V AC	690							
Safe isolation according to EN 61140										
between coil and contacts		V AC	400	440						
between the contacts		V AC	400	440						
Making capacity (cos ϕ to IEC/EN 60947)	Up to 690 V	A	144	238	350	560	700	1120	1330	1800
Breaking Capacity										
220/230 V		A	120	180	250	400	500	800	950	1150
380/400 V		A	120	180	250	400	500	800	950	1150
500 V		A	100	180	250	400	500	800	950	1150
660/690 V		A	70	120	144	250	296	650	750	800
Short-circuit rating										
Short-circuit protection max. Fuse										
Type of coordination "2"										
400 V	gG/gL 500 V	A	20	35	35	63	80	160	160	250
690 V	gG/gL 690 V	A	20	35	35	50	63	160	160	200
Type of coordination "1"										
400 V	gG/gL 500 V	A	35	63	100	125	160	250	250	250
690 V	gG/gL 690 V	A	25	50	50	80	80	200	200	200
Alternating voltage										
AC-1 operation										
Conventional thermal current, 3-pole, 50 - 60 Hz										
Open										
at 40 °C	$I_{th} = I_e$	A	22	32	45	63	80	125	160	200
at 50 °C	$I_{th} = I_e$	A	21	30	41	60	76	116	150	188
at 55 °C	$I_{th} = I_e$	A	20.5	29	40	58	73	110	143	180
at 60 °C	$I_{th} = I_e$	A	20	28	39	54	69	108	138	172
Enclosed	$I_{th} = I_e$	A	18	27	36	50	64	100	128	160
Conventional thermal current 1-pole										
Open	$I_{th} = I_e$	A	60	84	117	162	207	325	415	516
Enclosed	$I_{th} = I_e$	A	54	76	105	146	186	292	373	464
Motor rating										
220/230 V	P	kW	8	12	16	23	29	45	58	72
240 V	P	kW	9	13	18	25	32	49	63	79
380/400 V	P	kW	14	20	28	39	50	78	100	125
415 V	P	kW	15	22	31	43	55	85	109	137
440 V	P	kW	16	23	33	46	58	90	116	145
500 V	P	kW	18	26	37	52	66	103	132	165
690 V	P	kW	24	35	49	68	87	136	174	217
AC-3 operation										
Rated operational current AC-3 open, 3-pole, 50 - 60 Hz										
220/230 V	I_e	A	12	18	25	40	50	80	95	115
240 V	I_e	A	12	18	25	40	50	80	95	115
380/400 V	I_e	A	12	18	25	40	50	80	95	115
415 V	I_e	A	12	18	25	40	50	80	95	115
440 V	I_e	A	12	18	25	40	50	80	95	115
500 V	I_e	A	10	18	25	40	50	80	95	115
660/690 V	I_e	A	7	12	15	25	32	65	80	93
Motor rating										
220/230 V	P	kW	3.5	5	7.5	12.5	15.5	25	30	37
240 V	P	kW	4	5.5	8.5	13.5	17	27.5	33	40
380/400 V	P	kW	5.5	7.5	11	18.5	22	37	45	55
415 V	P	kW	7	10	14.5	24	30	48	57	70
440 V	P	kW	7.5	10.5	15.5	25	32	51	60	75
500 V	P	kW	7	12	17.5	28	36	58	70	85
660/690 V	P	kW	6.5	11	14	23	30	63	75	90

				DILMP20	DILMP32 DILMP45	DILMP63 DILMP80	DILMP125 DILMP160 DILMP200				
DC Voltage											
Rated operational current I_e open											
DC-1-operation											
60 V	I_e	A	22	32	45	63	80	125	160	200	
110 V	I_e	A	22	32	45	63	80	125	160	200	
220 V	I_e	A	6	32	45	63	80	125	160	200	
Current heat loss (3 pole)											
Current heat loss at I_{th}			W	3 - 5,1	6.6	13.2	16.5	25.8	22.2	36.3	57
Impedance per pole			mΩ	2.5	2.7	2.7	1.9	1.9	0.6	0.6	0.6
Magnet systems											
Voltage tolerance											
AC operated 50 Hz	Pick-up	$x U_c$	0.8 - 1.1	0.8 - 1.1	0.8 - 1.1	0.8 - 1.1 0.8 - 1.15 (RAC)	0.8 - 1.15				
AC operated 50/60 Hz		$x U_c$	0.8 - 1.1	0.85 - 1.1	0.85 - 1.1	0.85 - 1.1 0.8 - 1.15 (RAC)	0.8 - 1.15				
AC operated	Drop-out	$x U_c$	0.4 - 0.6	0.4 - 0.6	0.4 - 0.6	0.4 - 0.6 0.25 - 0.6 (RAC)	0.25 - 0.6				
DC operated ¹⁾	Pick-up	$x U_c$	0.8 - 1.1	0.7 - 1,2	0.7 - 1,2	0.7 - 1,2	0.7 - 1,2				
DC operated ¹⁾	Drop-out	$x U_c$	0.2 - 0.6	0.2 - 0.6	0.2 - 0.6	0.2 - 0.6	0.2 - 0.6				
Power consumption of the coil in a cold state and $1.0 \times U_c$											
AC operated 50/60 Hz	Pick-up	VA	24	50	150	45 (RAC)	180				
AC operated 50/60 Hz	Pick-up	W	19	40	95		150				
AC operated 50/60 Hz	Hold	VA	4	8	16	1.5 (RAC)	3.1				
AC operated 50/60 Hz	Hold	W	1.4	2.1	4.1	1.5 (RAC)	2.3				
DC operated ¹⁾	Pick-up	W	4.5	12	24		149				
DC operated ¹⁾	Hold	W	4.5	0.9	1		1.19				
Duty factor			% ED	100	100	100	100				
Changeover times at 100 % U_c (recommended values)											
Main contacts											
AC operated											
Closing time		ms	15 - 21	16 - 22	12 - 18	50 (RAC)	28 - 33				
Opening time		ms	9 - 18	8 - 14	8 - 13	45 (RAC)	35 - 41				
DC operated ¹⁾											
Closing time		ms	31	47	54		35				
Opening time		ms	12	30	24		30				
Arcing time		ms	10	10	10		15				
Permissible residual current when A1 - A2 are actuated from the electronic system (with 0 signal)			mA	≤ 1	≤ 1	≤ 1	≤ 1				

Notes¹⁾ At least double-pulse bridge rectifier

			DILMP20	DILMP32	DILMP45	DILMP63	DILMP80	DILMP125	DILMP160	DILMP200
Rating data for approved types										
Switching capacity										
Maximum motor rating										
3-phase										
	200 V, 208 V	HP	–	7.5	7.5	10	15	25	25	40
	230 V/240 V	HP	–	10	10	15	20	30	40	60
	460 V, 480 V	HP	–	15	15	30	40	60	75	125
	575 V, 600 V	HP	–	20	20	40	50	75	100	125
1-phase										
	115 V, 120 V	HP	–	2	2	3	3	7.5	7.5	10
	230 V/240 V	HP	–	5	5	7.5	10	15	15	30
	General use	A	20	40	40	63	80	125	125	180
Auxiliary contact										
Pilot duty										
	AC operated		–	A600	A600	–	–	–	–	–
	DC operated		–	P300	P300	–	–	–	–	–
General Use										
	AC	V	–	600	600	–	–	–	–	–
	AC	A	–	10	10	–	–	–	–	–
	DC	V	–	250	250	–	–	–	–	–
	DC	A	–	1	1	–	–	–	–	–
Short Circuit Current Rating (SCCR)										
Basic Rating										
	SCCR	kA	5	5	5	10	10	10	10	10
	max. Fuse	A	45	125	125	250	250	600	600	600
	max. CB	A	60	125	125	250	250	600	600	600
480 V High Fault										
	SCCR (fuse)	kA	30	10/100	10/100	30/100	30/100	30/100	30/100	30/100
	max. Fuse	A	25	125/70 Class RK5	125/70 Class J	250/150 Class J	250/150 Class J	300/300 Class J	300/300 Class J	300/300 Class J
	SCCR (CB)	kA	–	10/65	10/65	65	65	65	65	65
	max. CB	A	–	50/32	50/32	100	100	250	250	250
600 V High Fault										
	SCCR (fuse)	kA	30	10/100	10/100	30/100	30/100	30/100	30/100	30/100
	max. Fuse	A	25	125/100 Class RK5	125/100 Class J	250/150 Class J	250/150 Class J	300/300 Class J	300/300 Class J	300/300 Class J
	SCCR (CB)	kA	–	10/22	10/22	30	30	30	30	30
	max. CB	A	–	50/32	50/32	250	250	350	350	350
Special Purpose Ratings										
Electrical Discharge Lamps (Ballast)										
	480V 60Hz 3phase, 277V 60Hz 1phase	A	20	40	40	79	79	100	100	160
	600V 60Hz 3phase, 347V 60Hz 1phase	A	20	40	40	79	79	100	100	160
Incandescent Lamps (Tungsten)										
	480V 60Hz 3phase, 277V 60Hz 1phase	A	14	40	40	74	74	100	100	160
	600V 60Hz 3phase, 347V 60Hz 1phase	A	14	40	40	74	74	100	100	160
Resistance Air Heating										
	480V 60Hz 3phase, 277V 60Hz 1phase	A	20	40	40	79	79	110	110	160
	600V 60Hz 3phase, 347V 60Hz 1phase	A	20	40	40	79	79	110	110	160
Refrigeration Control (CSA only)										
	LRA 480V 60Hz 3phase	A	60	240	240	–	–	540	540	540
	FLA 480V 60Hz 3phase	A	10	40	40	–	–	90	90	90
	LRA 600V 60Hz 3phase	A	60	180	180	–	–	420	420	540
	FLA 600V 60Hz 3phase	A	10	30	30	–	–	70	70	90
Definite Purpose Ratings (100,000 cycles acc. to UL 1995)										
	LRA 480V 60Hz 3phase	A		150	150	–	–	–	–	–
	FLA 480V 60Hz 3phase	A		25	25	–	–	–	–	–
Elevator Control										
	200V 60Hz 3phase	HP	–	3	3	7.5	10	20	20	30
	200V 60Hz 3phase	A	–	11	11	25.3	32.2	62.1	62.1	92
	240V 60Hz 3phase	HP	–	5	5	10	15	25	30	40
	240V 60Hz 3phase	A	–	15.2	15.2	28	42	68	80	104
	480V 60Hz 3phase	HP	–	10	10	25	30	50	60	75
	480V 60Hz 3phase	A	–	14	14	34	40	65	77	96
	600V 60Hz 3phase	HP	5	15	15	30	40	60	75	100
	600V 60Hz 3phase	A	6.1	17	17	32	41	62	77	99

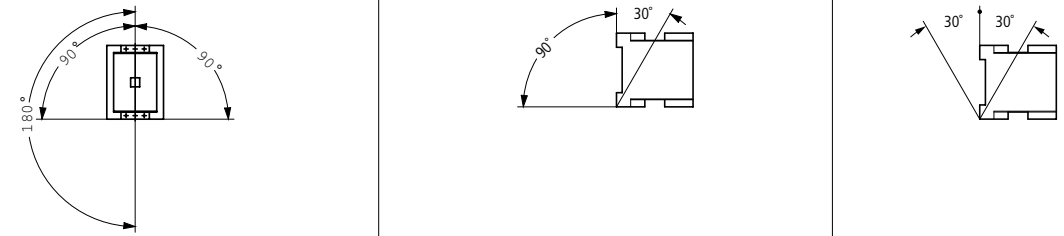
		DILK12	DILK20	DILK25	DILK33	DILK50
General						
Standards	IEC/EN 60947, VDE 0660					
Ambient temperature						
Open	°C	-25 - 60	-25 - 60	-25 - 60	-25 - 60	-25 - 60
Enclosed	°C	-25 - 40	-25 - 40	-25 - 40	-25 - 40	-25 - 40
Mounting position						
						
Protection rating		IP00	IP00	IP00	IP00	IP00
Busbar tag shroud when actuated vertically from front (EN 50274)	Finger- and back-of-hand proof					
Weight basic device	kg	0.51	0.51	0.51	1.17	1.17
Terminal capacities, main cable (Cu cable)						
Solid	mm ²	1 x (0.75 - 16)	1 x (0.75 - 16)	1 x (0.75 - 16)	1 x (2.5 - 16)	1 x (2.5 - 16)
flexible with ferrule	mm ²	1 x (0.75 - 16)	1 x (0.75 - 16)	1 x (0.75 - 16)	1 x (2.5 - 35)	1 x (2.5 - 35)
Stranded	mm ²	1 x 16	1 x 16	1 x 16	1 x (16 - 50)	1 x (16 - 50)
Solid or stranded	AWG	18 - 16	18 - 6	18 - 6	12 - 2	12 - 2
Flat conductor	Number of segments x width x thickness	mm	–	–	1 x (6 x 9 x 0,8)	1 x (6 x 9 x 0,8)
Group compensation						
Rated power of three-phase capacitors, 50 - 60 Hz						
230 V	kvar	7.5	11	15	20	25
400 V	kvar	12.5	20	25	33.3	50
525 V	kvar	16.7	25	33.3	40	65
690 V	kvar	20	33.3	40	55	85
Rated operational current I_e of three-phase capacitors, 50 - 60 Hz						
Open						
230 V	I_e	A	18	29	38	50
400 V	I_e	A	18	29	38	50
525 V	I_e	A	18	29	38	50
690 V	I_e	A	18	29	38	50
Enclosed						
230 V	I_e	A	16	26	34	45
400 V	I_e	A	16	26	34	45
525 V	I_e	A	16	26	34	45
690 V	I_e	A	16	26	34	45
Making capacity (i-peak value) without damping	x I_e	180	180	180	180	180
Component lifespan	Operations	x 10 ⁶	0.15	0.15	0.15	0.15
Maximum operating frequency	Operations/h		120	120	120	120

			DILK12	DILK20	DILK25	DILK33	DILK50
Magnet systems							
Voltage tolerance							
AC operated	Pick-up	x U _c	0.8 - 1.1	0.8 - 1.1	0.8 - 1.1	0.8 - 1.15	0.8 - 1.15
AC operated	Drop-out	x U _c	0.3 - 0.6	0.3 - 0.6	0.3 - 0.6	0.3 - 0.6	0.3 - 0.6
Power consumption of the coil in a cold state and 1.0 x U _c							
50 Hz	Pick-up	VA	58	58	58	45	45
50 Hz	Hold	VA	7.6	7.6	7.6	1.5	1.5
50 Hz	Hold	W	2.1	2.1	2.1	4.1	4.1
60 Hz	Pick-up	VA	71	71	71	45	45
60 Hz	Hold	VA	9.3	9.3	9.3	1.5	1.5
60 Hz	Hold	W	2.1	2.1	2.1	4.1	4.1
50/60 Hz	Pick-up	VA	65	65	65	45	45
			59	59	59	45	45
50/60 Hz	Hold	VA	9.6	9.6	9.6	1.5	1.5
			7	7	7	1.5	1.5
50/60 Hz	Hold	W	2.1	2.1	2.1	4.1	4.1
			2.1	2.1	2.1	4.1	4.1
Duty factor		% ED	100	100	100	100	100
Changeover times at 100% U _c (recommended values)							
Main contacts, AC operated							
	Closing time	ms	16 - 22	16 - 22	16 - 22	50	50
	Opening time	ms	8 - 14	8 - 14	8 - 14	40	40
	Arcing time	ms	10	10	10	10	10
Electromagnetic compatibility (EMC)							
Emitted interference			EN 60947-1	EN 60947-1	EN 60947-1	EN 60947-1	EN 60947-1
Noise Immunity			EN 60947-1	EN 60947-1	EN 60947-1	EN 60947-1	EN 60947-1
Further technical data							
like the contactor	DIL		M17	M25	M32	M50	M65
Rating data for approved types							
Auxiliary contact ¹⁾							
Pilot duty							
	AC operated		A600	A600	A600	A600	A600
	DC operated		P300	P300	P300	P300	P300
General Use							
	AC	V	600	600	600	600	600
	AC	A	10	10	10	10	10
	DC	V	250	250	250	250	250
	DC	A	1	1	1	1	1
Capacitor Switching							
Special rating							
	240V 60Hz 3phase	A	18	28	36	48	72.1
	240V 60Hz 3phase	kVar	7.5	12	15	20	30
	480V 60Hz 3 phase	A	18	28	36	48	72.1
	480V 60Hz 3 phase	kVar	15	20	30	40	60
	600V 60Hz 3phase	A	14.4	28	38.4	48	72.1
	600V 60Hz 3phase	kVar	15	30	40	50	75

Notes ¹⁾ Not for DILK...(24V...)

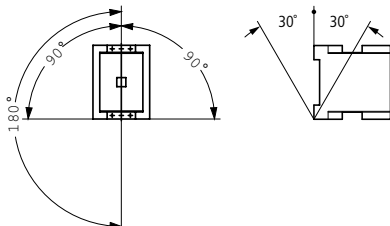
			DILL12	DILL18	DILL20
General					
Standards			IEC/EN 60947, VDE 0660, UL, CSA		
Mechanical lifespan, AC operated	Operations	x 10 ⁶	1	1	1
Mechanical operating frequency, AC operated	Operations/h		60	60	60
Maximum electrical operating frequency	Operations/h		60	60	60
Climatic proofing			Damp heat, constant, to IEC 60068-2-78 Damp heat, cyclic, to IEC 60068-2-30		
Ambient air temperature	Open	°C	-25 - 60	-25 - 60	-25 - 60
	Enclosed	°C	-25 - 40	-25 - 40	-25 - 40
	Storage	°C	-40 - 80	-40 - 80	-40 - 80
Mounting position					
Mechanical shock resistance (IEC/EN 60068-2-27), half/sinusoidal shock 10 ms		g	6.9	6.9	6.9
Protection rating			IP00	IP00	IP00
Weight		kg	0.42	0.42	0.42
Main circuits					
Rated impulse withstand voltage	U_{imp}	V AC	8000	8000	8000
Overvoltage category/degree of pollution			III/3	III/3	III/3
Rated insulation voltage	U_i	V AC	690	690	690
Rated operating voltage	U_e	V AC	690	690	690
Making capacity		A	238	350	550
Breaking Capacity	380/400 V	A	170	250	320
Lifespan, electrical	Operations		10000	10000	10000
Short-circuit protection max. Fuse					
400 V	gG/gL 500 V	A	63	100	125
Alternating voltage					
AC-1 operation					
Conventional thermal current					
	at 40 °C	$I_{th} = I_e$	A	27	40
	at 60 °C	$I_{th} = I_e$	A	24	35
AC-5a operation					
	220/230 V	I_e	A	12	18
	380/400 V	I_e	A	12	20
AC-5b operation					
	220/230 V	I_e	A	14	21
	380/400 V	I_e	A	14	27
Lighting load					
	filament lamp	A	14	21	27
	Mercury blended lamps	A	12	16	23
Fluorescent lamp load					
	Conventional reactor starter connection	A	20	26	35
	Duo circuit	A	20	26	35
	Electronic ballasts	A	12	18	20
	High-pressure mercury-arc lamps	A	12	18	20
	Halogen metal vapour lamp	A	12	18	20
	Sodium metal vapour arc lamps	A	12	18	20
	Low-pressure sodium lamps	A	7.5	10	12
	Maximum permissible compensation capacity	µF	470	470	470
Further technical data					
like the contactor	DIL		M17	M25	M32

DILMF8 DILMF11 DILMF14 DILMF17

General

Mounting position

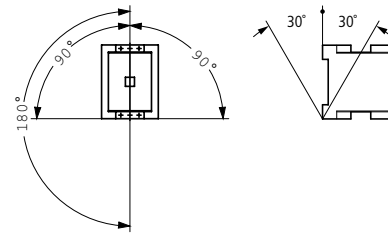

Alternating voltage

AC-3 operation

Rated operational current AC-3 open, 3-pole, 50 - 60 Hz	220/230 V	I_e	A	7	9	12	18
	240 V	I_e	A	7	9	12	18
	380/400 V	I_e	A	7	9	12	18
	415 V	I_e	A	7	9	12	18
	440 V	I_e	A	7	9	12	18
	500 V	I_e	A	5	7	10	18
	660/690 V	I_e	A	4	5	7	12
Motor rating	220/230 V	P	kW	2.2	2.5	3.5	5
	240 V	P	kW	2.2	3	4	5.5
	380/400 V	P	kW	3	4	5.5	7.5
	415 V	P	kW	4	5.5	7	10
	440 V	P	kW	4.5	5.5	7.5	10.5
	500 V	P	kW	3.5	4.5	7	12
	660/690 V	P	kW	3.5	4.5	6.5	11

AC-4 operation

Rated operational current AC-4 open, 3-pole, 50 - 60 Hz	220/230 V	I_e	A	5	6	7	10
	240 V	I_e	A	5	6	7	10
	380/400 V	I_e	A	5	6	7	10
	415 V	I_e	A	5	6	7	10
	440 V	I_e	A	5	6	7	10
	500 V	I_e	A	4.5	5	6	10
	660/690 V	I_e	A	4	4.5	5	8
Motor rating	220/230 V	P	kW	1	1.5	2	2.5
	240 V	P	kW	1.5	1.6	2.2	3
	380/400 V	P	kW	2.2	2.5	3	4.5
	415 V	P	kW	2.3	2.8	3.4	5
	440 V	P	kW	2.4	3	3.6	5.5
	500 V	P	kW	2.5	2.8	3.5	6
	660/690 V	P	kW	2.9	3.6	4.4	6.5

Current heat loss (3 pole)

Current heat loss at I_{th} (60 °C)	W	2.4	2.4	2.4	7.3
Current heat loss at I_e to AC-3/400 V	W	0.3	0.6	0.9	2.1

Magnet systems

Voltage tolerance	AC operated	Pick-up $\times U_c$	0.8 - 1.15	0.8 - 1.15	0.8 - 1.15	0.8 - 1.15
	AC operated	Drop-out $\times U_c$	0.2 - 5.0	0.2 - 5.0	0.2 - 5.0	0.2 - 5.0
Power consumption of the coil in a cold state and $1.0 \times U_c$	Electronic actuation	Pick-up VA	14	14	14	14
	Electronic actuation	Hold VA	0.7	0.7	0.7	0.7
	Electronic actuation	Hold W	0.8	0.8	0.8	0.8
Duty factor	% ED	100	100	100	100	
Switching times	Closing time	ms	40	40	40	40
	Opening time	ms	45	45	45	45
suitable according to		SEMI F47	SEMI F47	SEMI F47	SEMI F47	

Electromagnetic compatibility (EMC)

Emitted interference	EN 60947-1	EN 60947-1	EN 60947-1	EN 60947-1
Noise Immunity	EN 60947-1	EN 60947-1	EN 60947-1	EN 60947-1

Further technical data

like the contactor	DIL	M7	M9	M12	M17
Connection technology					
like the contactor	DIL	M17	M17	M17	M17

DILMF25	DILMF32	DILMF40	DILMF50	DILMF65	DILMF80	DILMF95	DILMF115	DILMF150
25	32	40	50	65	80	95	115	150
25	32	40	50	65	80	95	115	150
25	32	40	50	65	80	95	115	150
25	32	40	50	65	80	95	115	150
25	32	40	50	65	80	95	115	150
25	32	40	50	65	80	95	115	150
15	18	25	32	37	65	80	93	100
7.5	10	12.5	15.5	20	25	30	37	48
8.5	11	13.5	17	22	27.5	32	40	52
11	15	18.5	22	30	37	45	55	75
14.5	19	24	30	39	48	57	70	91
15.5	20	25	32	41	51	60	75	95
17.5	23	28	36	47	58	70	85	110
14	17	23	30	35	63	75	90	96
13	15	18	21	25	40	50	55	65
13	15	18	21	25	40	50	55	65
13	15	18	21	25	40	50	55	65
13	15	18	21	25	40	50	55	65
13	15	18	21	25	40	50	55	65
10	12	14	17	20	27	37	45	50
3.5	4	5	6	7	12	16	17	20
4	4.5	5.5	6.5	7.5	13	17	19	22
6	7	9	10	12	20	26	28	33
6.5	7.5	9.5	11	13	24	30	33	39
7	8	10	12	14	25	32	35	41
8	9	11	13	16	29	36	40	47
8.5	10	12	14	17	26	35	43	48
9.6	12.1	11.3	19	28.8	14.6	21.8	30.4	46.1
4.2	6.6	6.6	9.9	17.1	9	12.6	18.9	32.1
0.8 - 1.15	0.8 - 1.15	0.8 - 1.15	0.8 - 1.15	0.8 - 1.15	0.8 - 1.15	0.8 - 1.15	0.8 - 1.15	0.8 - 1.15
0.2 - 5.0	0.2 - 5.0	0.2 - 5.0	0.2 - 5.0	0.2 - 5.0	0.2 - 5.0	0.2 - 5.0	0.2 - 5.0	0.2 - 5.0
14	14	45	45	45	75	75	180	180
0.7	0.7	1.5	1.5	1.5	2	2	3.1	3.1
0.8	0.8	1.3	1.3	1.3	2	2	2.3	2.3
100	100	100	100	100	100	100	100	100
40	40	50	50	50	55	55	40	40
45	45	45	45	45	40	40	40	40
SEMI F47	SEMI F47	SEMI F47	SEMI F47	SEMI F47	SEMI F47	SEMI F47	SEMI F47	SEMI F47
EN 60947-1	EN 60947-1	EN 60947-1	EN 60947-1	EN 60947-1	EN 60947-1	EN 60947-1	EN 60947-1	EN 60947-1
EN 60947-1	EN 60947-1	EN 60947-1	EN 60947-1	EN 60947-1	EN 60947-1	EN 60947-1	EN 60947-1	EN 60947-1
M25	M32	M40	M50	M65	M80	M95	M115	M150
M25	M32	M40	M50	M65	M80	M95	M115	M150

		DILMF8	DILMF11	DILMF14	DILMF17	DILMF25
Rating data for approved types						
Switching capacity						
Maximum motor rating						
3-phase						
200/208 V	HP	5	5	5	5	7.5
230/240 V	HP	5	5	5	5	10
460/480 V	HP	10	10	10	10	15
575/600 V	HP	15	15	15	15	20
1-phase						
115/120 V	HP	2	2	2	2	2
230/240 V	HP	3	3	3	3	5
General use	A	40	40	40	40	40
Auxiliary contact						
Pilot duty						
AC operated		A600	A600	A600	A600	A600
DC operated		P300	P300	P300	P300	P300
General Use						
AC	V	600	600	600	600	600
AC	A	10	10	10	10	10
DC	V	250	250	250	250	250
DC	A	1	1	1	1	1
Short Circuit Current Rating (SCCR)						
Basic Rating						
SCCR	kA	5	5	5	5	5
max. Fuse	A	125	125	125	125	125
max. CB	A	125	125	125	125	125
480 V High Fault						
SCCR (fuse)	kA	10/100	10/100	10/100	10/100	10/100
max. Fuse	A	125/70 Class J	125/70 Class J	125/70 Class J	125/70 Class J	125/70 Class J
SCCR (CB)	kA	10/65	10/65	10/65	10/65	10/65
max. CB	A	50/32	50/32	50/32	50/32	50/32
600 V High Fault						
SCCR (fuse)	kA	10/100	10/100	10/100	10/100	10/100
max. Fuse	A	125/70 Class J	125/70 Class J	125/70 Class J	125/70 Class J	125/100 Class J
SCCR (CB)	kA	10/22	10/22	10/22	10/22	10/22
max. CB	A	50/32	50/32	50/32	50/32	50/32

DILMF32	DILMF40	DILMF50	DILMF65	DILMF80	DILMF95	DILMF115	DILMF150
10	10	15	20	25	30	40	50
10	15	20	25	30	40	50	60
20	30	40	50	60	75	100	125
25	40	50	60	75	100	100	125
2	3	3	5	7.5	7.5	10	10
5	7.5	10	15	15	15	25	30
40	63	80	88	125	125	180	225
A600	–	–	–	–	–	–	–
P300	–	–	–	–	–	–	–
600	–	–	–	–	–	–	–
10	–	–	–	–	–	–	–
250	–	–	–	–	–	–	–
1	–	–	–	–	–	–	–
5	10	10	10	10	10	10	10
125	250	250	250	600	600	600	600
125	250	250	250	600	600	600	600
10/100	30/100	30/100	30/100	30/100	30/100	30/100	30/100
125/70 Class J	250/150 Class J	250/150 Class J	250/150 Class J	300/300 Class J	300/300 Class J	300/300 Class J	300/300 Class J
10/65	65	65	65	65	65	65	65
50/32	100	100	100	250	250	250	250
10/100	30/100	30/100	30/100	30/100	30/100	30/100	30/100
125/125 Class J	250/150 Class J	250/150 Class J	250/150 Class J	300/300 Class J	300/300 Class J	300/300 Class J	300/600 Class J
10/22	30	30	30	30	30	30	30
50/32	250	250	250	350	350	350	350

		DILMF8	DILMF11	DILMF14	DILMF17
Rating data for approved types					
Short Circuit Current Rating (cont.)					
Special Purpose Ratings					
Electrical Discharge Lamps (Ballast)					
480V 60Hz 3phase, 277V 60Hz 1phase	A	40	40	40	40
600V 60Hz 3phase, 347V 60Hz 1phase	A	40	40	40	40
Incandescent Lamps (Tungsten)					
480V 60Hz 3phase, 277V 60Hz 1phase	A	40	40	40	40
600V 60Hz 3phase, 347V 60Hz 1phase	A	40	40	40	40
Resistance Air Heating					
480V 60Hz 3phase, 277V 60Hz 1phase	A	40	40	40	40
600V 60Hz 3phase, 347V 60Hz 1phase	A	40	40	40	40
Refrigeration Control (CSA only)					
LRA 480V 60Hz 3phase	A	240	240	240	240
FLA 480V 60Hz 3phase	A	40	40	40	40
LRA 600V 60Hz 3phase	A	180	180	180	180
FLA 600V 60Hz 3phase	A	30	30	30	30
Definite Purpose Ratings (100,000 cycles acc. to UL 1995)					
LRA 480V 60Hz 3phase	A	108	108	108	108
FLA 480V 60Hz 3phase	A	18	18	18	18
Elevator Control					
200V 60Hz 3phase	HP	3	3	3	3
200V 60Hz 3phase	A	11	11	11	11
240V 60Hz 3phase	HP	3	3	3	3
240V 60Hz 3phase	A	9.6	9.6	9.6	9.6
480V 60Hz 3phase	HP	7.5	7.5	7.5	7.5
480V 60Hz 3phase	A	11	11	11	11
600V 60Hz 3phase	HP	10	10	10	10
600V 60Hz 3phase	A	11	11	11	11

DILMF25	DILMF32	DILMF40	DILMF50	DILMF65	DILMF80	DILMF95	DILMF115	DILMF150
40	40	79	79	88	100	100	160	160
40	40	79	79	88	100	100	160	160
40	40	74	74	88	100	100	160	160
40	40	74	74	88	100	100	160	160
40	40	79	79	88	100	100	160	160
40	40	79	79	88	100	100	160	160
240	240	–	–	–	540	540	540	540
40	40	–	–	–	90	90	84	90
180	180	–	–	–	420	420	540	540
30	30	–	–	–	70	70	84	90
150	192	–	–	390	480	570	690	900
25	32	–	–	65	80	95	115	150
3	7.5	7.5	10	10	20	20	30	30
11	25.3	25.3	32.2	32.2	62.1	62.1	92	92
5	7.5	10	15	15	25	30	40	40
15.2	22	28	42	42	68	80	104	104
10	20	25	30	30	50	60	75	75
14	27	34	40	40	65	77	96	96
15	20	30	40	40	60	75	100	100
17	22	32	41	41	62	77	99	99

			DILM7-... - DILM38-...	DILA- XHI(C)...(-S)	DILM32- XHI(C)...(-S)	DILM150- XHI(C)...	DILM1000-XHI... DILM820-XHI...	
Auxiliary contact								
Interlocked opposing contacts within an auxiliary contact module (to IEC 60947-5-1 appendix L) ¹⁾			–	yes	yes	yes	yes	
Break contact (not NC late-break) suitable as a mirror contact (to IEC/EN 60947-4-1 appendix F)			DILM7 – DILM38	DILM7 – DILM38	DILM7 – DILM38	DILM80 - DILM170	DILM40 - DILM225A DILM250 - DILH2600	
Rated impulse withstand voltage	U_{imp}	V AC	6000	6000	6000	6000	6000	
Overvoltage category/degree of pollution			III/3	III/3	III/3	III/3	III/3	
Rated insulation voltage	U_i	V AC	690	690	690	690	690	
Rated operating voltage	U_e	V AC	500	500	500	500	500	
Safe isolation according to EN 61140								
Between coil and auxiliary contacts			V AC	400	400	400	440	440
Between the auxiliary contacts			V AC	400	400	400	440	440
Rated operational current								
AC-15								
230 V	I_e	A	4	4	4	6	4	
380/415 V	I_e	A	4	4	4	4	4	
500 V	I_e	A	1.5	1.5	1.5	1.5	1.5	
DC time ≤ 15 ms ²⁾								
24 V	I_e	A	10	10	10	10	10	
60 V	I_e	A	6	6	6	6	6	
110 V	I_e	A	3	3	3	3	3	
220 V	I_e	A	1	1	1	1	1	
DC-13 (6xP)								
Contacts in series								
	1	24 V	A	2.5	2.5	2.5	–	2
	1	60 V	A	1	1	1	–	1.5
	1	110 V	A	0.5	0.5	0.5	–	0.8
	1	220 V	A	0.25	0.25	0.25	–	0.3
Conventional thermal current			I_{th}	A	10	16	16	10
Contact reliability (for $U_e = 24$ V DC, $U_{min} = 17$ V, $I_{min} = 5.4$ mA)			Fault probability	λ	< 10^{-8} (i.e. less than one failure per 100 million switchings)			
Component lifespan with $U_e = 230$ V, AC-15, 3 A			Operations	$\times 10^6$	1.3	1.3	1.3	1.3
Short-circuit strength without welding								
max. Fuse			A gG/gL	10	10	10	16	16

Notes¹⁾ Not with DIL...-XHIV and DIL...-XHICV.²⁾ Switch-on and switch-off conditions based on DC-13, time constant as specified.

			P1DILEM DILM12-XP1	DILM32-XP1	DILM65-XP1	DILM150-XP1	DILM185-XP1
Parallel connector							
Terminal capacities (Cu cable)							
Solid		mm ²	1 - 16	16	16	–	–
flexible with ferrule		mm ²	1 x (0.5 - 25) 2 x (0.5 - 16)	1 x (16 - 35)	1 x (16 - 120)	–	–
Stranded		mm ²	1 x (0.5 - 25) 2 x (0.5 - 16)	1 x (16 - 50)	1 x (16 - 120)	1 x (35 - 300) 2 x (35 - 120)	–
Flat conductor	Number of segments x width x thickness	mm	6 x 9 x 0.8	–	–	2 x (11 x 21 x 1)	1 x (6 x 16 x 0,8) 2 x (20 x 32 x 0,5) 2 x (11 x 21 x 1)
Tightening torque		Nm	4	4	14	14	6
Terminal capacity control circuit cable							
Solid		mm ²	–	–	–	–	1 x (0.75 - 4) 2 x (0.75 - 4)
flexible with ferrule		mm ²	–	–	–	–	1 x (0.75 - 2.5) 2 x (0.75 - 2.5)
Tool							
Pozidriv screwdriver		Size	2	2	–	–	–
Hexagon socket-head screw	SW	mm	–	–	5	6	5
Conventional thermal current							
3-pole	I _{th}	A	50	100	180	400	700
4-pole	I _{th}	A	60	–	–	–	–

Dimensions

Mini contactors

DILER-...(-C)
DILER-...-G(-C)

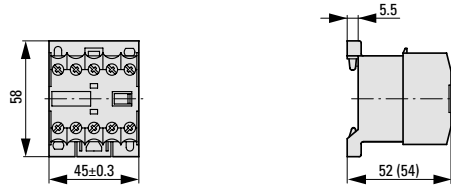

DILER-...(-C) + ...DILE(-C)
DILER-...-G(-C) + ...DILE(-C)

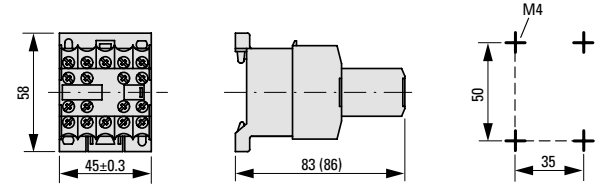

DILEEM-..., DILEM-...(-C), DILEM-12-...
DILEEM-...-G, DILEM-...-G(-C), DILEM-12-...-G

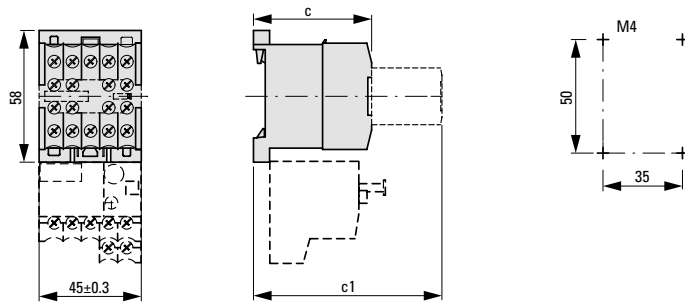

DILER-... + HDILE
DILER-...-G + HDILE



2 x DILE-... + MVDILE
2 x DILE-...-G + MVDILE

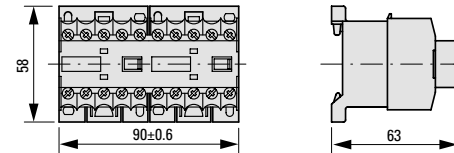

Suppressor circuit

DILE-... + RCDILE...
DILE-... + VGDILE...

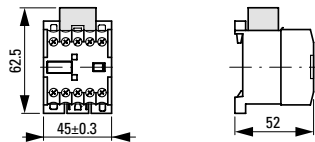

2 x DILE-... + MVDILE + ...DILE
2 x DILE-...-G + MVDILE + ...DILE

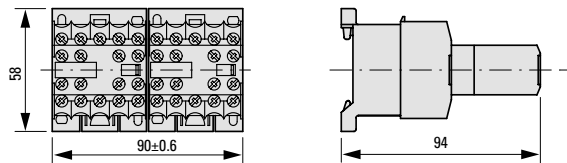

Reversing contactors

DIULEM

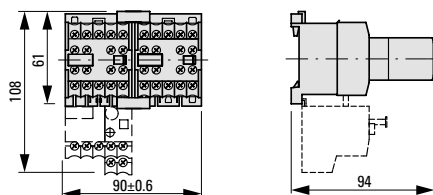

Parallel connector

DIL(E)EM... + P1DILEM

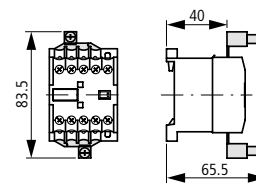

Contactor with auxiliary contact module

DILM7 – DILM15
DILA...

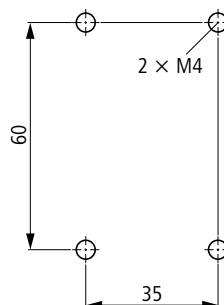
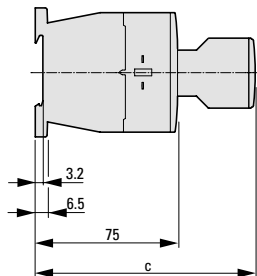
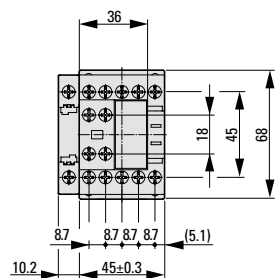

Type	c
DILM32-XHI	117
DILA-XHI	117
DILA-XHI...T	125

DILMC7 – DILMC15
DILAC...
DILA-XHIC...
DILM32-XHIC...

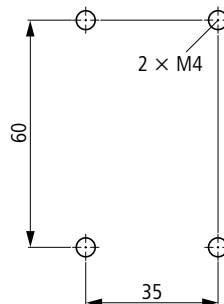
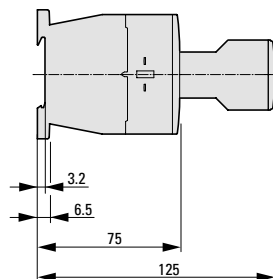
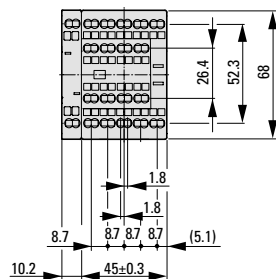

DILM17 – DILM38
DILMC17 – DILMC32
DILMF8 – DILMF32

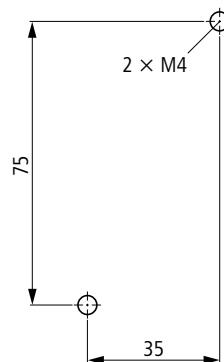
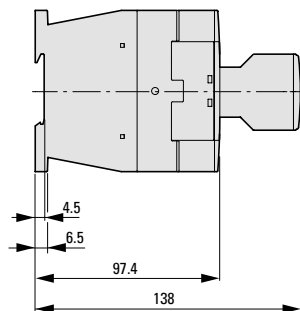
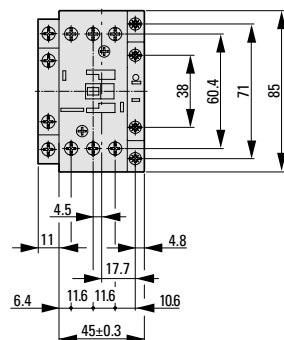

distance at side to earthed parts: 6 mm

Contactors

DILM40 – DILM72
 DILMC40 – DILMC65
 DILMF40 – DILMF65

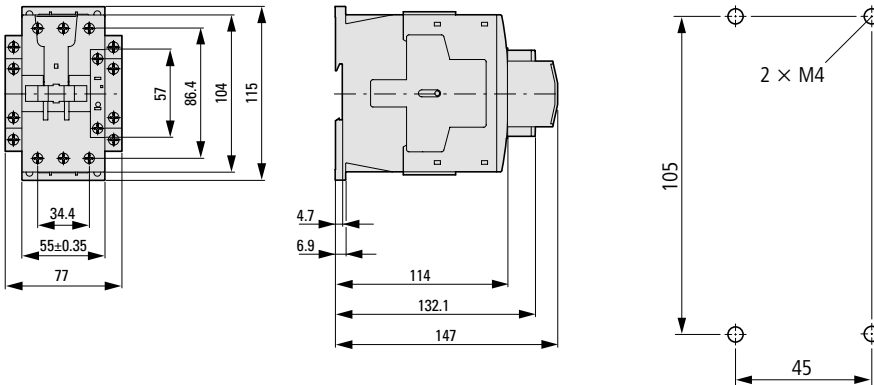

distance at side to earthed parts: 6 mm

DILM80 – DILM170
 DILMC80 – DILMC150
 DILMF80 – DILMF150

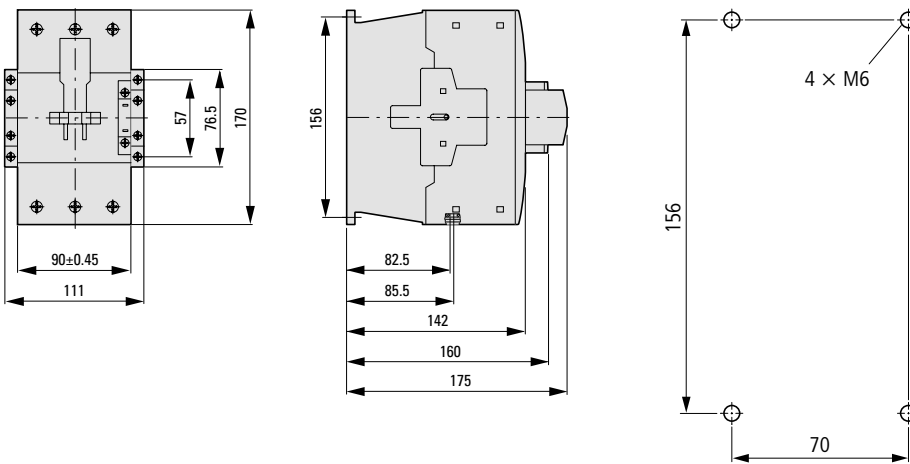

distance at side to earthed parts: 10 mm

Suppressor circuits

DILM...XSP...

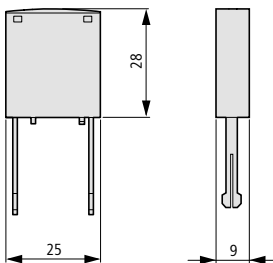

DILM...XSPVL...

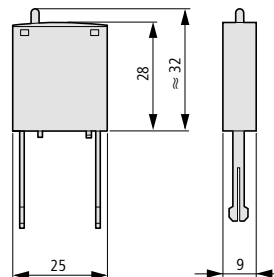

Contactor with auxiliary contact module

DILMP20

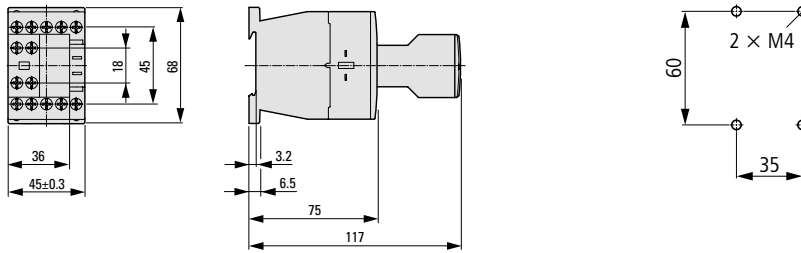

DILMP32
DILMP45

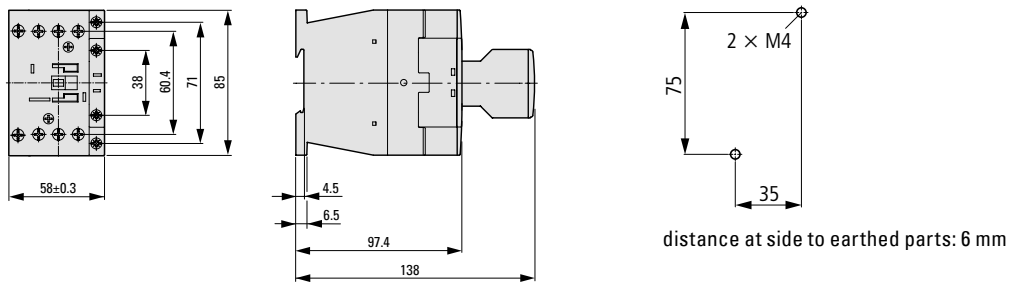

Contactors

DILMP63
DILMP80

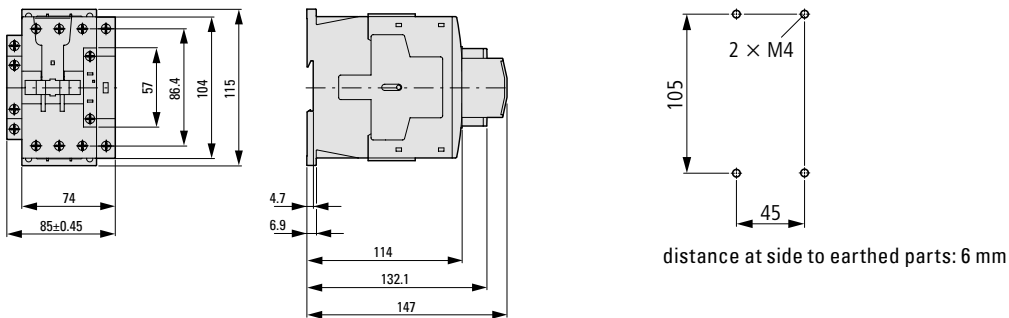

DILMP125
DILMP160
DILMP200

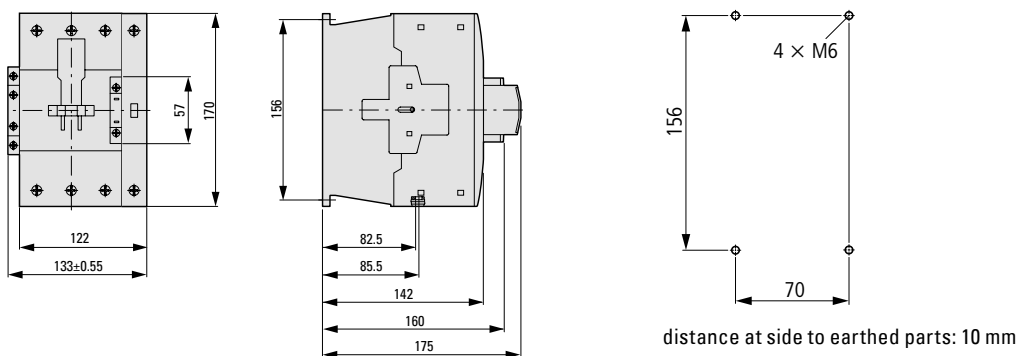

Motor suppressor module

DILM12-XMSM



Complete units

DILM185A – DILM500
DILM200 – DILM500

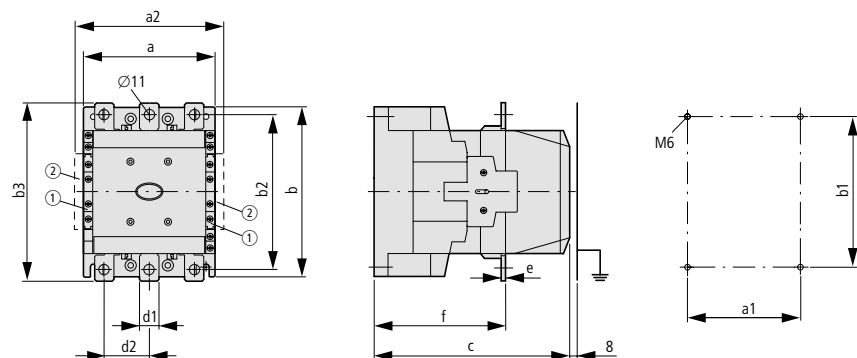

- ① DILM1000-XHI...-SI / DILM820-XHI...-SI
- ② DILM1000-XHI11-SA / DILM820-XHI...-SA

Type	a	a1	a2	b	b1	b2	b3	c	d1	d2	e	f
DILM185A	140	120	160	180	160	165	190	158	20	41	5	83
DILM225A	140	120	160	180	160	165	190	158	20	41	5	83
DILM250	140	120	160	180	160	164	189	208	25	48	5	140
DILM300A	140	120	160	180	160	164	189	208	25	48	5	140
DILM400	160	130	180	200	180	184	209	216	25	48	6	140
DILM500	160	130	180	200	180	189	219	216	38	57	6	140

DILM580 – DILM1000

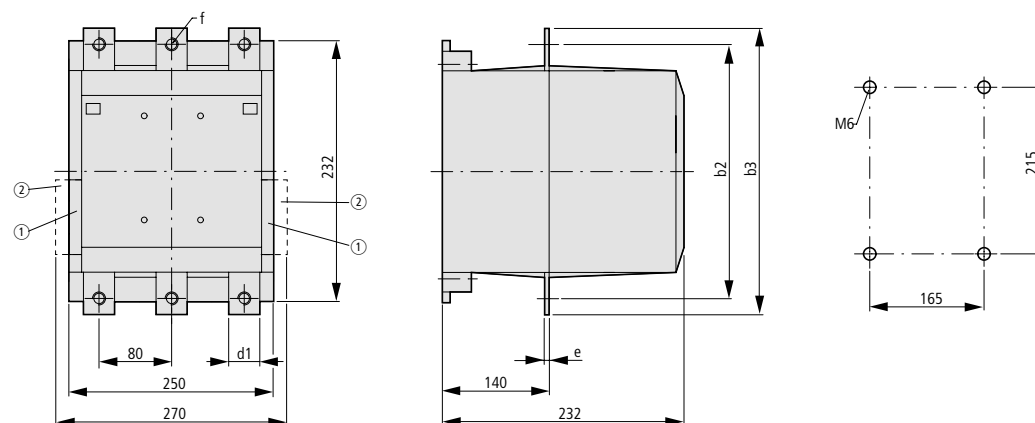

- ① DILM820-XHI...-SI
- ② DILM820-XHI11-SA

Type	b2	b3	d1	e	f
DILM580	256	296	45	6	13.5
DILM650	256	296	45	6	13.5
DILM750	256	296	45	6	13.5
DILM820	256	296	45	6	13.5
DILM1000	256	296	45	10	13.5

AC-1 contactors greater than 1000 A

DILH1400

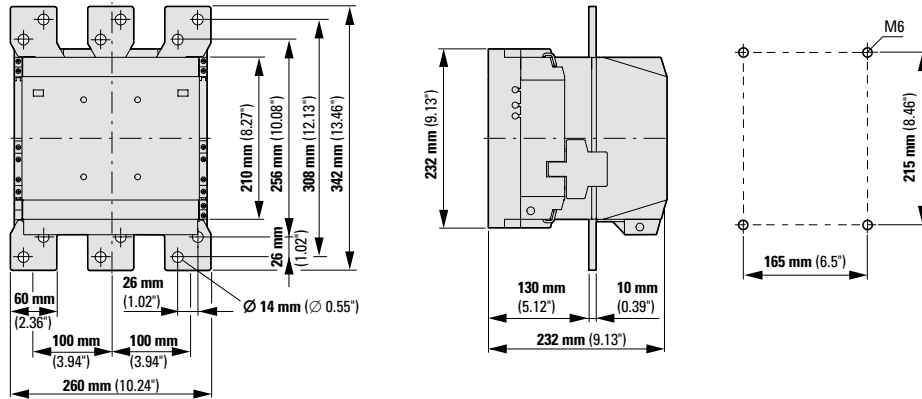

DILM1600
DILH2000
DILH2200

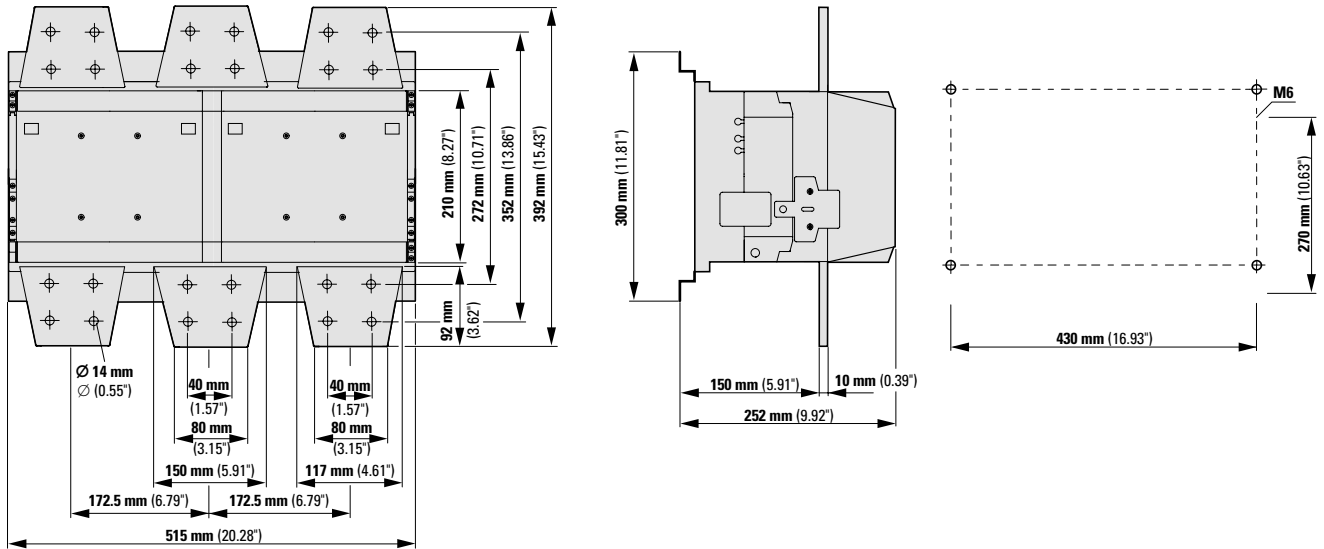

DILH2600

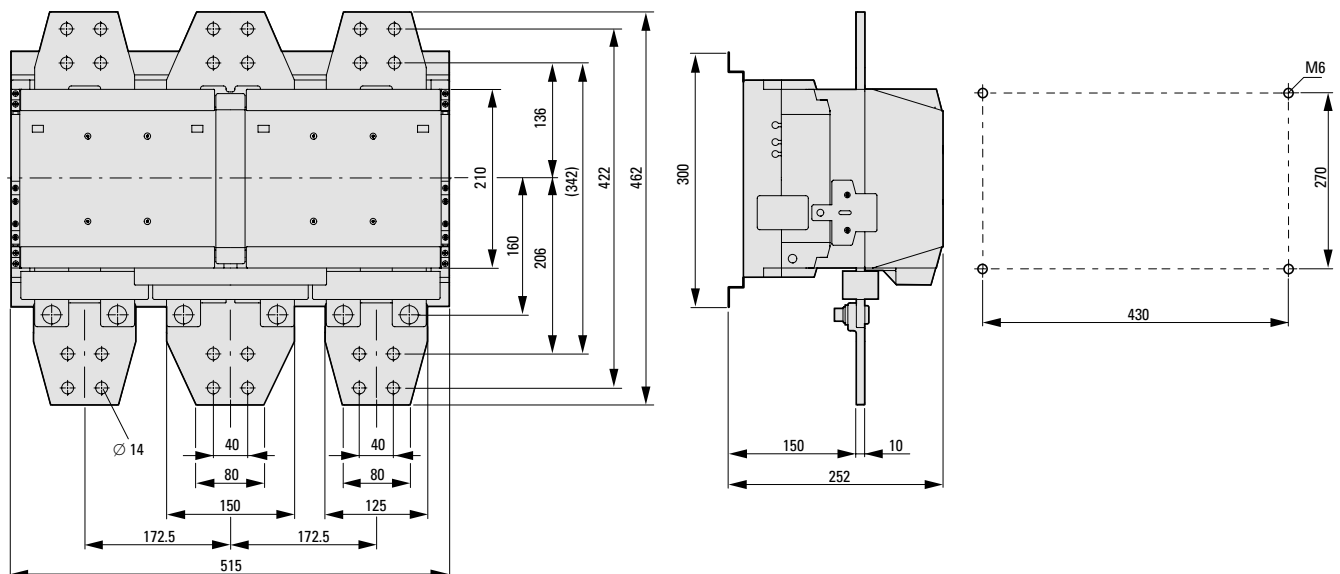

1

Contactors for capacitors with series resistors

DILK...

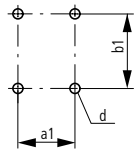
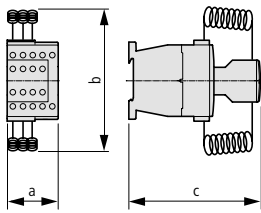

Type	a	b	c	a1	b1	d
DILK12	45	135	138	35	75	2 x M4
DILK20	45	135	138	35	75	2 x M4
DILK25	45	135	138	35	75	2 x M4
DILK33	55	190	147	45	105	2 x M4
DILK50	55	190	147	45	105	2 x M4

Contactors for lighting

DILL...

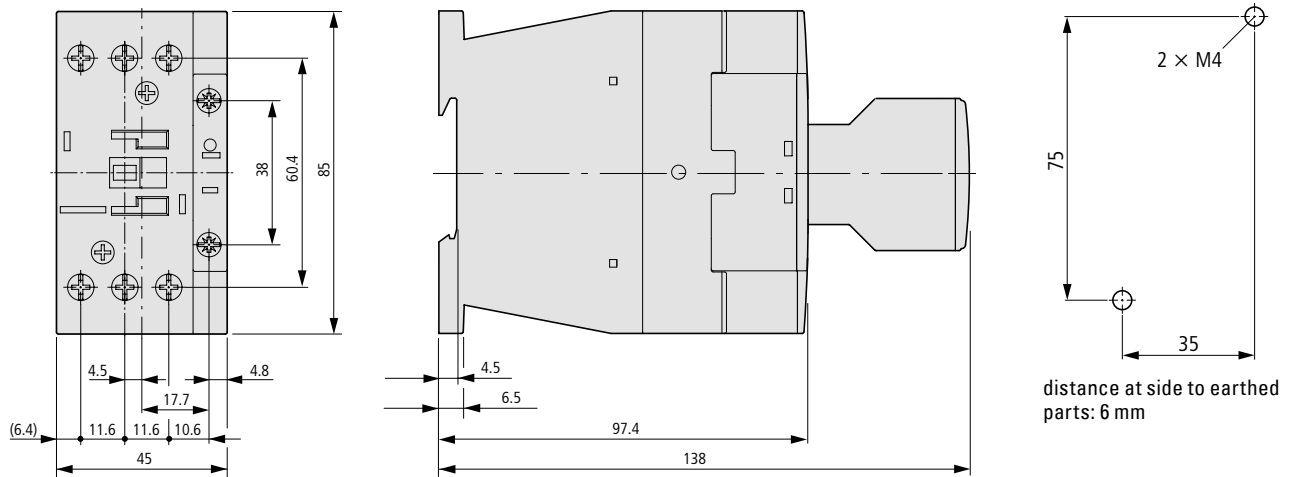

Contactors monitoring devices

CMD(...)

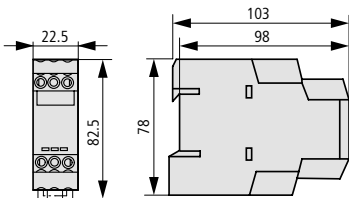

SWD contactor modules

DIL-SWD-32-...

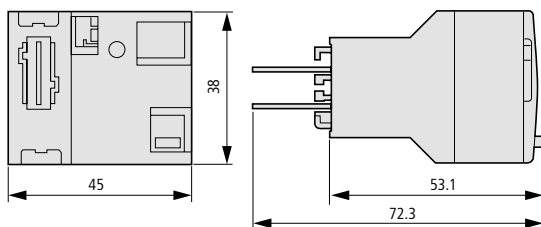

Star-delta contactors

SDAINLM12 – SDAINLM115

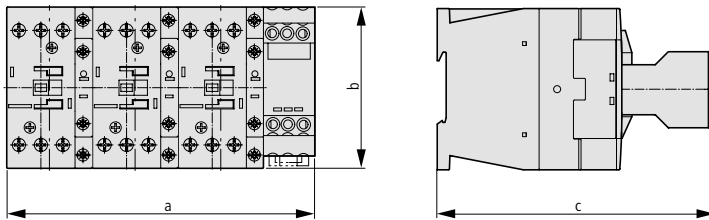

Type	a	b	c
SDAINLM12 – SDAINLM22	158	68	117
SDAINLM30 – SDAINLM55	158	85	138
SDAINLM70 – SDAINLM115	188	115	147

SDAINLM140 – SDAINLM260

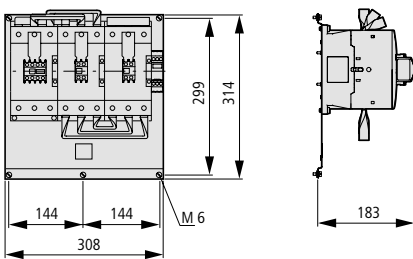

Reversing contactors

DIULM7 – DIULM65

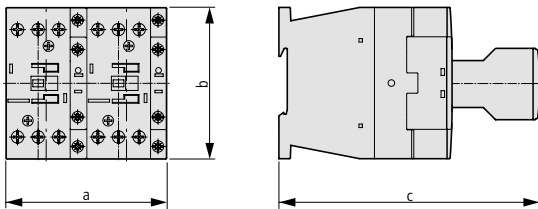

Type	a	b	c
DIULM7/21 – DIULM12/21	90	68	117
DIULM7/21 – DIULM32/21	90	85	138
DIULM40/11 – DIULM65/11	110	115	147

DIULM80 – DIULM150

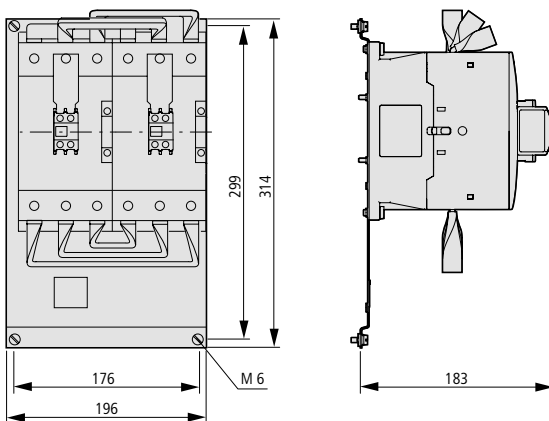

1

Three-phase commoning links

DILM12-XDSB...

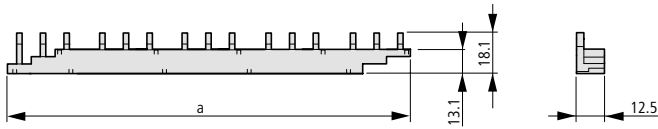

Type	a
DILM12-XDSB0/3	112
DILM12-XDSB0/4	157
DILM12-XDSB0/5	202

Electronic timer modules

DILM32-XTE...

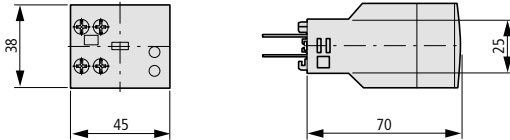

Amplifier module

ETS4-VS3

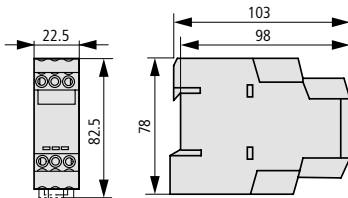

Contactors with terminal shrouds

DILM250 – DILM1000 + DILM...-XHB

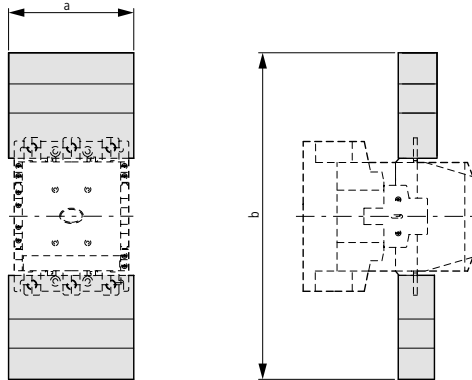

for part no.	a	b
DILM250, DILM300A	150	384
DILM400	150	404
DILM500	174	426
DILM580 – DILM1000	236	506

DILM250 + Z5-.../FF250

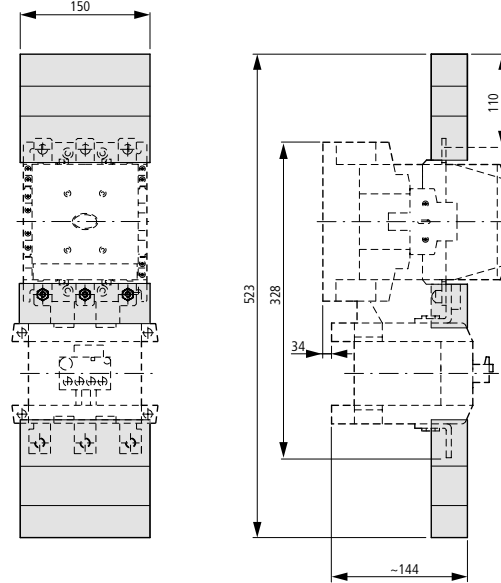

DILM185A – DILM225A + DILM225A-XHB

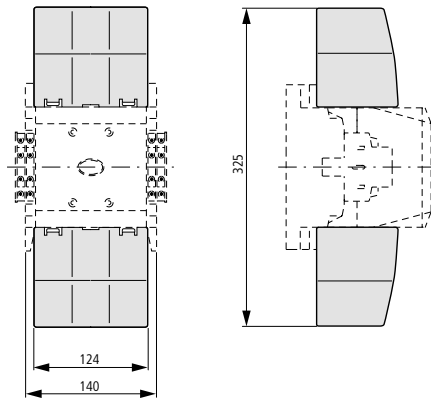

Contactor with star-point bridge and terminal shroud

DILM...XS1

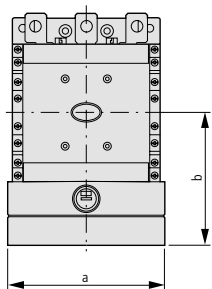

for part no.	a	b
DILM185A – DILM250	150	127
DILM300A – DILM400	150	137
DILM500	176	146

Mechanical interlock

DILM500-XMV

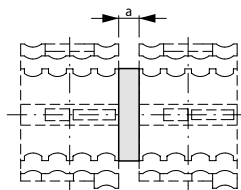

for part no.	a
DILM185A – DILM500	15

DILM820-XMV

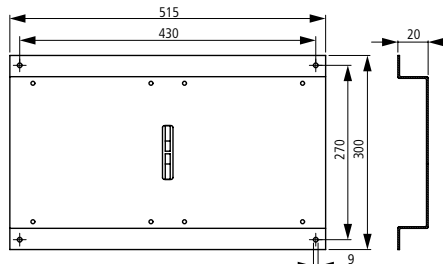

Build it in.



Greater motor protection – flexible and secure



Motor protection is one of the central tasks of the electrical equipment of machines. Inexpensive bimetal solutions through to an electronic configurable motor protection offer the correct solution for any application.

The electronic overload relays in the ZEB series provide an optimum solution for greater motor protection. They cover the current range up to 175 A and can be flexibly fitted direct to the DILM contactor or positioned anywhere in the control panel in separate mountings.

The protection for phase failure and overload, in combination with the selectable phase failure sensitivity as well as the visual overload early warning by LED devices, guarantee utmost reliability. In addition, the self-supplying electronics make it unnecessary to connect an external supply voltage.

As devices for world markets, all the motor protection devices from Eaton fulfill the respective requirements such as the classification in accordance with UL/CSA and CCC, and they are certified as motor protection systems as defined by ATEX.

ZB32



2.0	Motor protection relay	
2.1	Technical overview	2/2
	Bimetal relay, transformer relay	2/2
	Electronic overload protection relay	2/4
2.2	Product selection	2/6
	Bimetal relay ZE for mini contactor relays	2/6
	Bimetal relay ZB12, ZB32 to 150 A	2/8
	Bimetal relay ZB65, ZB150 to 150 A	2/10
	Bimetal relay Z5 to 300 A, transformer relay ZW7	2/12
	Electronic overload relay ZEB12, ZEB32 to 175 A	2/14
	Electronic overload relay ZEB65, ZEB150, ZEB225 to 175 A	2/16
2.3	Engineering	2/18
	Accessories ZEB-X..., selection aids ZEB	2/18
2.4	Product selection	2/19
	Accessories	2/19
	Covers Z5/FF	2/20
2.5	Engineering	2/21
	Selection criteria ZE, ZB, Z5, ZW7	2/21
2.6	Technical Data	2/22
	Bimetal relay ZE, ZB	2/22
	Bimetal relay Z5, transformer relay ZW7	2/23
	Bimetal relay ZE, ZB, Z5, transformer relay ZW7	2/24
	UL/CSA short-circuit rating	2/25
	Electronic overload relays up to 1500 A	2/26
2.7	Dimensions	2/28
	Bimetal relay ZE, ZB	2/28
	Bimetal relay ZB	2/29
	Bimetal relay ZB, Z5	2/30
	Transformer relay ZW7, electronic overload relay ZEB	2/31
	Electronic overload relay ZEB	2/32

Overload relay, CT-operated overload relay

Technical overview

2

Setting ranges (A)
(note max. current of the contactor)

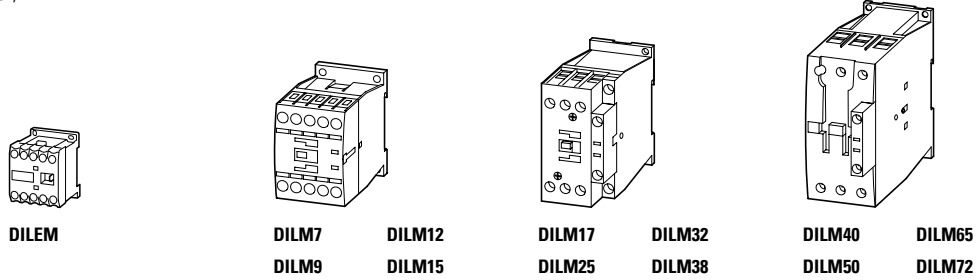

Bimetallic relay

ZE
0.1 - 12

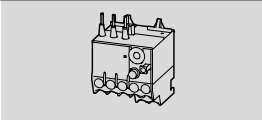

ZB12
0.1 - 16

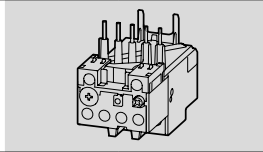

ZB32
0.1 - 38

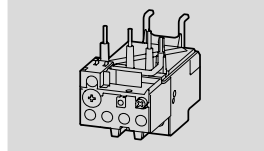

ZB65
6 - 75

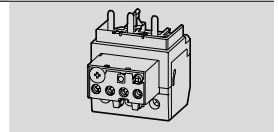

ZB150
35 - 175

Z5.../FF225A
70 - 250

Z5.../FF250
50 - 300

Transformer relay

ZW7...
42 - 630

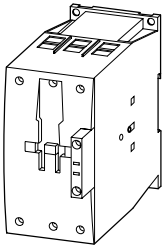

DILM80
DILM95
DILM115

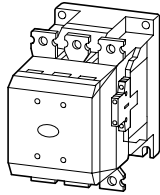

DILM150
DILM170

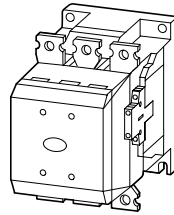

DILM185A
DILM225A

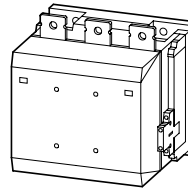

DILM250
DILM300A

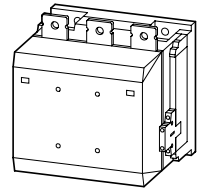

DILM400
DILM500

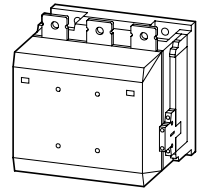

DILM580
DILM650

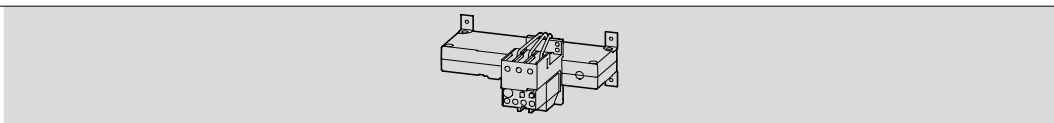
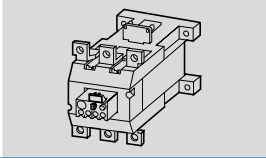
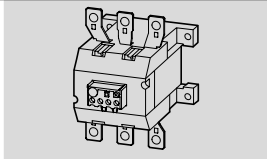
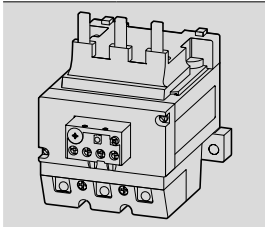

2.1

Motor protection relay

Moeller series

Electronic overload relays

Setting ranges (A)
(note max. current of the contactor)

2



DILEM

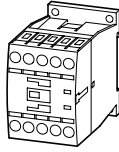

DILM7
DILM9

DILM12
DILM15

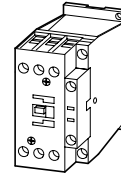

DILM17
DILM25

DILM32
DILM38

Electronic overload relays

ZEB12
0.33 - 20

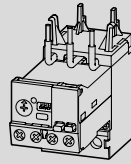

ZEB32
0.33 - 45

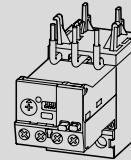

ZEB65
9 - 100

ZEB150
20 - 100

ZEB225
35 - 175

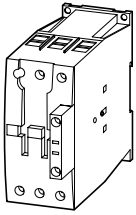

DILM40
DILM50

DILM65
DILM72

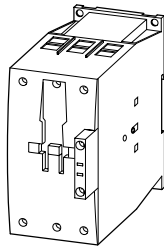

DILM80
DILM95
DILM115

DILM150
DILM170

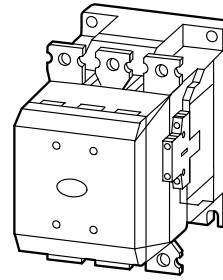

DILM185A
DILM225A

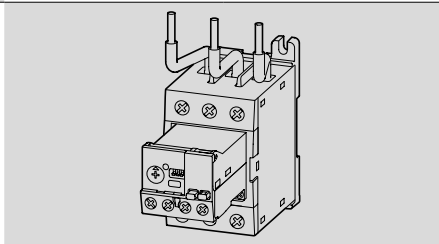
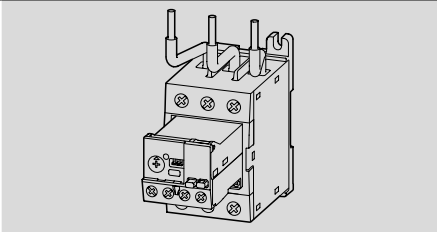
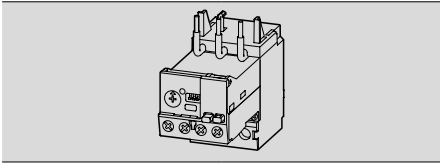

Product Selection

2

Overload release setting range	Circuit symbol	Auxiliary contact	for use with	Short-circuit protective breaker	
				Type "1" coordination gG/gL	Type "2" coordination gG/gL
I_r		N/O = normally open N/C = normally closed contact		A	A
A					

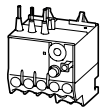

ZE overload relays for mini contactor relays

- Phase failure sensitivity to IEC/EN 60947, VDE 0660 Part 102
- Test/off button
- Reset pushbutton manual/auto
- Trip free design
- Direct mounting

Overload release setting range	Circuit symbol	Auxiliary contact	for use with	Type "1" coordination gG/gL	Type "2" coordination gG/gL
0.1 - 0.16		1 N/O	1 N/C	DILEM DIULEM/21/MV	20
0.16 - 0.24					0.5
0.24 - 0.4					1
0.4 - 0.6					2
0.6 - 1					2
1 - 1.6					4
1.6 - 2.4					6
2.4 - 4				35	6
4 - 6					10
6 - 9					
9 - 12					20

Notes

Information relevant for export to North America





Product standards	UL 508; CSA-C22.2 No. 14; IEC/EN 60947-4-1; CE marking
UL File No.	E29184
UL CCN	NKCR
CSA File No.	12528
CSA Class No.	3211-03
NA Certification	UL Listed, CSA certified
Suitable for	Branch circuits
Max. Voltage rating	600 V AC
Degree of Protection	IEC: IP20, UL/CSA type: –

Type
Article no.

Std. pack

Notes

ZE-0.16 014263	1 pc. 	Overload trigger: tripping class 10 A Short-circuit protection: With direct mounting maximum Observe the maximum permissible fuse of the contactor.
ZE-0.24 014285		
ZE-0.4 014300		Suitable for protection of Ex e-motors
ZE-0.6 014333		 II(2)G [Ex d] [Ex e] [Ex px] II(2)D [Ex p] [Ex t] PTB 10 ATEX 3014
ZE-1.0 014376		Observe manual MN03407003Z-DE/EN.
ZE-1.6 014432		
ZE-2.4 014479		
ZE-4 014518		
ZE-6 014565		
ZE-9 014708		
ZE-12 014752		

With side-by-side mounting, a minimum distance of 5 mm should be kept between the overload relays.

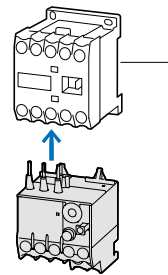

Accessories

- 1 Contactor
- Accessories
- Manual

Page

- 1/8
- 2/19
- 2/19

Bimetal relay ZB12, ZB32 to 150 A

2

Overload release setting range	Circuit symbol	Auxiliary contact N/O = normally open N/C = normally closed contact	For use with		Short circuit protection	
			Contactors	Soft starter	Type "1" coordination gG/gL	Type "2" coordination gG/gL
I_r					A	A
A						

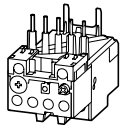

Motor-protective relay ZB12								
0.1 - 0.16		1 N/O 1 N/C	DILM7	-	25		0.5	
0.16 - 0.24			DILM9				1	
0.24 - 0.4			DILM12				2	
0.4 - 0.6			DILM15				4	
0.6 - 1			DIULM7				4	
1 - 1.6			DIULM9				6	
1.6 - 2.4			DIULM12				10	
2.4 - 4			SDAINLM12				DS7-34...SX004...	16
4 - 6			SDAINLM16				DS7-34...SX005...	20
6 - 10			SDAINLM22				DS7-34...SX007... DS7-34...SX009...	50 25
9 - 12		DS7-34...SX012...						
12 - 16		-						

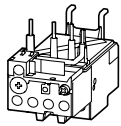

Overload relays ZB32							
0.1 - 0.16		1 N/O 1 N/C	DILM17	-	25		0.5
0.16 - 0.24			DILM25				1
0.24 - 0.4			DILM32				2
0.4 - 0.6			DILM38				4
0.6 - 1			DILMF8				4
1 - 1.6			DILMF11				6
1.6 - 2.4			DILMF14				10
2.4 - 4			DILMF17				16
4 - 6			DILMF25				20
6 - 10			DILMF32				50
10 - 16	DIULM17	DS7-34...SX016...	63	35			
16 - 24	DIULM25	DS7-34...SX024...	125	50			
24 - 32	DIULM32	DS7-34...SX032...	125	63			
32 - 38	SDAINLM30	-	125	63			
	SDAINLM45						
	SDAINLM55						

Notes

Information relevant for export to North America



Product standards IEC/EN 60947-4-1; UL 60947-4-1; CSA-C22.2 No. 60947-4-1-14; CE marking
 UL File No. E29184
 UL CCN NKCR
 CSA File No. 12528
 CSA Class No. 3211-03

NA Certification Suitable for Max. Voltage rating Degree of Protection

UL Listed, CSA certified Branch circuits 600 V AC IEC: IP20, UL/CSA type: -

Type
Article no. **Std. pack** **Notes**

ZB12-0.16 278431	1 pc. 	Overload trigger: tripping class 10 A Short-circuit protection: With direct mounting maximum Observe the maximum permissible fuse of the contactor. Suitable for protection of Ex e-motors.
ZB12-0.24 278432		
ZB12-0.4 278433		⊕ II(2)G [Ex d] [Ex e] [Ex px] II(2)D [Ex p] [Ex t]
ZB12-0.6 278434		PTB 10 ATEX 3010
ZB12-1 278435		Phase failure sensitivity to IEC/EN 60947, VDE 0660 Part 102 Test/off button Reset pushbutton manual/auto
ZB12-1.6 278436		Trip free design Direct mounting
ZB12-2.4 278437		Observe manual MN03407004Z-DE/EN.
ZB12-4 278438		
ZB12-6 278439		
ZB12-10 278440		
ZB12-12 278441		
ZB12-16 290168		

Fitted directly to the contactor

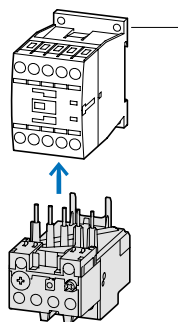

Accessories

- 1 Contactor
- Accessories
- Manual

Page

- 1/8
- 2/19
- 2/19

ZB32-0.16 278442	1 pc. 	Overload trigger: tripping class 10 A Short-circuit protection: With direct mounting maximum Observe the maximum permissible fuse of the contactor. Suitable for protection of Ex e-motors.
ZB32-0.24 278443		
ZB32-0.4 278444		⊕ II(2)G [Ex d] [Ex e] [Ex px] II(2)D [Ex p] [Ex t]
ZB32-0.6 278445		PTB 10 ATEX 3010
ZB32-1 278446		Phase failure sensitivity to IEC/EN 60947, VDE 0660 Part 102 Test/off button Reset pushbutton manual/auto
ZB32-1.6 278447		Trip free design Direct mounting
ZB32-2.4 278448		Observe manual MN03407004Z-DE/EN.
ZB32-4 278449		
ZB32-6 278450		
ZB32-10 278451		
ZB32-16 278452		
ZB32-24 278453		
ZB32-32 278454		
ZB32-38 112474		

Fitted directly to the contactor

separate mounting

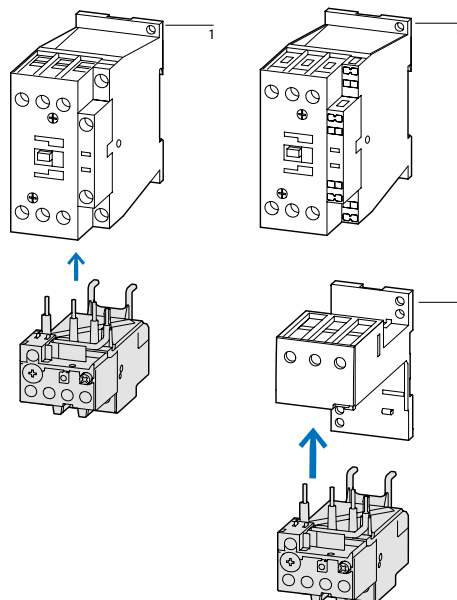

Accessories



- 1 Contactor
- 2 Plinth
- Manual

Page

- 1/27
- 2/19
- 2/19

Bimetal relay ZB65, ZB150 to 150 A

2

Overload release setting range	Circuit symbol	Auxiliary contact	For use with	Short circuit protection	
		N/O = normally open N/C = normally closed contact		Type "1" coordination gG/gL	Type "2" coordination gG/gL
I_r				A	A
A					

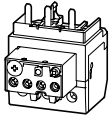

Motor-protective relay ZB65

- Phase failure sensitivity to IEC/EN 60947, VDE 0660 Part 102
- Test/off button
- Reset pushbutton manual/auto
- Trip free design
- Direct mounting

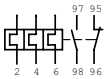
Setting range	Circuit symbol	1 N/O	1 N/C	For use with	Type "1" coordination gG/gL	Type "2" coordination gG/gL
6 - 10				DILM40	50	25
10 - 16				DILM50 DILM65 DILM72	63	35
16 - 24				DILMF40 DILMF50 DILMF65	63	50
24 - 40				DIULM40 DIULM50 DIULM65	125	63
40 - 57				SDAINLM70 SDAINLM90	160	80
50 - 65				SDAINLM115	160	100
65 - 75					200	125

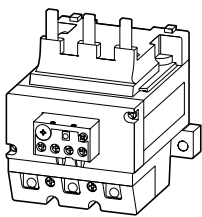

Overload relay ZB150 – direct mounting

- Phase failure sensitivity to IEC/EN 60947, VDE 0660 Part 102
- Test/off button
- Reset pushbutton manual/auto
- Trip free design

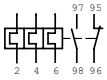
Setting range	Circuit symbol	1 N/O	1 N/C	For use with	Type "1" coordination gG/gL	Type "2" coordination gG/gL
25 - 35				DILM80	125	100
35 - 50				DILM95 DILM115 DILM150 DILM170	160	125
50 - 70				DILMF80 DILMF95	250	160
70 - 100				DILMF115 DILMF150	315	200
95 - 125				DIULM80 DIULM95 DIULM115	315	250
120 - 150				DIULM150	315	250
145 - 175				SDAINLM140 SDAINLM165 SDAINLM200 SDAINLM260	315	250

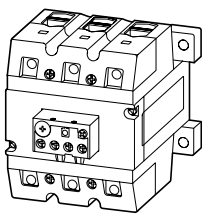



Overload relay ZB150 – separate mounting

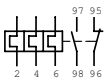

- Phase failure sensitivity to IEC/EN 60947, VDE 0660 Part 102
- Test/off button
- Reset pushbutton manual/auto
- Trip free design

Setting range	Circuit symbol	1 N/O	1 N/C	For use with	Type "1" coordination gG/gL	Type "2" coordination gG/gL
25 - 35				DILM80	125	100
35 - 50				DILM95 DILM115 DILM150 DILM170	160	125
50 - 70				DILMF80 DILMF95	250	160
70 - 100				DILMF115 DILMF150	315	200
95 - 125				DIULM80 DIULM95 DIULM115	315	250
120 - 150				DIULM150	315	250
145 - 175				SDAINLM140 SDAINLM165 SDAINLM200 SDAINLM260	400	315

Type Std. pack Notes
Article no.

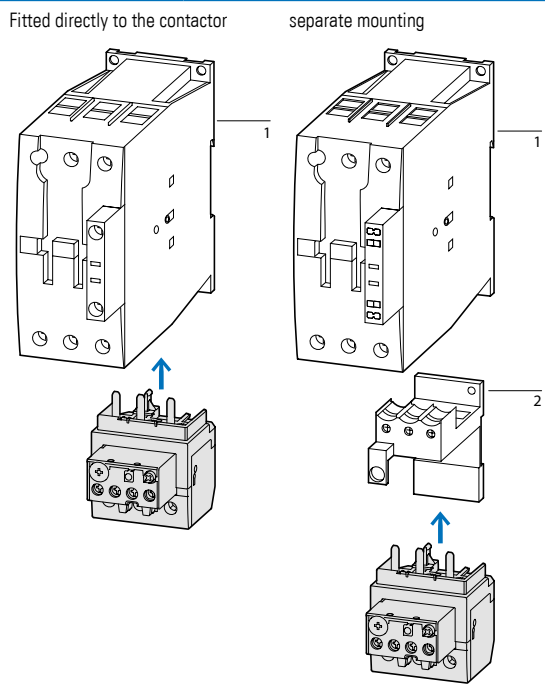
ZB65-10 278455	1 pc.  	Overload trigger: tripping class 10 A Short-circuit protection: With direct mounting maximum Observe the maximum permissible fuse of the contactor.
ZB65-16 278456		Suitable for protection of Ex e-motors.
ZB65-24 278457		 II(2)G [Ex d] [Ex e] [Ex px] II(2)D [Ex p] [Ex t] PTB 10 ATEX 3010
ZB65-40 278458		Observe manual MN03407005Z-DE/EN.
ZB65-57 278459		
ZB65-65 278460		
ZB65-75 108792		no ATEX classification





ZB150-35 278461	1 pc.  	Overload trigger: tripping class 10 A Short-circuit protection: With direct mounting maximum Observe the maximum permissible fuse of the contactor.
ZB150-50 278462		Suitable for protection of Ex e-motors.
ZB150-70 278463		 II(2)G [Ex d] [Ex e] [Ex px] II(2)D [Ex p] [Ex t] PTB 10 ATEX 3010
ZB150-100 278464		Observe manual MN03407005Z-DE/EN.
ZB150-125 278465		
ZB150-150 278466		
ZB150-175 107316		no ATEX classification

Accessories

- 1 Contactor
- 2 Plinth
- Manual

Page

- 1/26
- 2/19
- 2/19

ZB150-35/KK 278467	1 pc.  	Overload trigger: tripping class 10 A Short-circuit protection: With direct mounting maximum Observe the maximum permissible fuse of the contactor.
ZB150-50/KK 278468		Suitable for protection of Ex e-motors.
ZB150-70/KK 278469		 II(2)G [Ex d] [Ex e] [Ex px] II(2)D [Ex p] [Ex t] PTB 10 ATEX 3010
ZB150-100/KK 278470		Observe manual MN03407005Z-DE/EN.
ZB150-125/KK 278471		
ZB150-150/KK 278472		
ZB150-175/KK 107317		no ATEX classification

Information relevant for export to North America



Product standards	IEC/EN 60947-4-1; UL 60947-4-1; CSA-C22.2 No. 60947-4-1-14; CE marking
UL File No.	E29184
UL CCN	NKCR
CSA File No.	12528
CSA Class No.	3211-03
NA Certification	UL Listed, CSA certified
Suitable for	Branch circuits
Max. Voltage rating	600 V AC
Degree of Protection	IEC: IP00, UL/CSA type: –

Bimetal relay Z5 to 300 A, transformer relay ZW7

2

Overload release setting range	Circuit symbol	Auxiliary contact	For use with	Short circuit protection	
		N/O = normally open N/C = normally closed contact		Type "1" coordination gG/gL	Type "2" coordination gG/gL
I_r A				A	A

Overload relay Z5

- Phase failure sensitivity to IEC/EN 60947, VDE 0660 Part 102
- Test/off button
- Reset pushbutton manual/auto
- Trip free design
- Direct mounting
- separate mounting

	50 - 70		1 N/O	1 N/C	DILM185A DILM225A	250 (DILM185A) 250 (DILM225A)	160 (DILM185A) 160 (DILM225A)
	70 - 100		315 (DILM185A) 315 (DILM225A)	200 (DILM185A) 200 (DILM225A)			
	95 - 125		315 (DILM185A) 315 (DILM225A)	250 (DILM185A) 250 (DILM225A)			
	120 - 160		400 (DILM185A) 400 (DILM225A)	250 (DILM185A) 250 (DILM225A)			
	160 - 220		400 (DILM185A) 500 (DILM225A)	315 (DILM185A) 400 (DILM225A)			
	200 - 250		500 (DILM185A) 500 (DILM225A)	500 (DILM185A) 500 (DILM225A)			
	50 - 70				DILM250	250	160
	70 - 100				315	200	
	95 - 125				315	250	
	120 - 160				400	250	
	160 - 220			DILM250 DILM300A	400 (DILM250) 500 (DILM300A)	315 (DILM250) 400 (DILM300A)	
	200 - 250				500 (DILM250) 500 (DILM300A)	500 (DILM250) 500 (DILM300A)	
200 - 300				DILM300A	630	630	

Current transformer-operated relay ZW7

- Test/off button
- Reset pushbutton manual/auto
- Trip free design
- Protection with heavy starting duty
- separate mounting

	42 - 63		1 N/O	1 N/C			
	60 - 90						
	85 - 125						
	110 - 160						
	160 - 240						
	190 - 290						
	270 - 400						
	360 - 540						
	420 - 630						

Type
Article no.

Std. pack

Notes

Information relevant for export to North America



Z5-70/FF225A 139572	1 pc. 	Overload trigger: tripping class 10 A Short-circuit protection: With direct mounting maximum Observe the maximum permissible fuse of the contactor. Fitted directly to the contactor		Product standards IEC/EN 60947-4-1; UL 60947-4-1; CSA-C22.2 No. 60947-4-1-14; CE marking UL File No. E29184 UL CNN NKCR CSA File No. 12528 CSA Class No. 3211-03 NA Certification UL listed, CSA certified Suitable for Branch circuits Max. Voltage rating 600 V AC Degree of Protection IEC: IP00, UL/CSA type: –
Z5-100/FF225A 139573				
Z5-125/FF225A 139574				
Z5-160/FF225A 139575				
Z5-220/FF225A 139576				
Z5-250/FF225A 139577				
Z5-70/FF250 210070				
Z5-100/FF250 210071				
Z5-125/FF250 210072				
Z5-160/FF250 210073				
Z5-220/FF250 210074				
Z5-250/FF250 210075				
Z5-300/FF250 139578				

Accessories	Page
1 Contactor	→ 1/24
Accessories	→ 2/20

ZW7-63 000245	1 pc. 	The main current characteristics are defined by the main current wiring used. Adaptation to lower rated motor currents → page 2/21	Product standards UL 508; CSA-C22.2 No. 14; IEC/EN 60947-4-1; CE marking UL File No. E29184 UL CCN NKCR CSA File No. 12528 CSA Class No. 3211-03 NA Certification UL Listed, CSA certified Suitable for Branch circuits Max. Voltage rating 600 V AC Degree of Protection IEC: IP00, UL/CSA type: –		
ZW7-90 002618					
ZW7-125 004991					
ZW7-160 007364					
ZW7-240 009737					
ZW7-290 052448					
ZW7-400 045329					
ZW7-540 047702					
ZW7-630 050075				1 pc.	–

Electronic overload relay ZEB12, ZEB32 to 175 A

2

Earth fault detection	Settings range Overload trigger	Circuit symbol	Auxiliary contact	For use with
			N/O = normally open N/C = normally closed contact	

I_r

A



ZEB electronic overload relay12

- Phase failure sensitivity to IEC/EN 60947, VDE 0660 Part 102
- Test/off button
- Reset pushbutton
- Manual/auto reset selectable
- Protection for heavy starting duty (CLASS 10A to CLASS 30 or CLASS 10, CLASS 20 for earth fault detection)

Direct mounting

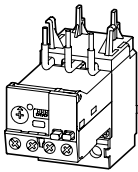

None	0.33 - 1.65		1 N/O	1 N/C	DILM7 DILM9 DILM12 DILM15 DIULM7 DIULM9 DIULM12 SDAINLM12 SDAINLM16 SDAINLM22
with	0.33 - 1.65				
without	1 - 5				
with	1 - 5				
without	4 - 20				
with	4 - 20				

ZEB electronic overload relay32

- Phase failure sensitivity to IEC/EN 60947, VDE 0660 Part 102
- Test/off button
- Reset pushbutton
- Manual/auto reset selectable
- Protection for heavy starting duty (CLASS 10A to CLASS 30 or CLASS 10, CLASS 20 for earth fault detection)

Direct mounting

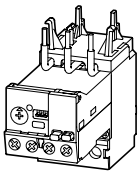



without	0.33 - 1.65		1 N/O	1 N/C	DILM17 DILM25 DILM32 DILM38 DIULM17 DIULM25 DIULM32 SDAINLM30 SDAINLM45 SDAINLM55
with	0.33 - 1.65				
without	1 - 5				
with	1 - 5				
without	4 - 20				
with	4 - 20				
without	9 - 45				
with	9 - 45				

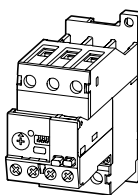





separate mounting

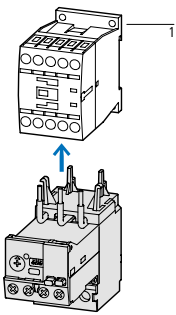

without	0.33 - 1.65		1 N/O	1 N/C	DILM17 DILM25 DILM32 DILM38 DIULM17 DIULM25 DIULM32 SDAINLM30 SDAINLM45 SDAINLM55
with	0.33 - 1.65				
without	1 - 5				
with	1 - 5				
without	4 - 20				
with	4 - 20				
without	9 - 45				
with	9 - 45				

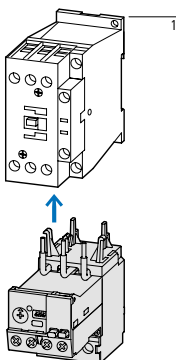
Type Std. pack Notes
Article no.

Type	Std. pack	Notes	Fitted directly to the contactor
ZEB12-1.65 136480	1 pc.  	Switchgear and cable sizing corresponding to the respective starting inertia (CLASS) → Engineering, page 2/18	
ZEB12-1.65-GF 136483			
ZEB12-5 136481			
ZEB12-5-GF 136484			
ZEB12-20 136482			
ZEB12-20-GF 136485			
			<p>Accessories</p> <p>1 Contactor → 1/24</p> <p>Accessories → 2/18</p>

ZEB32-1.65 136486	1 pc.  	Switchgear and cable sizing corresponding to the respective starting inertia (CLASS) → Engineering, page 2/18																			
ZEB32-1.65-GF 136490																					
ZEB32-5 136487																					
ZEB32-5-GF 136491																					
ZEB32-20 136488																					
ZEB32-20-GF 136492																					
ZEB32-45 136489																					
ZEB32-45-GF 136493																					
ZEB32-1.65/KK 136494	1 pc.  	Switchgear and cable sizing corresponding to the respective starting inertia (CLASS) → Engineering, page 2/18	<p>Accessories</p> <p>1 Contactor → 1/24</p> <p>Accessories → 2/18</p> <p>Information relevant for export to North America</p>   <table border="0"> <tr> <td>Product standards</td> <td>UL 508; CSA-C22.2 No. 14; IEC/EN 60947-4-1; CE marking</td> </tr> <tr> <td>UL File No.</td> <td>E1230</td> </tr> <tr> <td>UL CCN</td> <td>NKCR</td> </tr> <tr> <td>CSA File No.</td> <td>2290956</td> </tr> <tr> <td>CSA Class No.</td> <td>3211-03</td> </tr> <tr> <td>NA Certification</td> <td>UL listed, CSA certified</td> </tr> <tr> <td>Suitable for</td> <td>Branch circuits</td> </tr> <tr> <td>Max. Voltage rating</td> <td>600 V AC</td> </tr> <tr> <td>Degree of Protection</td> <td>IEC: IP20, UL/CSA type: –</td> </tr> </table>	Product standards	UL 508; CSA-C22.2 No. 14; IEC/EN 60947-4-1; CE marking	UL File No.	E1230	UL CCN	NKCR	CSA File No.	2290956	CSA Class No.	3211-03	NA Certification	UL listed, CSA certified	Suitable for	Branch circuits	Max. Voltage rating	600 V AC	Degree of Protection	IEC: IP20, UL/CSA type: –
Product standards	UL 508; CSA-C22.2 No. 14; IEC/EN 60947-4-1; CE marking																				
UL File No.	E1230																				
UL CCN	NKCR																				
CSA File No.	2290956																				
CSA Class No.	3211-03																				
NA Certification	UL listed, CSA certified																				
Suitable for	Branch circuits																				
Max. Voltage rating	600 V AC																				
Degree of Protection	IEC: IP20, UL/CSA type: –																				
ZEB32-1.65-GF/ KK 136498																					
ZEB32-5/KK 136495																					
ZEB32-5-GF/KK 136499																					
ZEB32-20/KK 136496																					
ZEB32-20-GF/KK 136500																					
ZEB32-45/KK 136497																					
ZEB32-45-GF/KK 136501																					

Electronic overload relay ZEB65, ZEB150, ZEB225 to 175 A

Earth fault detection Settings range
Overload trigger Circuit symbol Auxiliary contact For use with

N/O = normally open
N/C = normally closed
contact

I_r
A



ZEB electronic overload relay65

- Phase failure sensitivity to IEC/EN 60947, VDE 0660 Part 102
- Test/off button
- Reset pushbutton
- Manual/auto reset selectable
- Protection for heavy starting duty (CLASS 10A to CLASS 30 or CLASS 10 to CLASS 20 for earth fault detection)

Direct mounting

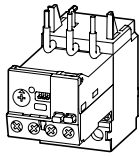

without	9 - 45		1 N/O	1 N/C	DILM40 DILM50 DILM65 DILM72 DIULM40 DIULM50 DIULM65
with	9 - 45		SDAINLM70 SDAINLM90 SDAINLM115		
without	20 - 100				
with	20 - 100				

Electronic overload relay ZEB150, ZEB225

- Phase failure sensitivity to IEC/EN 60947, VDE 0660 Part 102
- Test/off button
- Reset pushbutton
- Manual/auto reset selectable
- Protection for heavy starting duty (CLASS 10A to CLASS 30 or CLASS 10 to CLASS 20 for earth fault detection)

Direct mounting

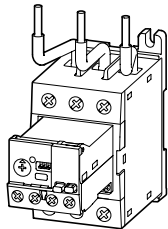

without	20 - 100		1 N/O	1 N/C	DILM80, DILM95, DILM115, DILM150, DIULM80, DIULM95, DIULM115, DIULM150, SDAINLM140, SDAINLM165, SDAINLM200, SDAINLM260
with					
without	35 - 175				DILM80, DILM95, DILM115, DILM150, DILM170, DIULM80, DIULM95, DIULM115, DIULM150, SDAINLM140, SDAINLM165, SDAINLM200, SDAINLM260
with					
without					DILM185A, DILM225A
with					

separate mounting

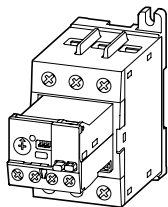

without	20 - 100		1 N/O	1 N/C	DILM80, DILM95, DILM115, DILM150, DIULM80, DIULM95, DIULM115, DIULM150, SDAINLM140, SDAINLM165, SDAINLM200, SDAINLM260
with					
without	35 - 175				DILM80, DILM95, DILM115, DILM150, DILM170, DIULM80, DIULM95, DIULM115, DIULM150, SDAINLM140, SDAINLM165, SDAINLM200, SDAINLM260
with					

Type
Article no. **Std. pack** **Notes**

ZEB65-45
136502
ZEB65-45-GF
136503
ZEB65-100
136504
ZEB65-100-GF
136505

1 pc.

Switchgear and cable sizing corresponding to the respective starting inertia (CLASS)
→ Engineering, page 2/18

Fitted directly to the contactor

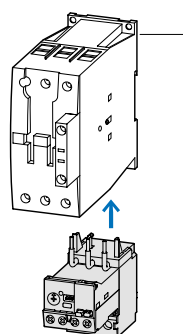

Accessories
1 Contactor
Accessories

Page
→ 1/24
→ 2/18

ZEB150-100
136506
ZEB150-100-GF
136507
ZEB150-175
164303
ZEB150-175-GF
164304
ZEB225-175
164307
ZEB225-175-GF
164308

1 pc.

Switchgear and cable sizing corresponding to the respective starting inertia (CLASS)
→ Engineering, page 2/18

Fitted directly to the contactor

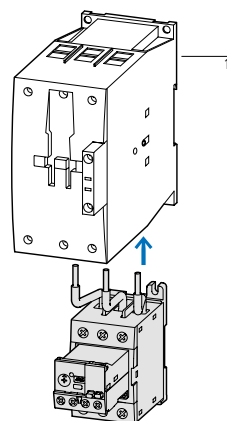

Accessories
1 Contactor
Accessories

Page
→ 1/24
→ 2/18

ZEB150-100/KK
136508
ZEB150-100-GF/KK
136509
ZEB150-175/KK
164305
ZEB150-175-GF/KK
164306

1 pc.

Switchgear and cable sizing corresponding to the respective starting inertia (CLASS)
→ Engineering, page 2/18

Information relevant for export to North America





Product standards	UL 508; CSA-C22.2 No. 14; IEC/EN 60947-4-1; CE marking
UL File No.	E1230
UL CCN	NKCR
CSA File No.	2290956
CSA Class No.	3211-03
NA Certification	UL listed, CSA certified
Suitable for	Branch circuits
Max. Voltage rating	600 V AC
Degree of Protection	IEC: IP20, UL/CSA type: –

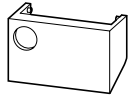

Type	Std. pack
Article no.	
Sealable shroud	
Covering cap for motor current setting (tamper-proofed)	
ZEB-XSC 136514	1 pc.  



Reset adapters	
To enlarge the reset	
ZEB-XRB 136515	1 pc.  

Notes	Information relevant for export to North America
	 
Product standards	UL 508; CSA-C22.2 No. 14; IEC/EN 60947-4-1; CE marking
NA Certification	Request filed for UL and CSA
Max. Voltage rating	600 V AC
Degree of Protection	IEC: IP20, UL/CSA type: –

Engineering













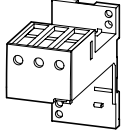

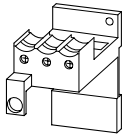

Switchgear and cable sizing corresponding to the respective starting inertia (CLASS) for ZEB

The switchgear is designed for CLASS 10 in normal and overload operation. To ensure that the switchgear (circuit-breaker and contactor) as well as the cables are not overloaded with extended tripping times, they must be over-dimensioned accordingly.

The rated operational current I_b for switchgear and cables can be calculated with the following current factor while taking the tripping class into account:

Tripping class	CLASS 5	CLASS 10	CLASS 15	CLASS 20	CLASS 25	CLASS 30	CLASS 35	CLASS 40
Current factor for rated operational current I_b	1.00	1.00	1.22	1.41	1.58	1.73	1.89	2.00

Product Selection

For use with	Type Article no.	Std. pack	Notes	Information relevant for export to North America	
					
Base					
For separate mounting					
	ZB32-XEZ 278473	5 pcs.  	Can be snap fitted on a top-hat rail to IEC/EN 60715 or can be screw fitted. For ZB32-38 use additional contactor BK25/3-PKZ0.	Product standards UL File No. UL CCN CSA File No. CSA Class No. NA Certification Max. Voltage rating Degree of Protection	UL 508; CSA-C22.2 No. 14; IEC/EN 60947-4-1; CE marking E29184 NKCR 12528 3211-03 UL Listed, CSA certified 600 V AC IEC: IP20, UL/CSA type: –
	ZB65-XEZ 278474	2 pcs.  			
Pushbuttons					
For enclosed overload relay Mounting hole diameter: 22.3 mm					
	M22-DZ-B 254833	10 pcs.  	Button plate, blue	Product standards UL File No. UL CCN CSA File No. CSA Class No. NA Certification	UL 508; CSA-C22.2 No. 14; IEC/EN 60947; CE marking E29184 NKCR 012528 3211-03 UL Listed, CSA certified
	M22-DZ-B-GB14 254834		Button plate blue RESET		
	M22-DZ-X 254835	10 pcs.  	Without button plate, add button plate.	Product standards UL File No. UL CCN CSA File No. CSA Class No. NA Certification	UL 508; CSA-C22.2 No. 14; IEC/EN 60947; CE marking E29184 NKCR 012528 3211-03 UL Listed, CSA certified
	M22-XD-R 216423	10 pcs.  	Button plate, red	Product standards UL File No. UL CCN CSA File No. CSA Class No. NA Certification	UL 508; CSA-C22.2 No. 14; IEC/EN 60947; CE marking E29184 NKCR 012528 3211-03 UL Listed, CSA certified
	M22-XD-R-X0 218153		Red button plate with white circle		
	M22-XD-R-GB0 218194		Button plate red STOP		
	Documentation				
Motor protection relay Overload monitoring of Ex e motors					
ZE	MN03407003Z-DE/EN 151981	1 pc.	Language: German/English		
ZB12... ZB32...	MN03407004Z-DE/EN 151980				
ZB65... ZB150...	MN03407005Z-DE/EN 151987				

Covers Z5/FF

2

For use with **Type** Std. pack **Notes**
Article no.

Covers

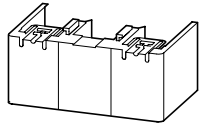

Direct mounting Z5-.../FF225 to
DILM185A
DILM225A

Z5/FF225A-XHB-Z
139579

1 pc.

Fitted directly to the contactor

- DILM225A-XHB
- DILM185A/225A
- Z5/FF225A-XHB-Z
- Z5-.../FF225A
- DILM225A-XHB

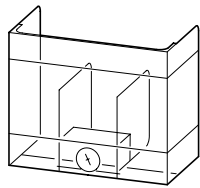

Z5-.../FF225A
Z5-.../FF250

Z5/FF250-XHB
215217

1 pc.

Separate mounting

Fitted directly to the contactor

Fitted directly to the contactor

- Z5/FF250-XHB
- Z5-.../FF250/FF225A
- Z5/FF250-XHB

- DILM400-XHB
- DILM250/300A
- Z5/FF250-XHB-Z
- Z5-.../FF250
- Z5/FF250-XHB

- DILM225A-XHB
- DILM185A/225A
- Z5/FF225A-XHB-Z
- Z5-.../FF225A
- DILM225A-XHB

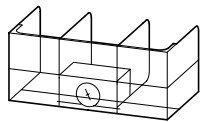

Direct mounting Z5-.../FF250 to
DILM250
DILM300A

Z5/FF250-XHB-Z
215218

1 pc.

Fitted directly to the contactor

- DILM400-XHB
- DILM250/300A
- Z5/FF250-XHB-Z
- Z5-.../FF250
- Z5/FF250-XHB

Cross-section x number of cores

Type
Article no.

Std. pack

mm²

Cable terminal set

Consisting of 3 individual clamps

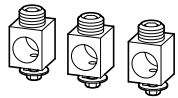

Z5-.../FF250
Z5-.../FF250A

1 x (AWG6 ... MCM350)

Z5-FF250-XK-CNA
229314

1 pc.

Engineering

Protection of single-phase and DC current motors

1-pole

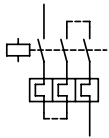

2-pole

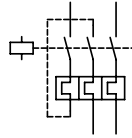

Mounting position

ZE

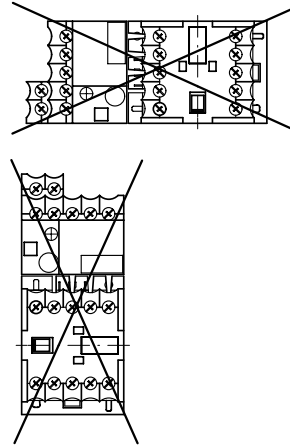

ZB12, ZB32, ZB65, ZB150, Z5

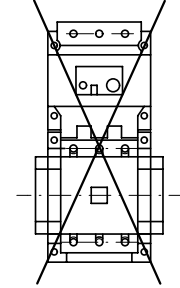

Tripping characteristics

These tripping characteristics of bimetal relays are mean values of the spread at 20 °C ambient air temperature in a cold state. Tripping time depends on response current. In the case of devices at operating temperature, the tripping time of the overload relay decreases to around 25% of the value that is read off. Specific characteristics for each individual setting range can be found in the manual → page 2/19

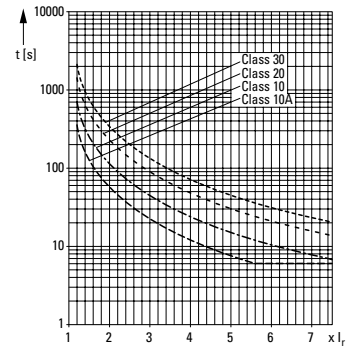
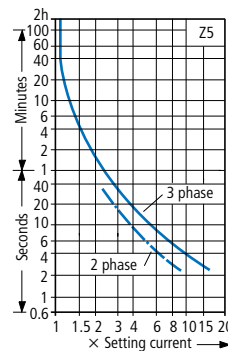
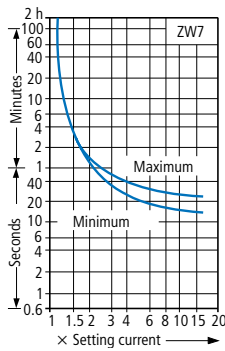
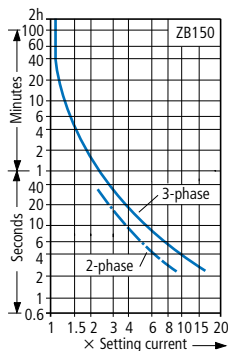
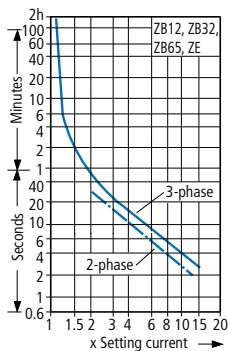

Adaptation to lower rated motor currents at ZW7

Number of loops	ZW7-63	ZW7-90	ZW7-125	ZW7-160	ZW7-240	ZW7-290	ZW7-400	ZW7-540	ZW7-630
	Rated motor current I_N [A]								
1	42 - 63	60 - 90	85 - 125	110 - 160	160 - 240	190 - 290	270 - 400	360 - 540	420 - 630
2	21 - 31.5	30 - 45	42.5 - 62.5	55 - 80	80 - 120	95 - 145			
3	14 - 21	20 - 30	28.3 - 41.7	36.7 - 53.3					
4	10.5 - 15.8	15 - 22.5							
5	8.4 - 12.6								

Technical data

2

		ZE	ZB12 ZB32	ZB65	ZB150(KK)
General					
Standards		IEC/EN 60947, VDE 0660, UL, CSA			
Climatic proofing		Damp heat, constant, to IEC 60068-2-78 Damp heat, cyclic, to IEC 60068-2-30			
Ambient temperature					
Open ¹⁾	°C	-25 - 50	-25 - 55	-25 - 55	-25 - 55
Enclosed ¹⁾	°C	-25 - 40	-25 - 40	-25 - 40	-25 - 40
Temperature compensation		Continuous			
Mounting position		→ page 2/21			
Weight		→ Data sheet in online catalog			
Mechanical shock resistance half-sinusoidal shock 10 ms to IEC 60068-2-27	g	10	10	10	10
Protection rating		IP20	IP20	IP00	IP00
Busbar tag shroud when actuated from front (EN 50274)		Finger- and back-of-hand proof			
Main circuits					
Rated impulse withstand voltage	U_{imp} V AC	6000	6000	6000	8000
Overvoltage category/degree of pollution		III/3	III/3	III/3	III/3
Rated insulation voltage	U_i V AC	690	690	690	1000
Rated operating voltage	U_e V AC	690	690	690	1000
Safe isolation according to EN 61140					
Between auxiliary contacts and main contacts	V AC	300	440	440	440
Between the main contacts	V AC	300	440	440	440
Overload relay setting range	A	0.1 - 12	0.1 - 38	6 - 75	25 - 175
Temperature compensation residual error > 40 °C	%/K	≤ 0.25	≤ 0.25	≤ 0.25	≤ 0.25
Short-circuit protection max. Fuse		→ 2/6	→ 2/8	→ 2/10	→ 2/10
Current heat loss (3 conductors)					
Lower value of setting range		→ Data sheet in online catalog			
Upper value of setting range					
Terminal capacity					
Solid	mm ²	1 x (0.75 - 2.5)	1 x (1 - 6) 2 x (1 - 6)	1 x (1 - 16) 2 x (1 - 16)	1 x (4 - 16) 2 x (4 - 16)
Flexible with ferrule	mm ²	1 x (0.5 - 1.5)	1 x (1 - 4) 2 x (1 - 4)	1 x (1 - 25) 2 x (1 - 25)	1 x (4 - 70) 2 x (4 - 70)
Stranded	mm ²	–	–	1 x (16 - 25)	1 x (16 - 70) 2 x (16 - 70)
Solid or stranded	AWG	18 - 14	18 - 8	14 - 2	3/0
Terminal Screw		M3.5	M4	M6	M10
Tightening torque	Nm	1.2	1.8 ²⁾	3.5	10
Tools					
Pozidriv screwdriver	Size	2	2	2	–
Standard screwdriver	mm	0.8 x 5.5	1 x 6	1 x 6	–
Hexagon socket-head screw	SW mm	–	–	–	5
Notes					
¹⁾ ambient air temperature: Operating range to IEC/EN 60947, PTB: -5 °C to +55 °C					
²⁾ ZB32-38 solid and flexible with ferrule 2.5 - 25 mm ² , tightening torque 3 Nm. AWG 10-6, tightening torque 27 lb-in for solid or stranded cables.					

	Z5-.../FF225A(250)		ZW7
General			
Standards	IEC/EN 60947, VDE 0660, UL, CSA		IEC/EN 60947, VDE 0660, UL, CSA ¹⁾
Climatic proofing	Damp heat, constant, to IEC 60068-2-78 Damp heat, cyclic, to IEC 60068-2-30		
Ambient temperature			
Open ²⁾	°C	-25 - 60	-25 - 50
Enclosed ²⁾	°C	-25 - 40	-25 - 40
Temperature compensation	Continuous		Continuous
Mounting position	→ page 2/21		Any
Weight	kg	1.55	0.8
Mechanical shock resistance half-sinusoidal shock 10 ms to IEC 60068-2-27	g	10	10
Protection rating	IP00		IP00
Busbar tag shroud when actuated from front (EN 50274)	With terminal cover		Finger- and back-of-hand proof
Main circuits			
Rated impulse withstand voltage	U_{imp}	V AC	8000
Overvoltage category/degree of pollution			III/3
Rated insulation voltage	U_i	V AC	1000
Rated operating voltage	U_e	V AC	1000
Safe isolation according to EN 61140			
Between auxiliary contacts and main contacts	V AC		500
Between the main contacts	V AC		500
Overload relay setting range	A	50 - 300	42 - 630
Temperature compensation residual error > 40 °C	%/K	≤ 0.25	–
Short-circuit protection max. Fuse	→ page 2/12		With overload relay in conjunction with a transformer as required for the contactor
Current heat loss (3 conductors)			
Lower value of setting range	W	→ Data sheet in online catalog	
Upper value of setting range	W	10	
Terminal capacities			
Flexible with cable lug	mm ²	185	–
Stranded with cable lug	mm ²	185	–
Solid or stranded	AWG	500 MCM	→ Data sheet in online catalog
Busbar	Width	mm	25
Push-through opening	∅	mm	–
Terminal Screw			M10 x 35
Tightening torque	Nm	18	1.2
Tools			
Hexagon	SW	mm	16

Notes¹⁾ ZW7-630: not UL, CSA approved²⁾ ambient air temperature: Operating range to IEC/EN 60947, PTB: -5 °C to +50 °C

			ZE	ZB12 ZB32	ZB65	ZB150(KK)	Z5-.../FF225 Z5-.../FF250	ZW7
Auxiliary and actuating circuits								
Rated impulse withstand voltage	U_{imp}	V	4000	4000	4000	4000	4000	4000
Overvoltage category/degree of pollution			III/3	III/3	III/3	III/3	III/3	III/3
Terminal capacity								
Solid		mm ²	1 x (0.75 - 2.5) 2 x (0.75 - 2.5)	1 x (0.75 - 4) 2 x (0.75 - 4)	1 x (0.75 - 4) 2 x (0.75 - 4)	1 x (0.75 - 4) 2 x (0.75 - 4)	1 x (0.75 - 4) 2 x (0.75 - 4)	1 x (0.75 - 4) 2 x (0.75 - 4)
Flexible with ferrule		mm ²	1 x (0.5 - 1.5) 2 x (0.5 - 1.5)	1 x (0.75 - 2.5) 2 x (0.75 - 2.5)	1 x (0.75 - 2.5) 2 x (0.75 - 2.5)	1 x (0.75 - 2.5) 2 x (0.75 - 2.5)	1 x (0.75 - 2.5) 2 x (0.75 - 2.5)	1 x (0.75 - 2.5) 2 x (0.75 - 2.5)
Solid or stranded		AWG	2 x (18 - 12)	2 x (18 - 14)	2 x (18 - 14)	2 x (18 - 14)	2 x (18 - 14)	2 x (18 - 14)
Terminal Screw			M3.5	M3.5	M3.5	M3.5	M3.5	M3.5
Tightening torque		Nm	1.2	1.2	1.2	1.2	1.2	1.2
Stripping length		mm	8	8	8	8	8	8
Tools								
Pozidriv screwdriver		Size	2	2	2	2	2	2
Standard screwdriver		mm	0.8 x 5.5	1 x 6	1 x 6	1 x 6	1 x 6	1 x 6
Auxiliary circuit rated insulation voltage	U_i	V AC	500	500	500	500	500	500
Rated operating voltage	U_e	V AC	500	500	500	500	500	500
Safe isolation in accordance with EN 61140 between the auxiliary contacts		V AC	250	240	240	240	240	240
Conventional thermal current	I_{th}	A	6	6	6	6	6	6
Rated operational current								
AC-15								
N/O								
120 V	I_e	A	1.5	1.5	1.5	1.5	1.5	1.5
220 V 230 V 240 V	I_e	A	1.5	1.5	1.5	1.5	1.5	1.5
380 V 400 V 415 V	I_e	A	0.7	0.5	0.5	0.5	0.5	0.5
500 V	I_e	A	0.5	0.5	0.5	0.5	0.5	0.5
N/C								
120 V	I_e	A	1.5	1.5	1.5	1.5	1.5	1.5
220 V 230 V 240 V	I_e	A	1.5	1.5	1.5	1.5	1.5	1.5
380 V 400 V 415 V	I_e	A	0.7	0.9	0.9	0.9	0.9	0.9
500 V	I_e	A	0.5	0.8	0.8	0.8	0.8	0.8
DC L/R ≤ 15 ms ¹⁾								
24 V	I_e	A	0.9	0.9	0.9	0.9	0.9	0.9
60 V	I_e	A	0.75	0.75	0.75	0.75 ³⁾	0.75	0.75
110 V	I_e	A	0.4	0.4	0.4	0.4	0.4	0.4
220 V	I_e	A	0.2	0.2	0.2	0.2	0.2	0.2
General Use ²⁾								
AC		V	240 600	–	–	–	–	–
AC		A	1.5 0.6	–	–	–	–	–
DC		V	–	–	–	–	–	–
DC		A	–	–	–	–	–	–
Pilot duty								
AC			D300	B300 ⁴⁾ B600 ⁵⁾	B300 ⁴⁾ B600 ⁵⁾	B300 ⁴⁾ B600 ⁵⁾	B300 ⁴⁾ B600 ⁵⁾	B300 ⁴⁾ B600 ⁵⁾
DC			R300	R300	R300	R300	R300	R300
Short-circuit strength without welding								
max. Fuse		A gG/gL	4	6	6	6	6	6

Notes

¹⁾ Switch-on and switch-off conditions based on DC-13, time constant as specified

²⁾ Refer to the online catalog for further approved rating data.

³⁾ Rated operational current DC-13, 60 V: Auxiliary NO 0.6 A

⁴⁾ At opposite polarity

⁵⁾ At same polarity

	Basic Rating		
	SCCR	max. Fuse	Max. CB ¹⁾
	kA	A	A
ZE-0.16	5	1	15
ZE-0.24	5	1	15
ZE-0.4	5	1	15
ZE-0.6	5	1	15
ZE-1.0	5	3	15
ZE-1.6	5	6	15
ZE-2.4	5	6	15
ZE-4	5	15	15
ZE-6	5	20	15
ZE-9	5	35	15
ZE-12	5	45	16
ZB32-38	5	150	-
ZB65-10	5	40	40
ZB65-16	5	60	60
ZB65-24	5	90	90
ZB65-40	5	125	125
ZB65-57	10	200	150
ZB65-65	10	200	150
ZB65-75	10	200	150
ZB150-35	5	125	125
ZB150-50	5	225	200
ZB150-70	10	250	250
ZB150-100	10	400 Class J	400
ZB150-125	10	500 Class J	500
ZB150-150	10	600 Class J	600
ZB150-175	10	600 Class K5	600
ZB150-35/KK	5	60 Class J	
ZB150-50/KK	5	110 Class J	
ZB150-70/KK	10	125 Class J	
ZB150-100/KK	10	200 Class J	
ZB150-125/KK	10	250 Class J	
ZB150-150/KK	10	300 Class J	
ZB150-175/KK	10	300 Class J	
Z5-70	10	250	250
Z5-100	10	400 Class J	400
Z5-125	10	500 Class J	500
Z5-160	10	600 Class J	600
Z5-220	10	800 Class L	800
Z5-250	18	1200 Class L	1200
Z5-300	18	1200 Class L	1200

¹⁾ at ZE-...: CB for max. 480 V

	480 V High Fault				600 V High Fault	
	SCCR (fuse)	max. Fuse	SCCR (CB)	max. CB	SCCR (fuse)	max. Fuse
	kA	A	kA	A	kA	A
ZB12(32)-0.16	-	-	-	-	100	1 Class J/CC
ZB12(32)-0.24	-	-	-	-	100	1 Class J/CC
ZB12(32)-0.4	-	-	-	-	100	1 Class J/CC
ZB12(32)-0.6	-	-	-	-	100	1 Class J/CC
ZB12(32)-1	-	-	-	-	100	1 Class J/CC
ZB12(32)-1.6	-	-	-	-	100	3 Class J/CC
ZB12(32)-2.4	-	-	-	-	100	3 Class J/CC
ZB12(32)-4	-	-	-	-	100	6 Class J/CC
ZB12(32)-6	-	-	-	-	100	10 Class J/CC
ZB12(32)-10	-	-	-	-	100	15 Class J/CC
ZB12-12	-	-	-	-	100	15 Class J/CC
ZB12-16	-	-	-	-	100	30 Class J/CC
ZB32-16	-	-	-	-	100	35 Class J
ZB32-24	-	-	-	-	100	45 Class J
ZB32-32	-	-	-	-	100	60 Class J
ZB65-10	100	15 Class J/CC	65	15	100	15 Class J/CC
ZB65-16	100	35 Class J/CC	65	25	100	35 Class J/CC
ZB65-24	100	45 Class J/CC	65	50	100	45 Class J/CC
ZB65-40	100	60 Class J/CC	65	60	100	60 Class J/CC
ZB65-57	100	110 Class J/CC	65	75	100	110 Class J/CC
ZB65-65	100	125 Class J/CC	65	100	100	125 Class J/CC
ZB65-75	100	125 Class J/CC	65	100	100	125 Class J/CC

			ZEB12, ZEB32	ZEB65-45	ZEB65-100	ZEB150	ZEB225
General							
Standards			IEC/EN 60947, VDE 0660, UL, CSA				
Climatic proofing			Damp heat, constant, to IEC 60068-2-78 Damp heat, cyclic, to IEC 60068-2-30				
Ambient temperature							
Open	°C		-25 - 65	-25 - 65	-25 - 65	-25 - 65	-25 - 65
Enclosed	°C		-25 - 65	-25 - 40	-25 - 40	-25 - 40	-25 - 40
Temperature compensation			Continuous	Continuous	Continuous	Continuous	Continuous
Mounting position			Any	Any	Any	Any	Any
Mechanical shock resistance half-sinusoidal shock 10 ms to IEC 60068-2-27	g		15	15	15	15	15
Protection rating			IP20	IP20	IP20	IP20	IP00
Busbar tag shroud when actuated from front (EN 50274)			Finger- and back-of-hand proof				
Main circuits							
Rated impulse withstand voltage	U_{imp}	V AC	6000	6000	6000	6000	6000
Overvoltage category/degree of pollution			III / 3	III / 3	III / 3	III / 3	III / 3
Rated insulation voltage	U_i	V AC	690	690	690	690	690
Rated operating voltage	U_e	V AC	690	690	690	690	690
Safe isolation according to EN 61140							
Between auxiliary contacts and main contacts		V AC	600	600	600	600	600
Between the main contacts		V AC	600	600	600	600	600
Overload relay setting range	A		0.3 - 45 → data sheet in online catalog	9 - 45	20 - 100	ZEB150-100: 20 - 100 ZEB150-175: 20 - 175	35 - 175
Terminal capacity							
Solid	mm ²		1 x (1.5 - 16)	1 x (4 - 16)	1 x (16 - 50)	ZEB150-100: 1 x (16 - 50) ZEB150-175: 1 x (10 - 95)	1 x (10 - 95)
Solid or stranded	AWG		1 x (14 - 4)	1 x (14 - 4)	1 x (6 - 1)	ZEB150-100: 1 x (6 - 1) ZEB150-175: 1 x (8 - 4/0)	1 x (8 - 4/0)
Auxiliary and actuating circuits							
Rated impulse withstand voltage	U_{imp}	V	6000	6000	6000	6000	6000
Overvoltage category/degree of pollution			III / 3	III / 3	III / 3	III / 3	III / 3
Terminal capacity							
Solid	mm ²		2 x (0.75 - 4)	2 x (0.75 - 4)	2 x (0.75 - 4)	2 x (0.75 - 4)	2 x (0.75 - 4)
Flexible with ferrule	mm ²		2 x (0.75 - 2.5)	2 x (0.75 - 2.5)	2 x (0.75 - 2.5)	2 x (0.75 - 2.5)	2 x (0.75 - 2.5)
Solid or stranded	AWG		2 x (18 - 12)	2 x (18 - 12)	2 x (18 - 12)	2 x (18 - 12)	2 x (18 - 12)
Terminal Screw			M3.5	M3.5	M3.5	M3.5	M3.5
Tightening torque	Nm		0.8 - 1.2	0.8 - 1.2	0.8 - 1.2	0.8 - 1.2	0.8 - 1.2
	lb-in		7	7	7	7	7
Tools							
Pozidriv screwdriver	Size		2	2	2	2	2
Standard screwdriver	mm		1 x 6	1 x 6	1 x 6	1 x 6	1 x 6
Auxiliary circuit rated insulation voltage	U_i	V AC	500	500	500	500	500
Rated operating voltage	U_e	V AC	500	500	500	500	500
Safe isolation according to EN 61140							
Between the auxiliary contacts		V AC	240	240	240	240	240
Conventional thermal current	I_{th}	A	5	5	5	5	5
Rated operational current							
AC-15							
N/O							
120 V	I_e	A	1.5	1.5	1.5	1.5	1.5
240 V	I_e	A	1.5	1.5	1.5	1.5	1.5
415 V	I_e	A	0.5	0.5	0.5	0.5	0.5
500 V	I_e	A	0.5	0.5	0.5	0.5	0.5
N/C							
120 V	I_e	A	1.5	1.5	1.5	1.5	1.5
240 V	I_e	A	1.5	1.5	1.5	1.5	1.5
415 V	I_e	A	0.9	0.9	0.9	0.9	0.9
500 V	I_e	A	0.8	0.8	0.8	0.8	0.8
DC-13 L/R ≤ 15 ms							
24 V	I_e	A	0.9	0.9	0.9	0.9	0.9
60 V	I_e	A	0.75	0.75	0.75	0.75	0.75
110 V	I_e	A	0.4	0.4	0.4	0.4	0.4
220 V	I_e	A	0.2	0.2	0.2	0.2	0.2
Short-circuit strength without welding							
max. Fuse	A gG/gL		6	6	6	6	6

ZEB12-1.65 ZEB12-5 ZEB12-20 ZEB32-20 ZEB65-45 ZEB65-100 ZEB150-100 ZEB150-175 ZEB225
ZEB32-1.65 ZEB32-5 ZEB32-45

Rating data for approved types

		ZEB12-1.65 ZEB32-1.65	ZEB12-5 ZEB32-5	ZEB12-20	ZEB32-20 ZEB32-45	ZEB65-45	ZEB65-100	ZEB150-100	ZEB150-175	ZEB225
Auxiliary contact										
Pilot duty										
	AC operated	B600	B600	B600	B600	B600	B600	B600	B600	B600
	DC operated	R300	R300	R300	R300	R300	R300	R300	R300	R300
Short Circuit Current Rating (SCCR)										
Basic Rating										
	SCCR	kA	1	-	-	-	-	-	-	-
	max. Fuse	A	6, RK5	-	-	-	-	-	-	-
600 V High Fault										
	SCCR (fuse)	kA	-	100	100	100	100	100	100	100
	max. Fuse	A	-	20 Class J	30 Class J	60 Class J	180 Class J	200 Class J	200 Class J	400 Class J

Dimensions

2

Motor protection relay

ZE...

Base

ZB32-XEZ, ZB65-XEZ

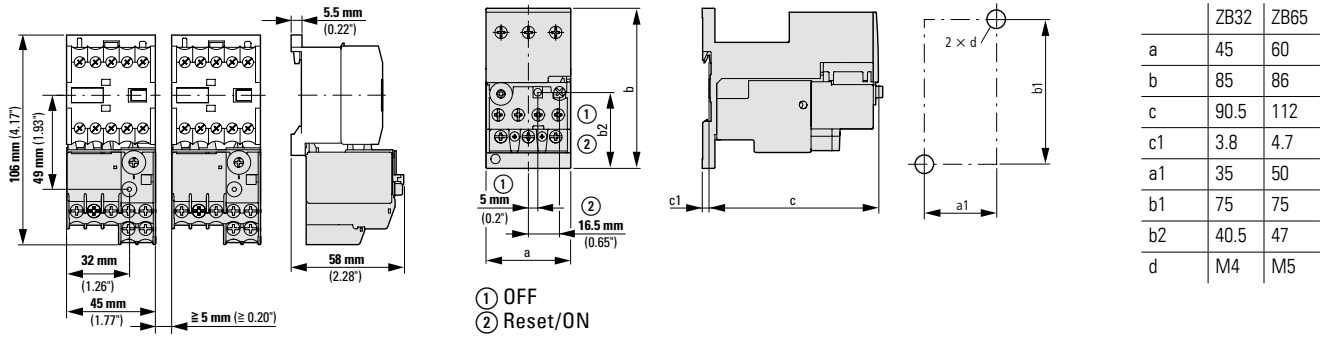

ZB12

ZB32

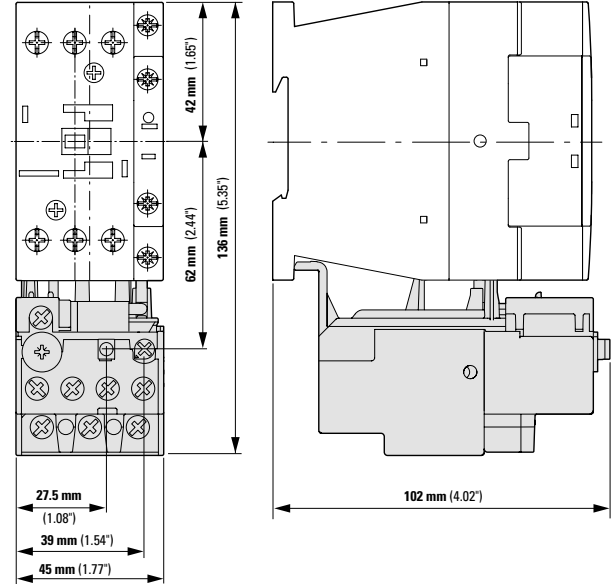
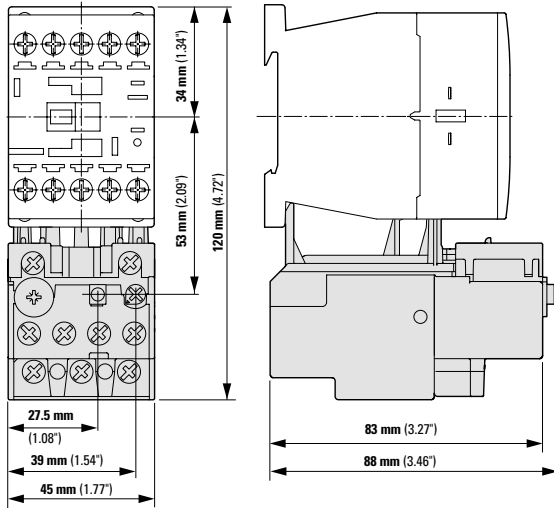

ZB32-38

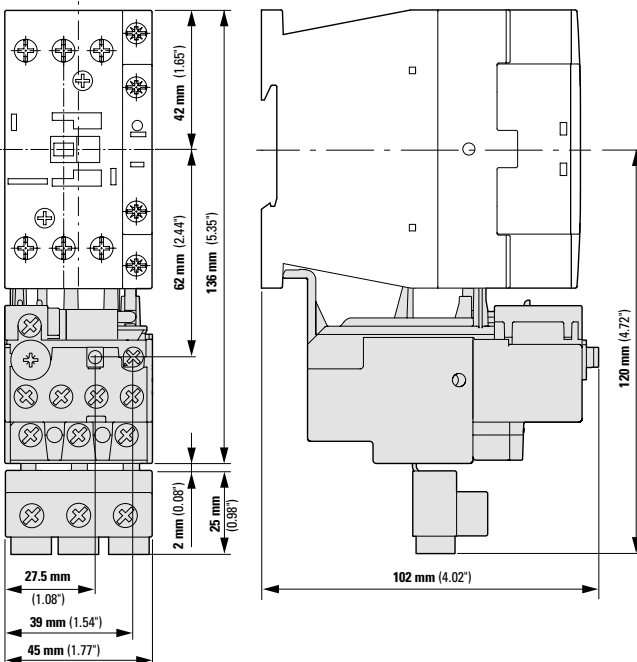

Motor protection relay

ZB65

2

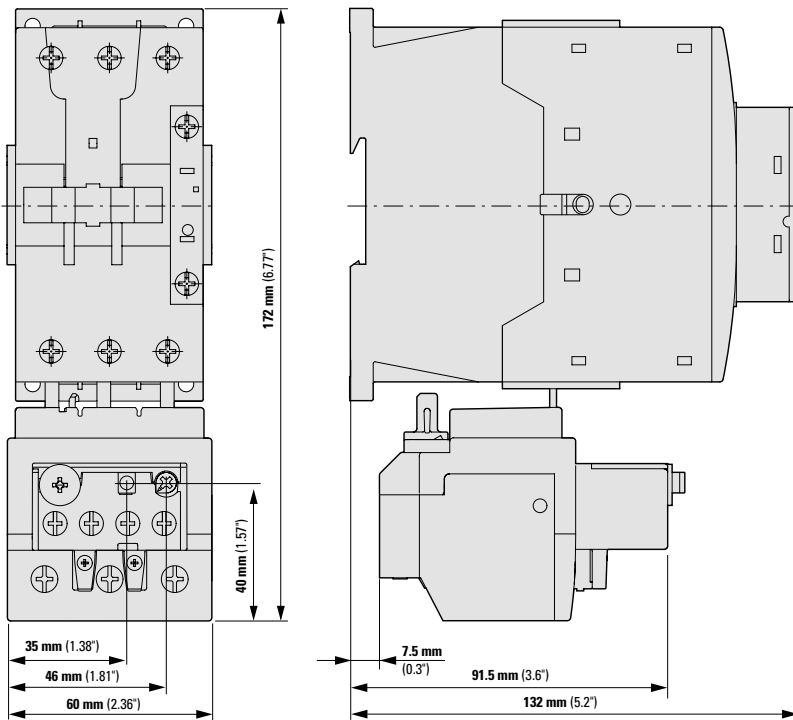

ZB150

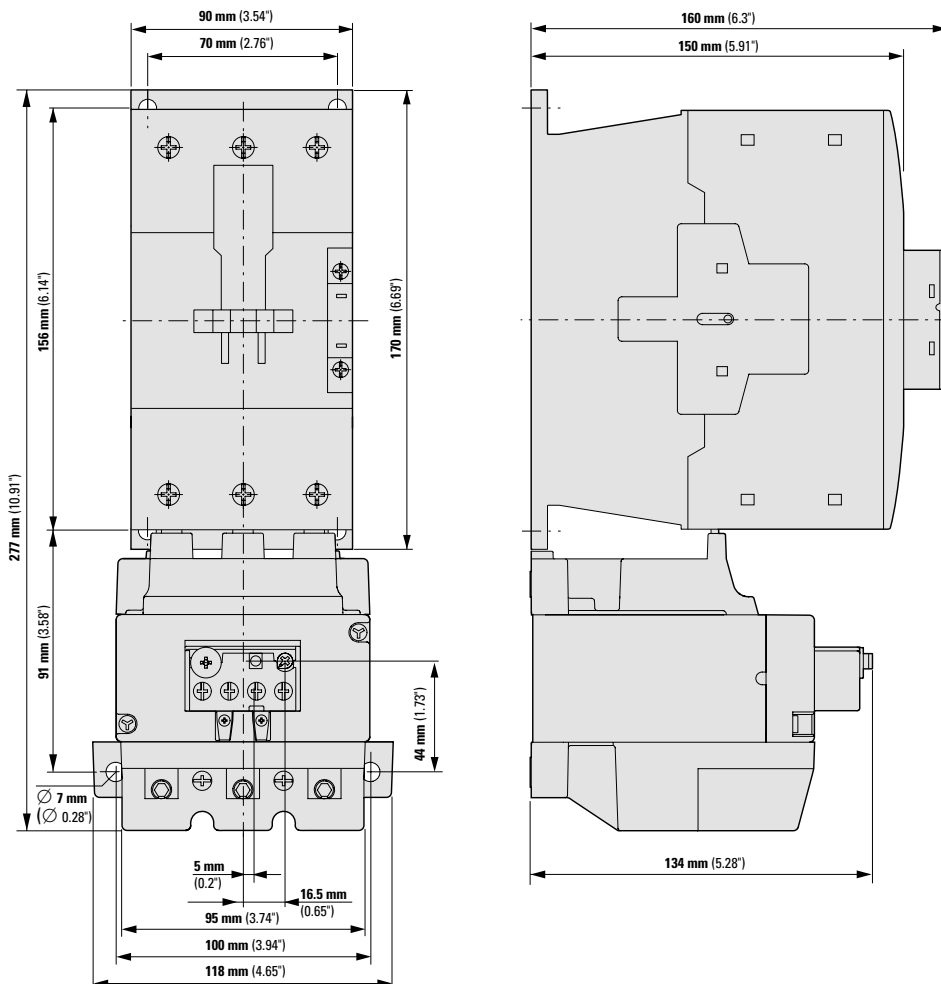

Motor protection relay

ZB150-50/KK

2

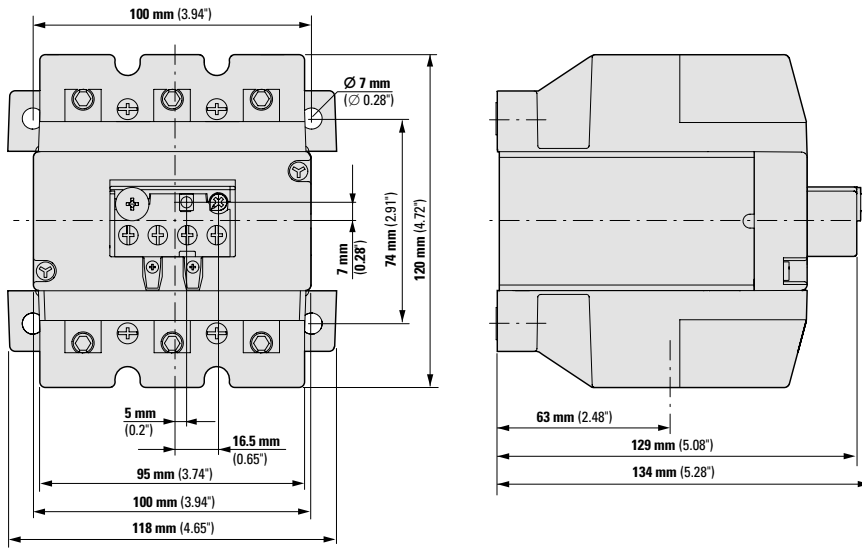

Z5 overload relays greater than 150A

Z5-.../FF225A

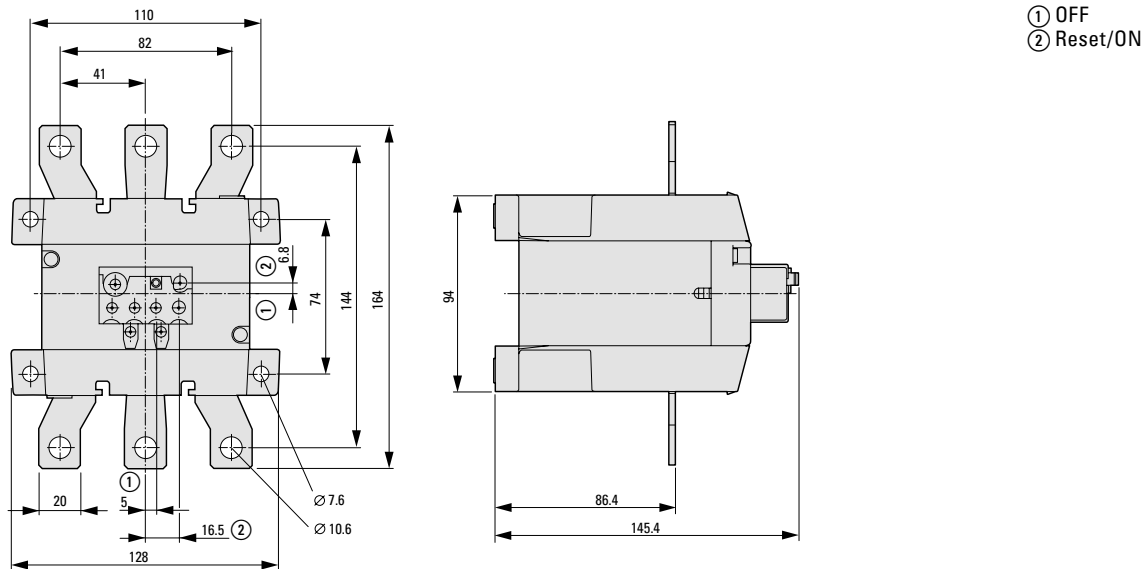

Z5-.../FF250

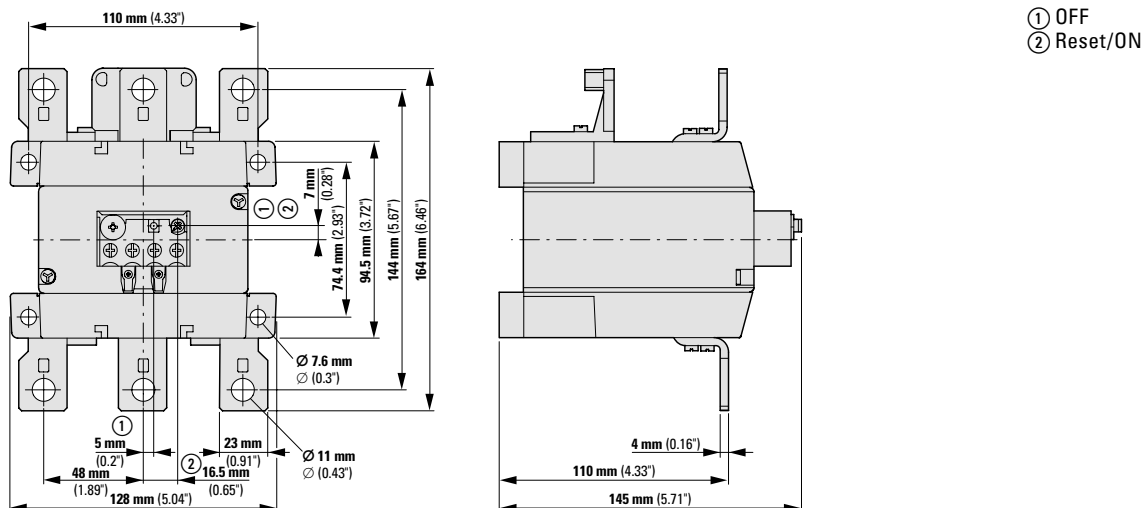

Transformer relay

ZW7...

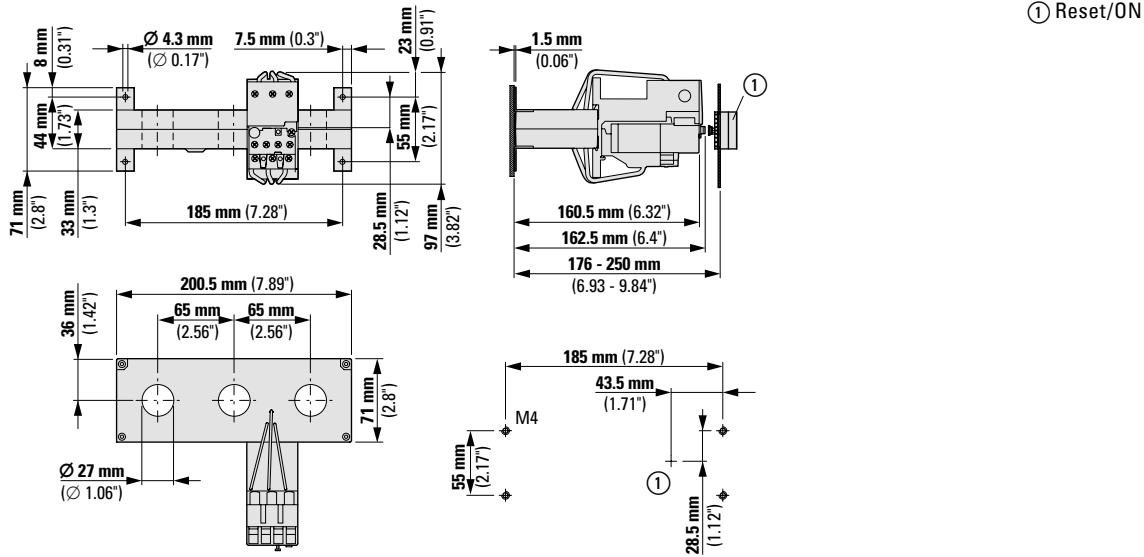

2

Electronic overload relays

ZEB12

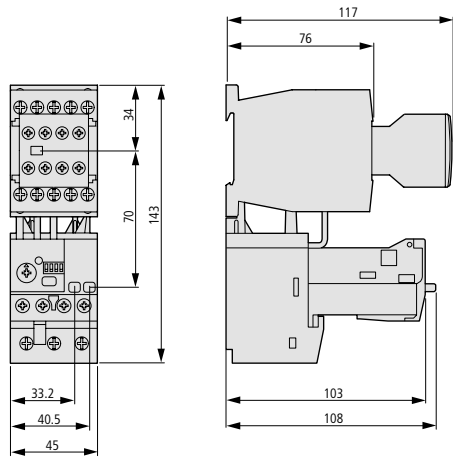

ZEB32

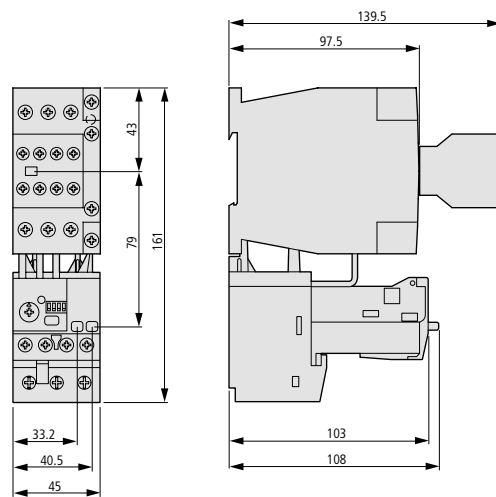

ZEB65-45

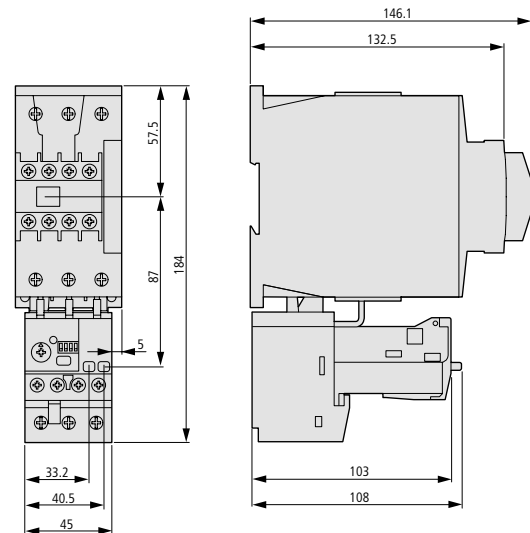

ZEB65-100

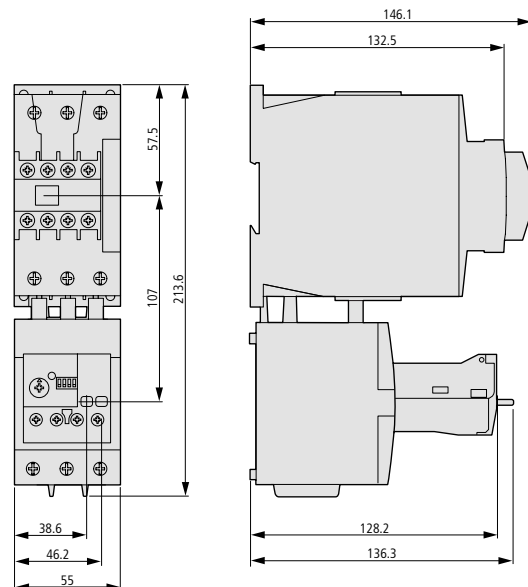

Electronic overload relays

ZEB150-100

2

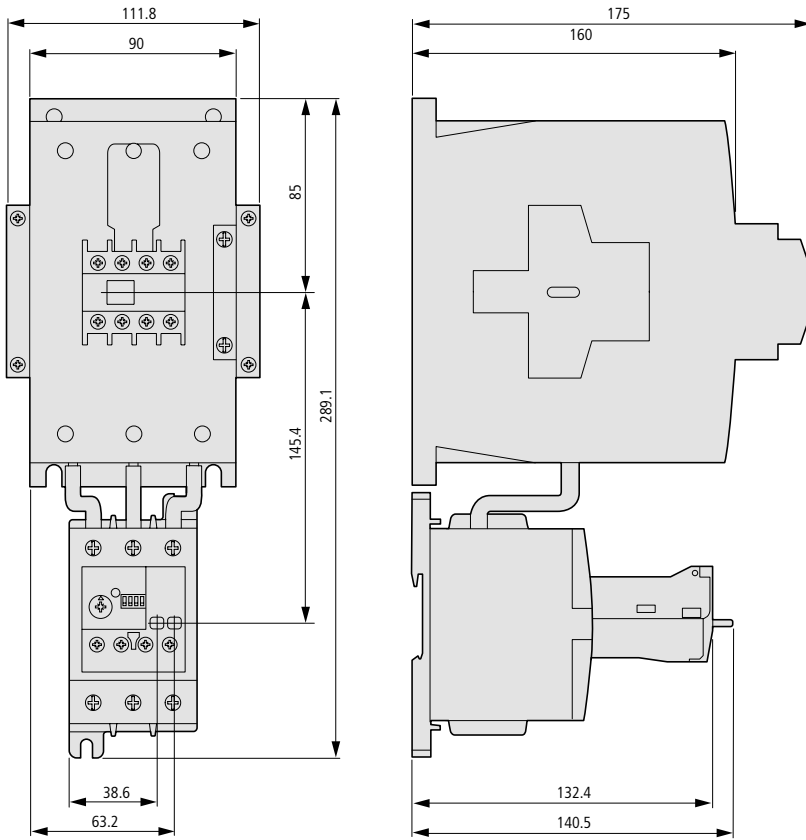

ZEB150-175

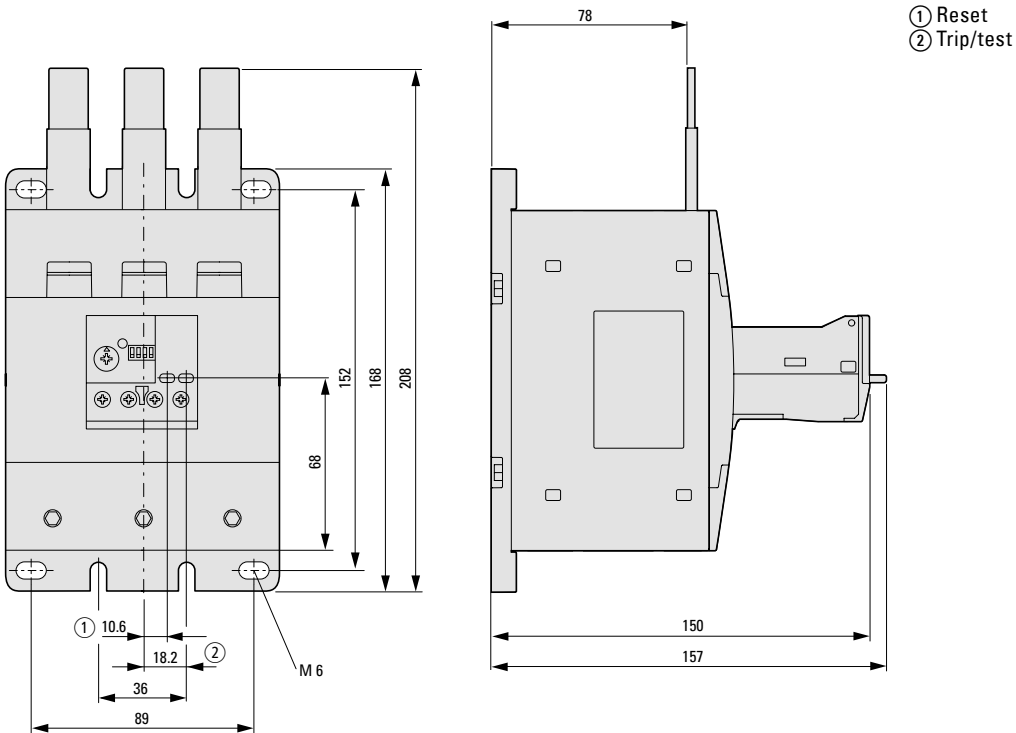

Electronic overload relays

ZEB225-175

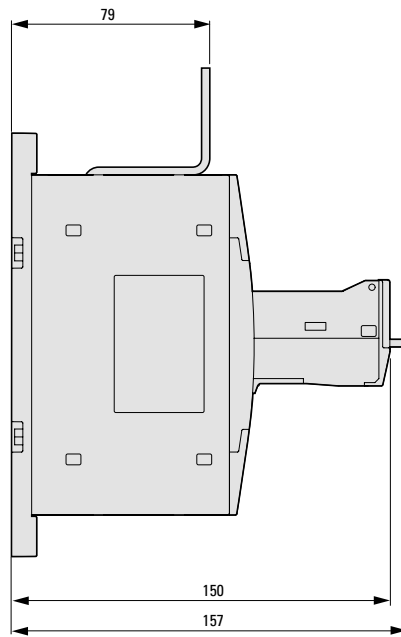
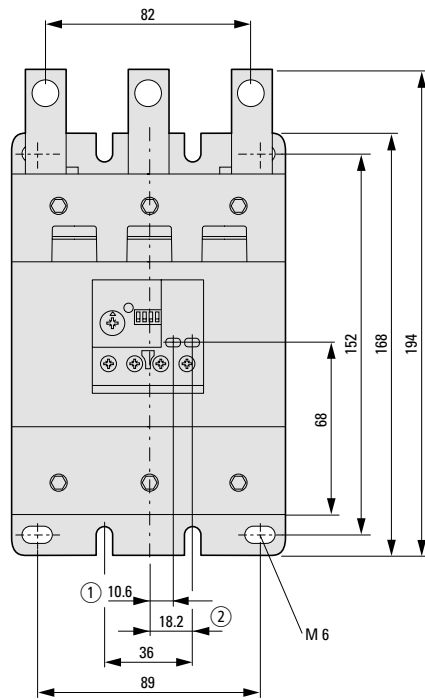

- ① Reset
- ② Trip/Test

Electronic overload relays

ZEB32-.../KK

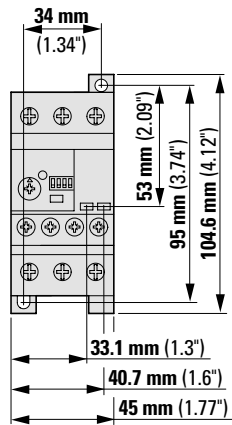

ZEB150-100(GF)/KK

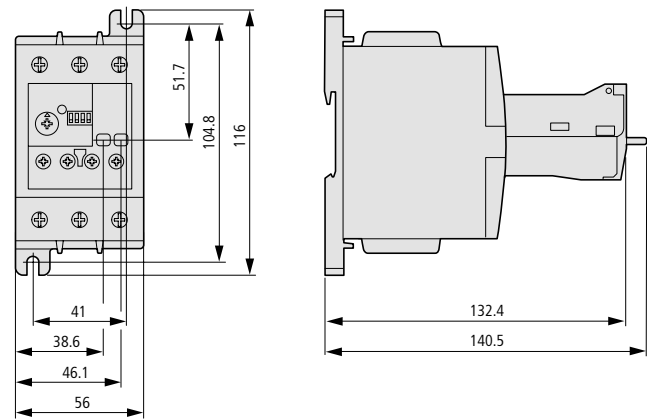

ZEB150-175(GF)/KK

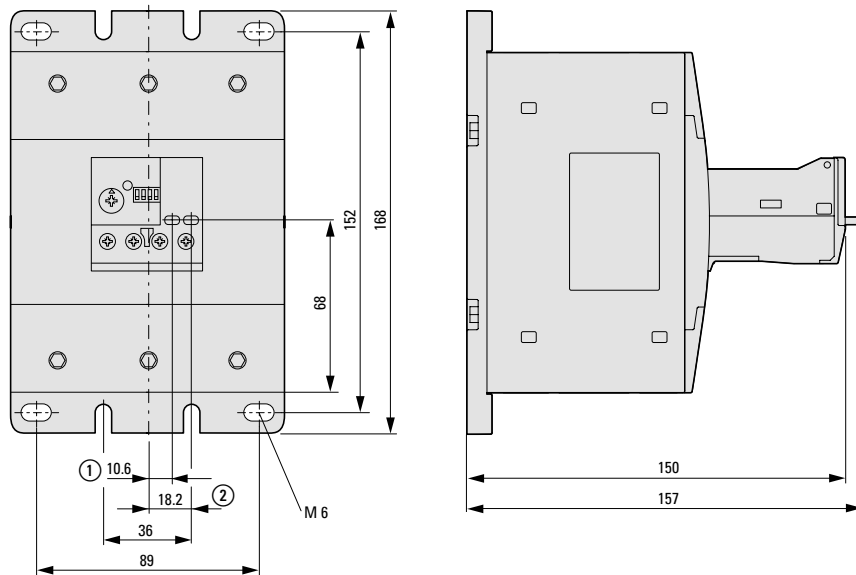

External reset button

M22-DZ-B
M22-DZ-X

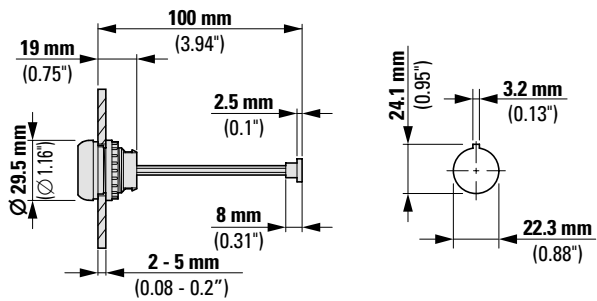

Build it in.



Motor-protective circuit breaker: Flexible solutions – simple, smart, plug-in and versatile

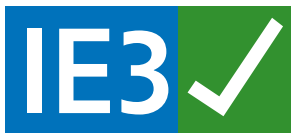

PKZ motor protection switch

PKZ motor-protective circuit breakers have been produced at Eaton since 1932. Since then, our ideas and developments have played a key role in the trend for protecting motors. The results are progressive concepts and marketable product innovations that time and again assume the role of international trendsetting, pioneering products, e.g. such as the motor-protective circuit breaker PKE.

Feeder system MSFS

The MSFS feeder system can be used as the basis for a safe and innovative power distribution system for currents of up to 125 A. Thanks to a plug-in mounting design, the modular solution can be easily and intuitively integrated into machines and systems. The feeder system can be used both remotely and also centrally in the power distribution, in the central power distribution or directly in the system.

Link module PKZM0-XDM32ME

The new link module represents an economical alternative to the existing link set PKZM0-XDM32, and is impressive with its more compact construction, its universal range of application and increased security.

PKZM0



3.0 Motor-protective circuit breakers	
3.1 System overview	3/2
System overview	3/2
3.2 Product selection	3/3
Motor-protective circuit breakers PKZM01 – push operation	3/3
Motor-protective circuit breakers PKZM01, PKZM4	3/4
Motor-protective circuit breakers PKZM0, PKZM4 – lockable rotary actuation	3/6
Motor-protective circuit breaker PKZM0 for starter combinations, transformer-protective circuit breakers	3/8
Motor-protective circuit breaker PKE, System circuit breaker PKE	3/10
Standard auxiliary contact NHI...-PKZ0	3/14
Trip indicating signal AGM, auxiliary contact VHI, voltage release A-PKZ0, U-PKZ0	3/16
3.3 Engineering	3/18
Accessories for motor-protective circuit breakers PKZM01, PKZM0 in enclosure	3/18
Accessories for motor-protective circuit breakers PKZM01, PKZM0, PKZM4 in enclosure	3/19
3.4 Product selection	3/20
Insulated enclosure for fitting CI-PKZ01..., CI-K2...-PKZ0...	3/20
Insulated enclosure for fitting CI-PKZ0..., CI-K...-PKZ...	3/21
Insulated enclosure for fitting E-PKZ01..., E-PKZ0...	3/22
Insulated enclosure for fitting CI-PKZ01-NA..., CI-K2-PKZ0-NA...	3/23
Current limiter CL-PKZ0, function element SWD, overload relay module PKE-XZMR...	3/24
Door coupling rotary handle PKZ0(E)-XH..., terminal cover HB-PKZ4	3/26
Accessories for insulated enclosure	3/27
Accessories for motor-protective circuit breaker	3/29
Busbar adapter MSF	3/30
Board, feed module MSF	3/31
Busbar adapter BBA	3/32
Busbar adapter BBA..., accessories for busbar adapter	3/34
Wiring set PKZM	3/35
Top-hat rail adapter plates PKZM...-XC	3/36
Three-phase commoning links B3...-PKZ0	3/37
Extension terminals BK.../3-PKZ	3/38
Three-phase commoning links B3...-PKZ4	3/39
Voltage release A-PKZ0, U-PKZ0, actuating voltages	3/40
3.5 Engineering	3/41
Characteristics	3/41
Switching capacity	3/44
3.6 Technical Data	3/48
PKZM..., PKE	3/48
Rating data for approved types	3/52
Accessories NHI...PKZ, AGM, U-PKZ, A-PKZ	3/54
3.7 Dimensions	3/55
PKZM01, PKZM0	3/55
Busbar adapter BBA	3/56
Top-hat rail adapter plates PKZM...-XC	3/57
Insulated enclosure	3/58
Insulated enclosure, motor-protective circuit breaker PKZM4-	3/60
Three-phase commoning links	3/61
Insulated enclosure PKZM4	3/62
Motor-protective circuit breaker, system circuit breaker PKE	3/63

System overview

3

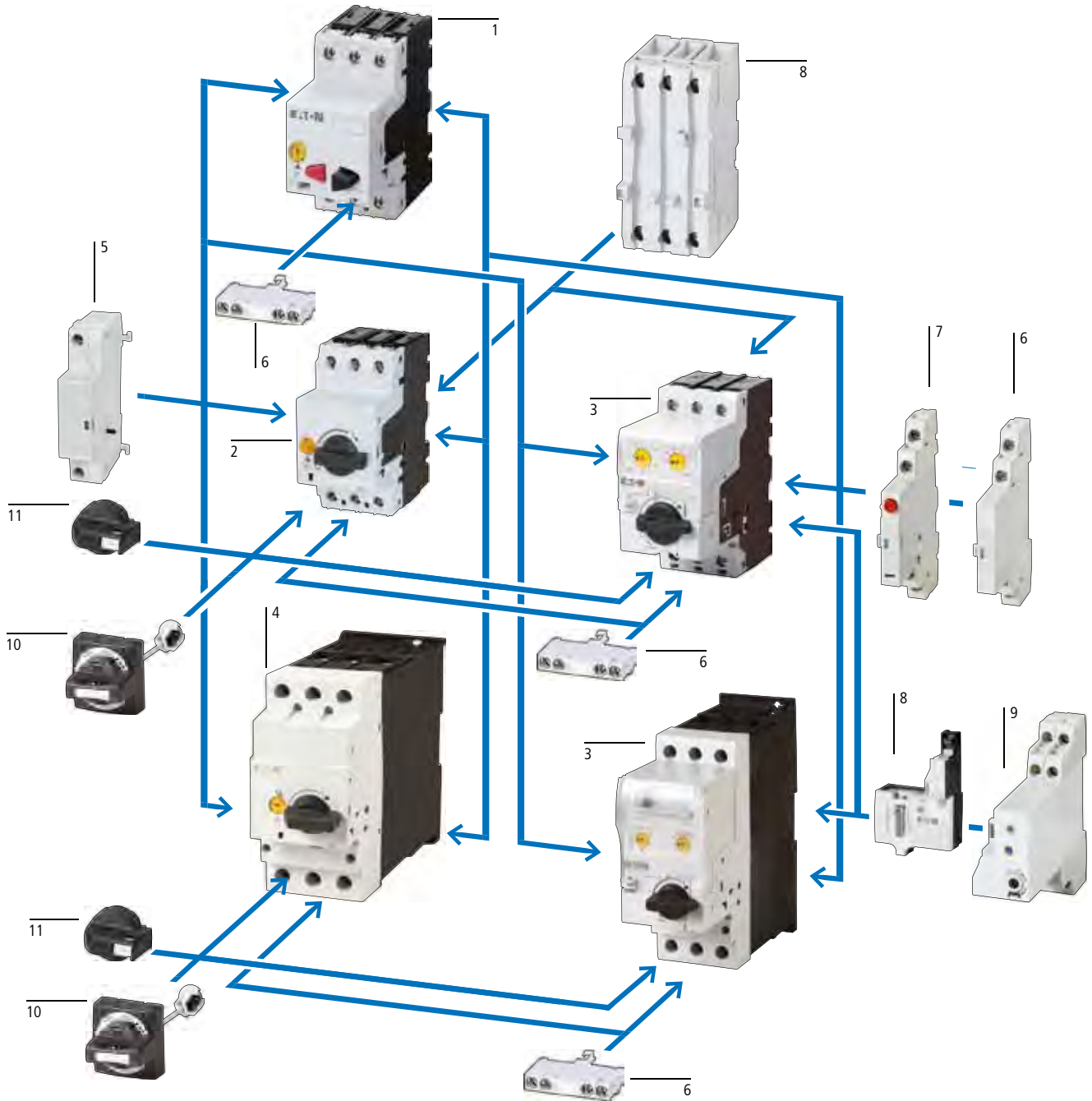

Basic devices

Motor-protective circuit breaker PKZM01	1
→ page 3/3	
Motor-protective circuit breaker PKZM0	2
→ page 3/4	
Motor-protective circuit breaker PKE with wide-range overload protection	3
→ page 3/10	
Motor-protective circuit breaker PKZM4	4
→ page 3/4	

Add-on functions



Voltage release	5
→ page 3/16	
Standard auxiliary contact	6
→ page 3/14	
Trip-indicating auxiliary contact	7
→ page 3/16	
SmartWire-DT module	8
→ page 3/24	
Overload relay module	9
→ page 3/24	

Assembly accessories

Door coupling handle IP65	10
→ page 3/26	
Lockable rotary handle	11
→ page 3/29	

Product selection

max. Motor rating AC-3			Rated uninterrupted current	Settings range		Type Article no.	Std. pack	Type Article no.	Std. pack
220 V	380 V	440 V		Overload trip	Short-circuit release				
230 V	400 V								
240 V	415 V								
P kW	P kW	P kW	I_u A	I_r A	I_{rm} A				

Motor-protective circuit breakers – type "1" and "2" coordination									
–	–	–	0.16	0.1 - 0.16	2.5	PKZM01-0.16¹⁾ 278475	1 pc.  	PKZM01-0.16-G 286068	1 pc.
–	0.06	0.06	0.25	0.16 - 0.25	3.9	PKZM01-0.25¹⁾ 278476		PKZM01-0.25-G 286069	
0.06	0.09	0.12	0.4	0.25 - 0.4	6.2	PKZM01-0.4¹⁾ 278477		PKZM01-0.4-G 286080	
0.09	0.12	0.18	0.63	0.4 - 0.63	9.8	PKZM01-0.63¹⁾ 278478		PKZM01-0.63-G 286081	
0.12	0.25	0.25	1	0.63 - 1	15.5	PKZM01-1¹⁾ 278479		PKZM01-1-G 286082	
0.25	0.55	0.55	1.6	1 - 1.6	24.8	PKZM01-1.6¹⁾ 278480		PKZM01-1.6-G 286083	
0.37	0.75	1.1	2.5	1.6 - 2.5	38.8	PKZM01-2.5¹⁾ 278481		PKZM01-2.5-G 286084	
0.75	1.5	1.5	4	2.5 - 4	62	PKZM01-4¹⁾ 278482		PKZM01-4-G 286085	
1.1	2.2	3	6.3	4 - 6.3	97.7	PKZM01-6.3¹⁾ 278483		PKZM01-6.3-G 286086	
2.2	4	4	10	6.3 - 10	155	PKZM01-10¹⁾ 278484		PKZM01-10-G 286087	
3	5.5	5.5	12	8 - 12	186	PKZM01-12¹⁾ 278485		PKZM01-12-G 286088	
4	7.5	9	16	10 - 16	248	PKZM01-16¹⁾ 283390		PKZM01-16-G 286089	
5.5	9	11	20	16 - 20	310	PKZM01-20¹⁾ 283383		–	
5.5	12.5	12.5	25	20 - 25	388	PKZM01-25¹⁾ 288893		–	

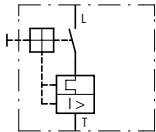
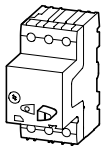

Notes

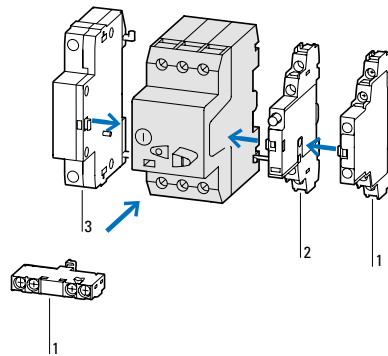

Accessories

- 1 Standard auxiliary contact → 3/14
 - 2 Trip-indicating auxiliary contact → 3/16
 - 3 Shunt release, undervoltage release → 3/16
- Phase failure sensitivity to IEC/EN 60947-4-1, VDE 0660 part 102.
 Overload trigger: tripping class 10 A
 Snap-on to IEC/EN 60715 top-hat rail with 7.5 or 15 mm height.

Information relevant for export to North America



1)	
Product standards	IEC/EN 60947-4-1; UL 60947-4-1; CSA-C22.2 No. 60947-4-1-14; CE marking
UL File No.	E36332
UL CCN	NLRV
CSA File No.	165628
CSA Class No.	3211-05
NA Certification	UL Listed, CSA certified



Also suitable for motors with efficiency class IE3.
 IE3-ready devices are identified by the logo on their packaging.

Motor-protective circuit breaker PKZM0, PKZM4

3

Screw terminals

Screw terminals feed side, spring-loaded terminals secondary side

Spring-loaded terminals

max. Motor rating AC-3					Rated uninter-rupted current	Settings range		Type Article no.	Type Article no.	Type Article no.
220 V	380 V	440 V	500 V	660 V		Overload trip	Short-circuit releases			
230 V	400 V			690 V	I_n	I_r	I_m			
240 V	415 V									
P kW	P kW	P kW	P kW	P kW	I_n A	I_r A	I_m A			

Motor-protective circuit breaker PKZM0 – type “1” and “2” coordination¹⁾

IE3 ✓											
–	–	–	–	0.06	0.16	0.1 - 0.16	2.5	PKZM0-0.16 072730	PKZM0-0.16-SC 229828	PKZM0-0.16-C 229669	
–	0.06	0.06	0.06	0.12	0.25	0.16 - 0.25	3.9	PKZM0-0.25 072731	PKZM0-0.25-SC 229829	PKZM0-0.25-C 229670	
0.06	0.09	0.12	0.12	0.18	0.4	0.25 - 0.4	6.2	PKZM0-0.4 072732	PKZM0-0.4-SC 229830	PKZM0-0.4-C 229671	
0.09	0.12	0.18	0.25	0.25	0.63	0.4 - 0.63	9.8	PKZM0-0.63 072733	PKZM0-0.63-SC 229831	PKZM0-0.63-C 229672	
0.12	0.25	0.25	0.37	0.55	1	0.63 - 1	15.5	PKZM0-1 072734	PKZM0-1-SC 229832	PKZM0-1-C 229673	
0.25	0.55	0.55	0.75	1.1	1.6	1 - 1.6	24.8	PKZM0-1.6 072735	PKZM0-1.6-SC 229833	PKZM0-1.6-C 229674	
0.37	0.75	1.1	1.1	1.5	2.5	1.6 - 2.5	38.8	PKZM0-2.5 072736	PKZM0-2.5-SC 229834	PKZM0-2.5-C 229675	
0.75	1.5	1.5	2.2	3	4	2.5 - 4	62	PKZM0-4 072737	PKZM0-4-SC 229835	PKZM0-4-C 229676	
1.1	2.2	3	3	4	6.3	4 - 6.3	97.7	PKZM0-6.3 072738	PKZM0-6.3-SC 229836	PKZM0-6.3-C 229677	
2.2	4	4	4	7.5	10	6.3 - 10	155	PKZM0-10 072739	PKZM0-10-SC 229837	PKZM0-10-C 229678	
3	5.5	5.5	5.5	11	12	8 - 12	186	PKZM0-12 278486	PKZM0-12-SC 278487	PKZM0-12-C 278488	
4	7.5	9	9	12.5	16	10 - 16	248	PKZM0-16 046938	PKZM0-16-SC 229838	PKZM0-16-C 229679	
5.5	9	11	12.5	15	20	16 - 20	310	PKZM0-20 046988			
5.5	12.5	12.5	15	22	25	20 - 25	388	PKZM0-25 046989			
7.5	15	15	22	30	32	25 - 32	496	PKZM0-32 278489			

Motor-protective circuit breaker PKZM4 – type “1” and “2” coordination¹⁾

IE3 ✓											
4	7.5	9	9	12.5	16	10 - 16	248	PKZM4-16 222350			
5.5	12.5	12.5	15	22	25	16 - 25	388	PKZM4-25 222352			
7.5	15	17.5	22	22	32	24 - 32	496	PKZM4-32 222353			
11	20	22	24	30	40	32 - 40	620	PKZM4-40 222354			
14	25	30	30	45	50	40 - 50	775	PKZM4-50 222355			
17	30	37	37	55	58	50 - 58	899	PKZM4-58 222394			
18.5	34	37	45	55	65	55 - 65	1008	PKZM4-63 222413			

Circuit breaker²⁾

For protection of cables and conductors

–	–	–	–	–	16	10 - 16	248	PKZM4-16-CB 132591		
–	–	–	–	–	25	16 - 25	388	PKZM4-25-CB 132592		
–	–	–	–	–	32	24 - 32	496	PKZM4-32-CB 132593		

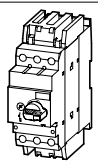
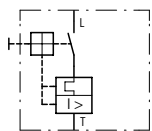
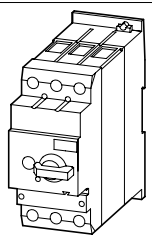
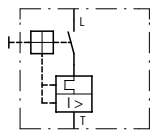
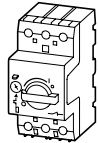

Std. pack **Notes**

Information relevant for export to North America



1 pc.

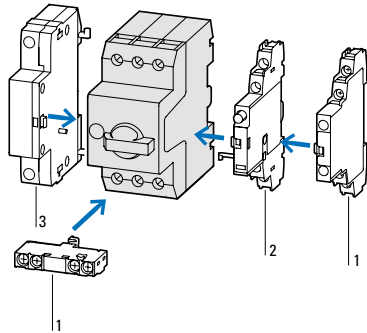

Accessories

- 1 Standard auxiliary contact → 3/14
 - 2 Trip-indicating auxiliary contact → 3/16
 - 3 Shunt release, undervoltage release → 3/40
- Phase failure sensitivity to IEC/EN 60947-4-1, VDE 0660 part 102.
 Overload trigger: tripping class 10 A
 Snap-on to IEC/EN 60715 top-hat rail with 7.5 or 15 mm height.
- Observe the PTB 10, ATEX 3013 → 3/29
 Ex II(2) GD
 manual MN03402003Z-DE/EN.

Page

1)

Product standards IEC/EN 60947-4-1; UL 60947-4-1; CSA-C22.2 No. 60947-4-1-14; CE marking
UL File No. E36332
UL CCN NLRV
CSA File No. 165628
CSA Class No. 3211-05
NA Certification UL Listed, CSA certified
Suitable for Branch circuit: Manual type E if used with terminal, or suitable for group installations
See also → page 3/53



Also suitable for motors with efficiency class IE3. IE3-ready devices are identified by the logo on their packaging.

1 pc.

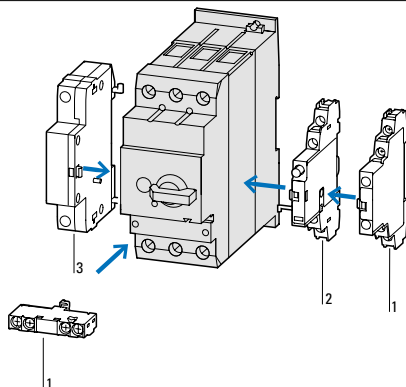

Accessories

- 1 Standard auxiliary contact → 3/14
 - 2 Trip-indicating auxiliary contact → 3/16
 - 3 shunt releases, undervoltage releases → 3/40
- Phase failure sensitivity to IEC/EN 60947-4-1, VDE 0660 part 102.
 Overload trigger: tripping class 10 A
 Snap-on to IEC/EN 60715 top-hat rail with 7.5 or 15 mm height.
- Observe the PTB 10, ATEX 3012 → 3/29
 Ex II(2) G
 manual MN03402002Z-DE/EN.

Page

1 pc.

Not usable as a main switch
 Phase failure sensitivity to IEC/EN 60947-4-1, VDE 0660 part 102
 Switching capacity SCCR
 65 kA (480 Y/277 V)
 22 kA (600 Y/347 V)

2)

Product standards UL 489; CSA-C22.2 no. 5-09; IEC60947-4-1; CE marking
UL File No. E31593
UL CCN DIVQ
CSA File No. 165628
CSA Class No. 1432-01
NA Certification UL Listed, CSA certified
Specially designed for NA Yes
Suitable for Feeder and branch circuit as BCPD

Motor-protective circuit breakers PKZM0, PKZM4 – rotary operation, lockable

3

Screw terminals

max. Motor rating AC-3					Rated uninterrupted current	Settings range		Type Article no.
220 V	380 V	440 V	500 V	660 V		Overload trip	Short-circuit releases	
230 V	400 V			690 V	I_n	I_{rm}		
240 V	415 V				A	A		
P	P	P	P	P	I_u			
kW	kW	kW	kW	kW	A			

Motor-protective circuit breaker – type “1” and “2” coordination¹⁾

IE3 ✓	–	–	–	–	0.06	0.16	0.1 - 0.16	2.5	PKZM0-0.16/AK 265330
	–	0.06	0.06	0.06	0.12	0.25	0.16 - 0.25	3.9	PKZM0-0.25/AK 265332
	0.06	0.09	0.12	0.12	0.18	0.4	0.25 - 0.4	6.2	PKZM0-0.4/AK 265333
	0.09	0.12	0.18	0.25	0.25	0.63	0.4 - 0.63	9.8	PKZM0-0.63/AK 265334
	0.12	0.25	0.25	0.37	0.55	1	0.63 - 1	15.5	PKZM0-1/AK 265335
	0.25	0.55	0.55	0.75	1.1	1.6	1 - 1.6	24.8	PKZM0-1.6/AK 265336
	0.37	0.75	1.1	1.1	1.5	2.5	1.6 - 2.5	38.8	PKZM0-2.5/AK 265337
	0.75	1.5	1.5	2.2	3	4	2.5 - 4	62	PKZM0-4/AK 265338
	1.1	2.2	3	3	4	6.3	4 - 6.3	97.7	PKZM0-6.3/AK 265339
	2.2	4	4	4	7.5	10	6.3 - 10	155	PKZM0-10/AK 265340
	3	5.5	5.5	5.5	11	12	8 - 12	186	PKZM0-12/AK 156397
	4	7.5	9	9	12.5	16	10 - 16	248	PKZM0-16/AK 265342
	5.5	9	11	12.5	15	20	16 - 20	310	PKZM0-20/AK 265343
	5.5	12.5	12.5	15	22	25	20 - 25	388	PKZM0-25/AK 265344
	7.5	15	15	22	30	32	25 - 32	496	PKZM0-32/AK 156398

Motor-protective circuit breaker – type “1” and “2” coordination¹⁾

IE3 ✓	4	7.5	9	9	12.5	16	10 - 16	248	PKZM4-16/AK 158250
	5.5	12.5	12.5	15	22	25	16 - 25	388	PKZM4-25/AK 158251
	7.5	15	17.5	22	22	32	24 - 32	496	PKZM4-32/AK 158252
	11	20	22	24	30	40	32 - 40	620	PKZM4-40/AK 158253
	14	25	30	30	45	50	40 - 50	775	PKZM4-50/AK 158254
	17	30	37	37	55	58	50 - 58	899	PKZM4-58/AK 158255
	18.5	34	37	45	55	65	55 - 65	1008	PKZM4-63/AK 158256

Circuit breaker²⁾

For protection of cables and conductors

–	–	–	–	–	16	10 - 16	248	PKZM4-16-CB/AK 150622
–	–	–	–	–	25	16 - 25	388	PKZM4-25-CB/AK 150623
–	–	–	–	–	32	24 - 32	496	PKZM4-32-CB/AK 150624

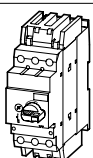
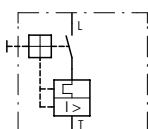
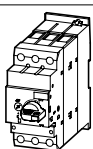
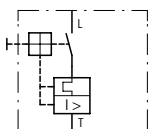
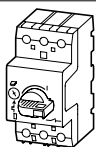

Std. pack **Notes**

Information relevant for export to North America



1 pc.

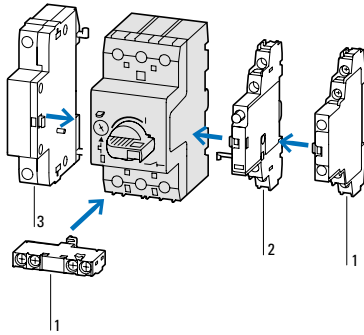

Accessories

- 1 Standard auxiliary contact → 3/14
 - 2 Trip-indicating auxiliary contact → 3/16
 - 3 Shunt release, undervoltage release → 3/40
- Phase failure sensitivity to IEC/EN 60947-4-1, VDE 0660 part 102.
 Overload trigger: tripping class 10 A
 Snap-on to IEC/EN 60715 top-hat rail with 7.5 or 15 mm height.
- Observe the PTB 10, ATEX 3013 → 3/29
 Ex II(2) GD
- manual MN03402003Z-DE/EN.

Page

1)

Product standards IEC/EN 60947-4-1; UL 60947-4-1; CSA-C22.2 No. 60947-4-1-14; CE marking
 UL File No. E36332
 UL CCN NLRV
 CSA File No. 165628
 CSA Class No. 3211-05
 NA Certification UL Listed, CSA certified
 Suitable for Branch circuit: Manual type E if used with terminal, or suitable for group installations
 See also → page 3/53



Also suitable for motors with efficiency class IE3. IE3-ready devices are identified by the logo on their packaging.

1 pc.

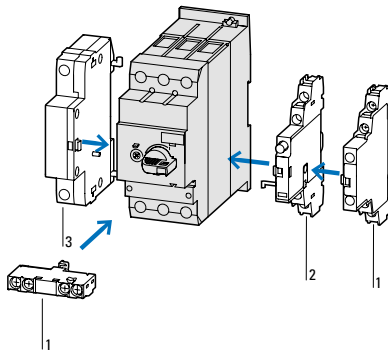

Accessories

- 1 Standard auxiliary contact → 3/14
 - 2 Trip-indicating auxiliary contact → 3/16
 - 3 shunt releases, undervoltage releases → 3/40
- Phase failure sensitivity to IEC/EN 60947-4-1, VDE 0660 part 102.
 Overload trigger: tripping class 10 A
 Snap-on to IEC/EN 60715 top-hat rail with 7.5 or 15 mm height.
- Observe the PTB 10, ATEX 3012 → 3/29
 Ex II(2) G
- manual MN03402002Z-DE/EN.

Page

1 pc.



Not usable as a main switch
 Phase failure sensitivity to IEC/EN 60947-4-1, VDE 0660 part 102
 Switching capacity SCCR
 65 kA (480 Y/277 V)
 22 kA (600 Y/347 V)

2)

Product standards UL 489; CSA-C22.2 no. 5-09; IEC60947-4-1; CE marking
 UL File No. E31593
 UL CCN DIVQ
 CSA File No. 165628
 CSA Class No. 1432-01
 NA Certification UL Listed, CSA certified
 Specially designed for NA Yes
 Suitable for Feeder and branch circuit as BCPD

Motor-protective circuit breakers PKZMO for starter combinations, transformer-protective circuit breaker

3

max. Motor rating					Rated uninterrupted current	Settings range		Type Article no.	Screw terminals	Std. pack
AC-3						Overload trip	Short-circuit releases			
220 V	380 V	440 V	500 V	660 V	I_u A		I_{rm} A 			
230 V	400 V		690 V							
240 V	415 V									
P	P	P	P	P						
kW	kW	kW	kW	kW						

Motor-protective circuit breaker for starter combinations

Short-circuit protective breaker without overload function

-	-	-	-	0.06	0.16	-	2.5	PKM0-0.16 072720	1 pc.
-	0.06	0.06	0.06	0.12	0.25	-	3.9	PKM0-0.25 072721	
0.06	0.09	0.12	0.12	0.18	0.4	-	6.2	PKM0-0.4 072722	
0.09	0.12	0.18	0.25	0.25	0.63	-	9.8	PKM0-0.63 072723	
0.12	0.25	0.25	0.38	0.55	1	-	15.5	PKM0-1 072724	
0.25	0.37	0.55	0.75	1.1	1.6	-	24.8	PKM0-1.6 072725	
0.37	0.75	1.1	1.1	1.5	2.5	-	38.8	PKM0-2.5 072726	
0.75	1.5	1.5	2.2	3	4	-	62	PKM0-4 072727	
1.1	2.2	3	3	4	6.3	-	97.7	PKM0-6.3 072728	
2.2	4	4	4	7.5	10	-	155	PKM0-10 072729	
3	5.5	5.5	5.5	11	12	-	186	PKM0-12 278490	
4	7.5	9	9	12.5	16	-	248	PKM0-16 044502	
5.5	9	11	12.5	15	20	-	310	PKM0-20 203594	
5.5	12.5	12.5	15	22	25	-	388	PKM0-25 044503	
7.5	15	15	22	30	32	-	496	PKM0-32 278491	

transformer-protective circuit breaker

-	-	-	-	-	0.16	0.1 - 0.16	2.4	PKZM0-0.16-T 088907	1 pc.
-	-	-	-	-	0.25	0.16 - 0.25	4.25	PKZM0-0.25-T 088908	
-	-	-	-	-	0.4	0.25 - 0.4	6.8	PKZM0-0.4-T 088909	
-	-	-	-	-	0.63	0.4 - 0.63	12	PKZM0-0.63-T 088910	
-	-	-	-	-	1	0.63 - 1	20	PKZM0-1-T 088911	
-	-	-	-	-	1.6	1 - 1.6	32	PKZM0-1.6-T 088912	
-	-	-	-	-	2.5	1.6 - 2.5	50	PKZM0-2.5-T 088913	
-	-	-	-	-	4	2.5 - 4	84	PKZM0-4-T 088914	
-	-	-	-	-	6.3	4 - 6.3	141	PKZM0-6.3-T 088915	
-	-	-	-	-	10	6.3 - 10	224	PKZM0-10-T 088916	
-	-	-	-	-	12	8 - 12	224	PKZM0-12-T 278492	
-	-	-	-	-	16	10 - 16	280	PKZM0-16-T 088917	
-	-	-	-	-	20	16 - 20	350	PKZM0-20-T 088918	
-	-	-	-	-	25	20 - 25	437	PKZM0-25-T 278493	

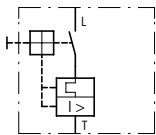
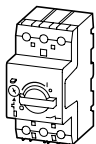
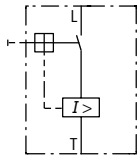
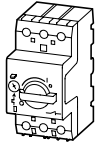

Notes

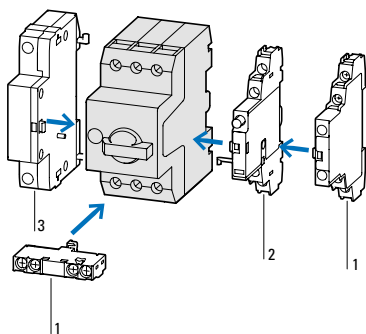

When using the PKM0 as short-circuit protection for motors with heavy starting duty, the rated operational current I_n when designing the switchgear must be over-dimensioned with the following factors:

- CLASS 5: 1.0
- CLASS 10: 1.0
- CLASS 15: 1.22
- CLASS 20: 1.41
- CLASS 25: 1.58
- CLASS 30: 1.73
- CLASS 35: 1.89
- CLASS 40: 2.0

Accessories

- 1 Standard auxiliary contact → 3/14
- 2 Trip-indicating auxiliary contact → 3/16
- 3 Shunt release, undervoltage release → 3/40
- Snap-on to IEC/EN 60715 top-hat rail with 7.5 or 15 mm height
- Allocation of short-circuit protective beaker and contactor in chapter 4 → 4/2

Page

An appropriate overload relay must be fitted to protect motors against overload.

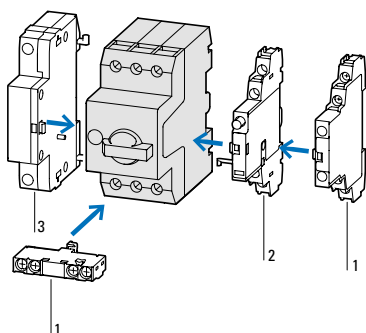

Accessories

- 1 Standard auxiliary contact → 3/14
- 2 Trip-indicating auxiliary contact → 3/16
- 3 Shunt release, undervoltage release → 3/40

Page

For the protection of transformers with a high inrush current
 Snap-on to IEC/EN 60715 top-hat rail with 7.5 or 15 mm height
 Phase failure sensitivity to IEC/EN 60947-4-1, VDE 0660 part 102.

Motor-protective circuit breaker PKE, system circuit breaker PKE

3

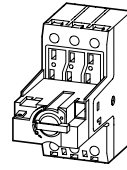

Motor Power P kW	Rated motor current AC-3					Overload release setting range I_r A	Basic device with standard knob Basic device with AK lockable rotary handle Type Article no.	Std. pack	Trip block motor protection Standard Type Article no.
	220 V	380 V	440 V	500 V	660 V				
	230 V	400 V			690 V				
	240 V	415 V							

Motor-protective circuit breaker PKE, type "1" and "2" coordination

Motor Power (kW)	220 V (A)	380 V (A)	440 V (A)	500 V (A)	660 V (A)	Overload release setting range (I_r)	Basic device with standard knob / Basic device with AK lockable rotary handle (Type / Article no.)	Std. pack	Trip block system protection Standard (Type / Article no.)
0.06	0.37	-	-	-	-	0.3 - 1.2	PKE12 ²⁾ 121721	1 pc.	PKE-XTU-1,2 ¹⁾ 121723
0.09	0.54	0.31	-	-	-		PKE12/AK ²⁾ 158241		
0.12	0.72	0.41	0.37	0.33	-				
0.18	1.04	0.6	0.54	0.48	0.35				
0.25	-	0.8	0.76	0.7	0.5				
0.37	-	1.1	1.02	0.9	0.7				
0.55	-	-	-	-	0.9				
0.75	-	-	-	-	1.1				
0.18	1.04	-	-	-	-	1 - 4	PKE12 ²⁾ 121721		PKE-XTU-4 ¹⁾ 121724
0.25	1.4	-	-	-	-		PKE12/AK ²⁾ 158241		
0.37	2	1.1	1.02	-	-				
0.55	2.7	1.5	1.39	1.2	-				
0.75	3.2	1.9	1.68	1.5	1.1				
1.1	-	2.6	2.41	2.1	1.5				
1.5	-	3.6	3.28	2.9	2.1				
2.2	-	-	-	4	2.9				
3	-	-	-	-	3.8				
0.75	3.2	-	-	-	-	3 - 12	PKE12 ²⁾ 121721		PKE-XTU-12 ¹⁾ 121725
1.1	4.6	-	-	-	-		PKE12/AK ²⁾ 158241		
1.5	6.3	3.6	3.3	-	-				
2.2	8.7	5	4.6	4	-				
3	11.5	6.6	6	5.3	3.8				
4	-	8.5	7.7	6.8	4.9				
5.5	-	11.3	10.2	9	6.5				
7.5	-	-	-	-	8.8				
2.2	8.7	-	-	-	-	8 - 32	PKE32 ²⁾ 121722		PKE-XTU-32 ¹⁾ 121726
3	11.5	-	-	-	-		PKE32/AK ²⁾ 158245		
4	14.8	8.5	-	-	-				
5.5	19.6	11.3	10.2	9	-				
7.5	26.4	15.2	13.8	12.1	8.8				
11	-	21.7	19.8	17.4	12.6				
15	-	29.3	26.6	23.4	17				
18.5	-	-	-	28.9	20.9				
22	-	-	-	-	23.8				
30	-	-	-	-	32				

Rated uninterrupted current I_u A	Settings range		short-circuit release I_{rm} A	Basic device with standard knob Type Article no.	Std. pack	Trip block system protection Standard Type Article no.
	Overload trigger I_r					
	I_r					

System protective circuit breakers PKE

36	15 - 36	75 - 288	PKE32 ²⁾ 121722	1 pc.	PKE-XTUCP-36 153164
----	---------	----------	--------------------------------------	-------	-------------------------------

Information relevant for export to North America

→ page 3/12

Motor-protective circuit breaker PKE, system circuit breaker PKE

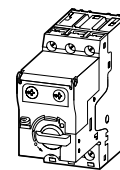

For use with

Trip block motor protection
Extended

For use with
Connection to SmartWire-DT
With
PKE-SWD-32 or
PKE-SWD-SP
→ page 3/24

Complete device with stan-
dard handle
Complete device with AK
lockable rotary handle

Std. pack

Type
Article no.

Std. pack

Type
Article no.

Std. pack

Basic device PKE12

1 pc.
 

PKE-XTUA-1.2¹⁾
121727

Basic device PKE12

1 pc.
 

PKE12/XTU-1.2²⁾
121731

1 pc.
 

PKE12/AK/XTU-1.2²⁾
158242

Basic device PKE12
Basic device PKE32

PKE-XTUA-4¹⁾
121728

Basic device PKE12
Basic device PKE32

PKE12/XTU-4²⁾
121732

PKE12/AK/XTU-4²⁾
158244

Basic device PKE12
Basic device PKE32

PKE-XTUA-12¹⁾
121729

Basic device PKE12
Basic device PKE32

PKE12/XTU-12²⁾
121733

PKE12/AK/XTU-12²⁾
158243

Basic device PKE32

PKE-XTUA-32¹⁾
121730

Basic device PKE32

PKE32/XTU-32²⁾
121734

PKE32/AK/XTU-32²⁾
158246

For use with

Trip block system protection
Extended

For use with
Connection to SmartWire-DT
with PKE-SWD-CP

Complete device with
standard handle

Std. pack

Type
Article no.

Std. pack

Type
Article no.

Std. pack

Basic device PKE32

1 pc.

PKE-XTUACP-36
168795

Basic device PKE32

1 pc.

PKE32/XTUCP-36
168972

1 pc.

 in conjunction with SmartWire-DT module → page 3/24





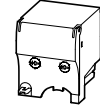
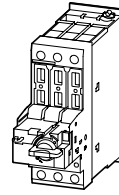



Motor-protective circuit breaker PKE, system circuit breaker PKE



3





Motor Power P kW	Rated motor current AC-3					Overload release setting range I_r A	Basic device with standard knob Basic device with AK lockable rotary handle Type Article no.	Std. pack	Trip block motor protection Standard Type Article no.
	220 V	380 V	440 V	500 V	660 V				
	230 V	400 V			690 V				
	240 V	415 V							

Motor-protective circuit breaker PKE, type "1" and "2" coordination

Motor Power (kW)	220 V	380 V	440 V	500 V	660 V	690 V	Setting range	Basic device with standard knob PKE65 ²⁾ Article no.	Std. pack	Trip block system protection Standard PKE-XTUW-32 ¹⁾ Article no.
2.2	8.7	—	—	—	—	—	8 - 32	PKE65 ²⁾ 138258	1 pc.  	PKE-XTUW-32 ¹⁾ 138261
3	11.5	—	—	—	—	—				
4	14.8	8.5	—	—	—	—		PKE65/AK ²⁾ 158247	1 pc.  	
5.5	19.6	11.3	10.2	9	—	—				
7.5	26.4	15.2	13.8	12.1	8.8	—				
11	—	21.7	19.8	17.4	12.6	—				
15	—	29.3	26.6	23.4	17	—				
18.5	—	—	—	28.9	20.9	—				
22	—	—	—	—	23.8	—				
30	—	—	—	—	32	—				
5.5	19.6	—	—	—	—	—	16 - 65	PKE65 ²⁾ 138258	1 pc.  	PKE-XTU-65 ¹⁾ 138259
7.5	26.4	—	—	—	—	—				
11	38	21.7	19.7	17.4	—	—		PKE65/AK ²⁾ 158247	1 pc.  	
15	51	29.3	26.6	23.4	17	—				
18.5	63	36	32.9	28.9	20.9	—				
22	—	41	37.4	33	23.8	—				
30	—	55	50.3	44	32	—				
37	—	—	61.4	54	39	—				
45	—	—	—	65	47	—				
55	—	—	—	—	58	—				

Rated uninterrupted current I_u A	Settings range		Basic device with standard handle Type Article no.	Std. pack	Trip block system protection Standard Type Article no.
	Overload trigger I_r A	short-circuit release I_{rm} A			
					

System protective circuit breakers PKE

Rated current (A)	Settings range	Short-circuit release (A)	Basic device with standard handle PKE65 ²⁾ Article no.	Std. pack	Trip block system protection Standard PKE-XTUWCP-36 Article no.
36	15 - 36	75 - 288	PKE65 ²⁾ 138258	1 pc.  	PKE-XTUWCP-36 168796
65	30 - 65	150 - 520	PKE65 ²⁾ 138258	1 pc.  	PKE-XTUCP-65 168798

Information relevant for export to North America



1)	
Product standards	UL508; CSA-C22.2 No.14; IEC60947-4-1; CE marking
UL File No.	E36332
UL CCN	NLRV
CSA File No.	165628
CSA Class No.	3211-05
NA Certification	UL listed, CSA certified

Motor-protective circuit breaker PKE, system circuit breaker PKE

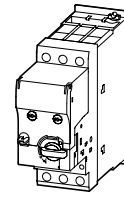
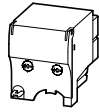

For use with

Trip block motor protection Extended

For use with Connection to SmartWire-DT with PKE-SWD-SP

Complete device with standard handle
Complete device with AK lockable rotary handle

Std. pack

Type
Article no.

→ page 3/24

Std. pack

Type
Article no.

Std. pack

Basic device PKE65

1 pc.



PKE-XTUWA-32¹⁾
138262

Basic device PKE65

1 pc.



PKE65/XTUW-32²⁾
138517

1 pc.



Basic device PKE65

PKE65/AK/XTUW-32²⁾
158249

1 pc.



PKE-XTUA-65¹⁾
138260

Basic device PKE65

1 pc.



PKE65/XTU-65²⁾
138516

1 pc.



PKE65/AK/XTU-65²⁾
158248

For use with

Trip block system protection Extended

For use with Connection to SmartWire-DT with PKE-SWD-CP

Complete device with standard handle

Std. pack

Type
Article no.

Std. pack

Type
Article no.

Std. pack

Basic device PKE65

1 pc.

PKE-XTUWACP-36
168797

Basic device PKE65

1 pc.

PKE65/XTUWCP-36
168973

1 pc.

Basic device PKE65

PKE-XTUACP-65
168799

Basic device PKE65

PKE65/XTUCP-65
168974



²⁾
Product standards
UL File No.
UL CCM
CSA File No.
CSA Class No.
NA Certification

IEC/EN 60947-4-1; UL 60947-4-1; CSA-C22.2 No. 60947-4-1-14; CE marking
E36332
NLRV
165628
3211-05
UL listed, CSA certified

in conjunction with SmartWire-DT module → page 3/24

NHI...-PKZO standard auxiliary contact

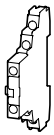
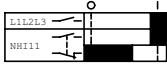
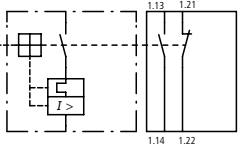
3

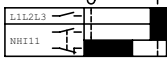
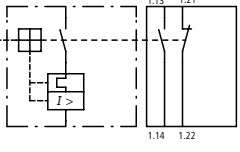
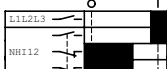
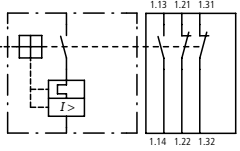
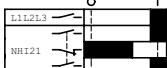
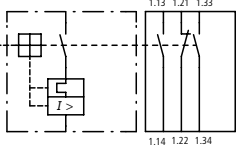
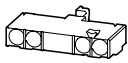
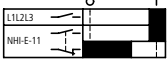
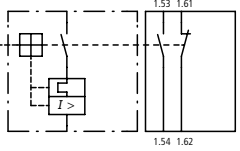
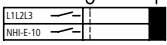
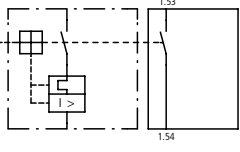
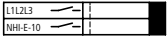
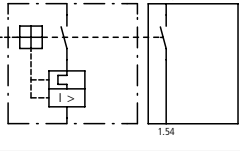
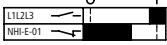
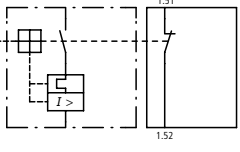
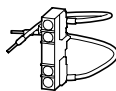
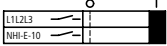
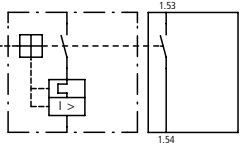
Terminal type	Contact configuration	Contact diagram	Circuit symbol	For use with	Type Article no.	Std. pack	
Standard auxiliary contact							
for motor-protective circuit breakers							
	Screw terminals	1 N/O 1 N/C			PKZM01 PKZM0 PKZM4 PKZM0-T PKM0 PKE	NHI11-PKZO 072896	1 pc. 
	Spring-clamp terminals	1 N/O 1 N/C				NHI11-PKZO-C 229680	
	Screw terminals	1 N/O 2 N/C				NHI12-PKZO 072895	
	Screw terminals	2 N/O 1 N/C				NHI21-PKZO 072894	
	Screw terminals	1 N/O 1 N/C				NHI-E-11-PKZO 082882	
	Screw terminals	1 N/O -				NHI-E-10-PKZO 082884	
	Spring-loaded terminals	1 N/O -				NHI-E-10-PKZO-C 229681	
Spring-loaded terminals	- 1 N/C				NHI-E-01-PKZO-C 229682		
	Standard auxiliary contact with cable						
	-	1 N/O -			DILM	NHI-E-10L-PKZO 107040	5 pcs.

Notes

Information relevant for export to North America



Can be fitted to the right of:
 Motor-protective circuit breaker, transformer-protective circuit breaker,
 Motor-protective circuit breaker for start combinations
 Apart from MSC-R...
 Can be combined with:
 Trip-indicating auxiliary contact AGM, HI-E...

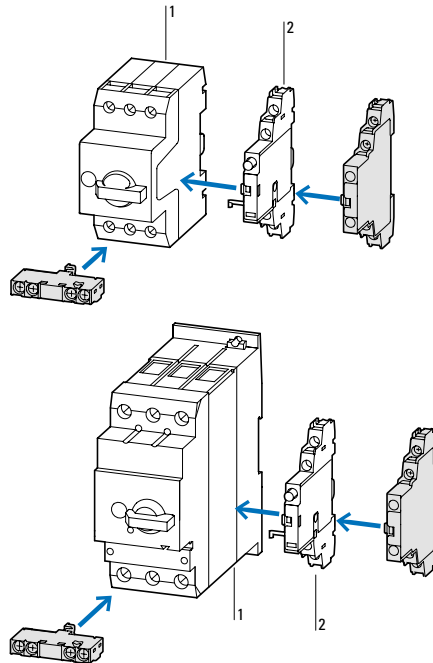

Product standards	UL 508; CSA-C22.2 No. 14; IEC60947-4-1; CE marking
UL File No.	E36332
UL CCN	NLRV
CSA File No.	165628
CSA Class No.	3211-05
NA Certification	UL Listed, CSA certified

Can be fitted to the motor-protective circuit breaker, transformer-protective circuit breaker, motor-protective circuit breaker for starter combinations from series no. 01. 45 mm (PKZM0 and PKZM01) or 55 mm (PKZM4) widths of the motor-protective circuit breaker remain unchanged. NHI-E...-PKZO-C not usable for MSC...-type motor-starter combinations.

Accessories

- 1 Motor-protective circuit breaker
- 2 Trip-indicating auxiliary contact
- Further accessories

Page

- 3/4
- 3/16
- 3/28

with connection cable AWG18 blue,
 for connection to SmartWire module
 for DILM.

Trip indicating signal AGM, auxiliary contact VHI, voltage release A-PKZ0, U-PKZ0

3

Contact configuration	Contact diagram	Circuit symbol	For use with	Type Article no.	Std. pack
<p>N/O = normally open N/C = normally closed contact</p>					
<p>Trip-indicating auxiliary contact</p> <p>for motor-protective circuit breakers</p>					
2 x 1 N/O			PKZM0 PKZM4 PKZM0-T PKM0 PKZM01 PKE	AGM2-10-PKZ0 072898	2 pcs.
–			PKZM0 PKZM4 PKZM0-T PKM0 PKZM01 PKE	AGM2-01-PKZ0 072899	2 pcs.
<p>Early-make auxiliary contact</p> <p>for motor-protective circuit breakers</p>					
2 N/O			PKZM0 PKZM0-T PKM0 PKZM4	VHI20-PKZ0 203595	2 pcs.
2 N/O			PKZM01	VHI20-PKZ01 278495	5 pcs.
<p>Shunt release</p>					
–	–		PKZM0 PKZM4 PKZM0-T PKM0 PKZM01 PKE	A-PKZ0(230V50HZ) 073187 A-PKZ0(24VDC) 073200	2 pcs.
<p>Undervoltage release</p>					
–	–		PKZM0 PKZM4 PKZM0-T PKM0 PKZM01 PKE	U-PKZ0(230V50HZ) 073135 U-PKZ0(24VDC) 157862	2 pcs.

Notes

Information relevant for export to North America



Can be retrofitted on the right side of motor-protective circuit breakers

Can be combined with standard auxiliary contact:
 NHI11-PKZ0
 NHI12-PKZ0
 NHI21-PKZ0
 NHI-E-...

Differential indication:
 a) General trip indication (overload)
 b) Short-circuit release

Short-circuits indicated locally by means of a red indicator that can be manually reset

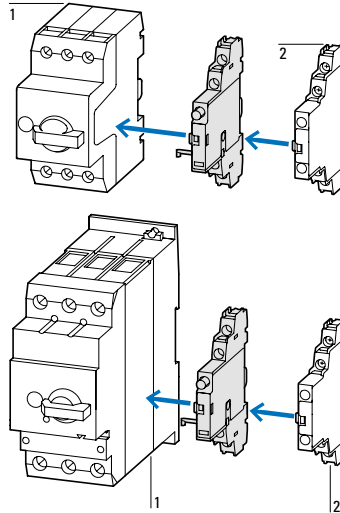

Product standards	UL 508; CSA-C22.2 No. 14; IEC60947-4-1; CE marking
UL File No.	E36332
UL CCN	NLRV
CSA File No.	165628
CSA Class No.	3211-05
NA Certification	UL Listed, CSA certified

Can be fitted to front on motor-protective circuit breaker, 45 mm width of the motor-protective circuit breaker remains unchanged.

For early energization of undervoltage release, e.g. in emergency-stop circuits to EN 60204.
 VHI20-PKZ0 cannot be used in combination with PKZ0-X(R)H(-M), MSC-... and PKZM0-X...M12.

Accessories

Page

- 1 Motor-protective circuit breaker → 3/4
- 2 Standard auxiliary contact → 3/14

Can be fitted to left side of the motor-protective circuit breaker

Cannot be combined with undervoltage release U-PKZ0
 DC: Short-time operation 5 s

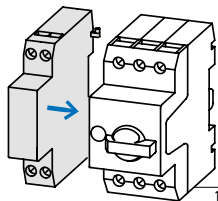

Product standards	UL 508; CSA-C22.2 No. 14; IEC60947-4-1; CE marking
UL File No.	E36332
UL CCN	NLRV
CSA File No.	165628
CSA Class No.	3211-05
NA Certification	UL Listed, CSA certified

Can be fitted to the left of:

Motor protection switch
 cannot be combined with:
 A-PKZ0 shunt release
 When combined with circuit breaker can be used as emergency-stop device to IEC/EN 60204

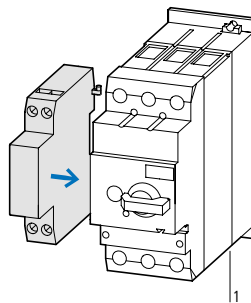

Product standards	UL 508; CSA-C22.2 No. 14; IEC60947-4-1; CE marking
UL File No.	E36332
UL CCN	NLRV
CSA File No.	165628
CSA Class No.	3211-05
NA Certification	UL Listed, CSA certified

Accessories

Page

- 1 Motor-protective circuit breaker → 3/4
- Further actuating voltages → 3/40

Engineering

3

Housing

Accessories

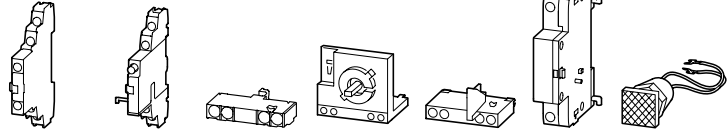

Type	Degree of protection	Grip color	NHI...-PKZ0	AGM2...-PKZ0	NHI-E...-PKZ0	VHI...-PKZ0	VHI...-PKZ01	U-PKZ0 or A-PKZ0	L-PKZ0 ²⁾
------	----------------------	------------	-------------	--------------	---------------	-------------	--------------	------------------	----------------------

Surface mounting enclosure

Motor-protective circuit breakers PKZM01

		CI-PKZ01	IP40	-	-	-	✓	-	✓	✓
		CI-PKZ01-NA							✓	✓
									✓	✓
									✓	✓
		CI-PKZ01-G	IP65	-	-	✓	-	-	✓	✓
		CI-PKZ01-NA-G						✓	✓	✓
									✓	✓
									✓	✓
		CI-PKZ01-PVT	IP65	red-yellow	-	-	✓	-	✓	✓
		CI-PKZ01-NA-PVT							✓	✓
		CI-PKZ01-PVS							✓	✓
		CI-PKZ01-NA-PVS							✓	✓
		CI-PKZ01-SVB	IP65	-	-	✓	-	-	✓	✓
		CI-PKZ01-NA-SVB							✓	✓
		CI-PKZ01-SVB-V	IP65	-	-	-	-	✓ ¹⁾	✓	✓
		CI-PKZ01-NA-SVB-V							✓	✓

Motor-protective circuit breakers PKZM0

		CI-K2-PKZ0	IP41	-	✓	-	✓	-	✓	✓
		CI-K2H-PKZ0							✓	✓
		CI-K2-PKZ0-NA							✓	✓
		CI-K2-PKZ0-G	IP65	black	✓	-	✓	-	✓	✓
		CI-K2H-PKZ0-G							✓	✓
		CI-K2-PKZ0-NA-G							✓	✓
		CI-K2-PKZ0-GR	IP65	red-yellow	✓	-	✓	-	✓	✓
		CI-K2H-PKZ0-GR							✓	✓
		CI-K2-PKZ0-NA-GR							✓	✓
		CI-PKZ0-M	IP40	-	✓	-	✓	-	-	✓
									✓	✓
		CI-PKZ0-GM	IP55	black	✓	-	✓	-	-	✓
									✓	✓
		CI-PKZ0-GRM	IP55	red-yellow	✓	-	✓	-	-	✓
									✓	✓

Motor-protective circuit breaker PKZM0 + early-make auxiliary contact VHI-PKZ0

		CI-K2-PKZ0-GV	IP65	black	✓	-	-	✓	-	✓
		CI-K2H-PKZ0-GV							✓	✓
		CI-K2-PKZ0-NA-GV							✓	✓
		CI-K2-PKZ0-GRV	IP65	red-yellow	✓	-	-	✓	-	✓
		CI-K2H-PKZ0-GRV							✓	✓
		CI-K2-PKZ0-NA-GRV							✓	✓
		CI-PKZ0-GVM	IP55	black	✓	-	-	✓	-	✓
									✓	✓
		CI-PKZ0-GRVM	IP55	red-yellow	✓	-	-	✓	-	✓
									✓	✓

Notes The combination possibilities of circuit breakers in an enclosure with accessory modules are identified by a ✓.

¹⁾ Always necessary

²⁾ Cannot be used for UL/CSA

Housing

Accessories

Type

Type

Protection rating Grip color

NHI..-PKZO AGM2..-PKZO NHI-E.-PKZO VHI..-PKZO VHI..-PKZO1 U-PKZO or A-PKZO L-PKZO

Surface mounting enclosure

Motor-protective circuit breakers PKZM4

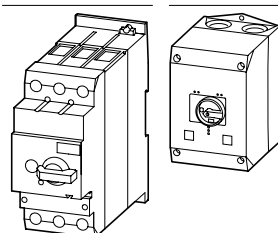

Type	Protection rating	Grip color	NHI..-PKZO	AGM2..-PKZO	NHI-E.-PKZO	VHI..-PKZO	VHI..-PKZO1	U-PKZO or A-PKZO	L-PKZO
CI-K4-PKZ4-G	IP65	black	✓	✓	✓	-	-	✓	✓
CI-K4-PKZ4-GR	IP65	red-yellow	✓	✓	✓	-	-	✓	✓
CI-K4-PKZ4-NA-GR			✓	✓	-	✓	-	✓	✓

Installation housing

Motor-protective circuit breakers PKZM01

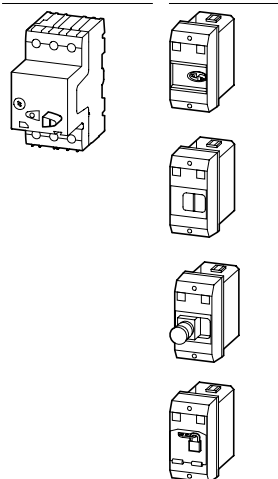

Type	Protection rating	Grip color	NHI..-PKZO	AGM2..-PKZO	NHI-E.-PKZO	VHI..-PKZO	VHI..-PKZO1	U-PKZO or A-PKZO	L-PKZO
E-PKZ01	IP40	-	-	-	✓	-	-	✓	✓
			✓	-	✓	-	✓	-	✓
E-PKZ01-G	IP65	-	-	-	✓	-	✓	✓	✓
			✓	-	✓	-	✓	-	✓
E-PKZ01-PVT	IP65	red-yellow	-	-	✓	-	-	✓	✓
E-PKZ01-PVS			-	-	-	-	✓	✓	✓
E-PKZ01-SVB	IP65	-	-	-	✓	-	-	✓	✓
E-PKZ01-SVB-V	IP65	-	-	-	-	-	✓ ¹⁾	✓	✓

Motor-protective circuit breakers PKZM0

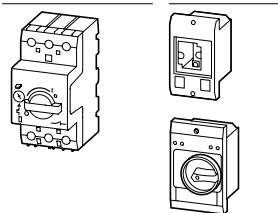

Type	Protection rating	Grip color	NHI..-PKZO	AGM2..-PKZO	NHI-E.-PKZO	VHI..-PKZO	VHI..-PKZO1	U-PKZO or A-PKZO	L-PKZO
E-PKZO	IP40	-	✓	-	-	-	-	-	✓
			-	-	-	-	-	✓	✓
E-PKZO-G	IP55	black	✓	-	✓	-	-	-	✓
			-	-	✓	-	-	✓	✓
E-PKZ1-GR	IP55	red-yellow	✓	-	✓	-	-	-	✓
			-	-	✓	-	-	✓	✓











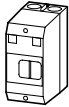

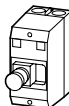
Notes The combination possibilities of circuit breakers in an enclosure with accessory modules are identified by a ✓.

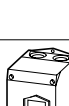

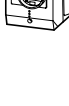



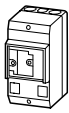

¹⁾ Always necessary
²⁾ Cannot be used for UL/CSA

Insulated enclosure for fitting CI-PKZ01..., CI-K2...-PKZ0...

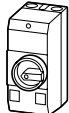
Product selection



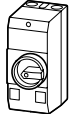
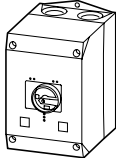





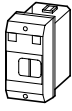

3

	Protection rating	For use with	Type Article no.	Std. pack	Notes
Insulated enclosures for surface mounting					
for PKZM01 motor-protective circuit breakers					
	IP40	PKZM01 +NHI-E or VHI-PKZ01 +U or A or NHI +L (2 pcs.)	CI-PKZ01 281403	1 pc.	Integrated terminal for PE(N) connection, two M25 cable entries at top and at bottom.
	IP65		CI-PKZ01-G 281404		
	IP65	PKZM01 +NHI-E and +U or A +L (2 pcs.)	CI-PKZ01-SVB 281405		
	IP65		CI-PKZ01-SVB-V 281944		
	IP65		CI-PKZ01-PVT 281406		
	IP65		CI-PKZ01-PVS 281407		
	as unit	PKZM01	CI-PKZ01-X 289934		
for PKZM01 motor-protective circuit breakers					
	IP41 with vertical mounting IP40, if tilted 90° left/right	PKZM0-... +NHI or AGM +U or A +NHI-E +L-PKZO (2 pcs.)	CI-K2-PKZ0¹⁾ 219653 CI-K2H-PKZ0²⁾ 260362	1 pc.  	M25 metric cable entry knockout, top and bottom CI-K2 insulated enclosure incl. N and PE terminal
	IP65		CI-K2-PKZ0-G¹⁾ 219654 CI-K2H-PKZ0-G²⁾ 260363		¹⁾ Push-through cable entry diaphragm top, bottom, in the back plate and as a control cable entry. ²⁾ Without the push-through cable entry diaphragm, hard knockouts can be removed as required.
	IP65		CI-K2-PKZ0-GR¹⁾ 219655 CI-K2H-PKZ0-GR²⁾ 260364		
	IP65	PKZM0-... and VHI +NHI or AGM +U or A +L-PKZO (2 pcs.)	CI-K2H-PKZ0-GRV²⁾ 260365 CI-K2H-PKZ0-GV²⁾ 260366		

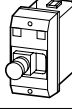
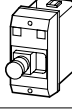
	Protection rating	For use with	Type Article no.	Std. pack	Notes
Insulated enclosures for surface mounting					
for PKZM01 motor-protective circuit breakers					
	Cover with aperture dimensioned to accommodate front of breaker	IP40	PKZM0-... +NHI or U or A +L-PKZ0 (2 pcs.)	CI-PKZ0-M 267083	1 pc.   Integrated terminal for PE(N) connection, two M25 cable entries at top and at bottom.
	With black-grey rotary handle	IP55	PKZM0-... +NHI-E	CI-PKZ0-GM 260089	
	With red-yellow rotary knob, for use as EMERGENCY STOP switch in accordance with EN 60204	IP55	+NHI or U or A +L-PKZ0 (2 pcs.)	CI-PKZ0-GRM 260104	
for PKZM0 motor-protective circuit breakers with early-make VHI auxiliary contacts					
	With black-grey rotary handle	IP65	PKZM0-... and VHI +NHI or AGM	CI-K2-PKZ0-GV 219657	1 pc.   M25 metric cable entry knockout, top and bottom
	With red-yellow rotary knob, for use as EMERGENCY STOP switch in accordance with EN 60204	IP65	+U or A +L (2 pcs.)	CI-K2-PKZ0-GRV 219656	Cable push-through membrane top, bottom, in the back plate and as a control line entry. CI-K2 insulated enclosure incl. N and PE terminal.
	With black-grey rotary handle	IP55	PKZM0-... and VHI +U or A (undervoltage or shunt release)	CI-PKZ0-GVM 263526	Integrated terminal for PE(N) connection, two M25 cable entries at top and at bottom.
	With red-yellow rotary knob, for use as EMERGENCY STOP switch in accordance with EN 60204	IP55	+L-PKZ0 (2 pcs.)	CI-PKZ0-GRVM 263525	
for PKZM01 motor-protective circuit breakers					
	With black-grey rotary handle	IP65	PKZM4-... +VHI or NHI-E	CI-K4-PKZ4-G 225524	1 pc.   Metric knockout: Top and bottom: M32...M25 in the back plate: M32...M25
	With red-yellow rotary knob, for use as EMERGENCY STOP switch in accordance with EN 60204	IP65	+NHI and AGM +U or A +L-PKZ0 (2 pcs.)	CI-K4-PKZ4-GR 225525	Control cable entry: M20 CI-K4 insulated enclosure including insulated PE terminal

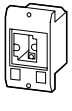







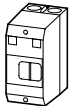

Insulated enclosure for fitting E-PKZ01..., E-PKZ0...

3

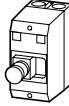
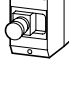
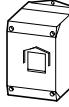
	Protection rating	For use with	Type Article no.	Std. pack	Information relevant for export to North America
Insulated enclosure for flush mounting					
for PKZM01 motor-protective circuit breakers					
Integrated terminal for PE(N) connection					
	Front IP40	PKZM01 +NHI or U or A +NHI-E or VHI +L (2 pcs.)	E-PKZ01 281633	1 pc.  	Product standards UL 508; CSA-C22.2 No. 14; IEC60947-4-1; CE marking UL File No. E36332 UL CCN NLRV CSA File No. 165628 CSA Class No. 3211-05 NA Certification UL Listed, CSA certified
	With actuating membrane Front IP65		E-PKZ01-G 281634		
	Lockable in 0 position Front IP65	PKZM01 +U or A +NHI-E	E-PKZ01-SVB 281635		
	Lockable in 0 position, in combination with VHI-PKZ01 Front IP65		E-PKZ01-SVB-V 281943		
	With emergency-stop maintained mushroom button Front IP65		E-PKZ01-PVT 281636		
	With emergency-stop mushroom button with key release Front IP65		E-PKZ01-PVS 281637		
	For extension with CI/E-PKZ01-X SPD inserts as unit	PKZM01	E-PKZ01-X 289935	1 pc.	
for PKZM01 motor-protective circuit breakers					
Integrated terminal for PE(N) connection					
	Cover with aperture dimensioned to accommodate front of breaker Front IP40	PKZM0-... +NHI or U or A +L-PKZ0 (2 parts)	E-PKZ0 072906	1 pc.  	Product standards UL 508; CSA-C22.2 No. 14; IEC60947-4-1; CE marking UL File No. E36332 UL CCN NLRV CSA File No. 165628 CSA Class No. 3211-05 NA Certification UL Listed, CSA certified
	With black-grey rotary knob Front IP55	PKZM0-... +NHI or U or A +NHI-E +L-PKZ0 (2 pcs.)	E-PKZ0-G 072907		Product standards UL 508; CSA-C22.2 No. 14; IEC60947-4-1; CE marking UL File No. E36332 UL CCN NLRV CSA File No. 165628 CSA Class No. 3211-05 NA Certification UL Listed, CSA certified
	With red-yellow rotary handle, for use as emergency-stop switch in accordance with EN 60204 Front IP55		E-PKZ0-GR 072908		Degree of Protection UL Listed, CSA certified IEC: Front IP55, UL/CSA type: 1, 12, 3R

Insulated enclosure for fitting CI-PKZ01-NA..., CI-K2-PKZO-NA...

3

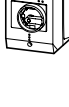
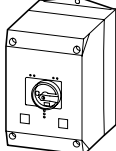
	Protection rating	For use with	Type Article no.	Std. pack	Information relevant for export to North America
Insulated enclosures for surface mounting					
for PKZM01 motor-protective circuit breakers					
Integrated terminal for PE(N) connection					
	IP41	PKZM01 +NHI-E or VHI-PKZ01 +U or A or NHI +L (2 pcs.)	CI-PKZ01-NA 281408	1 pc.  	Product standards UL 508; CSA-C22.2 No. 14; IEC60947-4-1; CE marking E36332 UL File No. UL CCN NLRV CSA File No. 165628 CSA Class No. 3211-05 NA Certification UL Listed, CSA certified Specially designed for NA ✓ Degree of Protection IEC: IP41, UL/CSA type: –
	With actuating membrane IP65	PKZM01 +NHI-E or VHI-PKZ01 +U or A or NHI +L (2 pcs.)	CI-PKZ01-NA-G 281409		Product standards UL 508; CSA-C22.2 No. 14; IEC60947-4-1; CE marking E36332 UL File No. UL CCN NLRV CSA File No. 165628 CSA Class No. NA 3211-05 NA Certification UL Listed, CSA certified Specially designed for NA ✓ Degree of Protection IEC: IP65, UL/CSA type: –
	Lockable in 0 position IP65	PKZM01 +NHI-E or VHI-PKZ01 +U or A +L (2 pcs.)	CI-PKZ01-NA-SVB 281630		Product standards UL 508; CSA-C22.2 No. 14; IEC60947-4-1; CE marking E36332 UL File No. UL CCN NLRV CSA File No. 165628 CSA Class No. NA 3211-05 NA Certification UL Listed, CSA certified Specially designed for NA ✓ Degree of Protection IEC: IP65, UL/CSA type: –
	Lockable in 0 position, in combination with VHI-PKZ01 IP65	PKZM01 +NHI-E +U or A +L (2 pcs.)	CI-PKZ01-NA-SVB-V 281945		
	With emergency-stop maintained mushroom button IP65	PKZM01 +NHI-E or VHI-PKZ01 +U or A +L (2 pcs.)	CI-PKZ01-NA-PVT 281631		
	With emergency-stop mushroom button with key release IP65	PKZM01 +NHI-E or VHI-PKZ01 +U or A +L (2 pcs.)	CI-PKZ01-NA-PVS 281632		
for PKZM01 motor-protective circuit breakers					
Integrated N and PE terminal, base without knockouts					
	Cover with aperture dimensioned to accommodate front of breaker IP41 with vertical mounting IP40 for tilting by 90° left/right	PKZM0-... +NHI or AGM +U or A +NHI-E +L-PKZO (2 pcs.)	CI-K2-PKZO-NA 265363	1 pc.  	Product standards UL 508; CSA-C22.2 No. 14; IEC60947-4-1; CE marking E36332 UL File No. UL CCN NLRV CSA File No. 165628 CSA Class No. 3211-05 NA Certification UL Listed, CSA certified Specially designed for NA ✓ Degree of Protection IEC: IP55, UL/CSA type: 1, 12, 3R
	With black-grey rotary knob IP55	PKZM0-... +NHI or U or A +L-PKZO (2 pcs.)	CI-K2-PKZO-NA-G 262680		
	With red-yellow rotary handle, for use as emergency-stop switch in accordance with EN 60204 IP55	PKZM0-... +NHI-E +L-PKZO (2 pcs.)	CI-K2-PKZO-NA-GR 262681		
For PKZM0 motor-protective circuit breakers with early-make auxiliary contacts					
Integrated N and PE terminal, base without knockouts					
	With black-grey rotary knob IP55	PKZM0-... +VHI... + U... +L-PKZO (2 pcs.)	CI-K2-PKZO-NA-GV 262682		
	With red-yellow rotary handle, for use as emergency-stop switch in accordance with EN 60204 IP55	PKZM0-... +VHI... + U... +L-PKZO (2 pcs.)	CI-K2-PKZO-NA-GRV 262683		
for PKZM01 motor-protective circuit breakers					
Integrated N and PE terminal, base without knockouts					
	With red-yellow rotary knob, for use as EMERGENCY STOP switch in accordance with EN 60204 IP65	M4-... +VHI or NHI-E +NHI and AGM +U or A +L-PKZO (2 pcs.)	CI-K4-PKZ4-NA-GR 113743		

Current limiter CL-PKZO, function element SWD, overload relay module PKE-XZMR...

3

Circuit symbol For use with

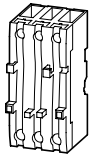

Current limiter

Motor-protective circuit breaker, non-auto-protected in order to increase switching capacity

Max. Rated operating voltage $U_p = 690$ V, rated uninterrupted current $I_u = 63$ A.

For individual and group protection.

For group protection and in combination with PKZM4, order additional BK25/3 extension terminal if required.

Mounting next to or behind the motor-protective circuit breaker.

PKZM0: 16 - 32 A, 150 kA/440 V

PKZM4: 16 - 63 A, 100 kA/400 V

PKZM4: 16 - 63 A, 10 kA/690 V

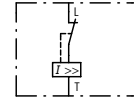

PKZM0
PKZM4
PKE
PKM0

Function elements

SmartWire-DT PKE module for motor-starter combinations

For connecting PKE motor-starter combination MSC-DEA... with PKE-XTUA-... trip blocks with a rated motor output of 15 kW/400 V to SmartWire-DT.

Motor protection, motor protection for heavy starting duty

Connecting cable between module and trip block PKE-XTUA-... included as standard.

Push in terminals

—

DILM(C)7... - DILM(C)32
MSC-DEA

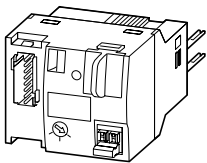

SmartWire DT PKE module for motor-protective circuit breaker

For connecting the motor-protective circuit breaker with PKE-XTU(W)A-... trip blocks (motor protection) to SmartWire-DT.

—

PKE12
PKE32
PKE65

SmartWire-DT PKE module for system protection circuit breakers

For connecting the PKE circuit breaker with PKE-XTU(W)ACP-... trip blocks to SmartWire-DT.

System protection

—

PKE32
PKE65

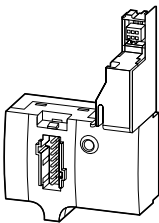

Communication cables

For connecting the PKE to DS7-SWD

6-pole

Prefabricated with two plugs

—

DS7...SWD

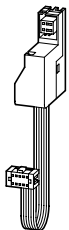

Overload relay module







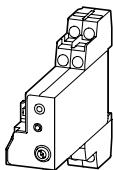

Contact configuration: 1 normally open (NO), 1 normally closed (NC)



PKE12, PKE32, PKE65
with XTUA trip block from
release 04 and higher







Current limiter CL-PKZO, function element SWD, overload relay module PKE-XZMR...

Type Article no.	Std. pack	Notes	Information relevant for export to North America	
				
CL-PKZO 082881	1 pc. 		Product standards UL File No. UL CCN CSA File No. CSA Class No. NA Certification	UL 508; CSA-C22.2 No. 14; IEC60947-4-1; CE marking E36332 NLRV 165628 3211-05 UL listed, CSA certified
PKE-SWD-32 126895	 4 pcs. 	Mounting on DILM contactor with 24 V DC control voltage. One module per contactor and PKE necessary. Additional SWD contactor module required for actuation of reversing starter. 1 electrical interlock for the surface mounting of reversing starters. 1-0-A switch for manual or automatic operation. Selectable overload relay function (ZMR) for switching off the contactor on overload. Wiring sets DILM 12-XRL and PKZM0-XRM12 cannot be used. If the contactor coils have a current consumption > 3 A (UL/CSA > 2 A), use additional power feeder module. A2 connections must not be linked. → For messages and commands, see data sheet in the online catalog	Product standards UL File No. UL CCN CSA File No. CSA Class No. NA Certification	UL508; CSA-C22.2 No. 14; IEC60947-4-1; CE marking E29184 NKCR 165628 3211-07 UL listed, CSA certified
PKE-SWD-SP 150614	 1 pc. 	→ For messages and commands, see data sheet in the online catalog		
PKE-SWD-CP 172735	 1 pc.	→ For messages and commands, see data sheet in the online catalog	-	-
PKE32-COM 168970	 1 pc.	-	-	-
PKE-XZMR(230V50HZ) 173416	1 pc.	-		
PKE-XZMR(24VDC) 173425				



Door coupling handle PKZ0(E)-XH..., terminal cover HB-PKZ4

3



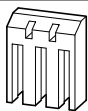

			For use with	Type Article no.	Std. pack	Notes
Door coupling handles						
Protection type IP65 UL/CS Type 4X / Type12						
	For use as main switch to IEC/EN 60204	black	PKZM0 PKZM4	PKZ0-XH¹⁾ 106132	1 pc.  	Plug-fit extension shaft PKZ0-XAH can be cut to desired length for mounting depths of 100 – 240 mm. Carrier with extension shaft included in delivery. With ON/OFF switch position and “+” (tripped), lockable With 3 padlocks, 4 - 8 mm hasp thickness. Cannot be used in combination with VHI20-PKZ0. ZFS... (except for ZFS-(L)TS-NZM) add-on front plates can be used.
	For use as a main switch with emergency-stop function, to EN 60204	red-yellow	PKZM0 PKZM4	PKZ0-XRH¹⁾ 106133		
	For use as a main switch to EN 60204 in MCC power distribution systems and with PKZM0 installed when rotated by 90°	black	PKZM0 PKZM4	PKZ0-XH-MCC¹⁾ 106136		
	For use as a main switch with emergency-stop function to EN 60204 in MCC distribution boards and with PKZM0 installed when rotated by 90°	red-yellow	PKZM0 PKZM4	PKZ0-XRH-MCC¹⁾ 106137		
	for use as a main switch to EN 60204 in MCC distribution boards and with PKZM0 installed when rotated by 90°	black	PKZM0	PKZ0-XHT-MCC 164297	1 pc.	
	For use as a main switch with emergency-stop function to EN 60204 in MCC distribution boards and with PKZM0 installed when rotated by 90°	red-yellow	PKZM0	PKZ0-XRHT-MCC 164298		
	For use as a main switch to EN 60204 in MODAN	black	PKZM0	PKZ0-XHM 106135		
	For use as a main switch to EN 60204 in MCC power distribution systems and with PKE installed when rotated by 90°	black	PKE	PKE-XHT-MCC 164299		
	For use as a main switch with emergency-stop function to EN 60204 in MCC distribution boards and with PKE installed when rotated by 90°	red-yellow	PKE	PKE-XRHT-MCC 164350		
	For use as main switch to IEC/EN 60204	black	PKE	PKE-XH¹⁾ 142416	1 pc.  	
	for use as a main switch with emergency-stop function, to EN 60204	red-yellow	PKE	PKE-XRH¹⁾ 142417		
	For use as a main switch to EN 60204 in MCC power distribution systems and with PKE installed when rotated by 90°	black	PKE	PKE-XH-MCC¹⁾ 142418		
	for use as a main switch with emergency-stop function to EN 60204 in MCC distribution boards with PKE installed when rotated by 90°	red-yellow	PKE	PKE-XRH-MCC¹⁾ 142419		

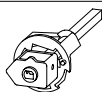

Terminal cover						
	For increasing the degree of protection of the PKZM4 to IP2X	–	PKZM4 PKE65	HB-PKZ4²⁾ 256581	1 pc.  	Suitable for connecting cables with a max. external diameter of 9.5 mm



Pluggable extension shaft						
	–	–	PKZM0 PKZM4	PKZ0-XAH¹⁾ 106134	1 pc.  	Actuator not included
	–	–		PKZ0-XAS 151193	20 pcs.	
	–	–		PKZ0-XASM 177266		











Notes

Information relevant for export to North America



Product standards	UL 508; CSA-C22.2 No. 14; IEC60947-4-1; CE marking
UL File No.	E36332
UL CCN	NLRV
CSA File No.	165628
CSA Class No.	3211-05
NA Certification	UL Listed, CSA certified
Degree of Protection	IEC: IP65, UL/CSA type: 4X, 12

Product standards	UL 508; CSA-C22.2 No. 14; IEC60947-4-1; CE marking
UL File No.	E36332
UL CCN	NLRV
CSA File No.	165628
CSA Class No.	3211-06
NA Certification	UL-listed, CSA-certified

	Protection rating	For use with	Type Article no.	Std. pack	Information relevant for export to North America 
Insulated enclosures, accessories					
padlocking feature For max. 3 padlocks with 3 - 6 mm hasp thickness, for use as a main switch to EN 60204					
	-	CI-K2-PKZ0-G(R)(V)	SVB-PKZ0-CI 035129	3 pcs. 	Product standards UL 508; CSA-C22.2 No. 14; IEC60947-4-1; CE marking UL File No. E36332 UL CCN NLRV CSA File No. 165628 CSA Class No. 3211-05 NA Certification UL Listed, CSA certified
		CI-PKZ0-G(R)(V)M	SVB-PKZ0-E 035127		
	-	E-PKZ0-G(R)	SVB-PKZ4-CI 225526	1 pc.	
Neutral terminal For connecting a 5th cable					
	flexible, 1 mm ² - 4 mm ²	CI-K2-PKZ0-...	K-CI-K1/2 207451	20 pcs.	UL/CSA certification not required
	-	E-PKZ0(-G)(-GR) E-PKZ01(-G)	N-PKZ0 082160	20 pcs	
Units for insulated enclosure for PKZ01					
Combinable with CI-PKZ01-X and E-PKZ01-X					
	With notch	Front IP40	PKZM0-... +NHI or AGM +U or A +NHI-E +L-PKZ0 (2 pcs.)	CI/E-PKZ01-XG 289981	1 pc.
		With operating membrane	Front IP65	PKZM01 +NHI-E or VHI-PKZ01 +U or A or NHI +L (2 pcs.)	CI/E-PKZ01-XG 289936
		Lockable in 0 position	PKZM01 +NHI-E +U or A +L (2 pcs.)	CI/E-PKZ01-XSVB 289939	
	With Emergency-Stop mushroom-headed pushbutton, maintained	PKZM01 +NHI-E or VHI-PKZ01 +U or A +L (2 pcs.)	CI/E-PKZ01-XPVT 289937		
	with EMERGENCY STOP mushroom button, released by key	PKZM01 +NHI-E or VHI-PKZ01 +U or A +L (2 pcs.)	CI/E-PKZ01-XPVS 289938		
	Lockable in 0 position, in combination with VHI-PKZ01	PKZM01 VHI-PKZ01 +U or A +L (2 pcs.)	CI/E-PKZ01-XSVB-V 289980		

Accessories for insulated enclosure

3

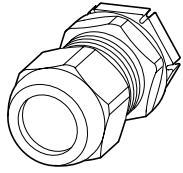



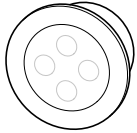







Cable entry	Hole diameter mm	External diameter of cable mm	Type Article no.	Std. pack
Metric cable glands to EN 50262				
<ul style="list-style-type: none"> • With lock nut and integrated strain relief • IP68 up to 5 bar 				
M20	20.5	6 - 13	V-M20 206910	20 pcs.
M25	25.5	9 - 17	V-M25 206911	
M32	32.5	13 - 21	V-M32 206912	10 pcs.

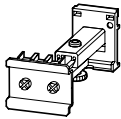

Cable entry	Hole diameter mm	External diameter of cable mm	Type Article no.	Std. pack
Membrane grommets metric				
<ul style="list-style-type: none"> • IP66 • With integral push-through diaphragm 				
M20	20.5	1 - 13	KT-M20 207602	100 pcs.
M25	25.5	1 - 18	KT-M25 207603	
M32	32.5	1 - 25	KT-M32 207604	



Colour	Control voltage U_s V	For use with	Type Article no.	Std. pack
Indicator lights with neon bulb				
White	110 - 230	CI-K2-PKZ0-..., CI-K4-PKZ4, CI-PKZ0(1), E-PKZ0(1)	L-PKZ0(230V) 082151	10 pcs.
White	230 - 400		L-PKZ0(400V) 082152	
White	415 - 500		L-PKZ0(500V) 082153	5 pcs.
Green	110 - 230		L-PKZ0-GN(230V) 082154	10 pcs.
Green	230 - 400		L-PKZ0-GN(400V) 082155	
Green	415 - 500		L-PKZ0-GN(500V) 082156	5 pcs.
Red	110 - 230		L-PKZ0-RT(230V) 082157	10 pcs.
Red	230 - 400		L-PKZ0-RT(400V) 082158	

	Notes	Type Article no.	Std. pack	Information relevant for export to North America		
						
	Telescopic adapters					
	with 35 mm top-hat rail to IEC/EN 60715 for adjusting the mounting depth of rear mounted devices in CI-K... enclosures and cabinets					
	Telescopic clip	Stepless adjustment over scales of 75 - 115 mm Do not use with emergency-stop buttons!	M22-TA 226161	1 pc.  	Product standards IEC/EN 60947-5; UL 508; CSA-C22.2 No. 14-05; CSA-C22.2 No. 94-91; CE marking E29184 UL File No. NKCR UL CCN 012528 CSA File No. 3211-03 CSA Class No. UL Listed, CSA certified NA Certification	
	Lockable rotary handle					
	for locking motor-protective circuit breakers PKZM0, PKZM4 and PKE as a main switch in compliance with EN 60204. Can be padlocked in the 0 position. Hasp thickness: 3 - 6.35 mm					
	Cannot be combined with VHI-PKZ0.	AK-PKZ0 030851	5 pcs.  	Product standards UL 508; CSA-C22.2 No. 14; IEC60947-4-1; CE marking E36332 UL File No. NLRV UL CCN 165628 CSA File No. 3211-05 CSA Class No. UL Listed, CSA certified NA Certification		
	sealing facility					
	To prevent tampering with the overload release and the test function, it can be sealed using industry standard sealing wire For use with motor-protective circuit breakers PKZM0 and PKZM4					
	–	PL-PKZ0 203599	5 pcs.	NA certification request filed for UL and CSA		
	Documentation					
	Motor-protective circuit breakers PKZM0/XTPR...BC1 Overload monitoring of Ex e motors	German/English	MN03402003Z-DE/EN 151986	1 pc.		
	Motor-protective circuit breakers PKZM4-.../XTPR...DC1 Overload monitoring of Ex e motors	German/English	MN03402002Z-DE/EN 151985			
	Motor-protective circuit breakers PKE12, PKE32 and PKE65 Overload monitoring of Ex e motors	German/English	MN03402004Z-DE/EN 134836			





3.4

Motor-protective circuit breakers

Moeller series

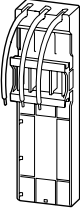
Busbar adapter MSF...

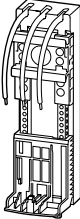
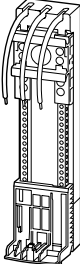
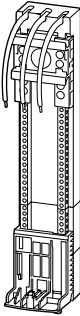
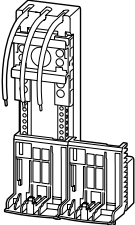

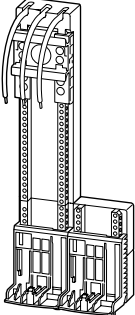
3

Rated operating voltage U_e V	Rated operational current I_e A	Conductor cross-section	Adapter width mm	Adapter length mm	Support rail Number	For use with	Type Article no.	Std. pack
Busbar adapter								
Approved to UL 508								
	690	16	2.5 mm ² AWG 14	45	160	1	PKZM0/PKE12 MSFA0-16 191094	4 pcs.  
	690	32	6 mm ² AWG 10	45	160	1	PKZM0/PKE32 MSFA0-32 191095	
	690	16	2.5 mm ² AWG 14	45	160	1	MSC-D, 16 A MSFAD-16 191096	
	690	25	4 mm ² AWG 12	45	160	1	MSC-D, 25 A MSFAD-25 191097	
	690	32	6 mm ² AWG 10	45	200	1	MSC-D, 32 A MSFAD-32 191098	
	690	16	2.5 mm ² AWG 14	45	240	1	MSC-DS7, 16 A MSFAL-16 191099	
	690	25	4 mm ² AWG 12	90	200	1	MSC-R, 16 A MSFAR-25 191100	2 pcs.  
	690	32	6 mm ² AWG 10	90	240	1	MSC-R, 32 A MSFAR-32 191101	

Width	Poles	Rated operational current	Conductor cross-section	For use with	Type Article no.	Std. pack
mm		I_e A				

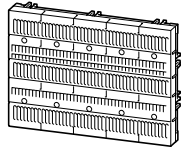
Board



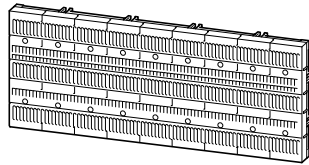

For 4 adapters and feed modules from 45 mm self-extinguishing according to UL 94	225	3	125	MSFA...	MSFB-4-125A 191091	1 pc.  
--	-----	---	-----	---------	------------------------------	--

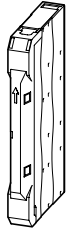

For 8 adapters and feed modules from 45 mm self-extinguishing according to UL 94	405	3	125	MSFA...	MSFB-8-125A 191092	
--	-----	---	-----	---------	------------------------------	--

Feed module



halogen free Self-extinguishing to UL 94 Track resistance CTI 600 Thermal stability to 125 °C Spring-loaded terminal	23	3	80	1.5 - 16 mm ² AWG 14 - 6	MSFB... MSFI-80A 191093	1 pc.  
--	----	---	----	--	--------------------------------------	--

Notes

Information relevant for export to North America



Product standards	EN 61439-1; EN 50581; UL 60947-4-1; CE marking
UL File No.	E300273
UL CCN	NMTR
CSA File No.	E300273
CSA Class No.	NMTR7
NA Certification	UL listed, certified by UL for use in Canada

Further technical data on the power feed systems → data sheet in the online catalog

Busbar adapter BBA ...

3

Rated operating voltage	Cable dimensions	Adapter width	Mounting rail	For use with	Type Article no.	Std. pack	Notes
U_e							
V		mm	Number				

Busbar adapters for PKZ and PKE

For fitting to CU flat busbars with 60 mm between busbar centers, suitable for 5 mm and 10 mm busbar thickness.

Rated operational current 16 A

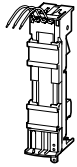

For starter with spring-loaded terminals

690	AWG 14 (2.5 mm ²)	45	2	PKZM0-C + DILMC7 PKZM0-C + DILMC9 PKZM0-C + DILMC12	BBA0C-16 101455	4 pcs.  	To UL 508: $I_g = 12$ A
-----	----------------------------------	----	---	---	---------------------------	--	-------------------------



Rated operational current 25 A

For reversing starters

690	AWG 12 (4 mm ²)	90	1	PKZM0, PKE + 2 x DILM7-01 PKZM0, PKE + 2 x DILM9-01 PKZM0, PKE + 2 x DILM12-01 MSC-R-0,25-M7... - MSC-R-12-M12...	BBA0R-25 101453	2 pcs.  	In combination with individual components PKZM0, PKE and DILM, use reversing starter set PKZM0-XRM12. Completely mounted and tested combination with MSC-R → page 4/28
-----	--------------------------------	----	---	--	---------------------------	--	---

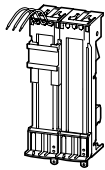

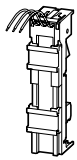

Can be used universally

690	AWG 12 (4 mm ²)	45	2	–	BBA0-25/2TS 101481	4 pcs.  	Mounting rails can be moved within a 1.25 mm grid.
-----	--------------------------------	----	---	---	------------------------------	--	--



For DOL starter

690	AWG 12 (4 mm ²)	45	1	PKZM0, PKE + DILM7 PKZM0, PKE + DILM9 PKZM0, PKE + DILM12 PKZM0, PKE + DILM15 MSC-D(M)-0.25-M7... MSC-D(M)-16-M15...	BBA0-25 101451	4 pcs.  	In combination with individual components PKZM0, PKE and DILM, use DOL starter set PKZM0-XDM12. Completely mounted and tested combination with MSC-D → page 4/2
-----	--------------------------------	----	---	---	--------------------------	--	--

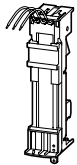

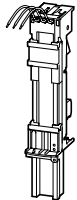

For soft starter

690	AWG 12 (4 mm ²)	45	1	PKZM0, PKE + DS7...004N... PKZM0, PKE + DS7...007N... PKZM0, PKE + DS7...009N... PKZM0, PKE + DS7...012N...	BBA0L-25 142526	1 pc.	–
-----	--------------------------------	----	---	--	---------------------------	-------	---



Rated operational current 32 A

For reversing starters



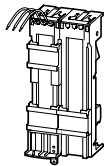







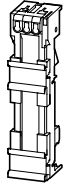

690	AWG 10 (6 mm ²)	90	3	PKZM0, PKE + 2 x DILM17-01 PKZM0 PKE + 2 x DILM25-01 PKZM0, PKE + 2 x DILM32-01	BBA0R-32 101454	2 pcs.  	In combination with individual components PKZM0 and DILM use electrical contact module PKZM0-XM32DE and reversing wiring kit DILM 32-XRL. Completely mounted and tested combination with MSC-R → page 4/28
-----	--------------------------------	----	---	--	---------------------------	--	---

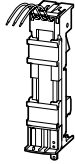
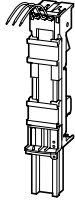
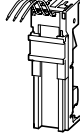

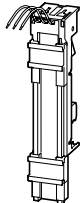
Information relevant for export to North America

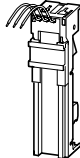

Product standards	UL 508A; CSA-C22.2 No. 14; IEC60439-1; CE marking
UL File No.	E300273
UL CCN	NMTR, NMTR7
NA Certification	UL listed, certified by UL for use in Canada
Max. Voltage rating	600 V AC

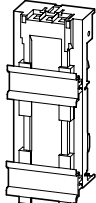
Rated operating voltage	Cable dimensions	Adapter width	Mounting rail	For use with	Type Article no.	Std. pack	Notes
U _e							
V		mm	Number				
Rated operational current 32 A							
Can be used universally							
690	–	45	2	PKZM PKE + DILM...	BBA0-32/2TS-C 116708	4 pcs.  	
							
For DOL starter							
690	AWG 10 (6 mm ²)	45	2	PKZM0 PKE + DILM(C)17 – PKE + DILM(C)32	BBA0-32 101452	4 pcs.  	In combination with individual components PKZM0, PKE and DILM use electrical contact module PKZM0 XM32DE. Completely mounted and tested combination with MSC-D...
							
For soft starter							
690	AWG 10 (6 mm ²)	45	2	PKZM0, PKE + DS7...016..., PKE + DS7...024..., PKE + DS7...032...	BBA0L-32 142527	1 pc.	–
							
For 160-mm adapter system with motor-protective circuit breakers							
690	AWG 10 (6 mm ²)	45	1	PKZM0 PKE	BBA0K-32 142528	1 pc.	–
							
Rated operational current 63 A							
For DOL starter							
690	AWG 8 (10 mm ²)	55	2	PKZM4 PKE65 + DILM(C)x (x = 17, 25, 32, 40, 50, 65)	BBA4L-63 101459	4 pcs.  	For an electrical connection for PKZM4, PKE65 + DILM40 to DILM65: PKZM4-XM65DE can be used.
690	AWG 8 (10 mm ²)	72	2	PKZM4, PKE65 + DILM(C)x (x = 17, 25, 32, 40, 50, 65)	BBA2L-63 101480		
							
For motor protective circuit breakers							
690	AWG 8 (10 mm ²)	55	1	PKZM4, PKE65	BBA4-63 101457	2 pcs.  	–
690	AWG 8 (10 mm ²)	72	1	PKZM4, PKE65	BBA2-63 101458	4 pcs.  	–
							
Rated operational current 80 A							
For DOL starter							
690	AWG 6 (16 mm ²)	72	2	PKZM4, PKE65 + DILMx (x = 7, 9, 12, 15, 17, 25, 32, 38, 40, 50, 65)	BBA2-80/2TS-S 116901	4 pcs.  	Universal adapter for 1, 2 and 3-phase applications, not suitable without additional UL/CSA component.
							

Information relevant for export to North America



Product standards	UL 508A; CSA-C22.2 No. 14; IEC60439-1; CE marking
UL File No.	E300273
UL CCN	NMTR, NMTR7
NA Certification	UL listed, certified by UL for use in Canada
Max. Voltage rating	600 V AC







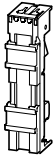

3.4

Motor-protective circuit breakers

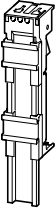
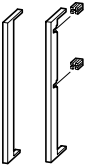
Moeller series

Busbar adapter BBA ..., accessories for busbar adapter











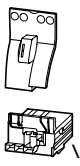

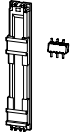
3

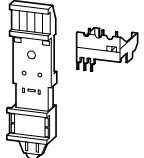
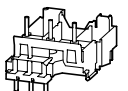
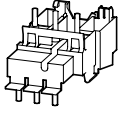
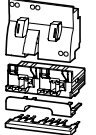
Adapter width mm	Mounting rail Number	For use with	Type Article no.	Std. pack	Notes
Without electrical contact					
Empty module					
	45	2	–	BBA0/2TS-L 101482	4 pcs.   Mounting rails can be moved within a 1.25 mm grid. Can be used to surface-mount reversing starters and star-delta starters.
	55	2	–	BBA4/2TS-L 101483	Mounting rails can be moved within a 1.25 mm grid. Can be used to surface-mount reversing starters and star-delta starters.
	9	–	–	BBA-XSM 101484	10 pcs.   Side-mounted module can be attached on both sides. Can be grouped with busbar adapters in order to extend the mounting width.
	45	–	BBA...	PKZM0-XMR 239364	10 pcs.   Support rail

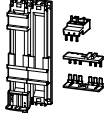
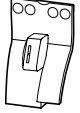
Information relevant for export to North America



Product standards	UL 508A; CSA-C22.2 No. 14; IEC60439-1; CE marking
UL File No.	E300273
UL CCN	NMTR, NMTR7
NA Certification	UL listed, certified by UL for use in Canada
Max. Voltage rating	600 V AC

For use with	Type Article no.	Std. pack	Notes
Wiring sets			
Direct starter			
	PKZM0, PKE + DILM7 PKZM0, PKE + DILM9 PKZM0, PKE + DILM12 PKZM0, PKE + DILM15 DS7-34...SX004... DS7-34...SX007... DS7-34...SX009... DS7-34...SX012...	PKZM0-XDM12 283149	1 pc.   Consists of: • Mechanical connection element for PKZM0 and contactor • Main current wiring between PKZM0 and contactor in tool-less plug connection • Cable Routing As auxiliary contact DILA-XHIT... use → page 1/27 Cannot be combined with NHI-E...PKZ0-C. $U_e \leq 415\text{ V}$
	PKZM4 + DILM40 PKZM4 + DILM50 PKZM4 + DILM65	PKZM4-XDM65 101053	Consists of: • top hat rail adapter plate • Main current wiring between PKZ, PKE and contactor
	PKZM0+DILE(E)M(-G)	MVS-LBM0-EM 220219	1 pc. For the electrical and mechanical connection of motor-protective circuit breaker PKZM0 and contactor DILE(E)M. Use with and without MVS-C45.
		MVS-D0-EM 220230	For modules: PKZM0 motor-protective circuit breaker and DILM contactor.
Direct starter			
Electrical/mechanical connector for screw terminal technology			
	PKZM0, PKE + DILM7 PKZM0, PKE + DILM9 PKZM0, PKE + DILM12 PKZM0, PKE + DILM15	PKZM0-XDM15ME 179646	1 pc.
	PKZM0, PKE + DILM17 PKZM0, PKE + DILM25 PKZM0, PKE + DILM32 PKZM0, PKE + DILM38	PKZM0-XDM32ME 190312	5 pcs.
Reversing starter			
	PKZM0, PKE + DILM7-01 PKZM0, PKE + DILM9-01 PKZM0, PKE + DILM12-01	PKZM0-XRM12 283185	1 pc.   Consists of: • Mechanical connection element for PKZM0 and contactor • Reversing starter main current wiring in tool-less plug connection • Control cables for electrical interlocking in tool-less plug connection: – K1M: A1 -K2M: Z1 – K1M: Z1 -K2M: A1 – K1M: A2 -K2M: A2 • Cable Routing As auxiliary contact DILA-XHIT... use → page 1/27 Cannot be combined with AGM-PKZ0 or NHI...PKZ0 for mounting on the side. $U_e \leq 415\text{ V}$
	PKZM0, PKE + DILM17 PKZM0, PKE + DILM25 PKZM0, PKE + DILM32	PKZM0-XRM32 283189	Consists of: • top hat rail adapter plate • Reversing starter main current wiring
Electric contact module			
	PKZM0, PKE + DILM7 PKZM0, PKE + DILM9 PKZM0, PKE + DILM12 PKZM0, PKE + DILM15 DS7-34...SX004... DS7-34...SX007... DS7-34...SX009... DS7-34...SX012...	PKZM0-XM12DE 112119	126 pcs.   Main current wiring between PKZM0, PKE and contactor in tool-less plug connection. Combined with PKZM0-XM12DM.
	PKZM0, PKE + DILM17 PKZM0, PKE + DILM25 PKZM0, PKE + DILM32 DS7-34...SX016... DS7-34...SX024... DS7-34...SX032...	PKZM0-XM32DE 239349	5 pcs.   • Main current wiring between PKZM0 and contactor • Use only in combination with busbar adapter or top-hat rail adapter plate
	PKZM4 + DILM40 PKZM4 + DILM50 PKZM4 + DILM65	PKZM4-XM65DE 101056	• Main current wiring between PKZM0 and contactor

Top-hat rail adapter plates PKZM...-XC...

3



For use with	Type Article no.	Std. pack	Notes
--------------	---------------------	-----------	-------

Wiring sets

Mechanical link module for DOL starter (replacement)

PKZM0, PKE + DILM7	PKZM0-XM12DM 112118	126 pcs. 	Mechanical link module between PKZM0, PKE and contactor. Combine with PKZM0-XM12DE.
PKZM0, PKE + DILM9			
PKZM0, PKE + DILM12			
PKZM0, PKE + DILM15			
DS7-34...SX004...			
DS7-34...SX007...			
DS7-34...SX009...			
DS7-34...SX012...			

Mechanical link module for reversing starter (replacement)

PKZ0, PKE + 2 x DILM7	PKZM0-XM12RM 105192
PKZ0, PKE + 2 x DILM9	
PKZ0, PKE + 2 x DILM12	

Information relevant for export to North America



Product standards	UL 508; CSA-C22.2 No. 14; IEC60947-4-1; CE marking
UL File No.	E36332
UL CCN	NLRV
CSA File No.	165628
CSA Class No.	3211-05
NA Certification	UL Listed, CSA certified

For use with	Type Article no.	Std. pack	Notes
--------------	---------------------	-----------	-------

Top-hat rail adapter plates



PKZM0-XDM12 PKZM0-XRM12	PKZM0-XC45 283132	4 pcs.	Comprised of: 45 mm wide adapter plate
----------------------------	-----------------------------	--------	---



PKZM4 + DILM40 PKZM4 + DILM50 PKZM4 + DILM65	PKZM4-XC55/2 ¹⁾ 101054	4 pcs. 	Comprised of: 55 mm wide adapter plate
--	---	------------	---

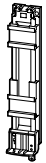

PKZM0, PKE	PKZM0-XC45-2 149147	2 pcs.	for DOL Starter consists of: 45 mm wide adapter plate
------------	-------------------------------	--------	--

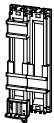

	PKZM0-XC90-2 149148		for reversing starters consists of: 45 mm wide adapter plates
--	-------------------------------	--	--

Soft starter



PKZM0, PKE + DS7...004N... PKZM0, PKE + DS7...007N... PKZM0, PKE + DS7...009N... PKZM0, PKE + DS7...012N...	PKZM0-XC45L 142529	1 pc.	Comprised of: 45 mm wide adapter plate
--	------------------------------	-------	---

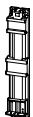

PKZM0, PKE + DS7...016N... PKZM0, PKE + DS7...024N... PKZM0, PKE + DS7...032N...	PKZM0-XC45L/2 142570	1 pc.	Comprised of: 45 mm wide adapter plate
--	--------------------------------	-------	---

Information relevant for export to North America











Product standards	UL 508; CSA-C22.2 No. 14; IEC60947-4-1; CE marking
UL File No.	E300273
UL CCN	NMTR
CSA File No.	232140
CSA Class No.	3211-37
NA Certification	UL recognized, CSA certified







Circuit breaker Number	Length mm	Pitch dimensions mm	Type Article no.	Std. pack	Notes
------------------------	-----------	---------------------	------------------	-----------	-------

Three-phase commoning links



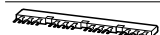

Protected against accidental contact, short-circuit proof, $U_n = 690\text{ V}$, $I_n = 63\text{ A}$
 Can be extended by rotating mounting
 For PKZM0-... or PKE without side mounted auxiliary contacts or voltage releases

	2	90	45	B3.0/2-PKZ0 063961	10 pcs.  	For parallel feeding of multiple motor-protective circuit breakers on terminals 1, 3, 5 1) for supply from below
	3	135	45	B3.0/3-PKZ0 232289		
	4	180	45	B3.0/4-PKZ0 063960		
	4	170	45	B3.0/4-PKZ0-U ¹⁾ 292389	5 pcs.	
	5	225	45	B3.0/5-PKZ0 232290	10 pcs.  	

Attached on the right, for motor-protective circuit breakers, with an auxiliary contact or trip-indicating auxiliary contact

	2	99	45 + 9	B3.1/2-PKZ0 044945	10 pcs.  	For parallel feeding of multiple motor-protective circuit breakers on terminals 1, 3, 5
	3	153	45 + 9	B3.1/3-PKZ0 044946		
	4	207	45 + 9	B3.1/4-PKZ0 044947		
	5	261	45 + 9	B3.1/5-PKZ0 044948		



For PKZM0-... or PKE attached with an auxiliary contact and a trip indicating signal on the right or attached on the left with a voltage release

	2	108	45 + 18	B3.2/2-PKZ0 063963	10 pcs.  	For parallel feeding of multiple motor-protective circuit breakers on terminals 1, 3, 5
	4	234	45 + 18	B3.2/4-PKZ0 063959		

Shroud for unused terminal

Protective against direct contact.
 For covering unused terminals on three-phase commoning link B3...-PKZ0



-	-	-		H-B3-PKZ0 032721	20 pcs.  
---	---	---	--	----------------------------	---







Information relevant for export to North America



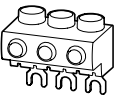

Product standard	UL 508; CSA-C22.2 No. 14; IEC60947-4-1; CE marking
UL File No.	E36332
UL CCN	NLRV
CSA File No.	98494
CSA Class No.	3211-06
NA Certification	UL Listed, CSA certified

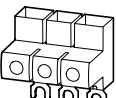
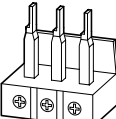
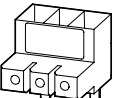
Extension terminals BK.../3-PKZ...

3

For use with	Type Article no.	Std. pack	Notes	Information relevant for export to North America  		
Extension terminal						
	PKZM0 PKE12 PKE32	BK25/3-PKZO 032720	5 pcs.  	Protected against accidental contact, for three-phase commoning link, $U_g = 690\text{ V}$, $I_u = 63\text{ A}$ for conductor cross-sections: 2.5 - 25 mm ² stranded 2.5 - 16 mm ² flexible with ferrules AWG 14 - 6, usable on terminals 1, 3, 5	Product standards UL File No. UL CNN CSA File No. CSA Class No. NA Certification	UL 508; CSA-C22.2 No. 14; IEC60947-4-1; CE marking E36332 NLRV 165628 3211-05 UL listed, CSA certified
	PKZM0 PKE12 PKE32	BK25/3-PKZO-E 262518		Protected against accidental contact, for three-phase commoning link, $U_g = 690\text{ V}$, $I_u = 60\text{ A}$ for conductor cross-sections: 2.5 - 25 mm ² stranded 2.5 - 16 mm ² flexible with ferrules AWG 14 - 6 For surface-mounting type-E starters.	Product standards UL File No. UL CNN CSA File No. CSA Class No. NA Certification Specially designed for NA Suitable for	UL 508; CSA-C22.2 No. 14; IEC60947-4-1; CE marking E36332 NLRV 98494 3211-06 UL listed, CSA certified ✓ PKZM0/PKE, line terminal required for type E/F applications
	PKE32/XTUCP-36 PKE32 + PKE-XTUCP-36 PKE32 + PKE-XTUACP-36	BK25/3-PKZO-U 292886	10 pcs.	Protected against accidental contact, for three-phase commoning link, $U_g = 690\text{ V}$, $I_u = 63\text{ A}$ for conductor cross-sections: 2.5 - 25 mm ² stranded 2.5 - 16 mm ² flexible with ferrules AWG 14 - 6, usable on terminals 2, 4, 6 Incoming unit from bottom	–	–
	PKZM4 PKE65	BK50/3-PKZ4-E 272165	1 pc.  	Cannot be combined with three-phase commoning link B3...PKZ4 $I_u = 120\text{ A}$ For surface-mounting type-E starters	Product standards UL File No. UL CNN CSA File No. CSA Class No. NA Certification Specially designed for NA Suitable for	UL 508; CSA-C22.2 No. 14; IEC60947-4-1; CE marking E36332 NLRV 165628 3211-06 UL listed, CSA certified ✓ PKZM4/PKE, line terminal required for type E/F applications







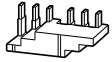

Three-phase commoning links B3.../...-PKZ4

Circuit breaker	Length	Pitch dimensions	Type Article no.	Std. pack	Information relevant for export to North America
Number	mm	mm			 

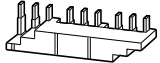
Three-phase commoning links

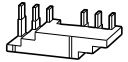
Protected against accidental contact, short-circuit proof, $U_e = 690\text{ V}$, $I_n = 128\text{ A}$

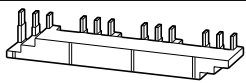

For PKZM4 without laterally attached auxiliary contact or shunt release

	2	110	55	B3.0/2-PKZ4 220220	1 pc.  	Product standards	UL 508; CSA-C22.2 No. 14; IEC60947-4-1; CE marking
	3	165		B3.0/3-PKZ4 220221		UL File No.	E36332
	4	220		B3.0/4-PKZ4 220222		UL CCN	NLRV
						CSA File No.	165628
						CSA Class No.	3211-06
						NA Certification	UL Listed, CSA certified
For PKZM4 each with an auxiliary contact or trip-indicating auxiliary contact fitted on the right							
	2	119	55 + 9	B3.1/2-PKZ4 220223	1 pc.  		
	3	183		B3.1/3-PKZ4 220224			
	4	247		B3.1/4-PKZ4 220225			

Shroud for unused terminal

Protective against direct contact.

For covering unused terminals on three-phase commoning link B3...-PKZ4

	-	-	-	H-B3-PKZ4 220228	10 pcs.  	Product standards	UL 508; CSA-C22.2 No. 14; IEC60947-4-1; CE marking
						UL File No.	E36332
						UL CCN	NLRV
						CSA File No.	165628
						CSA Class No.	3211-06
						NA Certification	UL Listed, CSA certified

Voltage release A-PKZ0, U-PKZ0, actuating voltages

3

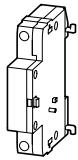

Operating voltage	Type Article no.	Std. pack	Type Article no.	Std. pack	Notes
-------------------	---------------------	-----------	---------------------	-----------	-------

Shunt releases, undervoltage releases

AC	Shunt release		Undervoltage release		
Standard voltage					
24 V 50 Hz	A-PKZ0(24V50HZ) 073181	2 pcs. 	U-PKZ0(24V50HZ) 073129	2 pcs. 	
110 V 50 Hz	A-PKZ0(110V50HZ) 073184		U-PKZ0(110V50HZ) 073132		
220 V 50 Hz	A-PKZ0(220V50HZ) 073186		U-PKZ0(220V50HZ) 073134		
240 V 50 Hz	A-PKZ0(240V50HZ) 073188		U-PKZ0(240V50HZ) 073136		
380 V 50 Hz	A-PKZ0(380V50HZ) 073189		U-PKZ0(380V50HZ) 073137		
400 V 50 Hz	A-PKZ0(400V50HZ) 073190		U-PKZ0(400V50HZ) 073138		
415 V 50 Hz	A-PKZ0(415V50HZ) 073191		U-PKZ0(415V50HZ) 073139		
24 V 60 Hz	A-PKZ0(24V60HZ) 172269		U-PKZ0(24V60HZ) 219219		
120 V 60 Hz	A-PKZ0(120V60HZ) 073195		U-PKZ0(120V60HZ) 073143		
208 V 60 Hz	A-PKZ0(208V60HZ) 073197		U-PKZ0(208V60HZ) 073145		
240 V 60 Hz	A-PKZ0(240V60HZ) 073198		U-PKZ0(240V60HZ) 073146		
440 V 60 Hz	A-PKZ0(440V60HZ) 082164		U-PKZ0(440V60HZ) 082161		
480 V 60 Hz	A-PKZ0(480V60HZ) 073199		U-PKZ0(480V60HZ) 073147		
600 V 60 Hz	–		U-PKZ0(600V60HZ) 158257		

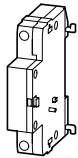

Non-standard voltages apart from the previously mentioned standard voltages					
...V 50 Hz (24 - 500 V)	A-PKZ0(*V50HZ) 982165	2 pcs. 	U-PKZ0(*V50HZ) 982162	2 pcs. 	For non-standard voltages, the required actuating voltage from the specified range (...-...V) must be indicated in the * for the type. Minimum order quantity: 10 pcs.
...V 60 Hz (24 - 600 V)	A-PKZ0(*V60HZ) 982166		U-PKZ0(*V60HZ) 982163		

DC

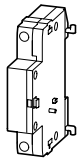

Standard voltage					
60 V DC	A-PKZ0(60VDC) 073202	2 pcs. 	–		
110 V DC	A-PKZ0(110VDC) 073203	2 pcs. 	–		

Notes

Information relevant for export to North America



Product standards	UL 508; CSA-C22.2 No. 14; IEC60947-4-1; CE marking
UL File No.	E36332
UL CCN	NLRV
CSA File No.	165628
CSA Class No.	3211-05
NA Certification	UL-listed, CSA-certified

Engineering

PKZM0(1) and PKZM4 in 1- and 2-pole switching with DC and AC operation



PKZM0(1) and PKZM4 in 2-pole connection with CL-PKZ0

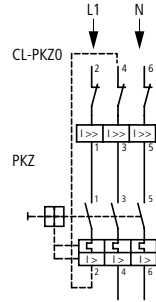

3

Protection of PVC insulated cables against thermal overload with short-circuits

The table specifies which minimum conductor cross-sections are protected by motor-protective circuit breakers up to their conditional rated short-circuit current I_q .

Min. cross-section protected 380 - 415 V, 50 Hz, Cu mm ²					Device Type
4	2.5	1.5	1	0.75	
					PKZM0-0.16
					...
					PKZM0-6.3
					PKZM0-10
					PKZM0-12
					PKZM0-16
					PKZM0-20
					PKZM0-25
					PKZM0-32
					PKZM4-16
					PKZM4-25
					PKZM4-32
					PKZM4-40
					PKZM4-50
					PKZM4-58
					PKZM4-63

Protected minimum cross-section in mm ²								Trip block Type
16	10	6	4	2.5	1.5	0.75	0.5	
								PKE-XTU(A)-1.2
								PKE-XTU(A)-4
								PKE-XTU(A)-12
								PKE-XTU(A)-32
								PKE-XTUCP(A)-36
								PKE-XTUW(A)-32
								PKE-XTU(A)-65
PKE-XTUWCP(A)-36								
PKE-XTUCP(A)-65								

Tripping characteristics of PKZM0-...(T)(not for PKM0-...), PKZM01, PKZM4 motor-protective circuit breakers

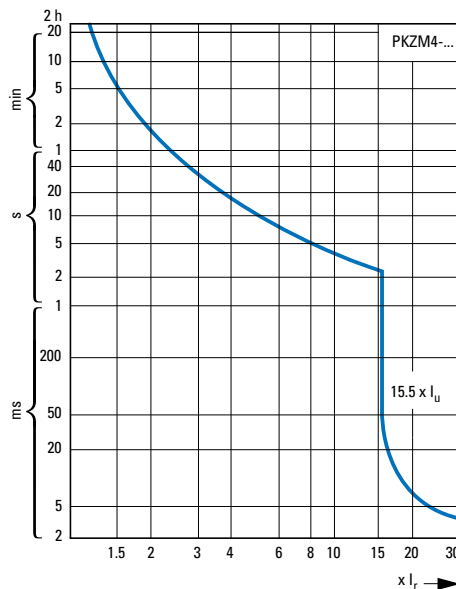
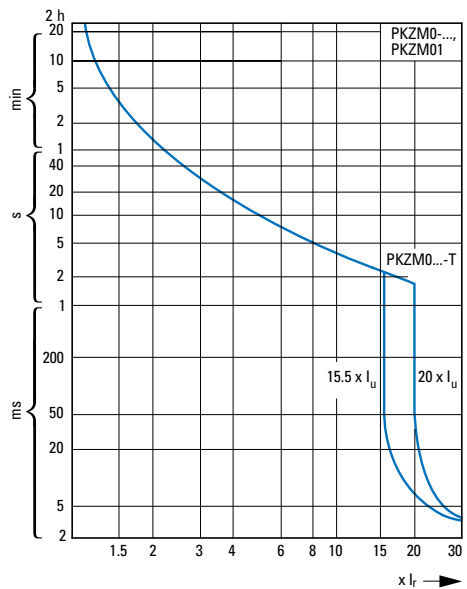

Characteristic curves

3

Tripping characteristic curves, wide-range circuit breaker PKE

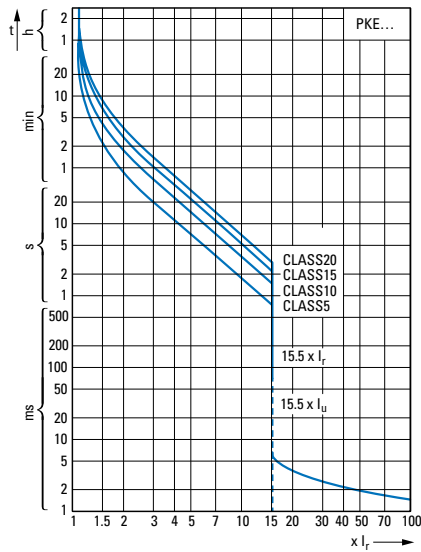

Tripping characteristics of system circuit breaker PKE.../XTU(W)CP...

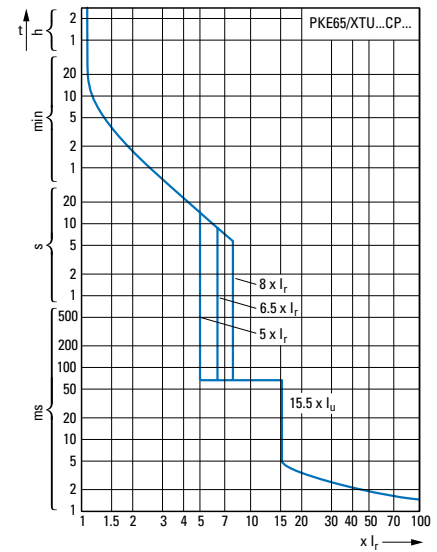
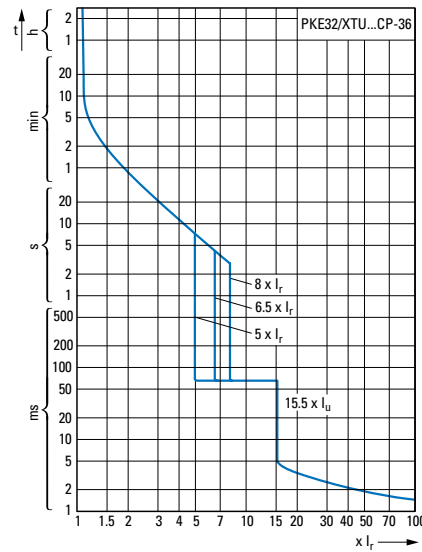

Let-through characteristics, motor-protective circuit breaker, transformer-protective circuit breaker, circuit breaker for starter combinations

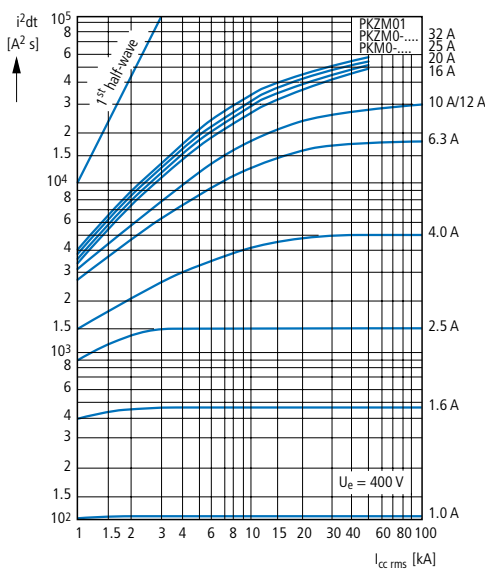
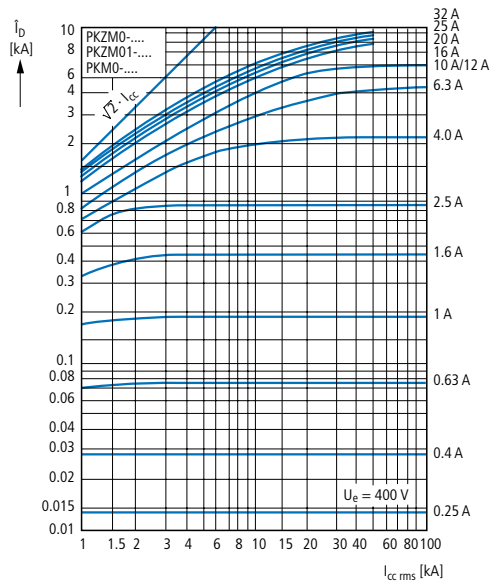

Motor-protective circuit breaker let-through characteristics

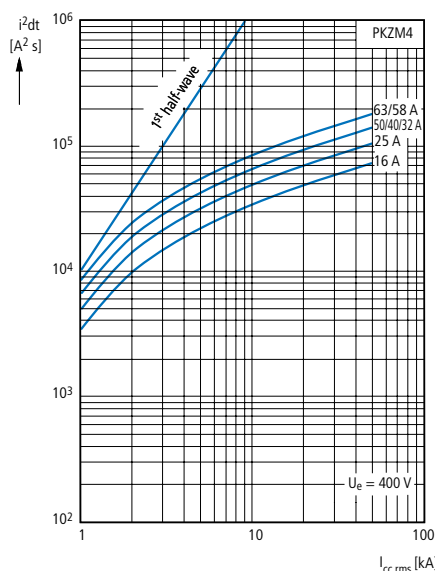
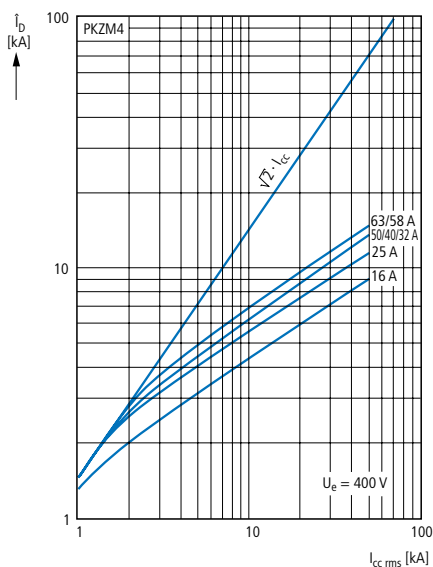

Let-through current

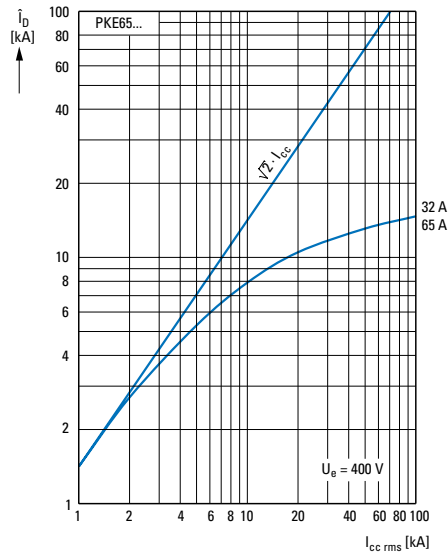
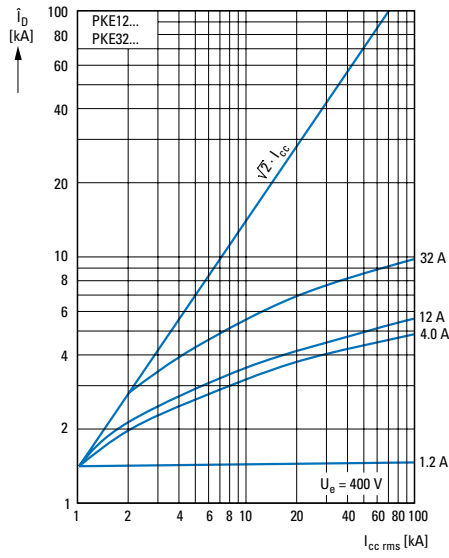

Let-through energy

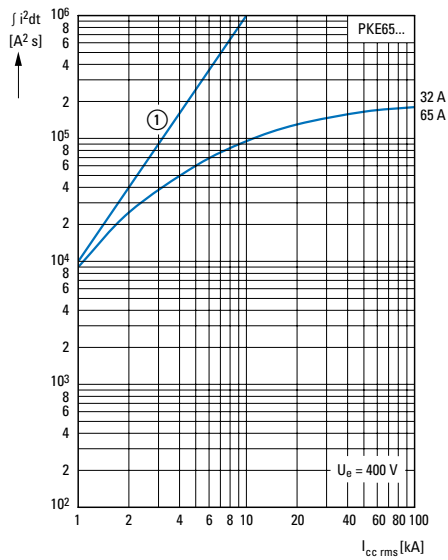
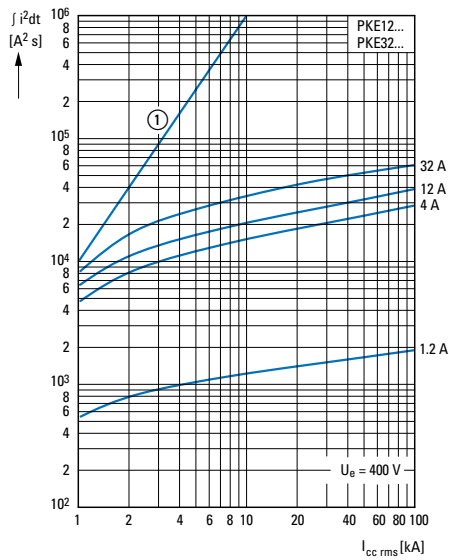

① Half-cycle

Switching capacity

3

Circuit breaker switching capacity from serial no. 04

Rated uninterrupted current I_u

Rated conditional short-circuit current I_q IEC/EN 60947-4-1

Rated ultimate short-circuit breaking capacity I_{cu}

Rated service short-circuit breaking capacity I_{cs} IEC/EN 60947-2

I_u A	230 V				400 V				440 V				500 V				690 V				
	I_q kA	I_{cu} kA	I_{cs} kA	A ¹⁾	I_q kA	I_{cu} kA	I_{cs} kA	A ¹⁾	I_q kA	I_{cu} kA	I_{cs} kA	A ¹⁾	I_q kA	I_{cu} kA	I_{cs} kA	A ¹⁾	I_q kA	I_{cu} kA	I_{cs} kA	A ¹⁾	
PKZMO, PKZMO...-T, PKMO with type "1" and "2" coordination																					
0.16 – 1	150	150	150	N	150	150	150	N	150	150	150	N	150	150	150	N	150	150	150	N	
1.6	150	150	150	N	150	150	150	N	150	150	150	N	150	150	150	N	150	150	150	N	
2.5	150	150	150	N	150	150	150	N	150	150	150	N	150	150	150	N	5	5	5	50	
4	150	150	150	N	150	150	150	N	150	150	150	N	150	150	150	N	3	3	3	50	
6.3	150	150	150	N	150	150	150	N	150	150	150	N	42	42	42	50	3	3	2	50	
10	150	150	150	N	150	150	150	N	50	50	50	50	42	42	11	50	3	3	2	50	
12	50	50	38	50	50	50	38	50	50	15	12	50	15	15	4	50	3	3	2	50	
16	50	50	38	50	50	50	38	50	50	15	12	50	15	15	4	50	3	3	2	50	
20	50	50	38	50	50	50	38	50	50	10	3	50	10	3	3	50	3	3	1	50	
25	50	50	38	50	50	50	38	50	50	10	3	50	10	3	3	50	3	3	1	50	
32	50	40	10	50	50	40	10	50	50	10	3	50	10	3	3	50	3	3	1	50	
PKZMO (PKZMO...-T, PKMO) + CL-PKZO																					
0.16 – 1				N				N				N				N				20	N
1.6				N				N				N				N				20	N
2.5				N				N				N				N	20	20	20	N	
4				N				N				N				N	20	20	20	N	
6.3				N				N				N				50	N	20	20	20	N
10				N				N				N				20	N	20	20	20	N
12				N				N				N				20	N	5	5	2.5	N
16				N				N				N				20	N	5	5	2.5	N
20				N				N				N	10	10	10	N	5	5	2.5	N	
25				N				N				N	10	10	10	N	5	5	2.5	N	
32				N				N				N	10	10	10	N	5	5	2.5	N	
PKZMO (PKZMO...-T, PKMO) + 2 CL-PKZO																					
0.16 – 1				N				N				N				N				20	N
1.6				N				N				N				N				20	N
2.5				N				N				N				N	40	40	20	N	
4				N				N				N				N	40	40	20	N	
6.3				N				N				N				50	N	20	20	20	N
10				N				N				N				40	N	20	20	20	N
12				N				N				N				40	N	10	10	2.5	N
16				N				N				N				40	N	10	10	2.5	N
20				N				N				N	20	20	20	N	10	10	2.5	N	
25				N				N				N	20	20	20	N	10	10	2.5	N	
32				N				N				N	20	20	20	N	10	10	2.5	N	

Notes

■ – No upstream protective element required, as it is the auto-protected range (100/150 kA)

N – Not required

¹⁾ Necessary back-up fuse when the short-circuit current exceeds the rated conditional short-circuit current of the devices ($I_{cc} > I_q$).

Circuit breaker switching capacity

Rated uninterrupted current I_u

Rated conditional short-circuit current I_q IEC/EN 60947-4-1

Rated ultimate short-circuit breaking capacity I_{cu}

Rated service short-circuit breaking capacity I_{cs} IEC/EN 60947-2

I_u A	230 V				400 V				440 V				500 V				690 V			
	I_q kA	I_{cu} kA	I_{cs} kA	A ¹⁾	I_q kA	I_{cu} kA	I_{cs} kA	A ¹⁾	I_q kA	I_{cu} kA	I_{cs} kA	A ¹⁾	I_q kA	I_{cu} kA	I_{cs} kA	A ¹⁾	I_q kA	I_{cu} kA	I_{cs} kA	A ¹⁾

PKZM01 with type "1" and "2" coordination

0.16 - 1	50	50	50	50	50	50	50	50	50	50	50	50	50	50	50	50	50	50	50	50
1.6	50	50	50	50	50	50	50	50	50	50	50	50	50	50	50	50	50	50	50	50
2.5	50	50	50	50	50	50	50	50	50	50	50	50	50	50	50	50	50	50	50	50
4	50	50	50	50	50	50	50	50	50	50	50	50	50	50	50	50	50	50	50	50
6.3	50	50	50	50	50	50	50	50	50	50	50	50	50	50	50	50	50	50	50	50
10	50	50	50	50	50	50	50	50	42	42	10	50	50	50	50	50	50	50	50	50
12	50	50	10	50	50	50	10	50	15	15	10	50	50	50	50	50	50	50	50	50
16	50	50	10	50	50	50	10	50	15	15	10	50	50	50	50	50	50	50	50	50
20	50	50	10	50	50	50	10	50	10	10	3	50	50	50	50	50	50	50	50	50
25	50	50	10	50	50	50	10	50	10	10	3	50	50	50	50	50	50	50	50	50

PKZM4 with type "1" and "2" coordination

16	150	100	25	N	150	100	25	N	45	45	12	100	15	15	4	100	8	8	2.5	100
25	150	100	25	N	150	100	25	N	45	45	12	100	15	15	4	100	8	8	2.5	100
32	50	50	25	100	50	50	25	100	45	45	12	100	15	15	4	100	5	5	2.5	100
40	50	50	25	100	50	50	25	100	45	45	12	100	15	15	4	100	5	5	2.5	100
50	50	50	25	100	50	50	25	100	45	45	12	100	15	15	4	100	5	5	2.5	100
58	50	50	25	160	50	50	25	160	45	45	12	160	15	15	4	160	5	5	2.5	160
63	50	50	25	160	50	50	25	160	45	45	12	160	15	15	4	160	5	5	2.5	160

Notes

— No upstream protective element required, as it is the auto-protected range (100/150 kA)

N – Not required

¹⁾ Max. Fuse (A gG/gL) for enhancing the switching capacity of the motor-protective circuit breaker to 100 kA

Motor-protective circuit breaker internal resistances

	Impedance	Current heat losses (3-pole at operating temperature)	Rated uninterrupted current I_u
	Ω	W	A
PKZM0-0.16	68	5.39	0.16
PKZM0-0.25	26.5	5.15	0.25
PKZM0-0.4	10.5	5.22	0.4
PKZM0-0.63	4.2	5.16	0.63
PKZM0-1	1.7	5.33	1
PKZM0-1.6	0.7	5.36	1.6
PKZM0-2.5	0.27	5.16	2.5
PKZM0-4	0.11	5.33	4
PKZM0-6.3	0.046	5.68	6.3
PKZM0-10	0.021	6.48	10
PKZM0-12	0.015	6.64	12
PKZM0-16	0.008	6.43	16
PKZM0-20	0.005	5.82	20
PKZM0-25	0.004	7.04	25
PKZM0-32	0.003	9.56	32
PKZM4-16	0.029	14.1	16
PKZM4-25	0.012	14.7	25
PKZM4-32	0.007	18	32
PKZM4-40	0.005	20.7	40
PKZM4-50	0.003	24.6	50
PKZM4-58	0.002	28.2	58
PKZM4-63	0.002	31.5	65

Switching capacity of motor-protective circuit breakers, motor-starter combinationsRated conditional short-circuit current I_q IEC/EN 60947-4-1Rated ultimate short-circuit breaking capacity I_{cu} IEC/EN 60947-2Rated service short-circuit breaking capacity I_{cs} IEC/EN 60947-2

	230/400 V			415 V			440 V			500 V			525 V			690 V		
	I_q	I_{cu}	I_{cs}	I_q	I_{cu}	I_{cs}	I_q	I_{cu}	I_{cs}	I_q	I_{cu}	I_{cs}	I_q	I_{cu}	I_{cs}	I_q	I_{cu}	I_{cs}
	kA	kA	kA	kA	kA	kA	kA	kA	kA	kA	kA	kA	kA	kA	kA	kA	kA	kA
PKE... with type "1" and "2" coordination																		
PKE12/XTU(A)-1.2	100	N	N	50	N	N	15	N	N	10	N	N	10	N	N	3	N	N
PKE12/XTU(A)-4	100	N	N	50	N	N	50	N	N	10	N	N	10	N	N	3	N	N
PKE12/XTU(A)-12	100	N	N	50	N	N	20	N	N	20	N	N	10	N	N	3	N	N
PKE32/XTU(A)-32	100	N	N	50	N	N	25	N	N	6	N	N	3	N	N	3	N	N
PKE32/XTUCP(A)-36	N	50	12.5	N	–	–	N	–	–	N	–	–	N	–	–	N	–	–
PKE12/XTU(A)-12 + 80A gG/gL	100	N	N	100	N	N	100	N	N	100	N	N	100	N	N	100	N	N
PKE32/XTU(A)-32 + 80A gG/gL	100	N	N	100	N	N	100	N	N	100	N	N	100	N	N	100	N	N
PKE65/XTUW(A)-32	80	N	N	80	N	N	45	N	N	15	N	N	10	N	N	5	N	N
PKE65/XTU(A)-65	80	N	N	80	N	N	45	N	N	15	N	N	10	N	N	5	N	N
PKE65/XTUCP(A)-65	N	50	13	N	45	12	N	45	12	N	15	4	N	5	2	N	5	2
PKE65/XTUCP(A)-36	N	50	13	N	–	–	N	–	–	N	–	–	N	–	–	N	–	–
Motor-starter combinations MSC-DE(A)-... with type "1" coordination																		
MSC-DE(A)-1.2-M7	100	N	N	50	N	N	15	N	N	10	N	N	–	N	N	–	N	N
MSC-DE(A)-4-M7	100	N	N	50	N	N	50	N	N	50	N	N	–	N	N	–	N	N
MSC-DE(A)-12-M12	100	N	N	50	N	N	50	N	N	20	N	N	–	N	N	–	N	N
MSC-DE(A)-12-M17	100	N	N	65	N	N	65	N	N	50	N	N	50	N	N	3	N	N
MSC-DE(A)-32-M32	100	N	N	100	N	N	50	N	N	50	N	N	5	N	N	5	N	N
Motor-starter combinations MSC-DE-... with type "2" coordination																		
MSC-D(M)E-1.2-M17	100	N	N	65	N	N	65	N	N	10	N	N	3	N	N	–	N	N
MSC-D(M)E-4-M17	100	N	N	65	N	N	65	N	N	50	N	N	3	N	N	–	N	N
MSC-D(M)E-12-M17	100	N	N	65	N	N	65	N	N	50	N	N	50	N	N	–	N	N
MSC-D(M)E-32-M32	100	N	N	100	N	N	65	N	N	50	N	N	20	N	N	5	N	N
MSC-DE-36-M38	25	N	N	10	N	N	10	N	N	10	N	N	N	N	N	N	N	N
PKE./XTU...+DILM...+CL-PKZ0 with type "2" coordination																		
PKE12/XTU-1.2 + DILM17 + CL-PKZ0	100	N	N	100	N	N	100	N	N	100	N	N	–	N	N	–	N	N
PKE12/XTU-4 + DILM17 + CL-PKZ0	100	N	N	100	N	N	100	N	N	100	N	N	50	N	N	–	N	N
PKE12/XTU-12 + DILM17 + CL-PKZ0	100	N	N	100	N	N	100	N	N	100	N	N	50	N	N	–	N	N
PKE32/XTU-32 + DILM32 + CL-PKZ0	100	N	N	100	N	N	100	N	N	100	N	N	50	N	N	25	N	N
PKE65/XTU(A)-65+DILM...(+CL) with type "2" coordination																		
PKE65/XTU(A)-65 + DILM40	80	N	N	50	N	N	50	N	N	50	N	N	–	N	N	10	N	N
PKE65/XTU(A)-65 + DILM50	80	N	N	50	N	N	50	N	N	50	N	N	–	N	N	10	N	N
PKE65/XTU(A)-65 + DILM65	80	N	N	50	N	N	50	N	N	50	N	N	–	N	N	10	N	N
PKE65/XTU(A)-65 + DILM40 + CL	100	N	N	100	N	N	85	N	N	85	N	N	85	N	N	–	N	N

Notes N – Not required

Technical data

3

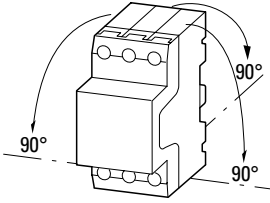
		PKZM01...	PKZM0-... ¹⁾		
General					
Standards		IEC/EN 60947, VDE 0660, UL, CSA IEC/EN 60947, VDE 0660 (PKZM01...-G)			
Climatic proofing		Humid warmth, constant as per IEC 60068-2-78 Damp heat, cyclic, to IEC 60068-2-30			
Ambient temperature	Storage	°C	-40 - 80		
	Open	°C	-25 - 55		
	Enclosed	°C	-25 - 40		
Mounting position					
Direction of incoming supply		Any	Any		
Protection rating	Device/enclosure		IP20/IP40 (PKZM01...-G)	IP20	
	Terminals		IP00	IP00	
Busbar tag shroud when actuated from front (EN 50274)		Finger- and back-of-hand proof			
Mechanical shock resistance half-sinusoidal shock 10 ms to IEC 60068-2-27	g	25	25		
Altitude	m	max. 2000	max. 2000		
Terminal capacities					
Main conductors					
Screw terminals					
	Solid	mm ²	1 x (1 - 6) 2 x (1 - 6)	1 x (1 - 6) 2 x (1 - 6)	
	flexible with ferrules to DIN 46228	mm ²	1 x (1 - 6) 2 x (1 - 6)	1 x (1 - 6) 2 x (1 - 6)	
	Solid or stranded	AWG	18 - 10	18 - 10	
	Stripping length	mm	10	10	
Spring-loaded terminals					
	Solid	mm ²	–	1 x (0.75 - 2.5) 2 x (0.75 - 2.5)	
	flexible with ferrules to DIN 46228	mm ²	–	1 x (0.75 - 2.5) 2 x (0.75 - 2.5)	
	Solid or stranded	AWG	–	18 - 14	
	Stripping length	mm	–	10	
Control circuit cable					
Screw terminals					
	Solid	mm ²	–	...NHI... 1 x (0.75 - 2.5) 2 x (0.75 - 2.5)	...NHI-E... 1 x (0.75 - 1.5) 2 x (0.75 - 1)
	flexible with ferrule	mm ²	–	1 x (0.75 - 2.5) 2 x (0.75 - 2.5)	1 x (0.75 - 1.5) 2 x (1 - 1.5)
	Solid or stranded	AWG	–	18 - 14	18 - 16
Spring-loaded terminals					
	Solid	mm ²	–	–	1 x (0.75 - 2.5) 2 x (0.75 - 2.5)
	flexible with ferrule	mm ²	–	–	1 x (0.75 - 1.5) 2 x (0.75 - 1.5)
	Solid or stranded	AWG	–	–	14
Terminal screw tightening torque					
	Main conductors	Nm	1.7	1.7	
	Control circuit cable	Nm	–	1	1.2

Notes

¹⁾ Tested according to IEC/EN 60947-1 (disconnecter characteristics) and IEC/EN 60947-2

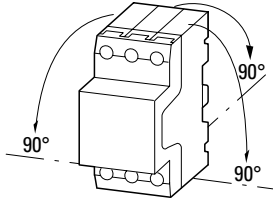
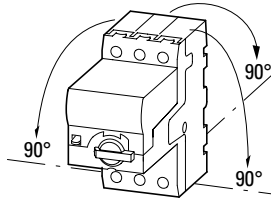
PKM0-...	PKZM0-...-T	PKZM4	PKZM4...-CB...	PKE12..., PKE32...	PKE65...
IEC/EN 60947, VDE 0660		IEC/EN 60947, VDE 0660, UL, CSA		IEC/EN 60947, VDE 0660, UL, CSA IEC/EN 60947, VDE 0660 (PKE.../XTU...CP..., PKE-XTU-36)	
Humid warmth, constant as per IEC 60068-2-78 Damp heat, cyclic, to IEC 60068-2-30					
-40 - 80	-40 - 80	-40 - 80	-40 - 80	-40 - 80	-40 - 80
-25 - 55	-25 - 55	-25 - 55	-25 - 55	-25 - 55	-25 - 55
-25 - 40	-25 - 40	-25 - 40	-25 - 40	-25 - 40 (-20 - 40 for PKE-XTUA...)	-25 - 40 (-20 - 40 for PKE-XTUA...)
					
Any	Any	Any		Any	Any
IP20	IP20	IP20	IP20	IP20	IP20
IP00	IP00	IP00	IP2X	IP00	IP00
Finger- and back-of-hand proof					
25	25	15		25	15
max. 2000	max. 2000	max. 2000		max. 2000	max. 2000
1 x (1 - 6)	1 x (1 - 6)	1 x (0.75 - 16)	1 x (0.75 - 16)	1 x (1 - 6)	1 x (0.75 - 16)
2 x (1 - 6)	2 x (1 - 6)	2 x (0.75 - 16)	2 x (0.75 - 16)	2 x (1 - 6)	2 x (0.75 - 16)
1 x (1 - 6)	1 x (1 - 6)	1 x (0.75 - 35)	1 x (0.75 - 16)	1 x (1 - 6)	1 x (0.75 - 35)
2 x (1 - 6)	2 x (1 - 6)	2 x (0.75 - 25)	2 x (0.75 - 16)	2 x (1 - 6)	2 x (0.75 - 25)
18 - 10	18 - 10	14 - 2	14 - 8	14 - 10	14 - 2
10	10	14	14	10	14
-	-	-	-	-	-
-	-	-	-	-	-
-	-	-	-	-	-
-	-	-	-	-	-
-	-	-	-	-	-
-	-	-	-	-	-
-	-	-	-	-	-
-	-	-	-	-	-
-	-	-	-	-	-
-	-	-	-	-	-
-	-	-	-	-	-
-	-	-	-	-	-
-	-	-	-	-	-
-	-	-	-	-	-
1.7	1.7	3.3	3.3	1.7	3.3
-	-	-	-	-	-

			PKZM01...	PKZM0-... ¹⁾
Main circuits				
Rated impulse withstand voltage	U_{imp}	V AC	6000	6000
Overvoltage category/degree of pollution			III/3	III/3
Rated operating voltage	U_e	V AC	690	690
Rated uninterrupted current = rated operational current	$I_u = I_e$	A	16 or set current of the overcurrent release	32 or set current of the overcurrent release
Rated frequency	f	Hz	40 - 60	40 - 60
Current heat loss (3-pole at operating temperature) (Device-dependent → data sheet in online catalog)		W	5.15 – 7.04	5.15 – 9.56
Lifespan, mechanical	Operations	x 10 ⁶	0.05	0.1
Lifespan, electrical (AC-3 at 400 V)	Operations	x 10 ⁶	0.05	0.1
Maximum operating frequency	Operations/h	ops./h	25	40
Short-circuit rating				
AC			→ page 3/45	→ page 3/44
DC		kA	60	60 (up to PKZM0-16) 40 (PKZM0-20 to PKZM0-32)
Note			up to 250 V	up to 250 V
Motor switching capacity				
AC-3 (up to 690 V)		A	25	32
DC-5 (up to 250V)		A	25 (3 contacts in series)	25 (3 contacts in series)
Triggers				
Temperature compensation				
	to IEC/EN 60947, VDE 0660	°C	5	5 – 40
	Operating range	°C	25	25 - 55
Temperature compensation residual error for T > 40°			≤ 0.25%/K	≤ 0.25%/K
Overload release setting range			0.6 - 1 x I _u	0.6 - 1 x I _u
short-circuit release			Basic device, fixed: 15.5 x I _u	Basic device, fixed: 15.5 x I _u
Short-circuit release tolerance			± 20%	± 20%
Phase-failure sensitivity			IEC/EN 60947-4-1, VDE 0660 part 102	IEC/EN 60947-4-1, VDE 0660 part 102

Notes¹⁾ Tested according to IEC/EN 60947-1 (disconnecter characteristics) and IEC/EN 60947-2

PKM0-...	PKZM0-...-T	PKZM4	PKZM4...-CB...	PKE12..., PKE32...	PKE65...
6000	6000	6000		6000	6000
III/3	III/3	III/3		III/3	III/3
690	690	690		690	690
32 or set current of the overcurrent release	25 or set current of the overcurrent release	16 - 65 open 16 - 63 enclosed Depending on device, → data sheet in online catalog		12 A or set current of the overload release 32 A or set current of the overload release	65 A or set current of the overload release
40 - 60	40 - 60	40 - 60		40 - 60	40 - 60
6	6	14.1 - 31.5		6 (with PKE-XTU(A)-32) 3.5 (with PKE-XTU(A)-12) 0.5 (with PKE-XTU(A)-4) 0.4 (with PKE-XTU(A)-1.2)	22 (with PKE65-XTU(A)-65) 6 (with PKE-XTUW(A)-32)
0.1	0.1	0.03		0.05	0.05
0.1	0.1	0.03		0.05	0.05
40	40	40		60	60
→ page 3/44	→ page 3/44	→ page 3/45		→ page 3/46	→ page 3/46
60 (to PKM0-16) 40 (PKM0-20 to PKM0-32)	60 (up to PKZM0-16) 40 (PKZM0-20 to PKZM0-32)	60		-	-
		up to 250 V			
32	25	65		12 32	65
25 (3 contacts in series)	25 (3 contacts in series)	63 (3 contacts in series)		-	-
5 - 40	5 - 40	5		5	5
25 - 55	25 - 55	25		25	25
≤ 0.25%/K	≤ 0.25%/K	≤ 0.25%/K		-	-
-	0.6 - 1 x I _u	0.6 - 1 x I _u		0.25 - 1 x I _u	0.25 - 1 x I _u 0.42 - 1 x I _u (with PKE-XTU(A)CP-65)
Basic device, fixed: 15.5 x I _u	Basic device, fixed: 15.5 x I _u	Basic device, fixed: 15.5 x I _u		Basic device, fixed: 15.5 x I _u Trip block: fixed: 15.5 x I _r adjustable: 5 - 8 x I _r delayed approx. 60 ms	Basic device, fixed: 15.5 x I _u Trip block: fixed: 15.5 x I _r adjustable: 5 - 8 x I _r delayed approx. 60 ms
± 20%	± 20%	± 20%		± 20%	± 20%
-	IEC/EN 60947-4-1, VDE 0660 part 102	IEC/EN 60947-4-1, VDE 0660 part 102		IEC/EN 60947-4-1, VDE 0660 part 102	IEC/EN 60947-4-1, VDE 0660 part 102 No (with PKE-XTU(A)CP-...)

Rating data for approved types

3

		PKZM01-...		PKZM0-...		PKZM4-...		PKE12/... PKE32/...		PKE65/...
Rating data for approved types										
Switching capacity										
Maximum motor rating										
3-phase										
	Type		Type		Type		Type		Type	
200 V, 208 V	HP	...0.16 - 1.6 → Special note	...0.16 - 1.6 → Special note	...16	3	...XTU-1.2	–	...XTUW-32	7.5	
		...2.5 0.5	...2.5 0.5	...25	5	...XTU-4	0.75	...XTU-65	15	
		...4 0.75	...4 0.75	...32	7.5	...XTU-12	3			
		...6.3 1	...6.3 1	...40	10	...XTU-32	5			
		...10 - 16 3	...10 - 16 3	...50 - 63	–					
		...20 5	...20 5							
		...25 –	...25 –							
			...32 7.5							
230 V/240 V	HP	...0.16 - 1.6 → Special note	...0.16 - 1.6 → Special note	...16	5	...XTU-1.2	–	...XTUW-32	7.5	
		...2.5 0.5	...2.5 0.5	...25	7.5	...XTU-4	0.75	...XTU-65	15	
		...4 0.75	...4 0.75	...32	10	...XTU-12	3			
		...6.3 1.5	...6.3 1.5	...40	–	...XTU-32	7.5			
		...10 - 12 3	...10 - 12 3	...50	15					
		...16 - 20 5	...16 5	...58 - 63	–					
		...25 7.5	...20 –							
			...25 7.5							
			...32 10							
460 V, 480 V	HP	...0.16 - 1 → Special note	...0.16 - 1 → Special note	...16	10	...XTU-1.2	0.5	...XTUW-32	20	
		...1.6 0.75	...1.6 0.75	...25	15	...XTU-4	2	...XTU-65	40	
		...2.5 1	...2.5 1	...32	20	...XTU-12	7.5			
		...4 2	...4 2	...40 - 50	30	...XTU-32	15			
		...6.3 3	...6.3 3	...58 - 63	40					
		...10 - 12 7.5	...10 - 12 7.5							
		...16 10	...16 10							
		...20 –	...20 –							
		...25 15	...25 15							
			...32 20							
575 V, 600 V	HP	...0.16 - 1 → Special note	...0.16 - 1 → Special note	...16	10	...XTU-1.2	0.5	...XTUW-32	25	
		...1.6 0.75	...1.6 0.75	...25	20	...XTU-4	3	...XTU-65	40	
		...2.5 1.5	...2.5 1.5	...32 - 40	30	...XTU-12	10			
		...4 3	...4 3	...50	40	...XTU-32	20			
		...6.3 5	...6.3 5	...58 - 63	50					
		...10 - 16 10	...10 - 16 10							
		...20 15	...20 15							
		...25 20	...25 20							
			...32 25							
1-phase										
	Type		Type		Type		Type		Type	
115 V, 120 V	HP	...0.16 - 2.5 –	...0.16 - 2.5 –	...16	1	...XTU-1.2	–	...XTUW-32	2	
		...4 0.125	...4 0.125	...25	2	...XTU-4	0.125	...XTU-65	3	
		...6.3 0.25	...6.3 0.25	...32	–	...XTU-12	1			
		...10 - 12 0.5	...10 - 12 0.5	...40	3	...XTU-32	1.5			
		...16 1	...16 1	...50 - 63	–					
		...20 1.5	...20 1.5							
		...25 2	...25 2							
			...32 –							
230 V/240 V	HP	0.16 - 1 –	0.16 - 1 –	...16	2	...XTU-1.2	–	...XTUW-32	3	
		1.6 0.1	1.6 0.1	...25	3	...XTU-4	0.33	...XTU-65	10	
		2.5 0.17	2.5 0.17	...32	5	...XTU-12	1.5			
		4 0.33	4 0.33	...40	7.5	...XTU-32	3			
		6.3 0.5	6.3 0.5	...50	–					
		10 1.5	10 1.5	...58	10					
		12 - 16 2	12 - 16 2	...63	–					
		20 3	20 3							
General use	A	25 –	25 –			...XTU-1.2	–	...XTUW-32	32	
			32 5			...XTU-4	–	...XTU-65	58	
						...XTU-12	12			
						...XTU-32	32			

Notes Calculate motor output in this range according to the rated operational current. Stated values according to NEC Table 430-150

	PKZM01-...	PKZM0-...	PKZM4-...	PKE12/... PKE32/...	PKE65/...
Rating data for approved types					
Short Circuit Current Rating (UL489, CSA 22.2 No. 5.09)			Type		Type
480 Y / 277 V	kA	–	–	-CB 65	–
600 Y / 347 V	kA	–	–	-CB 22	–
Short Circuit Current Rating, Type E			Type		Type
240 V	kA	–	...0.16 - 12 65	...16 - 40 65	–
		–	...16 42	...50 - 63 50	AK/XTUW-32-SP 65
		–	...20 - 32 18	...50 - 63 50	AK/XTU-65-SP 65
480 Y / 277 V	kA	–	...0.16 - 12 65	...16 - 40 65	–
		–	...16 42	...50 - 63 50	AK/XTUW-32-SP 65
		–	...20 - 32 18	...50 - 63 50	AK/XTU-65-SP 65
600 Y / 347 V	kA	–	...0.16 - 10 50	...16 - 40 25	–
		–	...12 18	...50 - 63 –	AK/XTUW-32-SP 25
		–	...16 - 32 –	...50 - 63 –	AK/XTU-65-SP –
Accessories required	–	...0.16 - 32 BK25/3-PKZ0-E	...16 - 63 BK50/3-PKZ4-E		
Short Circuit Current Rating, group protection					
600 V High Fault					
SCCR (fuse)	kA	Type	Type	Type	
		...0.16 - 6.3 50	...0.16 - 6.3 50	...16 - 63 42	100
		...10 30	...10 30		
		...12 18	...12 18		
max. Fuse	A	...0.16 - 12 600	...0.16 - 12 600	...16 - 63 600	100 Class J 200 Class J
		...16 - 25 150	...16 - 32 150		
SCCR (CB)	kA	...0.16 - 6.3 50	...0.16 - 6.3 50	...16 - 63 42	–
		...10 30	...10 30		
		...12 18	...12 18		
		...16 - 25 10	...16 - 32 10		
max. CB	A	...0.16 - 12 600	...0.16 - 12 600	...16 - 63 600	–
		...16 - 25 125	...16 - 32 125		
SCCR with CL (fuse)	A	...0.16 - 12 –	...0.16 - 12 –	–	–
		...16 50	...16 50		
		...20 - 25 18	...20 - 32 18		
max. Fuse (with CL)	A	...0.16 - 12 –	...0.16 - 12 –	–	–
		...16 - 25 600	...16 - 32 600		
SCCR with CL (CB)	kA	...0.16 - 12 –	...0.16 - 12 –	–	–
		...20 - 25 18	...16 50		
			...20 - 32 18		
max. CB (with CL)	A	...0.16 - 12 –	...0.16 - 12 –	–	–
		...16 - 25 600	...16 - 32 600		

			NHI...PKZ0	NHI-E-...PKZ0	VHI...PKZ0	AGM
Auxiliary contact						
Operating ambient temperature		°C	-25 - 55	-25 - 55	-25 - 55	-25 - 55
Rated impulse withstand voltage	U_{imp}	V AC	6000	4000	4000	6000
Overvoltage category/degree of pollution			III/3	III/3	III/3	III/3
Rated operating voltage	U_e	V AC	500	440	440	500
	U_e	V DC	250	250	250	250
Safe isolation according to EN 61140						
Between auxiliary contacts and main contacts		V AC	690	690	690	690
Rated operational current, AC-15						
220 - 240 V	I_e	A	3.5	1	1	3.5
380 - 415 V	I_e	A	2	–	–	2
440 - 500 V	I_e	A	1	–	–	1
Rated operational current, DC-13 L/R $\leq 100 \text{ ms}^1$						
24 V	I_e	A	2	2	2	2
60 V	I_e	A	1	–	–	1
110 V	I_e	A	0.5	–	–	0.5
220 V	I_e	A	0.25	–	–	0.25
Lifespan, mechanical	Operations	$\times 10^6$	> 0.1	> 0.1	> 0.1	> 0.01
Lifespan, electrical	Operations	$\times 10^6$	> 0.05	> 0.1	> 0.1	> 0.05
Contact reliability (for $U_e = 24 \text{ V DC}$, $U_{min} = 17 \text{ V}$, $I_{min} = 5.4 \text{ mA}$)	Fault probability	λ	< 10^{-8} (i.e. less than one failure per 100 million switchings)			
Interlocked opposing contacts			yes	–	–	–
Short-circuit strength without welding						
fuseless			FAZ-B4/1-HI	–	–	FAZ-B4/1-HI
Fuse		A gG/gL	10	10	10	10
Terminal capacities						
solid or flexible conductor with ferrule		mm ²	0.75 - 2.5	0.75 - 1.5 (...PKZ0) 0.75 - 2.5 (...PKZ0-C)	0.75 - 1.5	0.75 - 2.5
Solid or stranded		AWG	18 - 14	18 - 16	18 - 16	18 - 14
Stripping length		mm	9	6 (10 PKZ0-C)	6	9
Rating data for approved types						
Pilot duty						
AC operated			A600	E150	E150	A600
DC operated			Q300	–	–	Q300
General Use						
AC		V	600	–	300	600
AC		A	5	–	0.5	5
DC		V	250	250	–	250
DC		A	1	0.5	–	1

Notes¹⁾ Switch-on and switch-off conditions based on DC-13, time constant as specified

			Undervoltage release U-PKZ...		Shunt release A-PKZ...	
General						
Operating ambient temperature		°C	-25 - 55		-25 - 55	
Terminal capacity						
solid or flexible conductor with ferrule		mm ²	1 x (0.75 - 2.5) 2 x (0.75 - 2.5)		1 x (0.75 - 2.5) 2 x (0.75 - 2.5)	
Solid or stranded		AWG	1 x (18 - 14) 2 x (18 - 14)		1 x (18 - 14) 2 x (18 - 14)	
Operating voltage	U_c	V AC	24 - 600		24 - 480	
Operating voltage	U_c	V DC	24 - 24		24 - 110	
Pick-up-/drop-out voltage	$x U_s$		0.85 - 1.1 / 0.7 - 0.35			
Operating range						
Alternating voltage		$x U_s$			0.7 - 1.1	
DC voltage (intermittent operation 5 s)		$x U_s$			0.7 - 1.1	
Power consumption, alternating voltage						
Pull-in power AC	Pick-up	VA	5		5	
Sealing AC	Hold	VA	3		3	
Power consumption, DC voltage						
Pull-in power DC	Pick-up	W	3		3	
Sealing DC	Hold	W	0.5		0.5	

Dimensions

Motor-protective circuit breakers

PKZM01...

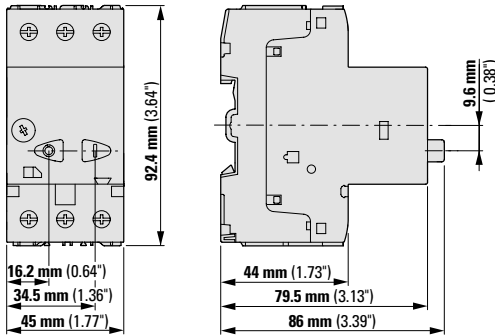

Motor-protective circuit breakers

Transformer-protective circuit breaker

Motor-protective circuit breaker with standard auxiliary contact

PKZM0-...(+NHI-E-...-PKZ0)

PKZM0-...-T(+NHI-E-...-PKZ0)

PKM0-...(+NHI-E-...-PKZ0)

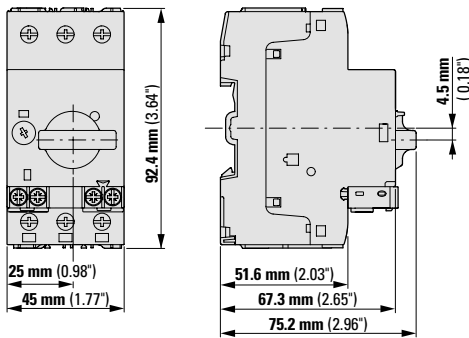

Motor-protective circuit breakers with lockable rotary handles

PKZM0-...+AK-PKZ0

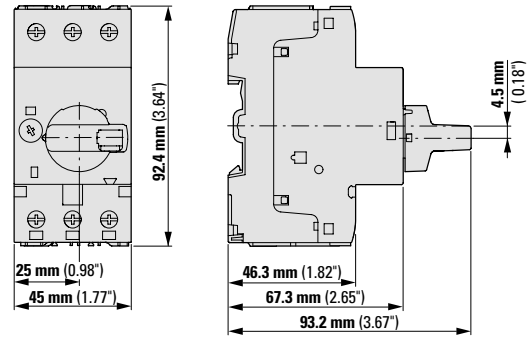

Current limiter

CL-PKZ...

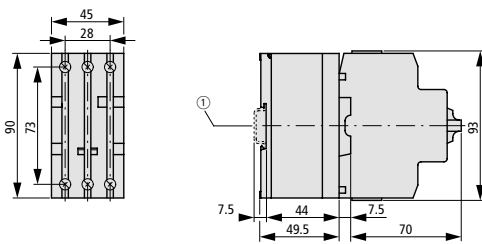

① Top-hat rail to IEC/EN 60715

Motor-protective circuit breakers with early-make auxiliary contacts

PKZM0-...+VHI-...-PKZ0

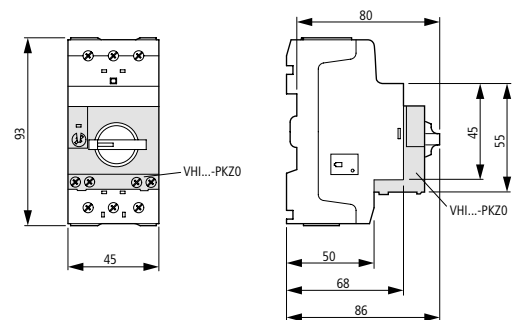

Standard auxiliary contact

NHI...-PKZ0

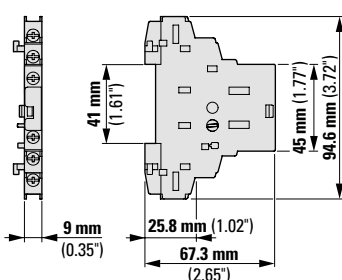

Trip-indicating auxiliary contact

AGM2...-PKZ0

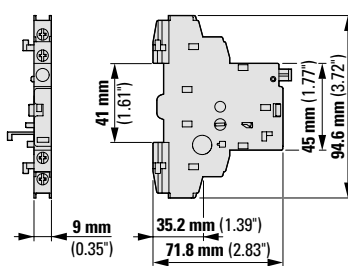

Shunt releases, undervoltage releases

A-PKZ0...

U-PKZ0...

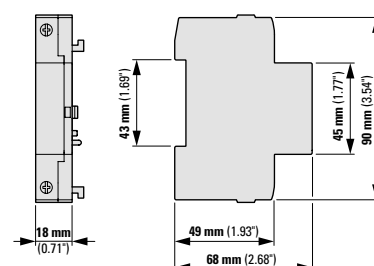

3.7

Motor-protective circuit breakers

Moeller series

Busbar adapter BBA

3

BBA0-25
BBA0-25/2TS
BBA0/2TS-L
BBA0-32
BBA0-32/2TS-C
BBA0C-16

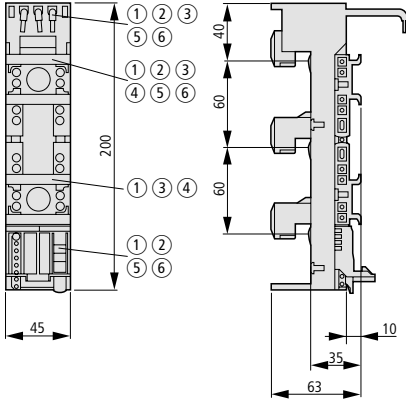

- ① BBA0-32/2TS-C ④ BBA0/2TS-L
- ② BBA0-25/2TS ⑤ BBA0-25
- ③ BBA0C-16 ⑥ BBA0-32

BBA2-63

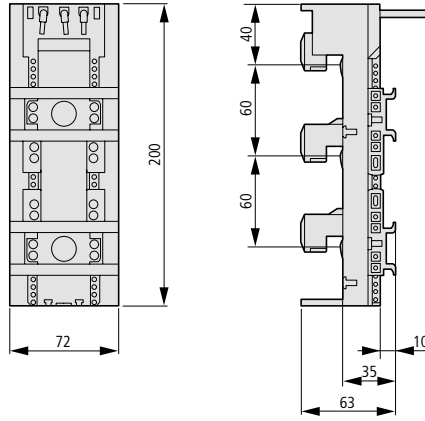

BBA4/2TS-L
BBA4L-63

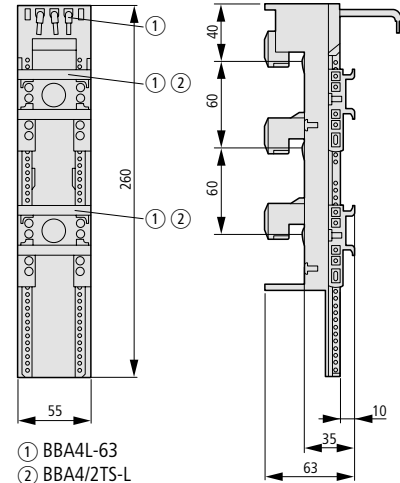

- ① BBA4L-63
- ② BBA4/2TS-L

BBA4-63

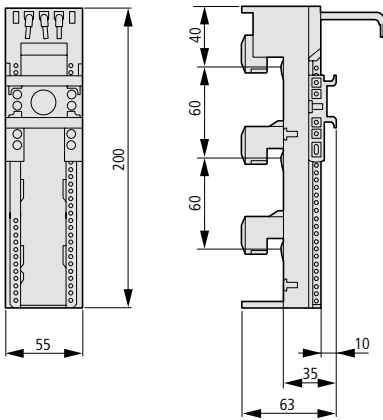

BBA2-80/2TS-S

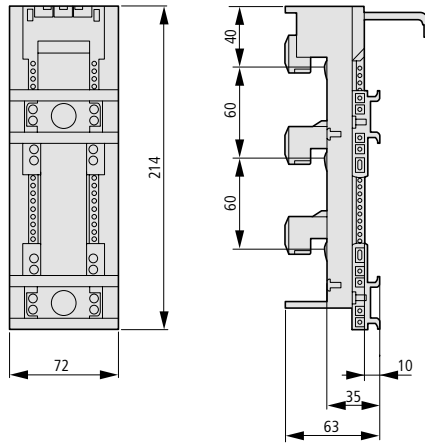

BBA2L-63

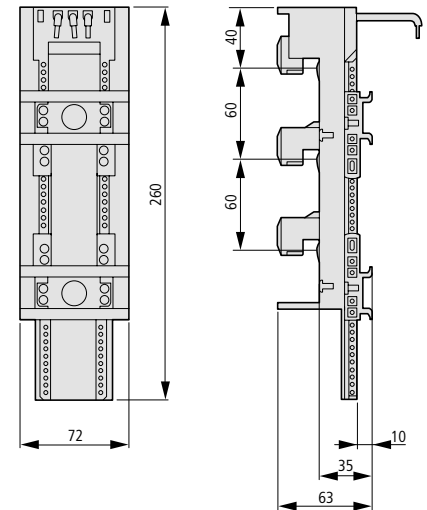

BBA0L-25
BBA0L-32

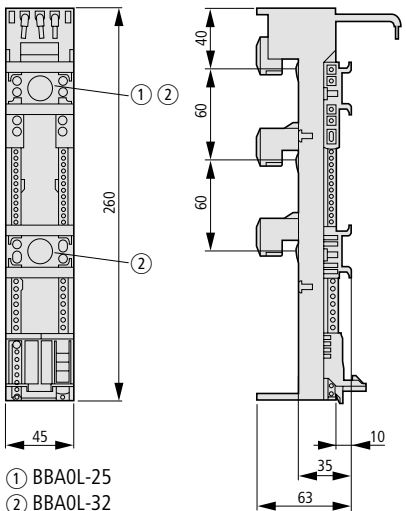

- ① BBA0L-25
- ② BBA0L-32

BBA0R-25

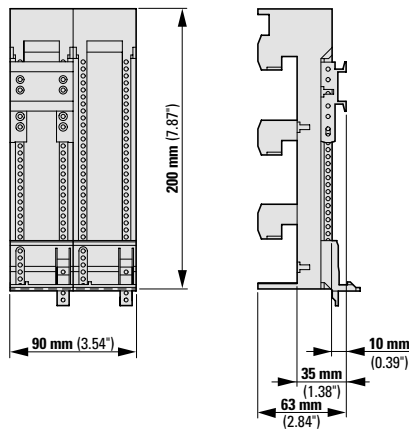

BBA0R-32

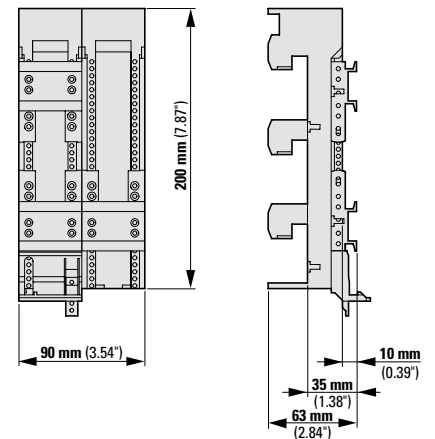

BBA0K-32

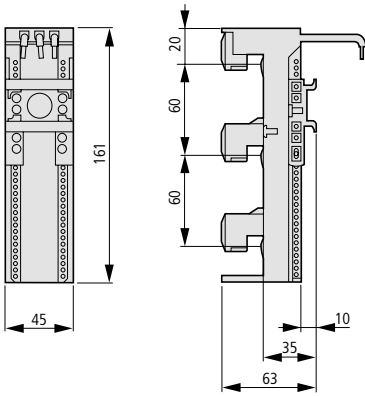

PKZM0-XC45

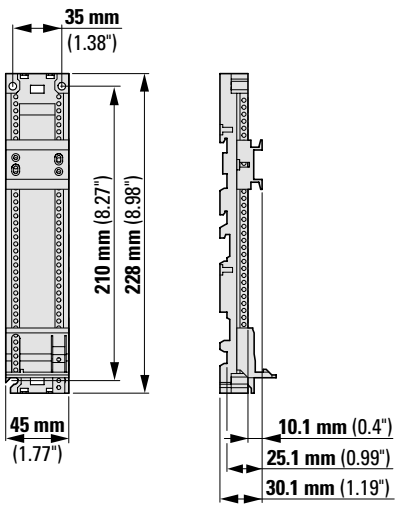

PKZM0-XC45L
PKZM0-XC45L-2

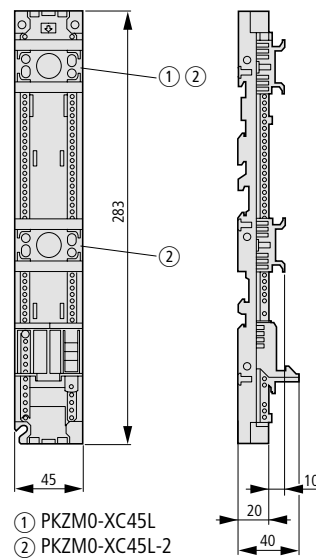

PKZM0-XC45-2

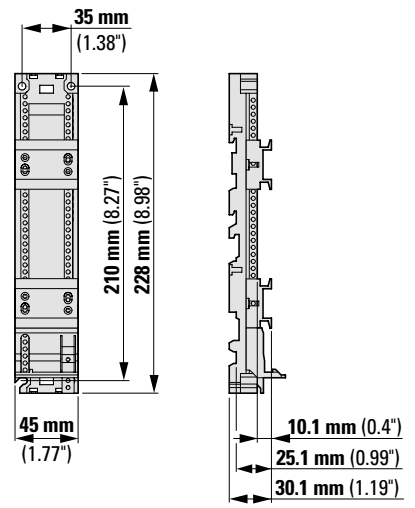

PKZM0-XC90-2

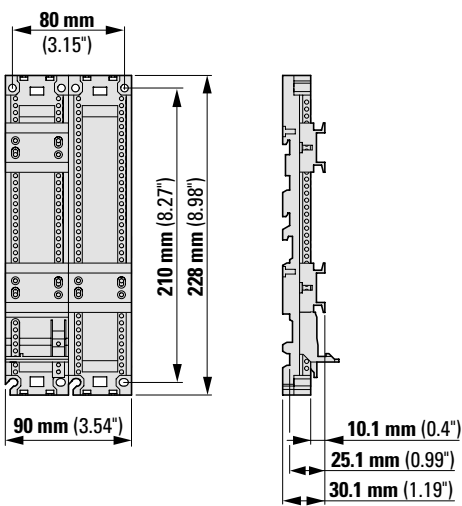

Insulated housing

3

Insulated enclosures for surface mounting

CI-PKZ0-M

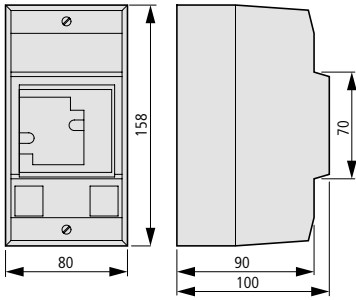

CI-PKZ0-G...M

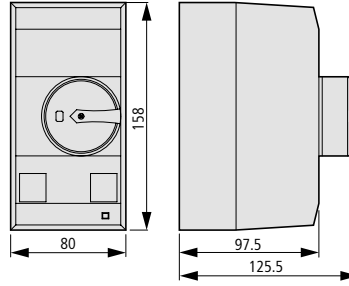

CI-PKZ0-...M
+ SVB-PKZ0-CI

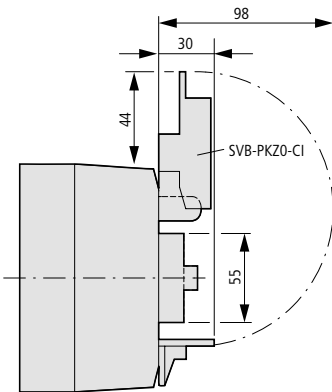

Drilling dimensions

CI-PKZ0-...M

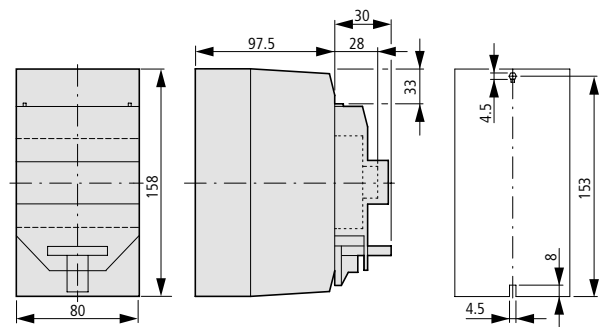

CI-K2(H)-PKZ0

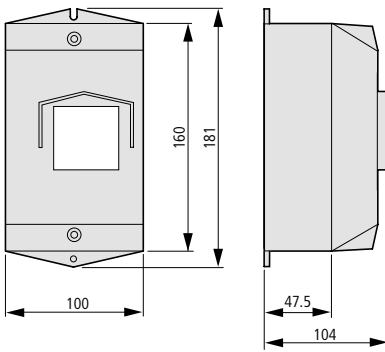

CI-K2(H)-PKZ0G(R)(V)

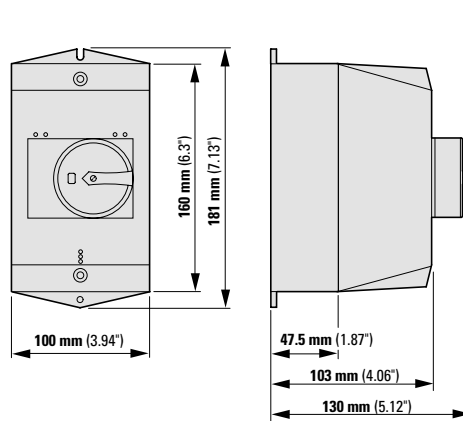

CI-K2(H)-PKZ0-G(R)(V)
+ SVB-PKZ0-CI

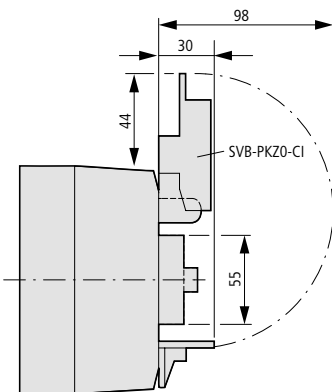

Drilling dimensions

CI-K2(H)-PKZ0...

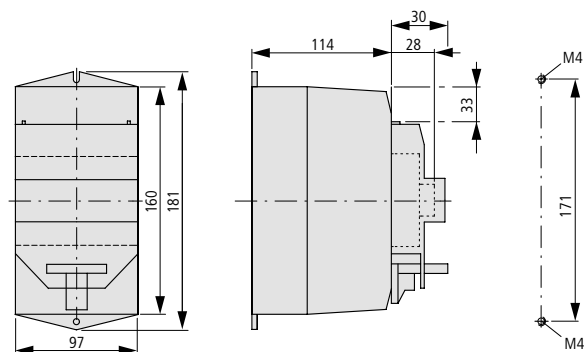

Door coupling handles

PKZ0-X(R)H...

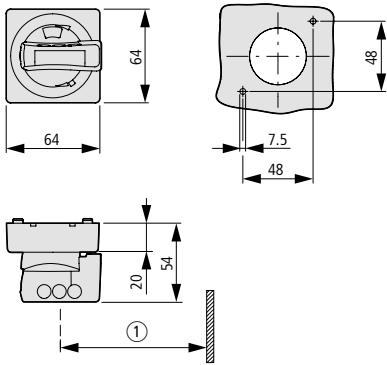

Mounting depth: 100 to 240 mm from the top edge of the top-hat rail to the front edge of the cabinet door/cover
Distance between operating axis/cover hinge: at least 100 mm

① at least 100 mm to cover hinge

3

Insulated enclosure for flush mounting

E-PKZ0 E-PKZ0-G...

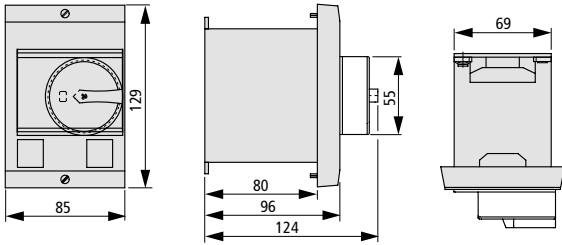

Mounting aperture E-PKZ0...

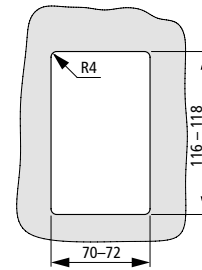

E-PKZ0-G...+SVB-PKZ0-E

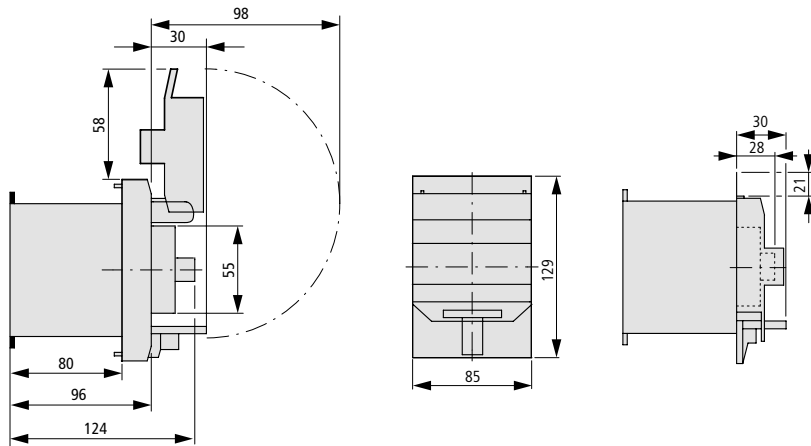

Insulated enclosures for surface mounting

CI-PKZ01
CI-PKZ01-G

CI-PKZ01-PVT
CI-PKZ01-PVS

CI-PKZ01-SVB
CI-PKZ01-SVB-V

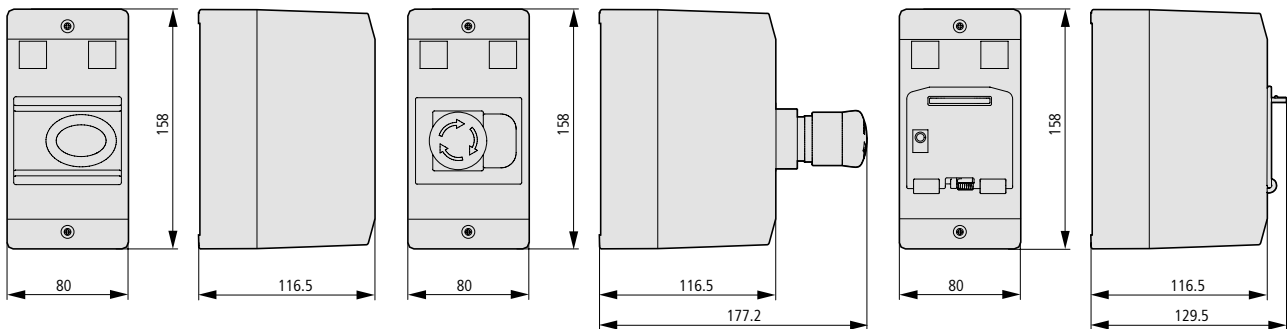

3

Insulated enclosure for flush mounting

E-PKZ01
E-PKZ01-G

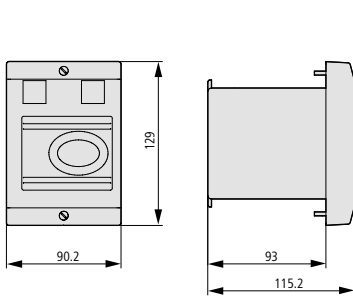

E-PKZ01-PVT
E-PKZ01-PVS

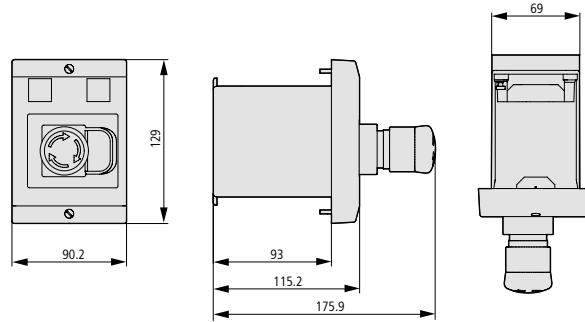

E-PKZ01-SVB
E-PKZ01-SVB-V

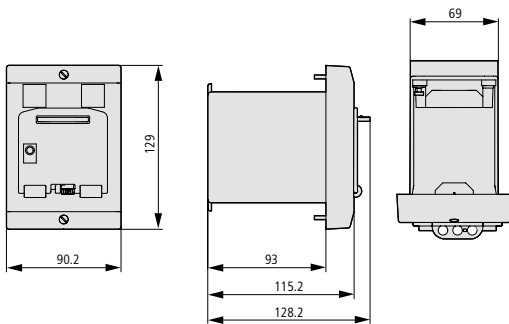

Motor-protective circuit breakers

PKZM4-...

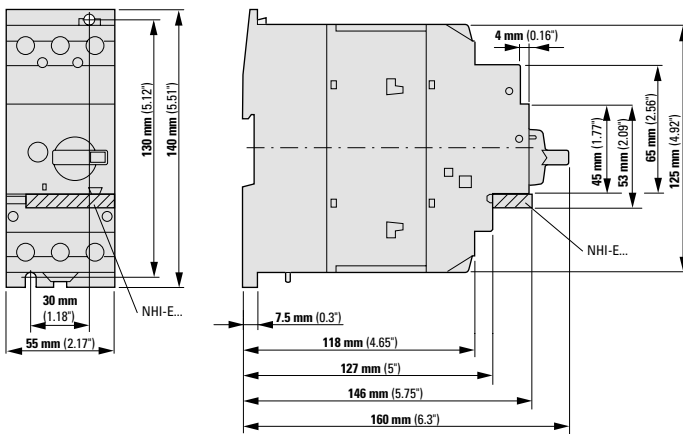

Motor-protective circuit breakers with lockable rotary handles

PKZM4-... +AK-PKZ0

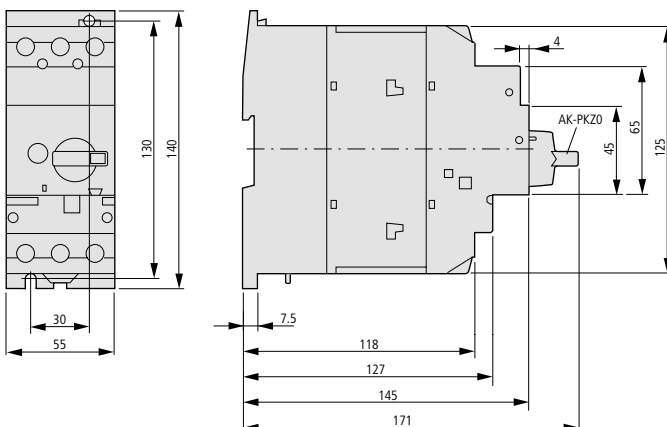

Three-phase commoning links

B3.0/4-PKZ4

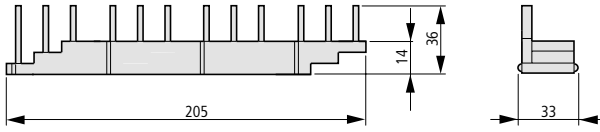

B3.1/4-PKZ4

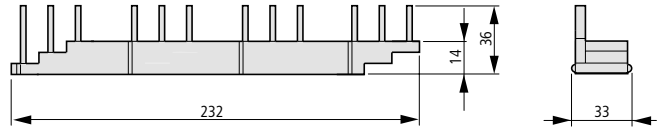

B3.0/3-PKZ4

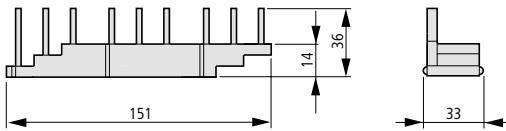

B3.1/3-PKZ4

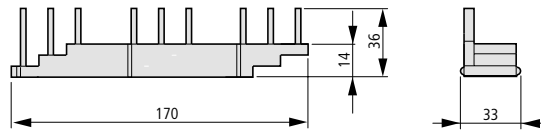

B3.0/2-PKZ4

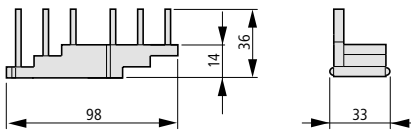

B3.1/2-PKZ4

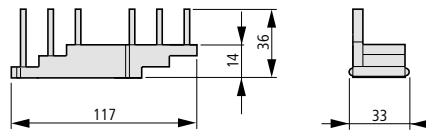

Three-phase commoning links

B3.0/5-PKZ0

B3.0/4-PKZ0

B3.0/3-PKZ0

B3.0/2-PKZ0

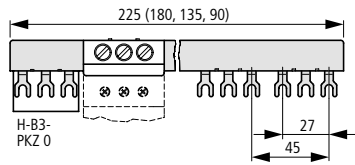

Three-phase commoning links

B3.2/4-PKZ0

B3.2/2-PKZ0

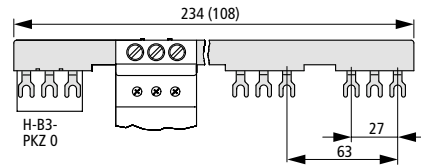

Three-phase commoning links

B3.1/5-PKZ0

B3.1/3-PKZ0

B3.1/4-PKZ0

B3.1/2-PKZ0

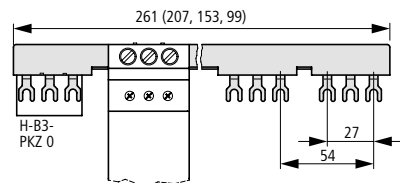

Connection clamp

BK25/3-PKZ0

Overlapping mounting to extend the commoning link

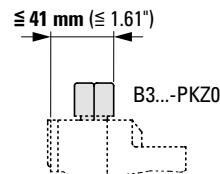
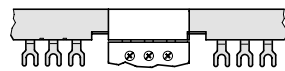
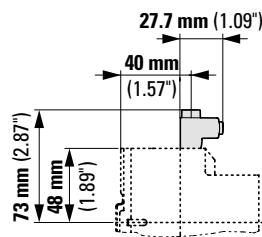

Insulated enclosures PKZM4

Insulated enclosures for surface mounting

CI-K4-PKZ4-(NA)-G(R)
+SVB-PKZ4-CI

CI-K4-PKZ4-(NA)-G(R)

3

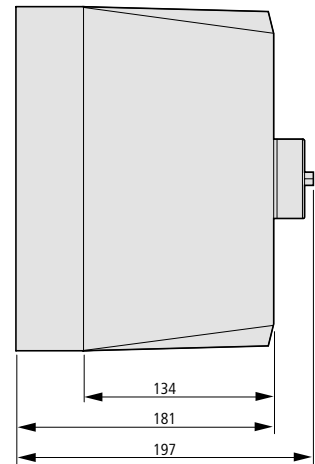
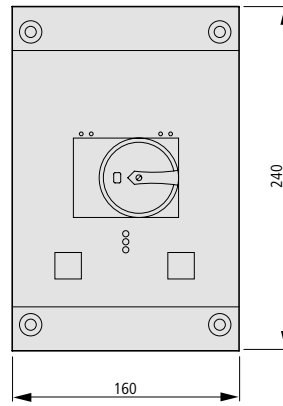
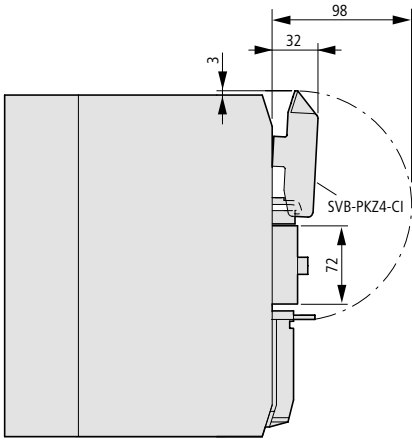

Drilling dimensions
CI-K4-PKZ4-(NA)-G(R)

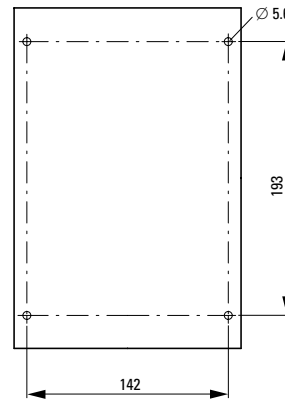
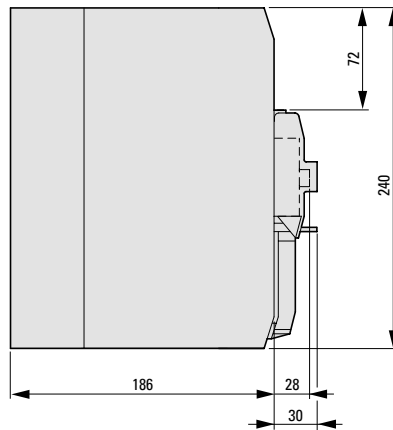
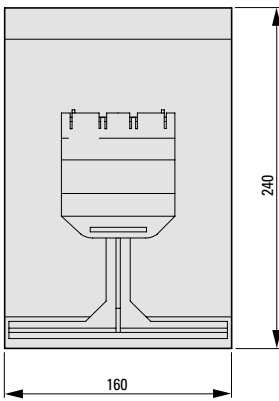

Overload relay module

PKE-XZMR

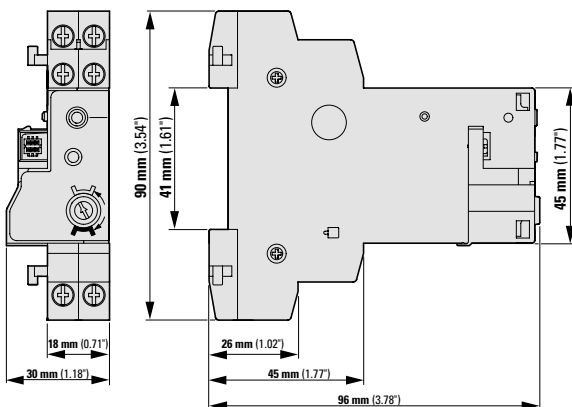

Motor-protective circuit breakers and system circuit breakers

Complete device with standard knob

Complete device with AK lockable rotary handle

PKE12

PKE32

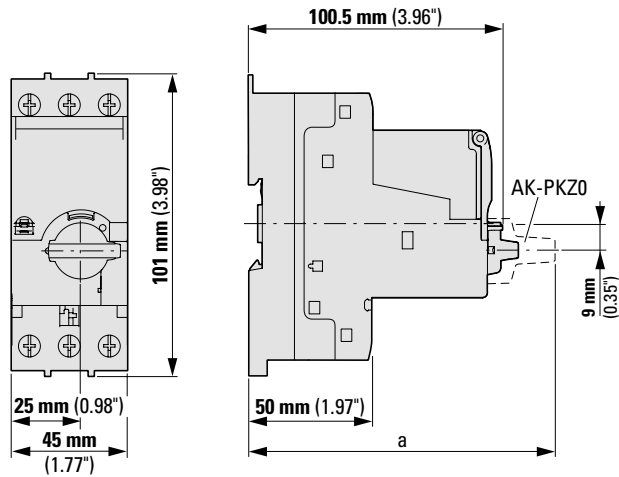

Type	a
PKE12/...	102.5
PKE12/AK...	120.5
PKE32/...	102.5
PKE32/AK...	120.5

PKE65

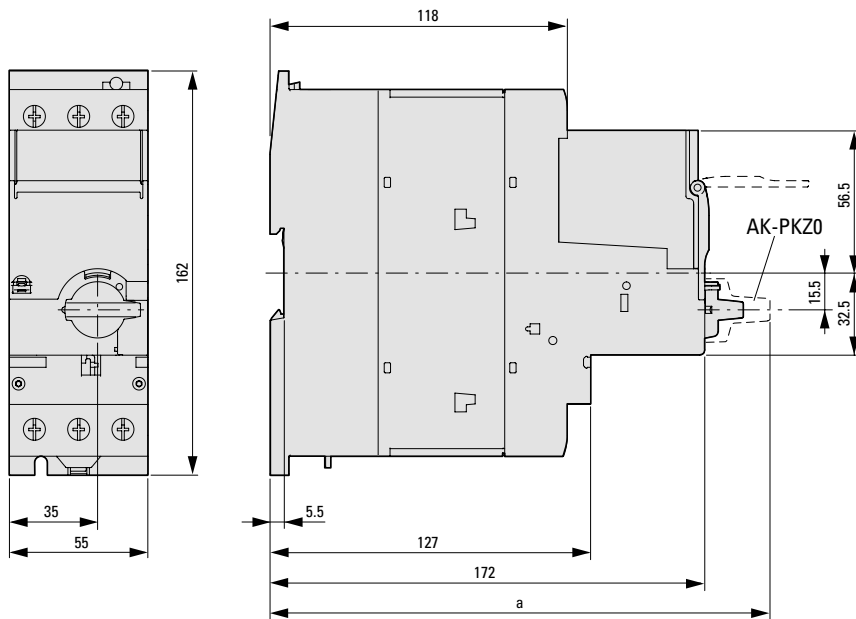

Type	a
PKE65/...	187
PKE65/AK...	198

SmartWire-DT PKE module (motor-starter combinations)

PKE-SWD-32

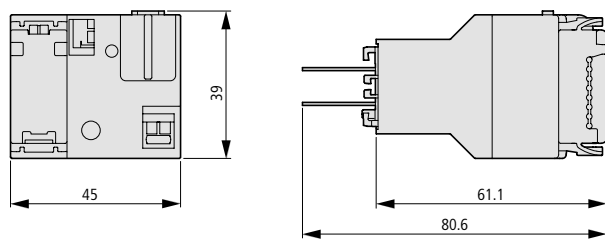

SmartWire-DT PKE module (motor-protective circuit breaker and system circuit breaker)

PKE-SWD-SP

PKE-SWD-CP

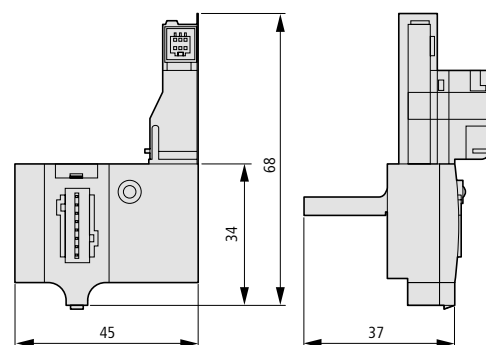

Build it in.



MSC motor-starter combinations: Fit and connect quickly and flexibly



The fuseless motor starters consist of a PKE motor-protective circuit breaker and a DILM contactor. The motor starters have been produced and recommended by Eaton for decades, particularly due to their large benefits for personal and operational security as well as the high reliability of the equipment.

They also facilitate the export of machines and electrical system equipment. The motor-starter combinations from Eaton enable the construction of compact, fuseless motor starters for the North American market, based on the latest guidelines. This makes it possible to design and construct the “world market control panel” with a standardized layout.

MSC-D







4.0	Motor-starter combinations	4/2
4.1	Product selection	4/2
	DOL starter – complete devices MSC-D	4/2
	DOL starter – complete devices MSC-DE	4/4
	DOL starter – complete devices MSC-DM	4/6
	DOL starter – complete devices MSC-DME	4/8
	DOL starter – complete devices MSC-D – actuating voltages	4/10
4.2	Module selection	4/12
	DOL starter – modules PKZM and DILM	4/12
	DOL starter – modules NZM and DILM	4/16
	DOL starter – modules PKM0, NZMN1, DILM and ZB	4/20
	DOL starter – modules PKM0, NZMN1, DILM and ZEB	4/22
	DOL starter – modules PKM0, NZM, DILM and ZEB	4/24
	DOL starter – modules NZM, DILM and ZEB	4/26
4.3	Product selection	4/28
	Reversing starters – complete devices MSC-R	4/28
4.4	Module selection	4/30
	Reversing starters – modules PKZM and DILM	4/30
	Reversing starters – modules NZM and DILM	4/32
4.5	Product selection	4/34
	DOL starter on busbar adapter – complete devices MSC-D	4/34
	DOL starter on busbar adapter – complete devices MSC-DM	4/36
	DOL starter on busbar adapter – complete devices MSC-R	4/38
	DOL starter type E – complete devices	4/40
4.6	Engineering	4/42
	Type F starter combinations PKZM, DILM, BK	4/42
	Type E starter combinations PKZM, DILM, BK	4/43
	Motor-starter combinations for North America	4/44
4.7	Technical data/dimensions	4/46

DOL starter – complete devices MSC-D

Product selection

4

Motor Data				Settings range		Motor starter actuating voltage 230 V 50 Hz	Std. pack
Motor rating	Rated operational current	Rated short-circuit current		Overload trip	Short-circuit releases	Type Article no.	
AC-3 380 V 400 V 415 V	AC-3 380 V 400 V 415 V	380 - 415 V Type "1" coordination Type "2" coordination					
P kW	I_e A	I_q kA	I_q kA	I_r A		I_{rm} A	
Complete devices MSC-D							
0.06	0.21	150	50	0.16 - 0.25	3.9	MSC-D-0.25-M7(230V50HZ)²⁾ 281925	1 pc.  
0.09	0.31	150	50	0.25 - 0.4	6.2	MSC-D-0.4-M7(230V50HZ)²⁾ 281926	
0.12	0.41	150	50	0.4 - 0.63	9.8	MSC-D-0.63-M7(230V50HZ)²⁾ 281927	
0.18	0.6	150	50				
0.25	0.8	150	50	0.63 - 1	15.5	MSC-D-1-M7(230V50HZ)²⁾ 281929	
0.37	1.1	150	50	1 - 1.6	24.8	MSC-D-1.6-M7(230V50HZ)²⁾ 283140	
0.55	1.5	150	50				
0.75	1.9	150	50	1.6 - 2.5	38.8	MSC-D-2.5-M7(230V50HZ)²⁾ 283142	
1.1	2.6	150	50	2.5 - 4	62	MSC-D-4-M7(230V50HZ)²⁾ 283143	
1.5	3.6	150	50				
2.2	5	150	50	4 - 6.3	97.7	MSC-D-6.3-M7(230V50HZ)²⁾ 283145	
3	6.6	150	-	6.3 - 10	155	MSC-D-10-M7(230V50HZ) 283146	
4	8.5	150	-	6.3 - 10	155	MSC-D-10-M9(230V50HZ) 283147	
5.5	11.3	50	-	8 - 12	186	MSC-D-12-M12(230V50HZ) 283148	
7.5	15.2	50	-	10 - 16	248	MSC-D-16-M15(230V50HZ)¹⁾ 100414	

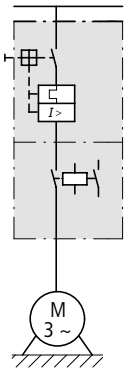
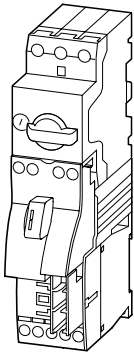

Motor starter actuating voltage 24 V DC
Type
 Article no.

Std. pack



Motor-protective circuit breakers

Contactors

DOL starter wiring set

Notes

Mechanical link module and electric contact module

		Type	Type	Type	
MSC-D-0.25-M7(24VDC)²⁾ 283154	1 pc. 	PKZM0-0.25	DILM7-10(...)	PKZM0-XDM12	 Also suitable for motors with efficiency class IE3. IE3-ready devices are identified by the logo on their packaging. ¹⁾ Not suitable for motors with efficiency class IE3. The DOL starter (complete devices) consists of a PKZM0 motor-protective circuit breaker and a DILM contactor. With the adapter-less top-hat rail mounting of starters up to 15 A, only the motor-protective circuit breaker on the top-hat rail requires an adapter. The contactors are provided with mechanical support via a mechanical connection element. Control wire guide with max. 6 conductors up to 2.5mm external diameter or 4 conductors up to 3.5mm external diameter. The connection of the main circuit between the motor-protective circuit breaker and the contactor is established using electric contact modules. When using the auxiliary contact DILA-XHIT... (→ page 1/46) the plug-in electrical connector can be removed without the removal of the top mounting auxiliary contact. Cannot be combined with NHI-E-...-PKZO-C standard auxiliary contact with spring-loaded terminal. ²⁾ Motor-starter combinations can be extended using extension terminal BK25/3-PKZO-E and, if necessary, with three-phase commoning links B3...-PKZO for type F starters according to UL508. Type F starter → page 4/42
MSC-D-0.4-M7(24VDC)²⁾ 283155		PKZM0-0.4	DILM7-10(...)	PKZM0-XDM12	
MSC-D-0.63-M7(24VDC)²⁾ 283156		PKZM0-0.63	DILM7-10(...)	PKZM0-XDM12	
MSC-D-1-M7(24VDC)²⁾ 283158		PKZM0-1	DILM7-10(...)	PKZM0-XDM12	
MSC-D-1.6-M7(24VDC)²⁾ 283159		PKZM0-1.6	DILM7-10(...)	PKZM0-XDM12	
MSC-D-2.5-M7(24VDC)²⁾ 283161		PKZM0-2.5	DILM7-10(...)	PKZM0-XDM12	
MSC-D-4-M7(24VDC)²⁾ 283162		PKZM0-4	DILM7-10(...)	PKZM0-XDM12	
MSC-D-6.3-M7(24VDC)²⁾ 283164		PKZM0-6.3	DILM7-10(...)	PKZM0-XDM12	
MSC-D-10-M7(24VDC) 283165		PKZM0-10	DILM7-10(...)	PKZM0-XDM12	
MSC-D-10-M9(24VDC) 283166		PKZM0-10	DILM9-10(...)	PKZM0-XDM12	
MSC-D-12-M12(24VDC) 283167		PKZM0-12	DILM12-10(...)	PKZM0-XDM12	
MSC-D-16-M15(24VDC)¹⁾ 100415		PKZM0-16	DILM15-10(...)	PKZM0-XDM12	

Further information	Page
Technical data PKZM0	→ 3/48
Accessories PKZ	→ 3/14
Technical data DILM	→ 1/114
DILM accessories	→ 1/64
Further actuating voltages	→ 4/10

Information relevant for export to North America



Product standards	IEC/EN 60947-4-1; UL 60947-4-1; CSA-C22.2 No. 60947-4-1-14; CE marking
UL File No.	E36332
UL CCN	NLRV
CSA File No.	12528
CSA Class No.	3211-24
NA Certification	UL listed, CSA certified

DOL starter – complete devices MSC-DE

4

Motor Power P kW	Rated motor current AC-3			Settings range Overload trigger I _r A	Standard motor starter Operating voltage 230 V 50 Hz Type Article no.	Std. pack
	220 V 230 V 240 V	380 V 400 V	415 V			
	I _q = 100 kA	I _q = 100 kA	I _q = 50 kA			

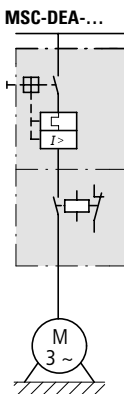
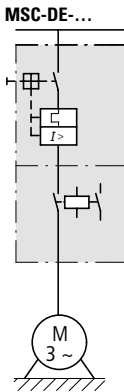
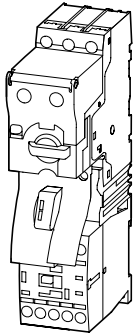

Complete devices MSC-DE – type “1” coordination

0.06	0.37	–	–	0.3 - 1.2	MSC-DE-1.2-M7(230V50HZ) 121735	1 pc.
0.09	0.54	0.31	0.31			
0.12	0.72	0.41	0.41			
0.18	1.04	0.6	0.6			
0.25	–	0.8	0.8			
0.37	–	1.1	1.1			
0.18	1.04	–	–	1 - 4	MSC-DE-4-M7(230V50HZ) 121737	
0.25	1.4	–	–			
0.37	2	1.1	1.1			
0.55	2.7	1.5	1.5			
0.75	3.2	1.9	1.9			
1.1	–	2.6	2.6			
1.5	–	3.6	3.6			
0.75	3.2	–	–	3 - 12	MSC-DE-12-M7(230V50HZ) 121739	
1.1	4.6	–	–			
1.5	6.3	3.6	3.6			
2.2	–	5	5			
3	–	6.6	6.6			
0.75	3.2	–	–	3 - 12	MSC-DE-12-M9(230V50HZ) 121741	
1.1	4.6	–	–			
1.5	6.3	3.6	3.6			
2.2	8.7	5	5			
3	–	6.6	6.6			
4	–	8.5	8.5			
0.75	3.2	–	–	3 - 12	MSC-DE-12-M12(230V50HZ) 121743	
1.1	4.6	–	–			
1.5	6.3	3.6	3.6			
2.2	8.7	5	5			
3	11.5	6.6	6.6			
4	–	8.5	8.5			
5.5	–	11.3	11.3			

Notes

in conjunction with SmartWire-DT module → page 3/24

Standard motor starter Operating voltage 24 V DC	Std. pack	Extended motor starter Operating voltage 24 V DC	Std. pack	Notes
Type Article no.		Type Article no.		



MSC-DE-1.2-M7(24VDC) 121736	1 pc.	MSC-DEA-1.2-M7(24VDC) 121753	1 pc.
---------------------------------------	-------	--	-------



Also suitable for motors with efficiency class IE3.
IE3-ready devices are identified by the logo on their packaging.

MSC-DE-4-M7(24VDC) 121738		MSC-DEA-4-M7(24VDC) 121754	
-------------------------------------	--	--------------------------------------	--

The DOL starter (complete devices) consists of a PKE motor-protective circuit breaker and a DILM contactor.

With the adapter-less top-hat rail mounting of starters up to 15 A, only the motor-protective circuit breaker on the top-hat rail requires an adapter.

The contactors are provided with mechanical support via a mechanical connection element. Control wire guide with max. 6 conductors up to 2.5mm external diameter or 4 conductors up to 3.5mm external diameter.

MSC-DE-12-M7(24VDC) 121740		MSC-DEA-12-M7(24VDC) 121755	
--------------------------------------	--	---------------------------------------	--

The connection of the main circuit between the motor-protective circuit breaker and the contactor is established with electric contact modules.

With DOL starter MSC-DE-... when using the auxiliary contact DILA-XHIT... the plug-in electrical connectors can be removed without removing the top mounting auxiliary contact.

Cannot be combined with NHI-E-...-PKZ0-C.

MSC-DE-12-M9(24VDC) 121742		MSC-DEA-12-M9(24VDC) 121756	
--------------------------------------	--	---------------------------------------	--



The MSC-DEA... DOL starters are prepared for communication via SmartWire-DT. For this, the PKE-SWD-32 communication module must be added.

MSC-DE-12-M12(24VDC) 121744		MSC-DEA-12-M12(24VDC) 121757	
---------------------------------------	--	--	--

Further information	Page
Technical data PKE	→ 3/48
Accessories PKE	→ 3/14
Technical data DILM	→ 1/114
DIL accessories	→ 1/64
Further actuating voltages	→ 1/83

DOL starter – complete devices MSC-DM

4

Motor Data				Settings range		Motor starter
Motor Rating	Rated operational current	Rated short-circuit current		Overload trigger	Short-circuit releases	Actuating voltage 230 V 50 Hz
AC-3 380 V 400 V 415 V	AC-3 380 V 400 V 415 V	380 - 415 V				Type Article no.
P kW	I_e A	I_q kA	I_q kA	I_r A	I_{rm} A	
		Type of coordination "1"	Type of coordination "2"			
MSC-DM complete devices						
0.06	0.21	150	50	0.16 - 0.25	3.9	MSC-DM-0.25-M7(230V50HZ) 188279
0.09	0.31	150	50	0.25 - 0.4	6.2	MSC-DM-0.4-M7(230V50HZ) 188280
0.12 0.18	0.41 0.6	150	50	0.4 - 0.63	9.8	MSC-DM-0.63-M7(230V50HZ) 188281
0.25	0.8	150	50	0.63 - 1	15.5	MSC-DM-4-M7(230V50HZ) 188282
0.37 0.55	1.1 1.5	150	50	1 - 1.6	24.8	MSC-DM-1.6-M7(230V50HZ) 188283
0.75	1.9	150	50	1.6 - 2.5	38.8	MSC-DM-2.5-M7(230V50HZ) 188284
1.1 1.5	2.6 3.6	150	50	2.5 - 4	62	MSC-DM-4-M7(230V50HZ) 188285
2.2	5	150	50	4 - 6.3	97.7	MSC-DM-6.3-M7(230V50HZ) 188286
3	6.6	150	–	6.3 - 10	155	MSC-DM-10-M7(230V50HZ) 188287
4	8.5	150	–	6.3 - 10	155	MSC-DM-10-M9(230V50HZ) 188288
5.5	11.3	50	–	8 - 12	186	MSC-DM-12-M12(230V50HZ) 188289
7.5	15.2	50	–	10 - 16	248	MSC-DM-16-M15(230V50HZ)¹⁾ 188290
3 4	6.6 8.5	50	50	6.3 - 10	155	MSC-DM-10-M17(230V50HZ)²⁾ 192743
5.5	11.3	50	50	8 - 12	186	MSC-DM-12-M17(230V50HZ)²⁾ 192744
7.5	15.2	50	50	10 - 16	248	MSC-DM-16-M17(230V50HZ)²⁾ 192745
11	21.7	50	50	20 - 25	388	MSC-DM-25-M25(230V50HZ)²⁾ 192746
15	29.3	50	50	25 - 32	496	MSC-DM-32-M32(230V50HZ)²⁾ 192747

Notes





Information relevant for export to North America

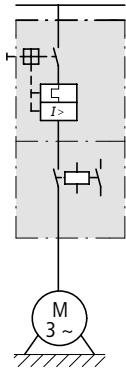
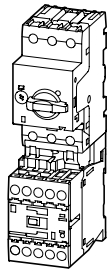

Product standards	UL 60947-4-1A; CSA-C22.2 No. 14-10; IEC 60947-4-1; CE marking
UL File No.	E123500
UL CCN	NKJH
CSA File No.	12528
CSA Class No.	3211-04
NA Certification	UL listed, CSA certified

²⁾ Request filed for UL and CSA



Motor starter Actuating voltage 24 V DC	Motor-protective circuit breaker	Contactor	DOL starter wiring set	Notes	
Std. pack Type Article no.	Std. pack	Type	Type	Type	
1 pc.  	1 pc.  	PKZM0-0.25	DILM7-10(...)	PKZM0-XDM15ME	 <p>Also suitable for motors with efficiency class IE3. IE3-ready devices are identified by the logo on their packaging.</p> <p>¹⁾ Not suitable for motors with efficiency class IE3.</p> <p>The DOL starter (complete device) consists of a PKZM0 motor protective circuit breaker and a DILM contactor.</p> <p>With the adapter-less top-hat rail mounting of starters up to 15 A, only the motor-protective circuit breaker on the top-hat rail requires an adapter.</p> <p>The contactors are provided with mechanical support via an electrical/mechanical connection element.</p> <p>Control wire guide with max. 6 conductors up to 2.5mm external diameter or 4 conductors up to 3.5mm external diameter.</p> <p>The connection of the main circuit between the motor-protective circuit breaker and the contactor is established with electric contact modules.</p>
MSC-DM-0.25-M7(24VDC) 188255		PKZM0-0.4	DILM7-10(...)	PKZM0-XDM15ME	
MSC-DM-0.4-M7(24VDC) 188256		PKZM0-0.63	DILM7-10(...)	PKZM0-XDM15ME	
MSC-DM-0.63-M7(24VDC) 188257		PKZM0-1	DILM7-10(...)	PKZM0-XDM15ME	
MSC-DM-4-M7(24VDC) 188258		PKZM0-1.6	DILM7-10(...)	PKZM0-XDM15ME	
MSC-DM-1.6-M7(24VDC) 188259		PKZM0-2.5	DILM7-10(...)	PKZM0-XDM15ME	
MSC-DM-2.5-M7(24VDC) 188260		PKZM0-4	DILM7-10(...)	PKZM0-XDM15ME	
MSC-DM-4-M7(24VDC) 188261		PKZM0-6.3	DILM7-10(...)	PKZM0-XDM15ME	
MSC-DM-6.3-M7(24VDC) 188262		PKZM0-10	DILM7-10(...)	PKZM0-XDM15ME	
MSC-DM-10-M7(24VDC) 188263		PKZM0-10	DILM9-10(...)	PKZM0-XDM15ME	
MSC-DM-10-M9(24VDC) 188264		PKZM0-12	DILM12-10(...)	PKZM0-XDM15ME	
MSC-DM-12-M12(24VDC) 188265		PKZM0-16	DILM15-10(...)	PKZM0-XDM15ME	
MSC-DM-16-M15(24VDC)¹⁾ 188266		PKZM0-10	DILM17-10(...)	PKZM0-XDM32ME	
MSC-DM-10-M17(24VDC)²⁾ 192748		PKZM0-12	DILM17-10(...)	PKZM0-XDM32ME	
MSC-DM-12-M17(24VDC)²⁾ 192749		PKZM0-16	DILM17-10(...)	PKZM0-XDM32ME	
MSC-DM-16-M17(24VDC)²⁾ 192750		PKZM0-25	DILM25-10(...)	PKZM0-XDM32ME	
MSC-DM-25-M25(24VDC)²⁾ 192751		PKZM0-32	DILM32-10(...)	PKZM0-XDM32ME	
MSC-DM-32-M32(24VDC)²⁾ 192752					

DOL starter – complete devices MSC-DME

Motor output Rated motor current

Settings range
Overload trigger

P [kW]	AC-3							I _r A	
	220 V 230 V 240 V	380 V 400 V	415 V	440 V	500 V	500 V with CL-PKZO	660 V 690 V		
	I _q = 100 kA	I _q = 100 kA	I _q = 65 kA	I _q = 65 kA	I _q = 10 kA ¹⁾ I _q = 50 kA	I _q = 100 kA	I _q = 3 kA		
Complete devices MSC-DME – type "2" coordination									
0.06	0.37	–	–	–	–	–	–	0.3 - 1.2	
0.09	0.54	0.31	0.31	–	–	–	–		
0.12	0.72	0.41	0.41	0.37	0.33	0.33	–		
0.18	1.04	0.6	0.6	0.54	0.48	0.48	0.35		
0.25	–	0.8	0.8	0.76	0.7	0.7	0.5		
0.37	–	1.1	1.1	1.02	0.9	0.9	0.7		
0.55	–	–	–	–	–	–	0.9		
0.75	–	–	–	–	–	–	1.1		
0.18	1.04	–	–	–	–	–	–	1 - 4	
0.25	1.4	–	–	–	–	–	–		
0.37	2	1.1	1.1	1.02	–	–	–		
0.55	2.7	1.5	1.5	1.39	1.2	1.2	–		
0.75	3.2	1.9	1.9	1.68	1.5	1.5	1.1		
1.1	–	2.6	2.6	2.41	2.1	2.1	1.5		
1.5	–	3.6	3.6	3.28	2.9	2.9	2.1		
2.2	–	–	–	–	4	4	2.9		
3	–	–	–	–	–	–	3.8		
0.75	3.2	–	–	–	–	–	–	3 - 12	
1.1	4.6	–	–	–	–	–	–		
1.5	6.3	3.6	3.6	3.3	–	–	–		
2.2	8.7	5	5	4.6	4	4	–		
3	11.5	6.6	6.6	6	5.3	5.3	3.8		
4	–	8.5	8.5	7.7	6.8	6.8	4.9		
5.5	–	11.3	11.3	10.2	9	9	6.5		
7.5	–	–	–	–	–	–	8.8		
2.2	8.7	–	–	–	–	–	–	8 - 32	
3	11.5	–	–	–	–	–	–		
4	14.8	8.5	8.5	–	–	–	–		
5.5	–	11.3	11.3	10.2	9	9	–		
7.5	–	15.2	15.2	13.8	12.1	12.1	8.8		
2.2	8.7	–	–	–	–	–	–	8 - 32	
3	11.5	–	–	–	–	–	–		
4	14.8	8.5	8.5	–	–	–	–		
5.5	19.6	11.3	11.3	10.2	9	9	–		
7.5	–	15.2	15.2	13.8	12.1	12.1	8.8		
11	–	21.7	21.7	19.7	17.4	17.4	12.6		
15	–	–	–	–	23.4	23.4	–		
2.2	8.7	–	–	–	–	–	–	8 - 32	
3	11.5	–	–	–	–	–	–		
4	14.8	8.5	8.5	–	–	–	–		
5.5	19.6	11.3	11.3	10.2	9	9	–		
7.5	26.4	15.2	15.2	13.8	12.1	12.1	8.8		
11	–	21.7	21.7	19.7	17.4	17.4	12.6		
15	–	29.3	29.3	26.6	23.4	23.4	17		
18.5	–	–	–	–	28.9	28.9	–		

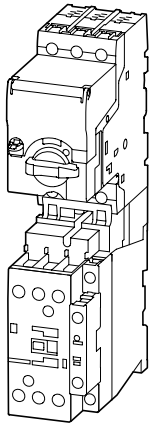

MSC-DME-...

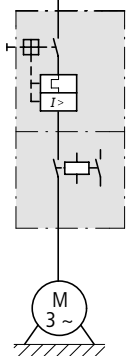

MSC-DMEA-...

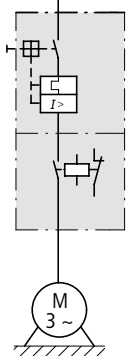

Standard motor starter Operating voltage 230 V 50 Hz		Standard motor starter Operating voltage 24 V DC		Extended motor starter Operating voltage 24 V DC		Notes
Type	Std. pack	Type	Std. pack	Type	Std. pack	
Article no.		Article no.		Article no.		



MSC-DME-1.2-M17(230V50HZ) ¹⁾ 192753	1 pc. 	MSC-DME-1.2-M17(24VDC) ¹⁾ 192759	1 pc. 	MSC-DMEA-1.2-M17(24VDC) ¹⁾ 192765	1 pc.
--	-----------	---	-----------	--	-----------



Also suitable for motors with efficiency class IE3. IE3-ready devices are identified by the logo on their packaging.

MSC-DME-4-M17(230V50HZ)
192754

MSC-DME-4-M17(24VDC)
192760

MSC-DMEA-4-M17(24VDC)
192766

The connection of the main circuit between the motor-protective circuit breaker and the contactor is established with electric/mechanical contact modules.

The MSC-DEA... DOL starters are prepared for communication via SmartWire-DT. For this, the PKE-SWD-32 communication module must be added.

Information relevant for export to North America



¹⁾ Request filed for UL and CSA

MSC-DME-12-M17(230V50HZ)
192755

MSC-DME-12-M17(24VDC)
192761

MSC-DMEA-12-M17(24VDC)
192767

MSC-DME-32-M17(230V50HZ)
192756

MSC-DME-32-M17(24VDC)
192762

MSC-DMEA-32-M17(24VDC)
192768

MSC-DME-32-M25(230V50HZ)
192757

MSC-DME-32-M25(24VDC)
192763

MSC-DMEA-32-M25(24VDC)
192769

MSC-DME-32-M32(230V50HZ)
192758

MSC-DME-32-M32(24VDC)
192764

MSC-DMEA-32-M32(24VDC)
192770

in conjunction with SmartWire-DT module → page 3/24

DOL starter – complete devices MSC-D – actuating voltages

		MSC-D-0.25-M7	MSC-D-0.4-M7	MSC-D-0.63-M7	MSC-D-1-M7	MSC-D-1.6-M7	MSC-D-2.5-M7
		Article no.	Article no.	Article no.	Article no.	Article no.	Article no.
Standard voltages							
AC	24V50HZ	115937	115938	115939	115940	115941	115942
	240V50HZ	115915	115916	115917	115918	115919	115920
	110V50Hz,120V60Hz	115893	115894	115895	115896	115897	115898
	24V50/60HZ	115926	115927	115928	115929	115930	115931
	110V50/60HZ	115442	115443	115444	115445	115446	115447
	230V50/60HZ	115904	115905	115906	115907	115908	115909
		MSC-D-4-M7	MSC-D-6.3-M7	MSC-D-10-M7	MSC-D-10-M9	MSC-D-12-M12	MSC-D-16-M15
		Article no.	Article no.	Article no.	Article no.	Article no.	Article no.
Standard voltages							
AC	24V50HZ	115943	115944	115945	115946	115947	
	240V50HZ	115921	115922	115923	115924	115925	
	110V50HZ,120V60HZ	115899	115900	115901	115902	115903	
	24V50/60HZ	115932	115933	115934	115935	115936	
	110V50/60HZ	115448	115449	115890	115891	115892	
	230V50/60HZ	115910	115911	115912	115913	115914	116075
		MSC-DM-0.25-M7	MSC-DM-0.4-M7	MSC-DM-0.63-M7	MSC-DM-1-M7	MSC-DM-1.6-M7	MSC-DM-2.5-M7
		Article no.	Article no.	Article no.	Article no.	Article no.	Article no.
Standard voltages							
AC	230V50/60HZ	188267	188268	188269	188270	188271	188272
		MSC-DM-4-M7	MSC-DM-6.3-M7	MSC-DM-10-M7	MSC-DM-10-M9	MSC-DM-12-M12	MSC-DM-16-M15
		Article no.	Article no.	Article no.	Article no.	Article no.	Article no.
Standard voltages							
AC	230V50/60HZ	188273	188274	188275	188276	188277	188278

Module selection

4

Motor Data				Settings range	
Motor Rating	Rated operational current	Rated short-circuit current		Overload trigger	short-circuit release
AC-3	AC-3	380 - 415 V			
380 V	380 V	Type of coordination "1"	Type of coordination "2"		
400 V	400 V				
415 V	415 V				
P	I_e	I_q	I_q	I_r	I_{rm}
kW	A	kA	kA	A	A

Modules PKZM0 and DILM

0.06	0.21	150	50	0.16 - 0.25	3.9
0.09	0.31	150	50	0.25 - 0.4	6.2
0.12	0.41	150	50	0.4 - 0.63	9.8
0.18	0.6	150	50	0.4 - 0.63	9.8
0.25	0.8	150	50	0.63 - 1	15.5
0.37	1.1	150	50	1 - 1.6	24.8
0.55	1.5	150	50	1 - 1.6	24.8
0.75	1.9	150	50	1.6 - 2.5	38.8
1.1	2.6	150	50	2.5 - 4	62
1.5	3.6	150	50	2.5 - 4	62
2.2	5	150	50	4 - 6.3	97.7
3	6.6	150	50	6.3 - 10	155
4	8.5	150	50	6.3 - 10	155
5.5	11.3	50	50	8 - 12	186
7.5	15.2	50	50	10 - 16	248
11	21.7	50	50	20 - 25	388
15	29.3	50	50	25 - 32	496

Modules PKZM4 and DILM

5.5	11.3	50	50	10 - 16	248
7.5	15.2	50	50	10 - 16	248
11	21.7	50	50	16 - 25	388
15	29.3	50	50	24 - 32	496
18.5	36	50	50	32 - 40	620
22	41	50	50	40 - 50	775
30	55	50	50	50 - 58	899
34	63	50	50	55 - 65	1008

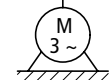
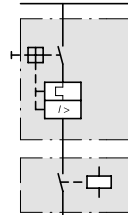
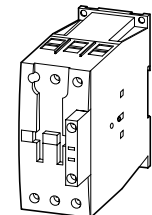
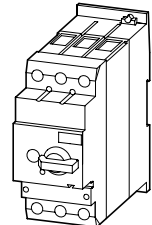
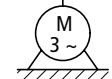
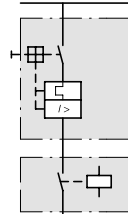
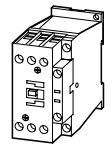
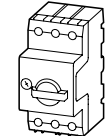

Motor protective circuit breaker	Contactor	Contactor	Notes
	Type of coordination "1"	Type of coordination "2"	



Type	Type	Type	
PKZM0-0.25	DILM7-...(...)	DILM7-...(...)	<p>The motor-starter combination consists of the motor protective circuit breaker or circuit breaker and contactor. They conform to IEC/EN 60947-4-1 or VDE 0660 Part 102. I_q = rated conditional short-circuit current</p> <p>Further information</p> <p>Technical data PKZM0 → 3/48</p> <p>Accessories PKZ → 3/14</p> <p>Technical data DILM → 1/114</p> <p>DILM accessories → 1/64</p> <p>Further actuating voltages → 1/83</p>
PKZM0-0.4	DILM7-...(...)	DILM7-...(...)	
PKZM0-0.63	DILM7-...(...)	DILM7-...(...)	
PKZM0-0.63	DILM7-...(...)	DILM7-...(...)	
PKZM0-1	DILM7-...(...)	DILM7-...(...)	
PKZM0-1.6	DILM7-...(...)	DILM7-...(...)	
PKZM0-1.6	DILM7-...(...)	DILM7-...(...)	
PKZM0-2.5	DILM7-...(...)	DILM7-...(...)	
PKZM0-4	DILM7-...(...)	DILM7-...(...)	
PKZM0-4	DILM7-...(...)	DILM7-...(...)	
PKZM0-6.3	DILM7-...(...)	DILM7-...(...)	
PKZM0-10	DILM7-...(...)	DILM17-...(...)	
PKZM0-10	DILM9-...(...)	DILM17-...(...)	
PKZM0-12	DILM12-...(...)	DILM17-...(...)	
PKZM0-16	DILM15-...(...)	DILM17-...(...)	
PKZM0-25	DILM25-...(...)	DILM25-...(...)	
PKZM0-32	DILM32-...(...)	DILM32-...(...)	

PKZM4-16	DILM17-...(...)	DILM17-...(...)	<p>The motor-starter combination consists of the motor protective circuit breaker or circuit breaker and contactor. They conform to IEC/EN 60947-4-1 or VDE 0660 Part 102. I_q = rated conditional short-circuit current</p> <p>Further information</p> <p>Technical data PKZM0 → 3/48</p> <p>Accessories PKZ → 3/14</p> <p>Technical data DILM → 1/114</p> <p>DILM accessories → 1/64</p> <p>Further actuating voltages → 1/83</p>
PKZM4-16	DILM17-...(...)	DILM17-...(...)	
PKZM4-25	DILM25-...(...)	DILM25-...(...)	
PKZM4-32	DILM32-...(...)	DILM32-...(...)	
PKZM4-40	DILM40(...)	DILM40(...)	
PKZM4-50	DILM50(...)	DILM50(...)	
PKZM4-58	DILM65(...)	DILM65(...)	
PKZM4-63	DILM65(...)	DILM65(...)	

DOL starter – modules PKZM and DILM

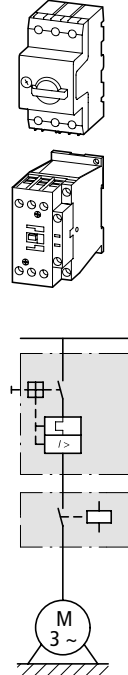
4



Motor Data				Settings range	
Motor Rating	Rated operational current	Rated short-circuit current		Overload trigger	short-circuit release
AC-3 500 V P kW	AC-3 500 V I_e A	500 V Type of coordination "1" I_q kA	500 V Type of coordination "2" I_q kA	I_r A 	I_{rm} A 
Modules PKZM0 and DILM					
0.06	0.17	100	50	0.16 - 0.25	3.9
0.09	0.25	100	50	0.25 - 0.4	6.2
0.12	0.33	100	50	0.25 - 0.4	6.2
0.18	0.48	100	50	0.4 - 0.63	9.8
0.25	0.7	100	50	0.63 - 1	15.5
0.37	0.9	100	50	0.63 - 1	15.5
0.55	1.2	100	50	1 - 1.6	24.8
0.75	1.5	100	50	1 - 1.6	24.8
1.1	2.1	100	50	1.6 - 2.5	38.8
1.5	2.9	100	50	2.5 - 4	62
2.2	4	42	18	4 - 6.3	97.7
2.2	4	–	50	4 - 6.3	97.7
3	5.3	42	18	4 - 6.3	97.7
3	5.3	–	50	4 - 6.3	97.7
4	6.8	42	18	6.3 - 10	155
4	6.8	–	50	6.3 - 10	155
5.5	9	42	18	6.3 - 10	155
5.5	9	–	50	6.3 - 10	155
6.5	10.6	42	18	8 - 12	186
6.5	10.6	–	50	8 - 12	186
7.5	12.1	15	18	10 - 16	248
7.5	12.1	–	50	10 - 16	248
11	17.4	6	–	16 - 20	310
11	17.4	15	–	16 - 20	310
15	23.4	6	–	20 - 25	388
15	23.4	15	–	20 - 25	388
18.5	28.9	6	–	25 - 32	496
18.5	28.9	15	–	25 - 32	496
Modules PKZM4 and DILM					
11	17.4	50	50	16 - 25	388
15	23.4	50	50	16 - 25	388
18.5	28.9	50	50	24 - 32	496
22	33	50	50	32 - 40	620
30	44	50	50	40 - 50	775
37	54	50	50	50 - 58	899
45	65	50	50	55 - 65	1008

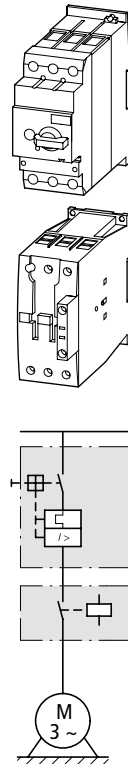

Motor protective circuit breaker	Notes		Current limiter
	Contactor	Contactor	
	Type of coordination "1"	Type of coordination "2"	
Type	Type	Type	Type
PKZM0-0.25	DILM7-...(…)	DILM7-...(…)	–
PKZM0-0.4	DILM7-...(…)	DILM7-...(…)	–
PKZM0-0.4	DILM7-...(…)	DILM7-...(…)	–
PKZM0-0.63	DILM7-...(…)	DILM7-...(…)	–
PKZM0-1	DILM7-...(…)	DILM7-...(…)	–
PKZM0-1	DILM7-...(…)	DILM7-...(…)	–
PKZM0-1.6	DILM7-...(…)	DILM7-...(…)	–
PKZM0-1.6	DILM7-...(…)	DILM7-...(…)	–
PKZM0-2.5	DILM7-...(…)	DILM7-...(…)	–
PKZM0-4	DILM7-...(…)	DILM7-...(…)	–
PKZM0-6.3	DILM7-...(…)	DILM7-...(…)	–
PKZM0-6.3	–	DILM17-...(…)	CL-PKZO
PKZM0-6.3	DILM7-...(…)	DILM7-...(…)	–
PKZM0-6.3	–	DILM17-...(…)	CL-PKZO
PKZM0-10	DILM9-...(…)	DILM17-...(…)	–
PKZM0-10	–	DILM17-...(…)	CL-PKZO
PKZM0-10	DILM9-...(…)	DILM17-...(…)	–
PKZM0-10	–	DILM17-...(…)	CL-PKZO
PKZM0-12	DILM12-...(…)	DILM17-...(…)	–
PKZM0-12	–	DILM17-...(…)	CL-PKZO
PKZM0-16	DILM17-...(…)	DILM17-...(…)	–
PKZM0-16	–	DILM17-...(…)	CL-PKZO
PKZM0-20	DILM25-...(…)	–	–
PKZM0-20	DILM25-...(…)	–	CL-PKZO
PKZM0-25	DILM25-...(…)	–	–
PKZM0-25	DILM25-...(…)	–	CL-PKZO
PKZM0-32	DILM32-...(…)	–	–
PKZM0-32	DILM32-...(…)	–	CL-PKZO
PKZM4-25	DILM40(…)	DILM40(…)	–
PKZM4-25	DILM40(…)	DILM40(…)	–
PKZM4-32	DILM40(…)	DILM40(…)	–
PKZM4-40	DILM40(…)	DILM40(…)	–
PKZM4-50	DILM50(…)	DILM50(…)	–
PKZM4-58	DILM65(…)	DILM65(…)	–
PKZM4-63	DILM65(…)	DILM65(…)	–

The motor-starter combination consists of the motor protective circuit breaker or circuit breaker and contactor. They conform to IEC/EN 60947-4-1 or VDE 0660 Part 102. I_q = rated conditional short-circuit current.



Further information	Page
Technical data PKZM...	→ 3/48
PKZM accessories...	→ 3/14
Technical data DILM	→ 1/114
DILM accessories	→ 1/64
Further actuating voltages	→ 1/83

The motor-starter combination consists of the motor protective circuit breaker or circuit breaker and contactor. They conform to IEC/EN 60947-4-1 or VDE 0660 Part 102. I_q = rated conditional short-circuit current.

Further information	Page
Technical data PKZM...	→ 3/48
PKZM accessories...	→ 3/14
Technical data DILM	→ 1/114
DILM accessories	→ 1/64
Further actuating voltages	→ 1/83

DOL starter – modules NZM and DILM

4

Motor Data			Settings range	
Motor Rating	Rated operational current	Rated short-circuit current	Overload trigger	short-circuit release
AC-3	AC-3			
380 V	380 V	400 V		
400 V	400 V	415 V		
415 V	415 V			
P	I_e	I_n	I_r	I_{rm}
kW	A	kA	A 	A 

Modules NZMN and DILM

18.5	36	50	32 - 40	320 - 560
22	41	50	40 - 50	400 - 700
30	55	50	50 - 63	504 - 882
37	68	50	63 - 80	640 - 1120
45	81	50	80 - 100	800 - 1250
55	99	50	80 - 100	800 - 1250
75	134	50	125 - 160	1280 - 2240
90	161	50	160 - 200	1600 - 2800
110	196	50	160 - 200	1600 - 2800
132	231	50	175 - 350	350 - 4900
160	279	50	175 - 350	350 - 4900
200	349	50	175 - 350	350 - 4900
250	437	50	225 - 450	450 - 6300
315	544	50	275 - 550	550 - 7700
400	683	50	438 - 875	875 - 12250
450	750	50	438 - 875	875 - 12250
500	820	50	438 - 875	875 - 12250
560	947	50	700 - 1400	1400 - 19600

Modules NZMH and DILM

22	41	100	40 - 50	400 - 700
30	55	100	50 - 63	504 - 882
37	68	100	63 - 80	640 - 1120
45	81	100	80 - 100	800 - 1400
55	100	100	100 - 125	1000 - 1750
75	134	100	125 - 160	1280 - 2240
30	55	100	45 - 90	90 - 1260
37	68	100	45 - 90	90 - 1260
45	81	100	45 - 90	90 - 1260
55	100	100	70 - 140	140 - 1960
75	134	100	70 - 140	140 - 1960
90	161	100	110 - 120	220 - 3080
110	196	100	110 - 120	220 - 3080
132	231	100	175 - 350	350 - 4900
160	279	100	175 - 350	350 - 4900
200	349	100	175 - 350	350 - 4900

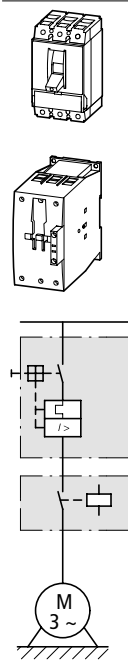
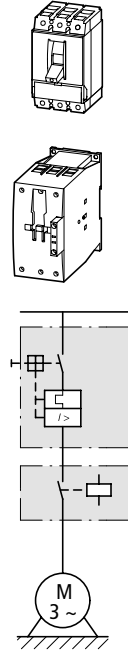

Notes

Circuit breaker	Contactors	Contactors
	Type of coordination "1"	Type of coordination "2"

Type	Type	Type	
NZMN1-M40	DILM40(...)	DILM80(...)	The motor-starter combination consists of the motor protective circuit breaker or circuit breaker and contactor. They conform to IEC/EN 60947-4-1 or VDE 0660 Part 102. I_q = rated conditional short-circuit current
NZMN1-M50	DILM50(...)	DILM80(...)	
NZMN1-M63	DILM65(...)	DILM80(...)	
NZMN1-M80	DILM80(...)	DILM80(...)	
NZMN1-M100	DILM95(...)	DILM95(...)	
NZMN1-M100	DILM115(...)	DILM115(...)	
NZMN2-M160	DILM150(...)	DILM150(...)	
NZMN2-M200	DILM185A/22(...)	DILM185A/22(...)	
NZMN2-M200	DILM225A/22(...)	DILM225A/22(...)	
NZMN3-ME350	DILM250/22(...)	DILM250/22(...)	
NZMN3-ME350	DILM300A/22(...)	DILM300A/22(...)	
NZMN3-ME350	DILM400/22(...)	DILM400/22(...)	
NZMN3-ME450	DILM500/22(...)	DILM500/22(...)	
NZMN4-ME550	DILM580/22(...)	–	
NZMN4-ME875	DILM650/22(...)	–	
NZMN4-ME875	DILM750/22(...)	–	
NZMN4-ME875	DILM820/22(...)	–	
NZMN4-ME1400	DILM1000/22(...)	–	

NZMH2-M50	DILM80(...)	DILM80(...)	The motor-starter combination consists of the motor protective circuit breaker or circuit breaker and contactor. They conform to IEC/EN 60947-4-1 or VDE 0660 Part 102. I_q = rated conditional short-circuit current
NZMH2-M63	DILM80(...)	DILM80(...)	
NZMH2-M80	DILM80(...)	DILM80(...)	
NZMH2-M100	DILM95(...)	DILM95(...)	
NZMH2-M125	DILM115(...)	DILM115(...)	
NZMH2-M160	DILM150(...)	DILM150(...)	
NZMH2-ME90	DILM80(...)	DILM80(...)	
NZMH2-ME90	DILM80(...)	DILM80(...)	
NZMH2-ME90	DILM95(...)	DILM95(...)	
NZMH2-ME140	DILM115(...)	DILM115(...)	
NZMH2-ME140	DILM150(...)	DILM150(...)	
NZMH2-ME220	DILM185A/22(...)	DILM185A/22(...)	
NZMH2-ME220	DILM225A/22(...)	DILM225A/22(...)	
NZMH3-ME350	DILM250/22(...)	DILM250/22(...)	
NZMH3-ME350	DILM300A/22(...)	DILM300A/22(...)	
NZMH3-ME350	DILM400/22(...)	DILM400/22(...)	

DOL starter – modules NZM and DILM

4

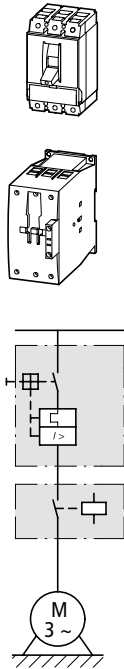

Motor Data				Settings range	
Motor rating	Rated operational current		Rated short-circuit current	Overload trigger	Short-circuit releases
AC-3					
500 V 525 V	500 V	525 V	500 V 525 V		
P kW	I_e A	I_e A	I_q kA	I_r A	I_{rm} A
Modules NZMH and DILM					
11	17.4	17	50	16 - 20	350 - 350
15	23.4	22.5	50	20 - 25	350 - 350
18.5	28.9	28	50	25 - 32	320 - 448
22	33	32	50	32 - 40	320 - 560
30	44	43	50	40 - 50	400 - 700
37	54	54	50	50 - 63	504 - 882
45	65	64	50	63 - 80	640 - 1120
55	79	78	50	63 - 80	640 - 1120
75	107	106	50	100 - 125	1000 - 1750
90	129	127	50	125 - 160	1280 - 2240
30	44	43	50	45 - 90	90 - 1260
37	54	54	50	45 - 90	90 - 1260
45	65	64	50	45 - 90	90 - 1260
55	79	78	50	45 - 90	90 - 1260
75	107	106	50	70 - 140	140 - 1960
90	129	127	50	70 - 140	140 - 1960

Notes

Circuit breaker	Contactors	Contactors
	Type of coordination "1"	Type of coordination "2"

Type	Type	Type	Notes
NZMH2-M20	DILM40(...)	DILM80(...)	The motor-starter combination consists of the motor protective circuit breaker or circuit breaker and contactor. They conform to IEC/EN 60947-4-1 or VDE 0660 Part 102. I_q = rated conditional short-circuit current
NZMH2-M25	DILM40(...)	DILM80(...)	
NZMH2-M32	DILM40(...)	DILM80(...)	
NZMH2-M40	DILM40(...)	DILM80(...)	
NZMH2-M50	DILM80(...)	DILM80(...)	
NZMH2-M63	DILM80(...)	DILM80(...)	
NZMH2-M80	DILM80(...)	DILM80(...)	
NZMH2-M80	DILM80(...)	DILM80(...)	
NZMH2-M125	DILM115(...)	DILM115(...)	
NZMH2-M160	DILM150(...)	DILM150(...)	
NZMH2-ME90	DILM80(...)	DILM80(...)	
NZMH2-ME90	DILM80(...)	DILM80(...)	
NZMH2-ME90	DILM80(...)	DILM80(...)	
NZMH2-ME90	DILM80(...)	DILM80(...)	
NZMH2-ME140	DILM115(...)	DILM115(...)	
NZMH2-ME140	DILM150(...)	DILM150(...)	

DOL starter – modules PKM0, NZMN1, DILM and ZB

4

Motor Data			Settings range		Basic device Motor-protective circuit breaker, circuit breaker
Motor Rating	Rated operational current	Rated conditional short-circuit current	Overload trigger	short-circuit release	

AC-3	AC-3			
380 V	380 V	380 V		
400 V	400 V	400 V		
415 V	415 V	415 V		

P	I_e	I_q	I_r	I_{rm}	Type
kW	A	kA	A	A	

Modules PKM0, DILM and ZB with and without automatic reset

0.06	0.21	100	0.16 - 0.24	3.9	PKM0-0.25
0.09	0.31	100	0.24 - 0.4	6.2	PKM0-0.4
0.12	0.41	100	0.4 - 0.6	9.8	PKM0-0.63
0.18	0.6	100	0.4 - 0.6	9.8	PKM0-0.63
0.25	0.8	100	0.6 - 1	15.5	PKM0-1
0.37	1.1	100	1 - 1.6	24.8	PKM0-1.6
0.55	1.5	100	1 - 1.6	24.8	PKM0-1.6
0.75	1.9	100	1.6 - 2.4	38.8	PKM0-2.5
1.1	2.6	100	2.4 - 4	62	PKM0-4
1.5	3.6	100	2.4 - 4	62	PKM0-4
2.2	5	100	4 - 6	97.7	PKM0-6.3
3	6.6	100	6 - 10	155	PKM0-10
4	8.5	100	6 - 10	155	PKM0-10
5.5	11.3	50	8 - 12	186	PKM0-12
5.5	11.3	50	10 - 16	186	PKM0-12
7.5	15.2	50	10 - 16	248	PKM0-16
11	21.7	50	16 - 24	388	PKM0-25
15	29.3	50	20 - 32	496	PKM0-32

Modules NZMN1, DILM and ZB with and without automatic reset

18.5	36	50	24 - 40	320 - 560	NZMN1-S40
22	41	50	40 - 57	400 - 700	NZMN1-S50
30	55	50	40 - 57	504 - 882	NZMN1-S63
37	68	50	50 - 70	640 - 1120	NZMN1-S80
45	81	50	70 - 100	800 - 1250	NZMN1-S100
55	99	50	70 - 100	800 - 1250	NZMN1-S100

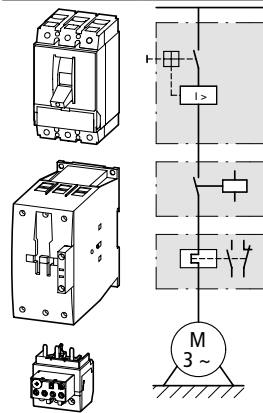
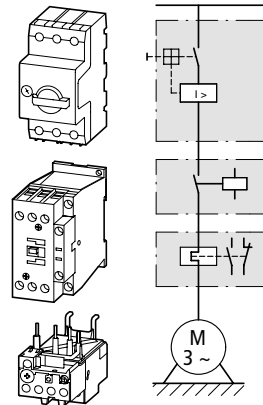

DOL starter – modules PKM0, NZMN1, DILM and ZB

Contactor Motor protection relay Contactor Motor protection relay Notes
 Type of coordination "1" Type of coordination "1" Type of coordination "2" Type of coordination "2"

Type	Type	Type	Type	
DILM7-...(…)	ZB12-0.24	DILM7-...(…)	ZB12-0.24	The motor-starter combinations consist of the motor-protective circuit breaker (without overload function), contactor and overload relay modules. They conform to IEC/EN 60947-4-1 or VDE 0660 Part 102. I_q = rated conditional short-circuit current
DILM7-...(…)	ZB12-0.4	DILM7-...(…)	ZB12-0.4	
DILM7-...(…)	ZB12-0.6	DILM7-...(…)	ZB12-0.6	
DILM7-...(…)	ZB12-0.6	DILM7-...(…)	ZB12-0.6	
DILM7-...(…)	ZB12-1	DILM7-...(…)	ZB12-1	The combinations can be operated with or without reclose blocking. In the manual position, the combination is blocked against automatic restarting. It must be reset locally. In the Auto position, the combination automatically switches on again when the bimetallic elements have cooled down.
DILM7-...(…)	ZB12-1.6	DILM7-...(…)	ZB12-1.6	
DILM7-...(…)	ZB12-1.6	DILM7-...(…)	ZB12-1.6	
DILM7-...(…)	ZB12-2.4	DILM7-...(…)	ZB12-2.4	
DILM7-...(…)	ZB12-4	DILM7-...(…)	ZB12-4	
DILM7-...(…)	ZB12-4	DILM7-...(…)	ZB12-4	
DILM7-...(…)	ZB12-6	DILM17-...(…)	ZB32-6	Further information Page Technical data PKM → 3/48 Accessories PKZ → 3/14
DILM9-...(…)	ZB12-10	DILM17-...(…)	ZB32-10	Technical data DILM → 1/114
DILM9-...(…)	ZB12-10	DILM17-...(…)	ZB32-10	DIL accessories → 1/64
DILM12-...(…)	ZB12-12	–	–	Technical data ZB → 2/22
–	–	DILM17-...(…)	ZB32-16	Accessories ZB → 2/19
DILM17-...(…)	ZB32-16	DILM17-...(…)	ZB32-16	Further actuating voltages → 1/83
DILM25-...(…)	ZB32-24	DILM25-...(…)	ZB32-24	
DILM32-...(…)	ZB32-32	DILM32-...(…)	ZB32-32	
DILM40(…)	ZB65-40	–	–	The motor-starter combinations consist of the circuit breaker (without overload function), contactor and overload relay module. They conform to IEC/EN 60947-4-1 or VDE 0660 Part 102. I_q = rated conditional short-circuit current
DILM50(…)	ZB65-57	–	–	
DILM65(…)	ZB65-57	–	–	The combinations can be operated with or without reclose blocking. In the manual position, the combination is blocked against automatic restarting. It must be reset locally. In the Auto position, the combination automatically switches on again when the bimetallic elements have cooled down. Maximum trigger tolerance: CLASS 10
DILM80(…)	ZB150-70	–	–	
DILM95(…)	ZB150-100	–	–	
DILM115(…)	ZB150-100	–	–	
				Further information Page Technical data NZMN1 → Online catalog Accessories for NZM1 → Online catalog Technical data DILM → 1/114 DIL accessories → 1/64 Technical data ZB → 2/22 Accessories ZB → 2/19 Further actuating voltages → 1/84

DOL starter – modules PKM0, NZMN1, DILM and ZEB

4

Motor Data			Settings range		Basic device Motor-protective circuit breaker, circuit breaker
Motor rating	Rated operational current	Rated short-circuit current	Overload trigger	short-circuit release	
AC-3	AC-3				
380 V	380 V	380 V			
400 V	400 V	400 V			
415 V	415 V	415 V			
P	I_e	I_q	I_r	I_{lm}	Type
kW	A	kA	A	A	

Modules PKM0, DILM and ZEB with and without reclose blocking

0.12	0.41	100	0.33 - 1.65	3.9	PKM0-0.63
0.18	0.6	100	0.33 - 1.65	3.9	PKM0-0.63
0.25	0.8	100	0.33 - 1.65	15.5	PKM0-1
0.37	1.1	100	0.33 - 1.65	24.8	PKM0-1.6
0.55	1.5	100	0.33 - 1.65	24.8	PKM0-1.6
0.75	1.9	100	1 - 5	38.8	PKM0-2.5
1.1	2.6	100	1 - 5	62	PKM0-4
1.5	3.6	100	1 - 5	62	PKM0-4
2.2	5	50	4 - 20	97.7	PKM0-6.3
3	6.6	50	4 - 20	155	PKM0-10
4	8.5	50	4 - 20	155	PKM0-10
5.5	11.3	50	4 - 20	186	PKM0-12
7.5	15.2	50	4 - 20	248	PKM0-16
11	21.7	50	9 - 45	388	PKM0-25
15	29.3	50	9 - 45	496	PKM0-32

Modules NZMN1, DILM and ZEB with and without reclose blocking

0.37	1.1	50	1 - 5	320 - 560	NZMN1-S40
0.55	1.5	50	1 - 5	320 - 560	NZMN1-S40
0.75	1.9	50	1 - 5	320 - 560	NZMN1-S40
1.1	2.6	50	1 - 5	320 - 560	NZMN1-S40
1.5	3.6	50	1 - 5	320 - 560	NZMN1-S40
2.2	5	50	4 - 20	320 - 560	NZMN1-S40
3	6.6	50	4 - 20	320 - 560	NZMN1-S40
4	8.5	50	4 - 20	320 - 560	NZMN1-S40
5.5	11.3	50	4 - 20	320 - 560	NZMN1-S40
7.5	15.2	50	4 - 20	320 - 560	NZMN1-S40
11	21.7	50	9 - 45	320 - 560	NZMN1-S40
15	29.3	50	9 - 45	320 - 560	NZMN1-S40
18.5	36	50	9 - 45	320 - 560	NZMN1-S40
22	41	50	9 - 45	400 - 700	NZMN1-S50
30	55	50	20 - 100	504 - 882	NZMN1-S63
37	68	50	20 - 100	640 - 1120	NZMN1-S80
45	81	50	20 - 100	800 - 1250	NZMN1-S100
55	99	50	20 - 100	800 - 1250	NZMN1-S100
75	134	50	35 - 175	1280 - 2240	NZMN2-S160
90	161	50	35 - 175	1600 - 2500	NZMN2-S200

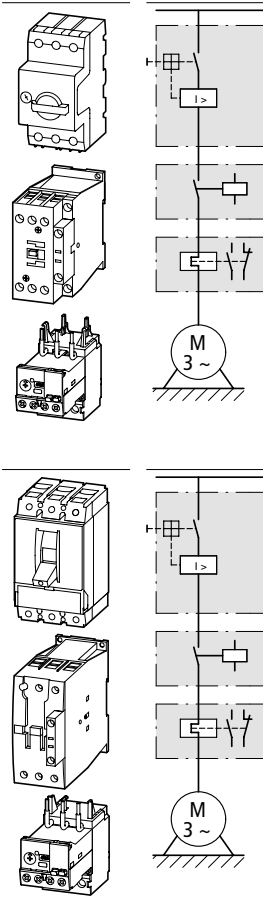



DOL starter – modules PKM0, NZMN1, DILM and ZEB

Contactor	Motor protection relay	Contactor	Motor protection relay	Notes
Type of coordination "1"	Type of coordination "1"	Type of coordination "2"	Type of coordination "2"	

Type	Type	Type	Type	
DILM7-...(…)	ZEB12-1.65	DILM7-...(…)	ZEB12-1.65	The motor-starter combinations consist of the motor-protective circuit breaker or circuit breaker (without overload function), contactor and overload relay modules. They conform to IEC/EN 60947-4-1 or VDE 0660 Part 102. I_q = rated conditional short-circuit current
DILM7-...(…)	ZEB12-1.65	DILM7-...(…)	ZEB12-1.65	
DILM7-...(…)	ZEB12-1.65	DILM7-...(…)	ZEB12-1.65	
DILM7-...(…)	ZEB12-1.65	DILM7-...(…)	ZEB12-1.65	
DILM7-...(…)	ZEB12-1.65	DILM7-...(…)	ZEB12-1.65	
DILM7-...(…)	ZEB12-5	DILM7-...(…)	ZEB12-5	
DILM7-...(…)	ZEB12-5	DILM7-...(…)	ZEB12-5	
DILM7-...(…)	ZEB12-5	DILM7-...(…)	ZEB12-5	
DILM7-...(…)	ZEB12-20	DILM17-...(…)	ZEB12-20	
DILM7-...(…)	ZEB12-20	DILM17-...(…)	ZEB12-20	
DILM9-...(…)	ZEB12-20	DILM17-...(…)	ZEB12-20	Further information Technical data PKM0 → 3/48 Technical data NZMN → Online catalog NZM accessories → Online catalog Accessories PKZ → 3/14 Technical data DILM → 1/114 DIL accessories → 1/64 Technical data ZEB → 2/26 Accessories ZEB → 2/18 Further actuating voltages → 1/83
DILM12-...(…)	ZEB12-20	DILM17-...(…)	ZEB12-20	
DILM17-...(…)	ZEB12-20	DILM17-...(…)	ZEB12-20	
DILM25-...(…)	ZEB32-45	DILM25-...(…)	ZEB32-45	
DILM32-...(…)	ZEB32-45	DILM32-...(…)	ZEB32-45	
DILM40(…)	ZEB32-5/KK	DILM40(…)	ZEB32-5/KK	
DILM40(…)	ZEB32-5/KK	DILM40(…)	ZEB32-5/KK	
DILM40(…)	ZEB32-5/KK	DILM40(…)	ZEB32-5/KK	
DILM40(…)	ZEB32-5/KK	DILM40(…)	ZEB32-5/KK	
DILM40(…)	ZEB32-20/KK	DILM40(…)	ZEB32-20/KK	
DILM40(…)	ZEB32-20/KK	DILM40(…)	ZEB32-20/KK	
DILM40(…)	ZEB32-20/KK	DILM40(…)	ZEB32-20/KK	
DILM40(…)	ZEB32-20/KK	DILM40(…)	ZEB32-20/KK	
DILM40(…)	ZEB32-20/KK	DILM40(…)	ZEB32-20/KK	
DILM40(…)	ZEB32-45/KK	DILM40(…)	ZEB32-45/KK	
DILM40(…)	ZEB32-45/KK	DILM40(…)	ZEB32-45/KK	
DILM40(…)	ZEB65-45	DILM40(…)	ZEB65-45	
DILM50(…)	ZEB65-45	DILM50(…)	ZEB65-45	
DILM65(…)	ZEB65-100	DILM60(…)	ZEB65-100	
DILM80(…)	ZEB150-100	DILM80(…)	ZEB150-100	
DILM95(…)	ZEB150-100	DILM95(…)	ZEB150-100	
DILM115(…)	ZEB150-100	DILM115(…)	ZEB150-100	
DILM150(…)	ZEB150-175	DILM150(…)	ZEB150-175	
DILM170(…)	ZEB150-175	DILM185A(…)	ZEB225A-175	

DOL starter – modules PKMO, NZM, DILM and ZEB

4

Motor Data			Settings range		Basic device Motor-protective circuit breaker, circuit breaker
Motor rating	Rated operational current	Rated short-circuit current	Overload trigger	short-circuit release	
AC-3	AC-3				
380 V	380 V	380 V			
400 V	400 V	400 V			
415 V	415 V	415 V			
P	I_e	I_q	I_r	I_m	Type
kW	A	kA	A 	A 	

Modules PKMO, DILM and ZEB with and without reclose blocking

0.12	0.41	100	9.8	0.33 - 1.65	PKMO-0.63
0.18	0.6	100	9.8	0.33 - 1.65	PKMO-0.63
0.25	0.8	100	15.5	0.33 - 1.65	PKMO-1
0.37	1.1	100	24.8	0.33 - 1.65	PKMO-1.6
0.55	1.5	100	24.8	0.33 - 1.65	PKMO-1.6
0.75	1.9	100	38.8	1 - 5	PKMO-2.5
1.1	2.6	100	62	1 - 5	PKMO-4
1.5	3.6	100	62	1 - 5	PKMO-4

Modules NZM, DILM and ZEB with and without reclose blocking

0.37	1.1	100	320 - 560	1 - 5	NZMH1-S40
0.55	1.5	100	320 - 560	1 - 5	NZMH1-S40
0.75	1.9	100	320 - 560	1 - 5	NZMH1-S40
1.1	2.6	100	320 - 560	1 - 5	NZMH1-S40
1.5	3.6	100	320 - 560	1 - 5	NZMH1-S40
2.2	5	100	320 - 560	4 - 20	NZMH1-S40
3	6.6	100	320 - 560	4 - 20	NZMH1-S40
4	8.5	100	320 - 560	9 - 45	NZMH1-S40
5.5	11.3	100	320 - 560	9 - 45	NZMH1-S40
7.5	16	100	320 - 560	9 - 45	NZMH1-S40
11	21.7	100	320 - 560	9 - 45	NZMH1-S40
15	29.3	100	320 - 560	9 - 45	NZMH1-S40
18.5	36	100	320 - 560	9 - 45	NZMH1-S40
22	41	100	400 - 700	9 - 45	NZMH1-S50
30	55	100	504 - 882	20 - 100	NZMH1-S63
37	68	100	640 - 1120	20 - 100	NZMH1-S80
45	81	100	800 - 1250	20 - 100	NZMH1-S100
55	99	100	800 - 1250	20 - 100	NZMH1-S100
75	134	100	1280 - 2240	35 - 175	NZMH2-S160
90	161	100	1600 - 2500	35 - 175	NZMH2-S200

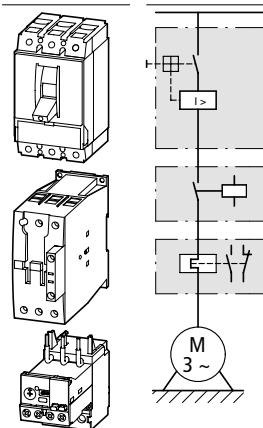
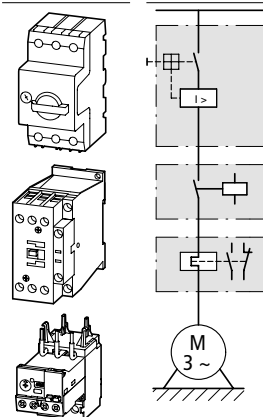

Contactor **Motor protection relay** **Contactor** **Motor protection relay** **Notes**
 Type of coordination "1" Type of coordination "1" Type of coordination "2" Type of coordination "2"

Type	Type	Type	Type	
DILM7-...(…)	ZEB12-1.65	DILM7-...(…)	ZEB12-1.65	The motor-starter combinations consist of the motor-protective circuit breaker or circuit breaker (without overload function), contactor and overload relay modules. They conform to IEC/EN 60947-4-1 or VDE 0660 Part 102. I_q = rated conditional short-circuit current
DILM7-...(…)	ZEB12-1.65	DILM7-...(…)	ZEB12-1.65	
DILM7-...(…)	ZEB12-1.65	DILM7-...(…)	ZEB12-1.65	
DILM7-...(…)	ZEB12-1.65	DILM7-...(…)	ZEB12-1.65	
DILM7-...(…)	ZEB12-1.65	DILM7-...(…)	ZEB12-1.65	
DILM7-...(…)	ZEB12-5	DILM7-...(…)	ZEB12-5	
DILM7-...(…)	ZEB12-5	DILM7-...(…)	ZEB12-5	
DILM7-...(…)	ZEB12-5	DILM7-...(…)	ZEB12-5	
				The combinations can be operated with or without reclose blocking. In the Manual position, the combination is blocked against automatic restarting. It must be reset locally. In the auto position, the combination automatically switches on again when the bimetallic elements have cooled down. Maximum trigger class: CLASS 10.
				Further information Technical data PKM0 → 3/48 Technical data NZM → Online catalog NZM accessories → Online catalog Accessories PKZ → 3/14 Technical data DILM → 1/114 DIL accessories → 1/64 Technical data ZEB → 2/26 Accessories ZEB → 2/18 Further actuating voltages → 1/83
DILM40(…)	ZEB32-5/KK	DILM40(…)	ZEB32-5/KK	
DILM40(…)	ZEB32-5/KK	DILM40(…)	ZEB32-5/KK	
DILM40(…)	ZEB32-5/KK	DILM40(…)	ZEB32-5/KK	
DILM40(…)	ZEB32-5/KK	DILM40(…)	ZEB32-5/KK	
DILM40(…)	ZEB32-5/KK	DILM40(…)	ZEB32-5/KK	
DILM40(…)	ZEB32-20/KK	DILM40(…)	ZEB32-20/KK	
DILM40(…)	ZEB32-20/KK	DILM40(…)	ZEB32-20/KK	
DILM40(…)	ZEB65-45	DILM40(…)	ZEB65-45	
DILM40(…)	ZEB65-45	DILM40(…)	ZEB65-45	
DILM40(…)	ZEB65-45	DILM40(…)	ZEB65-45	
DILM40(…)	ZEB65-45	DILM40(…)	ZEB65-45	
DILM40(…)	ZEB65-45	DILM40(…)	ZEB65-45	
DILM40(…)	ZEB65-45	DILM40(…)	ZEB65-45	
DILM50(…)	ZEB65-45	DILM50(…)	ZEB65-45	
DILM65(…)	ZEB65-100	DILM65(…)	ZEB65-100	
DILM80(…)	ZEB150-100	DILM80(…)	ZEB150-100	
DILM95(…)	ZEB150-100	DILM95(…)	ZEB150-100	
DILM115(…)	ZEB150-100	DILM115(…)	ZEB150-100	
DILM150(…)	ZEB150-175	DILM150(…)	ZEB150-175	
DILM170(…)	ZEB225A-175	DILM185A(…)	ZEB225A-175	

DOL starter – modules NZM, DILM and ZEB

4

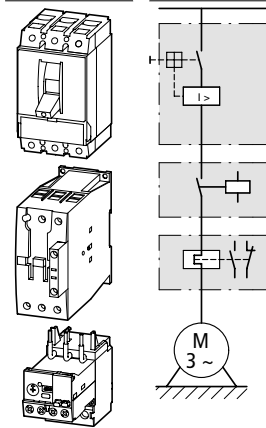

Motor Data				Settings range		Basic device Circuit breaker
Motor rating	Rated operational current		Rated short-circuit current	Overload trigger	short-circuit release	
AC-3	AC-3					
500 V 525 V	500 V	525 V	500 V 525 V			
P kW	I_e A	I_b A	I_q kA	I_r A	I_{rm} A	Type
Modules NZM, DILM and ZEB with and without reclose blocking						
1.1	2.1	1.7	50	1 - 5	320 - 560	NZMH2-S40
1.5	2.9	2.3	50	1 - 5	320 - 560	NZMH2-S40
2.2	4	3.2	50	1 - 5	320 - 560	NZMH2-S40
3	5.3	4.2	50	4 - 20	320 - 560	NZMH2-S40
4	6.8	5.4	50	4 - 20	320 - 560	NZMH2-S40
5.5	9	7.1	50	9 - 45	320 - 560	NZMH2-S40
7.5	12.1	9.6	50	9 - 45	320 - 560	NZMH2-S40
11	17.4	17	50	9 - 45	320 - 560	NZMH2-S40
15	23.4	22.5	50	9 - 45	320 - 560	NZMH2-S40
18.5	28.9	28	50	9 - 45	320 - 560	NZMH2-S40
22	33	32	50	9 - 45	320 - 560	NZMH2-S40
30	44	43	50	20 - 100	400 - 700	NZMH2-S50
37	54	54	50	20 - 100	504 - 882	NZMH2-S63
45	65	64	50	20 - 100	640 - 1120	NZMH2-S80
55	79	78	50	20 - 100	640 - 1120	NZMH2-S80
75	107	106	50	20 - 100	1000 - 1750	NZMH2-S125
90	129	127	50	35 - 175	1280 - 2240	NZMH2-S160
110	157	154	35	35 - 175	2000 - 3500	NZMH3-S250

Contactor Motor protection relay Contactor Motor protection relay **Notes**
 Type of coordination "1" Type of coordination "1" Type of coordination "2" Type of coordination "2"

Type	Type	Type	Type	
DILM40(...)	ZEB32-5/KK	DILM80(...)	ZEB32-5/KK	The motor starter combinations consist of the circuit breaker (without overload function), contactor and overload relay module. They conform to IEC/EN 60947-4-1 or VDE 0660 Part 102. I _q = rated conditional short-circuit current
DILM40(...)	ZEB32-5/KK	DILM80(...)	ZEB32-5/KK	
DILM40(...)	ZEB32-5/KK	DILM80(...)	ZEB32-5/KK	
DILM40(...)	ZEB32-20/KK	DILM80(...)	ZEB32-20/KK	The combinations can be operated with or without reclose blocking. In the Manual position, the combination is blocked against automatic restarting. It must be reset locally.
DILM40(...)	ZEB32-20/KK	DILM80(...)	ZEB32-20/KK	
DILM40(...)	ZEB65-45	DILM80(...)	ZEB32-45/KK	In the auto position, the combination automatically switches on again when the bimetallic elements have cooled down. Maximum trigger class: CLASS 10
DILM40(...)	ZEB65-45	DILM80(...)	ZEB32-45/KK	
DILM40(...)	ZEB65-45	DILM80(...)	ZEB32-45/KK	
DILM40(...)	ZEB65-45	DILM80(...)	ZEB150-100	Further information
DILM40(...)	ZEB65-45	DILM80(...)	ZEB150-100	
DILM40(...)	ZEB65-45	DILM80(...)	ZEB150-100	Technical data NZM
DILM80(...)	ZEB150-100	DILM80(...)	ZEB150-100	NZM accessories
DILM80(...)	ZEB150-100	DILM80(...)	ZEB150-100	Technical data DILM
DILM80(...)	ZEB150-100	DILM80(...)	ZEB150-100	DIL accessories
DILM80(...)	ZEB150-100	DILM80(...)	ZEB150-100	Technical data ZEB
DILM80(...)	ZEB150-100	DILM80(...)	ZEB150-100	Accessories ZEB
DILM115(...)	ZEB150-100	DILM115(...)	ZEB150-100	Further actuating voltages
DILM150(...)	ZEB150-175	DILM150(...)	ZEB150-175	
DILM185A/22(...)	ZEB225A-175	DILM185A/22(...)	ZEB225A-175	

Page
→ Online catalog
→ Online catalog
→ 1/114
→ 1/64
→ 2/26
→ 2/18
→ 1/84

Product selection

4

Motor Data Settings range Motor starter actuating voltage
230 V 50 Hz

Motor rating	Rated operational current	Rated conditional short-circuit current	Rated conditional short-circuit current	Overload trip	Short-circuit release	Type Article no.
AC-3	AC-3	380 - 415 V	380 - 415 V			
380 V 400 V 415 V	380 V 400 V 415 V	Type "1" coordination	Type "2" coordination			
P kW	I_e A	I_q kA	I_q kA	I_r A	I_{rm} A	

Complete devices MSC-R

0.06	0.21	150	50	0.16 - 0.25	3.9	MSC-R-0.25-M7(230V50HZ) 283171
0.09	0.31	150	50	0.25 - 0.4	6.2	MSC-R-0.4-M7(230V50HZ) 283172
0.12 0.18	0.41 0.6	150	50	0.4 - 0.63	9.8	MSC-R-0.63-M7(230V50HZ) 283173
0.25	0.8	150	50	0.63 - 1	15.5	MSC-R-1-M7(230V50HZ) 283175
0.37 0.55	1.1 1.5	150	50	1 - 1.6	24.8	MSC-R-1.6-M7(230V50HZ) 283176
0.75	1.9	150	50	1.6 - 2.5	38.8	MSC-R-2.5-M7(230V50HZ) 283178
1.1 1.5	2.6 3.6	150	50	2.5 - 4	62	MSC-R-4-M7(230V50HZ) 283179
2.2	5	150	50	4 - 6.3	97.7	MSC-R-6.3-M7(230V50HZ) 283181
3	6.6	150	–	6.3 - 10	155	MSC-R-10-M7(230V50HZ) 283182
4	8.5	150	–	6.3 - 10	155	MSC-R-10-M9(230V50HZ) 283183
5.5	11.3	50	–	8 - 12	186	MSC-R-12-M12(230V50HZ) 283184
3	6.6	50	50	6.3 - 10	155	MSC-R-10-M17(230V50HZ) 101049
4	11.3	50	50	8 - 12	186	MSC-R-12-M17(230V50HZ) 101050
7.5	15.2	50	50	10 - 16	248	MSC-R-16-M17(230V50HZ) 283186
11	21.7	50	50	20 - 25	388	MSC-R-25-M25(230V50HZ) 283187
15	29.3	50	50	25 - 32	496	MSC-R-32-M32(230V50HZ) 283188

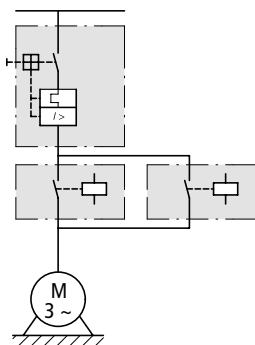
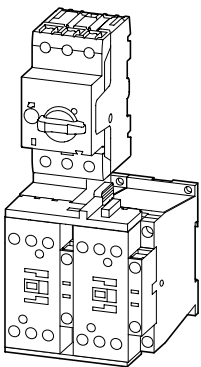
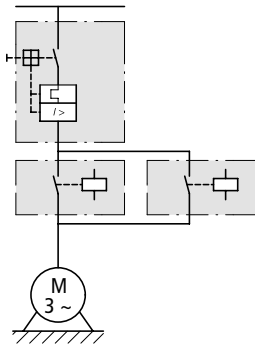
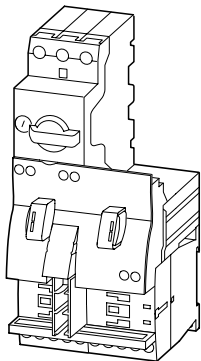

Motor starter actuating voltage 24 V DC	Std. pack	Motor-protective circuit breakers	Contactors	Reversing starter wiring set	Notes
Type Article no.				Mechanical link module and electric module and reversing link	

		Type	Type	Type	
MSC-R-0.25-M7(24VDC) 283190	1 pc. 	PKZM0-0.25	DILM7-01(...)	PKZM0-XRM12	
MSC-R-0.4-M7(24VDC) 283191		PKZM0-0.4	DILM7-01(...)	PKZM0-XRM12	Also suitable for motors with efficiency class IE3. IE3-ready devices are identified by the logo on their packaging.
MSC-R-0.63-M7(24VDC) 283192		PKZM0-0.63	DILM7-01(...)	PKZM0-XRM12	
MSC-R-1-M7(24VDC) 283194		PKZM0-1	DILM7-01(...)	PKZM0-XRM12	The reversing starters (complete devices) consist of a PKZM0 motor-protective circuit breaker and two DILM contactors.
MSC-R-1.6-M7(24VDC) 283195		PKZM0-1.6	DILM7-01(...)	PKZM0-XRM12	With the adapter-less top-hat rail mounting of starters up to 12 A, only the motor-protective circuit breaker on the top-hat rail requires an adapter. The contactors are provided with mechanical support via a mechanical connection element.
MSC-R-2.5-M7(24VDC) 283197		PKZM0-2.5	DILM7-01(...)	PKZM0-XRM12	
MSC-R-4-M7(24VDC) 283198		PKZM0-4	DILM7-01(...)	PKZM0-XRM12	Control wire guide with max. 6 conductors up to 2.5mm external diameter or 4 conductors up to 3.5mm external diameter.
MSC-R-6.3-M7(24VDC) 283200		PKZM0-6.3	DILM7-01(...)	PKZM0-XRM12	
MSC-R-10-M7(24VDC) 283201		PKZM0-10	DILM7-01(...)	PKZM0-XRM12	From 16 A, the motor-protective circuit breakers and contactors are mounted on the top-hat rail adapter plate.
MSC-R-10-M9(24VDC) 283202		PKZM0-10	DILM9-01(...)	PKZM0-XRM12	The connection of the main circuit between the motor-protective circuit breaker and the contactor is established using electric contact modules.
MSC-R-12-M12(24VDC) 283203		PKZM0-12	DILM12-01(...)	PKZM0-XRM12	Complete units with mechanical interlock, starters up to 12 A also feature electrical interlock.
					When using the auxiliary contact DILA-XHIT... (→ page 1/46) the plug-in electrical connector can be removed without the removal of the top mounting auxiliary contact. Cannot be combined with NHI-E-...-PKZ0-C standard auxiliary contact with spring-loaded terminal.
MSC-R-10-M17(24VDC) 101051	1 pc. 	PKZM0-10	DILM17-01(...)	PKZM0-XRM32	Further information
MSC-R-12-M17(24VDC) 101052		PKZM0-12	DILM17-01(...)	PKZM0-XRM32	Technical data PKZM0 → 3/48
MSC-R-16-M17(24VDC) 283204		PKZM0-16	DILM17-01(...)	PKZM0-XRM32	Accessories PKZ → 3/14
MSC-R-25-M25(24VDC) 283205		PKZM0-25	DILM25-01(...)	PKZM0-XRM32	Technical data DILM → 1/114
MSC-R-32-M32(24VDC) 283206		PKZM0-32	DILM32-01(...)	PKZM0-XRM32	DILM accessories → 1/64
					Further actuating voltages → 1/83

Information relevant for export to North America



Product standards	UL60947-4-1A; CSA-C22.2 No. 14-10; IEC60947-4-1; CE marking
UL File No.	E123500
UL CCN	NKJH
CSA File No.	12528
CSA Class No.	3211-24
NA Certification	UL listed, CSA certified

Module selection

4

Motor Data				Settings range	
Motor rating	Rated operational current	Rated short-circuit current		Overload trigger	Short-circuit release
	AC-3	380 - 415 V	380 - 415 V		
380 V 400 V 415 V	380 V 400 V 415 V	Type of coordination "1"	Type of coordination "2"		
P kW	I_e A	I_q kA	I_q kA	I_r A	I_m A

Modules PKZM0 and DILM

0.06	0.21	150	50	0.16 - 0.25	3.9
0.09	0.31	150	50	0.25 - 0.4	6.2
0.12	0.41	150	50	0.4 - 0.63	9.8
0.18	0.6	150	50	0.4 - 0.63	9.8
0.25	0.8	150	50	0.63 - 1	15.5
0.37	1.1	150	50	1 - 1.6	24.8
0.55	1.5	150	50	1 - 1.6	24.8
0.75	1.9	150	50	1.6 - 2.5	38.8
1.1	2.6	150	50	2.5 - 4	62
1.5	3.6	150	50	2.5 - 4	62
2.2	5	150	50	4 - 6.3	97.7
3	6.6	150	50	6.3 - 10	155
4	8.5	150	50	6.3 - 10	155
5.5	11.3	50	50	8 - 12	186
7.5	15.2	50	50	10 - 16	248
11	21.7	50	50	20 - 25	388
15	29.3	50	50	25 - 32	496

Modules PKZM4 and DILM

5.5	11.3	50	50	10 - 16	248
7.5	15.2	50	50	10 - 16	248
11	21.7	50	50	20 - 25	388
15	29.3	50	50	24 - 32	496
18.5	36	50	50	32 - 40	620
22	41	50	50	40 - 50	775
30	55	50	50	50 - 58	899
34	63	50	50	55 - 65	1008

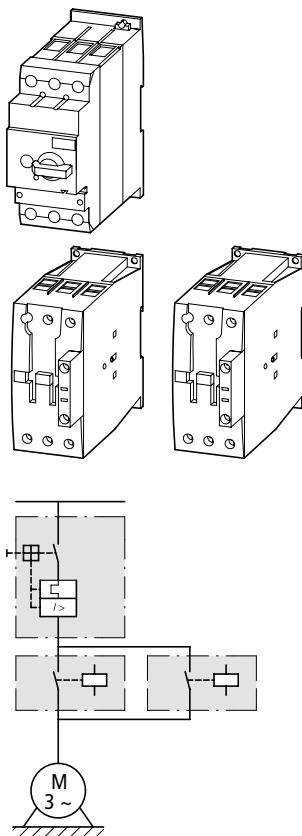
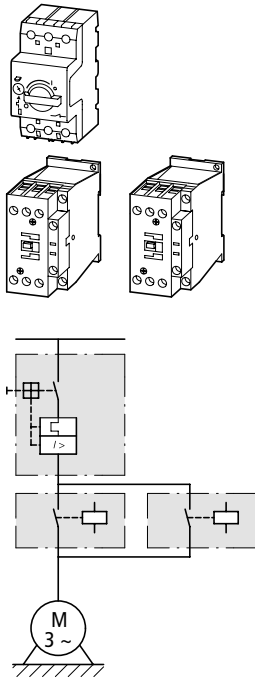

Motor protection switch	Contactor Type of coordination "1"	Contactor Type of coordination "2"	Notes
-------------------------	---------------------------------------	---------------------------------------	-------

Type	Type	Type	
PKZM0-0.25	2 x DILM7-...(…)	2 x DILM7-...(…)	The motor-starter combinations consist of a motor-protective circuit breaker module and a contactor module. They conform to IEC/EN 60947-4-1 or VDE 0660 Part 102. I _q = rated conditional short-circuit current Further information Technical data PKZM0 → 3/48 Accessories PKZ → 3/14 Technical data DILM → 1/114 DILM accessories → 1/64 Further actuating voltages → 1/83
PKZM0-0.4	2 x DILM7-...(…)	2 x DILM7-...(…)	
PKZM0-0.63	2 x DILM7-...(…)	2 x DILM7-...(…)	
PKZM0-0.63	2 x DILM7-...(…)	2 x DILM7-...(…)	
PKZM0-1	2 x DILM7-...(…)	2 x DILM7-...(…)	
PKZM0-1.6	2 x DILM7-...(…)	2 x DILM7-...(…)	
PKZM0-1.6	2 x DILM7-...(…)	2 x DILM7-...(…)	
PKZM0-2.5	2 x DILM7-...(…)	2 x DILM7-...(…)	
PKZM0-4	2 x DILM7-...(…)	2 x DILM7-...(…)	
PKZM0-4	2 x DILM7-...(…)	2 x DILM7-...(…)	
PKZM0-6.3	2 x DILM7-...(…)	2 x DILM7-...(…)	
PKZM0-10	2 x DILM9-...(…)	2 x DILM17-...(…)	
PKZM0-10	2 x DILM9-...(…)	2 x DILM17-...(…)	
PKZM0-12	2 x DILM12-...(…)	2 x DILM17-...(…)	
PKZM0-16	2 x DILM17-...(…)	2 x DILM17-...(…)	
PKZM0-25	2 x DILM25-...(…)	2 x DILM25-...(…)	
PKZM0-32	2 x DILM32-...(…)	2 x DILM32-...(…)	

PKZM4-16	2 x DILM17-...(…)	2 x DILM17-...(…)	The motor-starter combinations consist of a motor-protective circuit breaker module and a contactor module. They conform to IEC/EN 60947-4-1 or VDE 0660 Part 102. I _q = rated conditional short-circuit current Further information Technical data PKZM4 → 3/48 Accessories PKZ → 3/14 Technical data DILM → 1/114 DILM accessories → 1/64 Further actuating voltages → 1/84
PKZM4-16	2 x DILM17-...(…)	2 x DILM17-...(…)	
PKZM4-25	2 x DILM25-...(…)	2 x DILM25-...(…)	
PKZM4-32	2 x DILM32-...(…)	2 x DILM32-...(…)	
PKZM4-40	2 x DILM40(…)	2 x DILM40(…)	
PKZM4-50	2 x DILM50(…)	2 x DILM50(…)	
PKZM4-58	2 x DILM65(…)	2 x DILM65(…)	
PKZM4-63	2 x DILM65(…)	2 x DILM65(…)	

Reversing starter – modules NZM and DILM

4

Motor Data			Settings range	
Motor rating	Rated operational current	Rated conditional short-circuit current	Overload trigger	short-circuit release
AC-3	AC-3			
380 V	380 V	400 V		
400 V	400 V	415 V		
415 V	415 V			
P	I_e	I_q	I_r	I_{rm}
kW	A	kA	A	A

Modules NZMN and DILM

18.5	36	50	32 - 40	320 - 560
22	41	50	40 - 50	400 - 700
30	55	50	50 - 63	504 - 882
37	68	50	63 - 80	640 - 1120
45	81	50	80 - 100	800 - 1250
55	99	50	80 - 100	800 - 1250
75	134	50	125 - 160	1280 - 2240
90	161	50	160 - 200	1600 - 2500
110	196	50	160 - 200	1600 - 2500
132	231	50	175 - 350	350 - 4900
160	279	50	175 - 350	350 - 4900
200	349	50	175 - 350	350 - 4900
250	437	50	225 - 450	450 - 6300
315	544	50	275 - 550	550 - 7700
400	683	50	438 - 875	875 - 12250
450	750	50	438 - 875	875 - 12250
500	820	50	438 - 875	875 - 12250
560	947	50	700 - 1400	1400 - 19600

Modules NZMH and DILM

22	41	100	40 - 50	400 - 700
30	55	100	50 - 63	504 - 882
37	68	100	63 - 80	640 - 1120
55	81	100	80 - 100	800 - 1250
55	100	100	100 - 125	1000 - 1750
75	134	100	125 - 160	1280 - 2240
30	55	100	45 - 90	90 - 1260
37	68	100	45 - 90	90 - 1260
45	81	100	45 - 90	90 - 1260
55	100	100	70 - 140	140 - 1960
75	134	100	70 - 140	140 - 1960
90	161	100	110 - 120	220 - 3080
110	196	100	110 - 120	220 - 3080
132	231	100	175 - 350	350 - 4900
160	279	100	175 - 350	350 - 4900
200	349	100	175 - 350	350 - 4900

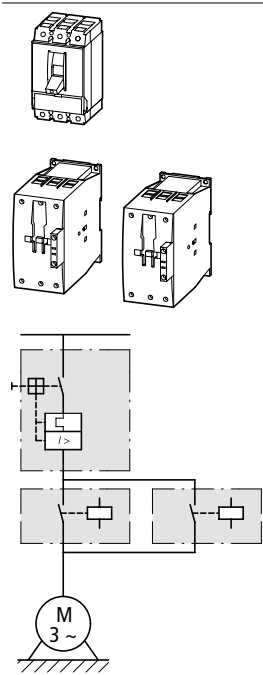
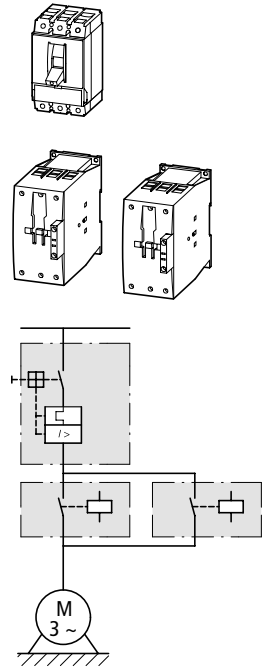

Circuit breaker	Contactor Type of coordination "1"	Contactor Type of coordination "2"	Notes
-----------------	---------------------------------------	---------------------------------------	-------

Type	Type	Type		
NZMN1-M40	2 x DILM40(...)	2 x DILM80(...)	The motor-starter combinations consist of a circuit breaker and a contactor module. They conform to IEC/EN 60947-4-1 or VDE 0660 Part 102. I_q = rated conditional short-circuit current	
NZMN1-M50	2 x DILM50(...)	2 x DILM80(...)		
NZMN1-M63	2 x DILM65(...)	2 x DILM80(...)		
NZMN1-M80	2 x DILM80(...)	2 x DILM80(...)		
NZMN1-M100	2 x DILM95(...)	2 x DILM95(...)		
NZMN1-M100	2 x DILM115(...)	2 x DILM115(...)		
NZMN2-M160	2 x DILM150(...)	2 x DILM150(...)		
NZMN2-M200	2 x DILM185A/22(...)	2 x DILM185A/22(...)		
NZMN2-M200	2 x DILM225A/22(...)	2 x DILM225A/22(...)		
NZMN3-ME350	2 x DILM250/22(...)	2 x DILM250/22(...)		
NZMN3-ME350	2 x DILM300A/22(...)	2 x DILM300A/22(...)	Further information Technical data NZM NZM accessories Technical data DILM DIL accessories Further actuating voltages	
NZMN3-ME350	2 x DILM400/22(...)	2 x DILM400/22(...)		
NZMN3-ME450	2 x DILM500/22(...)	2 x DILM500/22(...)		
NZMN4-ME550	2 x DILM580/22(...)	2 x –		
NZMN4-ME875	2 x DILM650/22(...)	2 x –		
NZMN4-ME875	2 x DILM750/22(...)	2 x –		
NZMN4-ME875	2 x DILM820/22(...)	2 x –		
NZMN4-ME1400	2 x DILM1000/22(...)	2 x –		
NZMH2-M50	2 x DILM80(...)	2 x DILM80(...)		The motor-starter combinations consist of a circuit breaker and a contactor module. They conform to IEC/EN 60947-4-1 or VDE 0660 Part 102. I_q = rated conditional short-circuit current
NZMH2-M63	2 x DILM80(...)	2 x DILM80(...)		
NZMH2-M80	2 x DILM80(...)	2 x DILM80(...)		
NZMH2-M100	2 x DILM95(...)	2 x DILM95(...)		
NZMH2-M125	2 x DILM115(...)	2 x DILM115(...)		
NZMH2-M160	2 x DILM150(...)	2 x DILM150(...)		
NZMH2-ME90	2 x DILM80(...)	2 x DILM80(...)		
NZMH2-ME90	2 x DILM80(...)	2 x DILM80(...)		
NZMH2-ME90	2 x DILM95(...)	2 x DILM95(...)		
NZMH2-ME140	2 x DILM115(...)	2 x DILM115(...)		
NZMH2-ME140	2 x DILM150(...)	2 x DILM150(...)	Further information Technical data NZM NZM accessories Technical data DILM DIL accessories Further actuating voltages	
NZMH2-ME220	2 x DILM185A/22(...)	2 x DILM185A/22(...)		
NZMH2-ME220	2 x DILM225A/22(...)	2 x DILM225A/22(...)		
NZMH3-ME350	2 x DILM250/22(...)	2 x DILM250/22(...)		
NZMH3-ME350	2 x DILM300A/22(...)	2 x DILM300A/22(...)		
NZMH3-ME350	2 x DILM400/22(...)	2 x DILM400/22(...)		

DOL starter on busbar adapter – complete devices MSC-D

Product selection

Motor Data				Settings range		Motor starter actuating voltage 230 V 50 Hz	Std. pack
Motor rating	Rated operational current	Rated short-circuit current		Overload trip	Short-circuit releases	Type Article no.	
AC-3	AC-3	380 - 415 V		380 - 415 V			
380 V	380 V	Type "1"	Type "2"				
400 V	400 V	coordination					
415 V	415 V						
P	I_e	I_q	I_q	I_r		I_{rm}	
kW	A	kA	kA	A		A	

Complete devices MSC-D on BBA

0.06	0.21	100	50	0.16 - 0.25	3.9	MSC-D-0.25-M7(230V50HZ)/BBA²⁾ 102737	1 pc.
0.09	0.31	100	50	0.25 - 0.4	6.2	MSC-D-0.4-M7(230V50HZ)/BBA²⁾ 102738	
0.12	0.41	100	50	0.4 - 0.63	9.8	MSC-D-0.63-M7(230V50HZ)/BBA²⁾ 102739	
0.18	0.6						
0.25	0.8	100	50	0.63 - 1	15.5	MSC-D-1-M7(230V50HZ)/BBA²⁾ 102950	
0.37	1.1	100	50	1 - 1.6	24.8	MSC-D-1.6-M7(230V50HZ)/BBA²⁾ 102951	
0.55	1.5						
0.75	1.9	100	50	1.6 - 2.5	38.8	MSC-D-2.5-M7(230V50HZ)/BBA²⁾ 102952	
1.1	2.6	100	50	2.5 - 4	62	MSC-D-4-M7(230V50HZ)/BBA²⁾ 102953	
1.5	3.6						
2.2	5	100	50	4 - 6.3	97.7	MSC-D-6.3-M7(230V50HZ)/BBA²⁾ 102954	
3	6.6	100	–	6.3 - 10	155	MSC-D-10-M7(230V50HZ)/BBA 102955	
4	8.5	100	–	6.3 - 10	155	MSC-D-10-M9(230V50HZ)/BBA 102956	
5.5	11.3	100	–	8 - 12	186	MSC-D-12-M12(230V50HZ)/BBA 102957	
7.5	15.2	50	–	10 - 16	248	MSC-D-16-M15(230V50HZ)/BBA¹⁾ 102958	
3	6.6	100	50	6.3 - 10	155	MSC-D-10-M17(230V50HZ)/BBA 102959	
4	8.5						
5.5	11.3	100	50	8 - 12	186	MSC-D-12-M17(230V50HZ)/BBA 102960	
7.5	15.2	50	50	10 - 16	248	MSC-D-16-M17(230V50HZ)/BBA¹⁾ 102961	
11	21.7	50	50	20 - 25	388	MSC-D-25-M25(230V50HZ)/BBA¹⁾ 102962	
15	29.3	50	50	25 - 32	496	MSC-D-32-M32(230V50HZ)/BBA¹⁾ 102963	

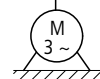
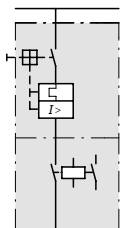
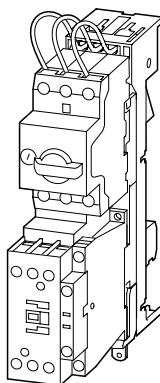
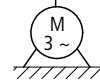
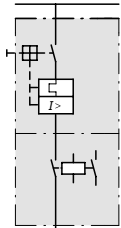
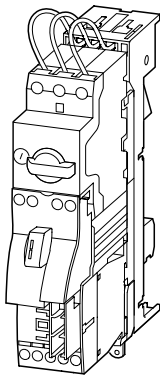



DOL starter on busbar adapter – complete devices MSC-D

Motor starter actuating voltage 24 V DC	Std. pack	Motor-protective circuit breakers	Contactors	DOL starter wiring set	Busbar adapter	Notes										
Type				Mechanical link module and electric contact module												
Article no.		Type	Type	Type	Type											
MSC-D-0.25-M7(24VDC)/BBA²⁾ 102964	1 pc. 	PKZM0-0.25	DILM7-10(...)	PKZM0-XDM12	BBA0-25											
MSC-D-0.4-M7(24VDC)/BBA²⁾ 102965		PKZM0-0.4	DILM7-10(...)	PKZM0-XDM12	BBA0-25	Also suitable for motors with efficiency class IE3. IE3-ready devices are identified by the logo on their packaging.										
MSC-D-0.63-M7(24VDC)/BBA²⁾ 102966		PKZM0-0.63	DILM7-10(...)	PKZM0-XDM12	BBA0-25											
MSC-D-1-M7(24VDC)/BBA²⁾ 102967		PKZM0-1	DILM7-10(...)	PKZM0-XDM12	BBA0-25	¹⁾ Not suitable for motors with efficiency class IE3.										
MSC-D-1.6-M7(24VDC)/BBA²⁾ 102968		PKZM0-1.6	DILM7-10(...)	PKZM0-XDM12	BBA0-25	The DOL starter (complete device) consists of a PKZM0 motor protective circuit breaker and a DILM contactor. These combinations are mounted on the busbar adapters.										
MSC-D-2.5-M7(24VDC)/BBA²⁾ 102969		PKZM0-2.5	DILM7-10(...)	PKZM0-XDM12	BBA0-25											
MSC-D-4-M7(24VDC)/BBA²⁾ 102970		PKZM0-4	DILM7-10(...)	PKZM0-XDM12	BBA0-25	The connection of the main circuit between the motor-protective circuit breaker and contactor is established with electric contact modules. Cannot be combined with NHI-E...-PKZ0-C standard auxiliary contact with spring-loaded terminals.										
MSC-D-6.3-M7(24VDC)/BBA 102971		PKZM0-6.3	DILM7-10(...)	PKZM0-XDM12	BBA0-25											
MSC-D-10-M7(24VDC)/BBA 102972		PKZM0-10	DILM7-10(...)	PKZM0-XDM12	BBA0-25	²⁾ Motor-starter combinations can be extended using extension terminal BK25/3-PKZ0-E and, if necessary, with three-phase commoning links B3.../...-PKZ0 for type F starters according to UL 508. Type F starter → page 4/42										
MSC-D-10-M9(24VDC)/BBA 102973		PKZM0-10	DILM9-10(...)	PKZM0-XDM12	BBA0-25											
MSC-D-12-M12(24VDC)/BBA 102974		PKZM0-12	DILM12-10(...)	PKZM0-XDM12	BBA0-25											
MSC-D-16-M15(24VDC)/BBA¹⁾ 102975		PKZM0-16	DILM15-10(...)	PKZM0-XDM12	BBA0-25	<table border="0"> <tr> <td>Further information</td> <td>Page</td> </tr> <tr> <td>Technical data PKZM0</td> <td>→ 3/48</td> </tr> <tr> <td>Accessories PKZ</td> <td>→ 3/14</td> </tr> <tr> <td>Technical data DILM</td> <td>→ 1/114</td> </tr> <tr> <td>DILM accessories</td> <td>→ 1/64</td> </tr> </table>	Further information	Page	Technical data PKZM0	→ 3/48	Accessories PKZ	→ 3/14	Technical data DILM	→ 1/114	DILM accessories	→ 1/64
Further information	Page															
Technical data PKZM0	→ 3/48															
Accessories PKZ	→ 3/14															
Technical data DILM	→ 1/114															
DILM accessories	→ 1/64															
MSC-D-10-M17(24VDC)/BBA 102976		PKZM0-10	DILM17-10(...)	PKZM0-XM32DE	BBA0-32	Information relevant for export to North America Product standards UL60947-4-1A; CSA-C22.2 No. 14-10; IEC60947-4-1; CE marking UL File No. E123500 UL CCN NKJH CSA File No. 12528 CSA Class No. 3211-04 NA Certification UL listed, CSA certified										
MSC-D-12-M17(24VDC)/BBA 102977		PKZM0-12	DILM17-10(...)	PKZM0-XM32DE	BBA0-32											
MSC-D-16-M17(24VDC)/BBA 102978		PKZM0-16	DILM17-10(...)	PKZM0-XM32DE	BBA0-32											
MSC-D-25-M25(24VDC)/BBA 102979		PKZM0-25	DILM25-10(...)	PKZM0-XM32DE	BBA0-32											
MSC-D-32-M32(24VDC)/BBA 102980		PKZM0-32	DILM32-10(...)	PKZM0-XM32DE	BBA0-32											

DOL starter on busbar adapter – complete devices MSC-DM

4

Motor Data				Settings range			Motor starter	Std. pack
Motor rating	Rated operational current	Rated short-circuit current		Overload trip	Short-circuit releases	Actuating voltage 230 V 50 Hz		
AC-3	AC-3	380 - 415 V	380 - 415 V			Type		
380 V	380 V	Type "1"	Type "2"			Article no.		
400 V	400 V	coordination	coordination					
415 V	415 V							
P	I_e	I_q	I_q	I_r		I_{rm}		
kW	A	kA	kA	A		A		
Complete devices MSC-DM on MSFA								
0.06	0.21	100	50	0.16 - 0.25	3.9	MSC-DM-0.25-M7(230V50HZ)/MSFA	1 pc.	
						191114		
0.09	0.31	100	50	0.25 - 0.4	6.2	MSC-DM-0.4-M7(230V50HZ)/MSFA		
						191115		
0.12	0.41	100	50	0.4 - 0.63	9.8	MSC-DM-0.63-M7(230V50HZ)/MSFA		
0.18	0.6					191116		
0.25	0.8	100	50	0.63 - 1	15.5	MSC-DM-1-M7(230V50HZ)/MSFA		
						191117		
0.37	1.1	100	50	1 - 1.6	24.8	MSC-DM-1.6-M7(230V50HZ)/MSFA		
0.55	1.5					191118		
0.75	1.9	100	50	1.6 - 2.5	38.8	MSC-DM-2.5-M7(230V50HZ)/MSFA		
						191119		
1.1	2.6	100	50	2.5 - 4	62	MSC-DM-4-M7(230V50HZ)/MSFA		
1.5	3.6					191120		
2.2	5	100	50	4 - 6.3	97.7	MSC-DM-6.3-M7(230V50HZ)/MSFA		
						191121		
3	6.6	100	–	6.3 - 10	155	MSC-DM-10-M7(230V50HZ)/MSFA		
						191122		
4	8.5	100	–	6.3 - 10	155	MSC-DM-10-M9(230V50HZ)/MSFA		
						191123		
5.5	11.3	100	–	8 - 12	186	MSC-DM-12-M12(230V50HZ)/MSFA		
						191124		
7.5	15.2	50	–	10 - 16	248	MSC-DM-16-M15(230V50HZ)/MSFA¹⁾		
						191125		

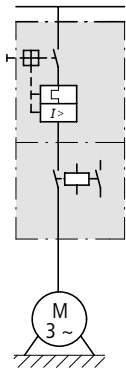
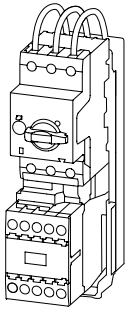

DOL starter on busbar adapter – complete devices MSC-DM

Motor starter Actuating voltage 24 V DC Type Article no.	Std. pack	Motor-protective circuit breakers	Contactor	DOL starter wiring set Mechanical link module and electric contact module	Busbar adapter	Notes										
		Type	Type	Type	Type											
MSC-DM-0.25-M7(24VDC)/MSFA 191102	1 pc.	PKZM0-0.25	DILM7-10(...)	PKZM0-XDM15ME	MSFAD-25											
MSC-DM-0.4-M7(24VDC)/MSFA 191103		PKZM0-0.4	DILM7-10(...)	PKZM0-XDM15ME	MSFAD-25											
MSC-DM-0.63-M7(24VDC)/MSFA 191104		PKZM0-0.63	DILM7-10(...)	PKZM0-XDM15ME	MSFAD-25	Also suitable for motors with efficiency class IE3. IE3-ready devices are identified by the logo on their packaging.										
MSC-DM-1-M7(24VDC)/MSFA 191105		PKZM0-1	DILM7-10(...)	PKZM0-XDM15ME	MSFAD-25	¹⁾ Not suitable for motors with efficiency class IE3.										
MSC-DM-1.6-M7(24VDC)/MSFA 191106		PKZM0-1.6	DILM7-10(...)	PKZM0-XDM15ME	MSFAD-25	The DOL starter (complete device) consists of a PKZM0 motor-protective circuit breaker and a DILM contactor. These combinations are mounted on the busbar adapters.										
MSC-DM-2.5-M7(24VDC)/MSFA 191107		PKZM0-2.5	DILM7-10(...)	PKZM0-XDM15ME	MSFAD-25											
MSC-DM-4-M7(24VDC)/MSFA 191108		PKZM0-4	DILM7-10(...)	PKZM0-XDM15ME	MSFAD-25	The connection of the main circuit between the motor-protective circuit breaker and contactor is established with electric contact modules.										
MSC-DM-6.3-M7(24VDC)/MSFA 191109		PKZM0-6.3	DILM7-10(...)	PKZM0-XDM15ME	MSFAD-25	<table border="0"> <tr> <td>Further information</td> <td>Page</td> </tr> <tr> <td>Technical data PKZM0</td> <td>→ 3/48</td> </tr> <tr> <td>Accessories PKZ</td> <td>→ 3/14</td> </tr> <tr> <td>Technical data DILM</td> <td>→ 1/114</td> </tr> <tr> <td>DILM accessories</td> <td>→ 1/64</td> </tr> </table>	Further information	Page	Technical data PKZM0	→ 3/48	Accessories PKZ	→ 3/14	Technical data DILM	→ 1/114	DILM accessories	→ 1/64
Further information	Page															
Technical data PKZM0	→ 3/48															
Accessories PKZ	→ 3/14															
Technical data DILM	→ 1/114															
DILM accessories	→ 1/64															
MSC-DM-10-M7(24VDC)/MSFA 191110		PKZM0-10	DILM7-10(...)	PKZM0-XDM15ME	MSFAD-25											
MSC-DM-10-M9(24VDC)/MSFA 191111		PKZM0-10	DILM9-10(...)	PKZM0-XDM15ME	MSFAD-25											
MSC-DM-12-M12(24VDC)/MSFA 191112		PKZM0-12	DILM12-10(...)	PKZM0-XDM15ME	MSFAD-25											
MSC-DM-16-M15(24VDC)/MSFA¹⁾ 191113		PKZM0-16	DILM15-10(...)	PKZM0-XDM15ME	MSFAD-25											

DOL starter on busbar adapter – complete devices MSC-R

Motor starter
Actuating voltage 230 V 50 Hz

Motor Data				Settings range		Type Article no.
Motor rating	Rated operational current	Rated conditional short-circuit current		Overload trip	Short-circuit releases	
AC-3	AC-3	380 - 415 V	380 - 415 V			
380 V	380 V	Type "1"	Type "2"			
400 V	400 V	coordination	coordination			
415 V	415 V					
P	I_e	I_q	I_q	I_r	I_{rm}	
kW	A	kA	kA	A	A	

Complete devices MSC-R on BBA

0.06	0.21	100	50	0.16 - 0.25	3.9	MSC-R-0.25-M7(230V50HZ)/BBA 102981
0.09	0.31	100	50	0.25 - 0.4	6.2	MSC-R-0.4-M7(230V50HZ)/BBA 102982
0.12	0.41	100	50	0.4 - 0.63	9.8	MSC-R-0.63-M7(230V50HZ)/BBA 102983
0.18	0.6					
0.25	0.8	100	50	0.63 - 1	15.5	MSC-R-1-M7(230V50HZ)/BBA 102984
0.37	1.1	100	50	1 - 1.6	24.8	MSC-R-1.6-M7(230V50HZ)/BBA 102985
0.55	1.5					
0.75	1.9	100	50	1.6 - 2.5	38.8	MSC-R-2.5-M7(230V50HZ)/BBA 102986
1.1	2.6	100	50	2.5 - 4	62	MSC-R-4-M7(230V50HZ)/BBA 102987
1.5	3.6					
2.2	5	100	50	4 - 6.3	97.7	MSC-R-6.3-M7(230V50HZ)/BBA 102988
3	6.6	100	–	6.3 - 10	155	MSC-R-10-M7(230V50HZ)/BBA 102989
4	8.5	100	–	6.3 - 10	155	MSC-R-10-M9(230V50HZ)/BBA 102990
5.5	11.3	100	–	8 - 12	186	MSC-R-12-M12(230V50HZ)/BBA 102991
3	6.6	100	50	6.3 - 10	155	MSC-R-10-M17(230V50HZ)/BBA 102992
4	8.5					
5.5	11.3	100	50	8 - 12	186	MSC-R-12-M17(230V50HZ)/BBA 102993
7.5	15.2	50	50	10 - 16	248	MSC-R-16-M17(230V50HZ)/BBA 102994
11	21.7	50	50	20 - 25	388	MSC-R-25-M25(230V50HZ)/BBA 102995
15	29.3	50	50	25 - 32	496	MSC-R-32-M32(230V50HZ)/BBA 102996

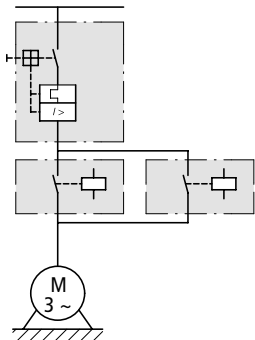
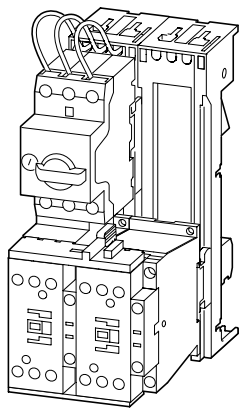
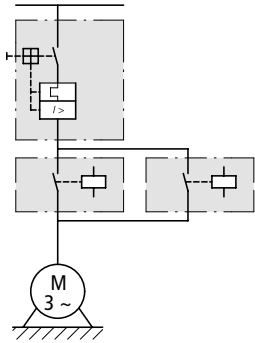
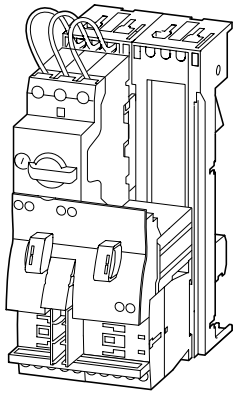

DOL starter on busbar adapter – complete devices MSC-R

Motor starter
Actuating voltage 24 V DC

Std. pack

Motor-protective
circuit breakers

Contactors

wiring set
Reversing starter

Busbar
adapter

Notes

Type
Article no.

Mechanical link
module and electric
contact module and
reversing link

Type	Type	Type	Type	Type	Type
MSC-R-0.25-M7(24VDC)/BBA 102997	1 pc. 	PKZM0-0.25	2 x DILM7-01(...)	PKZM0-XRM12	BBA0R-25
MSC-R-0.4-M7(24VDC)/BBA 102998		PKZM0-0.4	2 x DILM7-01(...)	PKZM0-XRM12	BBA0R-25
MSC-R-0.63-M7(24VDC)/BBA 102999		PKZM0-0.63	2 x DILM7-01(...)	PKZM0-XRM12	BBA0R-25
MSC-R-1-M7(24VDC)/BBA 103000		PKZM0-1	2 x DILM7-01(...)	PKZM0-XRM12	BBA0R-25
MSC-R-1.6-M7(24VDC)/BBA 103001		PKZM0-1.6	2 x DILM7-01(...)	PKZM0-XRM12	BBA0R-25
MSC-R-2.5-M7(24VDC)/BBA 103002		PKZM0-2.5	2 x DILM7-01(...)	PKZM0-XRM12	BBA0R-25
MSC-R-4-M7(24VDC)/BBA 103003		PKZM0-4	2 x DILM7-01(...)	PKZM0-XRM12	BBA0R-25
MSC-R-6.3-M7(24VDC)/BBA 103004		PKZM0-6.3	2 x DILM7-01(...)	PKZM0-XRM12	BBA0R-25
MSC-R-10-M7(24VDC)/BBA 103005		PKZM0-10	2 x DILM7-01(...)	PKZM0-XRM12	BBA0R-25
MSC-R-10-M9(24VDC)/BBA 103006		PKZM0-10	2 x DILM9-01(...)	PKZM0-XRM12	BBA0R-25
MSC-R-12-M12(24VDC)/BBA 103007		PKZM0-12	2 x DILM12-01(...)	PKZM0-XRM12	BBA0R-25
MSC-R-10-M17(24VDC)/BBA 103008		PKZM0-10	2 x DILM17-01(...)	PKZM0-XM32DE + DILM32-XRL	BBA0R-32
MSC-R-12-M17(24VDC)/BBA 103009		PKZM0-12	2 x DILM17-01(...)	PKZM0-XM32DE + DILM32-XRL	BBA0R-32
MSC-R-16-M17(24VDC)/BBA 103010		PKZM0-16	2 x DILM17-01(...)	PKZM0-XM32DE + DILM32-XRL	BBA0R-32
MSC-R-25-M25(24VDC)/BBA 103011		PKZM0-25	2 x DILM25-01(...)	PKZM0-XM32DE + DILM32-XRL	BBA0R-32
MSC-R-32-M32(24VDC)/BBA 103012		PKZM0-32	2 x DILM32-01(...)	PKZM0-XM32DE + DILM32-XRL	BBA0R-32



Also suitable for motors with efficiency class IE3. IE3-ready devices are identified by the logo on their packaging.

The reversing starters (complete devices) consist of a PKZM0 motor-protective circuit breaker and two DILM contactors. These combinations are mounted on the busbar adapters. The connection of the main circuit between the motor-protective circuit breaker and the contactor is established with electric contact modules. Complete device with mechanical interlock, starters up to 12 A also feature electrical interlock.

Further information	Page
Technical Data PKZM0	→ 3/48
Accessories PKZ	→ 3/14
Technical data DILM	→ 1/114
DILM accessories	→ 1/64

Information relevant for export to North America

Product standards	UL60947-4-1A; CSA-C22.2 No. 14-10; IEC60947-4-1; CE marking
UL File No.	E123500
UL CCN	NKJH
CSA File No.	12528
CSA Class No.	3211-04
NA Certification	UL listed, CSA certified

DOL starter type E – complete devices

4

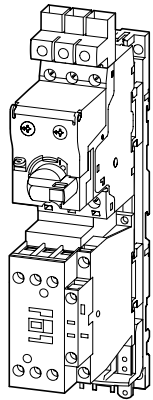

MSC-DE...

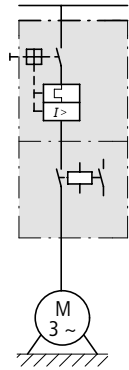

MSC-DEA...

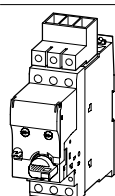
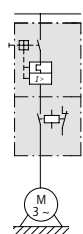

Maximum motor rating				Settings range		Short Circuit Current Rating			Type Article no.		
Three-phase current HP = PS				Overload trigger	short-circuit release						
200 V	230 V/	460 V	575 V	I_r		I_{rm}		240 V	480 Y/	600 Y/	Type Article no.
208 V	240 V	480 V	600 V								

Complete devices type E standard up to 32 A

Actuating voltage 110 V 50 Hz, 120 V 60 Hz

–	–	0.5	0.5	0.3 - 1.2	186	14	14	14	MSC-DE-1.2-M17-SP(110V50HZ,120V60HZ) 167802
0.75	0.75	2	–	1 - 4	186	18	18	–	MSC-DE-4-M17-SP(110V50HZ,120V60HZ) 167803
3	3	7.5	–	3 - 12	186	18	18	–	MSC-DE-12-M17-SP(110V50HZ,120V60HZ) 167804
5	7.5	15	–	8 - 32	496	18	18	–	MSC-DE-32-M32-SP(110V50HZ,120V60HZ) 167805

Actuating voltage 220 V 50 Hz, 240 V 60 Hz

–	–	0.5	0.5	0.3 - 1.2	186	14	14	14	MSC-DE-1.2-M17-SP(220V50HZ,240V60HZ) 167806
0.75	0.75	2	–	1 - 4	186	18	18	–	MSC-DE-4-M17-SP(220V50HZ,240V60HZ) 167807
3	3	7.5	–	3 - 12	186	18	18	–	MSC-DE-12-M17-SP(220V50HZ,240V60HZ) 167808
5	7.5	15	–	8 - 32	496	18	18	–	MSC-DE-32-M32-SP(220V50HZ,240V60HZ) 167809

Actuating voltage 230 V 50 Hz, 240 V 60 Hz

–	–	0.5	0.5	0.3 - 1.2	186	14	14	14	MSC-DE-1.2-M17-SP(230V50HZ,240V60HZ) 167810
0.75	0.75	2	–	1 - 4	186	18	18	–	MSC-DE-4-M17-SP(230V50HZ,240V60HZ) 167811
3	3	7.5	–	3 - 12	186	18	18	–	MSC-DE-12-M17-SP(230V50HZ,240V60HZ) 167812
5	7.5	15	–	8 - 32	496	18	18	–	MSC-DE-32-M32-SP(230V50HZ,240V60HZ) 167813

Actuating voltage 24 V 50/60 Hz

–	–	0.5	0.5	0.3 - 1.2	186	14	14	14	MSC-DE-1.2-M17-SP(24V50/60HZ) 167814
0.75	0.75	2	–	1 - 4	186	18	18	–	MSC-DE-4-M17-SP(24V50/60HZ) 167815
3	3	7.5	–	3 - 12	186	18	18	–	MSC-DE-12-M17-SP(24V50/60HZ) 167816
5	7.5	15	–	8 - 32	496	18	18	–	MSC-DE-32-M32-SP(24V50/60HZ) 167817

Actuating voltage 24 V DC

–	–	0.5	0.5	0.3 - 1.2	186	14	14	14	MSC-DE-1.2-M17-SP(24VDC) 167818
0.75	7.5	2	–	1 - 4	186	18	18	–	MSC-DE-4-M17-SP(24VDC) 167819
3	3	7.5	–	3 - 12	186	18	18	–	MSC-DE-12-M17-SP(24VDC) 167820
5	7.5	15	–	8 - 32	496	18	18	–	MSC-DE-32-M32-SP(24VDC) 167821

Complete devices type E extended up to 32 A





Actuating voltage 24 V DC

–	–	0.5	0.5	0.3 - 1.2	186	14	14	14	MSC-DEA-1.2-M17-SP(24VDC) 167822	
0.75	0.75	2	–	1 - 4	186	18	18	–	MSC-DEA-4-M17-SP(24VDC) 167823	
3	3	7.5	–	3 - 12	186	18	18	–	MSC-DEA-12-M17-SP(24VDC) 167824	
5	7.5	15	–	8 - 32	496	18	18	–	MSC-DEA-32-M32-SP(24VDC) 167825	

in conjunction with SmartWire-DT module → page 3/24

Complete devices type E standard up to 65 A (without contactor)

7.5	7.5	20	25	8 - 32	448	65	65	25	PKE65/AK/XTUW-32-SP 170483
15	15	40	–	16 - 65	910	65	65	–	PKE65/AK/XTU-65-SP 170482

Motor-protective circuit breakers	Contactors	DOL starter wiring set	Connection clamp	Std. pack	Notes
Type	Type	Type			
PKE12/XTU-1.2	DILM17-10(...)	PKZM0-XDM32	BK25/3-PKZ0-E	1 pc. 	The DOL starters type E (complete devices) consist of a PKE motor-protective circuit breaker with AK-PKZ0, a DILM contactor and an extension terminal BK25/3-PKZ0-E. Motor-protective circuit breaker and contactor mounted on top hat rail adapter plate. The connection of the main circuit between the motor-protective circuit breaker and the contactor is established with electric contact modules.
PKE12/XTU-4	DILM17-10(...)	PKZM0-XDM32	BK25/3-PKZ0-E		
PKE12/XTU-12	DILM17-10(...)	PKZM0-XDM32	BK25/3-PKZ0-E		
PKE32/XTU-32	DILM32-10(...)	PKZM0-XDM32	BK25/3-PKZ0-E		
Information relevant for export to North America					
					
PKE12/XTU-1.2	DILM17-10(...)	PKZM0-XDM32	BK25/3-PKZ0-E		Product standards UL60947-4-1A; CSA-C22.2 No. 14-10; IEC60947-4-1; CE marking E123500 UL File No. UL CCN NKJH CSA File No. 12528 CSA Class No. 3211-08 NA Certification UL listed, CSA certified Specially designed for NA
PKE12/XTU-4	DILM17-10(...)	PKZM0-XDM32	BK25/3-PKZ0-E		
PKE12/XTU-12	DILM17-10(...)	PKZM0-XDM32	BK25/3-PKZ0-E		
PKE32/XTU-32	DILM32-10(...)	PKZM0-XDM32	BK25/3-PKZ0-E		
PKE12/XTU-1.2	DILM17-10(...)	PKZM0-XDM32	BK25/3-PKZ0-E		
PKE12/XTU-4	DILM17-10(...)	PKZM0-XDM32	BK25/3-PKZ0-E		
PKE12/XTU-12	DILM17-10(...)	PKZM0-XDM32	BK25/3-PKZ0-E		
PKE32/XTU-32	DILM32-10(...)	PKZM0-XDM32	BK25/3-PKZ0-E		
PKE12/XTU-1.2	DILM17-10(...)	PKZM0-XDM32	BK25/3-PKZ0-E		
PKE12/XTU-4	DILM17-10(...)	PKZM0-XDM32	BK25/3-PKZ0-E		
PKE12/XTU-12	DILM17-10(...)	PKZM0-XDM32	BK25/3-PKZ0-E		
PKE32/XTU-32	DILM32-10(...)	PKZM0-XDM32	BK25/3-PKZ0-E		
PKE12/XTU-1.2	DILM17-10(...)	PKZM0-XDM32	BK25/3-PKZ0-E		
PKE12/XTU-4	DILM17-10(...)	PKZM0-XDM32	BK25/3-PKZ0-E		
PKE12/XTU-12	DILM17-10(...)	PKZM0-XDM32	BK25/3-PKZ0-E		
PKE32/XTU-32	DILM32-10(...)	PKZM0-XDM32	BK25/3-PKZ0-E		
PKE12/XTU-1.2	DILM17-01(...)	PKZM0-XDM32	BK25/3-PKZ0-E	1 pc. 	The DOL starters type E (complete devices) consist of a PKE motor-protective circuit breaker with AK-PKZ0, a DILM contactor and an extension terminal BK25/3-PKZ0-E. Motor-protective circuit breaker and contactor mounted on top hat rail adapter plate. The connection of the main circuit between the motor-protective circuit breaker and the contactor is established with electric contact modules. The MSC-DEA... DOL starters are prepared for communication via SmartWire-DT. For this, the PKE-SWD-32 communication module must be added.
PKE12/XTU-4	DILM17-01(...)	PKZM0-XDM32	BK25/3-PKZ0-E		
PKE12/XTU-12	DILM17-01(...)	PKZM0-XDM32	BK25/3-PKZ0-E		
PKE32/XTU-32	DILM32-01(...)	PKZM0-XDM32	BK25/3-PKZ0-E		
PKE65/AK/XTUW-32			BK50/3-PKZ4-E	1 pc. 	The type E starters consist of a PKE65 motor-protective circuit breaker with AK-PKZ0 and a BK50/3-PKZ4-E extension terminal.
PKE65/AK/XTU-65			BK50/3-PKZ4-E		

Type E starter combinations PKZM, DILM, BK

Maximum motor output HP = PS	Maximum rated motor current	Motor current setting range	Short Circuit Current Rating (SCCR)	Extension terminal or terminal cover	Motor protective circuit breaker	Contactor
460 V	FLA, 460 V		480 Y/277 V			
HP	A	A	kA			
PKZM0, DILM, BK modules						
–	0.16	0.1 – 0.16	65	BK25/3-PKZ0-E	PKZM0-0.16	DILM7 – DILM15
–	0.25	0.16 – 0.25	65	BK25/3-PKZ0-E	PKZM0-0.25	DILM7 – DILM15
–	0.40	0.25 - 0.40	65	BK25/3-PKZ0-E	PKZM0-0.4	DILM7 – DILM15
–	0.63	0.40 - 0.63	65	BK25/3-PKZ0-E	PKZM0-0.63	DILM7 – DILM15
–	1.0	0.63 - 1.0	65	BK25/3-PKZ0-E	PKZM0-1	DILM7 – DILM15
¾	1.6	1.0 – 1.6	65	BK25/3-PKZ0-E	PKZM0-1.6	DILM7 – DILM15
1	2.5	1.6 - 2.5	65	BK25/3-PKZ0-E	PKZM0-2.5	DILM7 – DILM15
2	4.0	2.5 – 4.0	65	BK25/3-PKZ0-E	PKZM0-4	DILM7 – DILM15
3	6.3	4.0 – 6.3	65	BK25/3-PKZ0-E	PKZM0-6.3	DILM17 – DILM32
7½	10	6.3 - 10	65	BK25/3-PKZ0-E	PKZM0-10	DILM17 – DILM32
7½	12	8.0 - 12	65	BK25/3-PKZ0-E	PKZM0-12	DILM17 – DILM32
10	16	10.0 - 16	65	BK25/3-PKZ0-E	PKZM0-16	DILM17 – DILM32
PKZM4, DILM, BK or HB modules						
10	16	10 - 16	65	BK50/3-PKZ4-E HB-PKZ4	PKZM4-16	DILM40 – DILM65
15	25	16 - 25	65	BK50/3-PKZ4-E HB-PKZ4	PKZM4-25	DILM40 – DILM65
20	32	24 - 32	65	BK50/3-PKZ4-E HB-PKZ4	PKZM4-32	DILM40 – DILM65
30	40	32 - 40	65	BK50/3-PKZ4-E HB-PKZ4	PKZM4-40	DILM40 – DILM65
30	50	40 - 50	65	BK50/3-PKZ4-E HB-PKZ4	PKZM4-50	DILM50 – DILM65
40	52	50 - 52	65	BK50/3-PKZ4-E HB-PKZ4	PKZM4-58	DILM65

Motor-starter combination for North America

Rating data for approved types ¹⁾				Maximum rated motor current A	Contactor Type	Motor protection relay Type	Maximum short-circuit protective device for North America	
Maximum motor rating Alternating current HP = PS							Fuse CEC or NEC A	Circuit breaker Continuous current A
200 V 208 V	230 V 240 V	460 V 480 V	575 V 600 V					
HP	HP	HP	HP					
Module DIL, Z								
–	–	½	½	1	DILEM-...(...)	ZE-1.0	3	15
–	–	¾	1	1.4	DILEM-...(...)	ZE-1.6	6	15
½	½	1	1½	2.3	DILEM-...(...)	ZE-2.4	6	15
¾	1	2	3	3.9	DILEM-...(...)	ZE-4	15	15
1½	1½	3	–	6	DILEM-...(...)	ZE-6	20	15
2	2	5	5	7.8	DILEM-...(...)	ZE-9	35	15
2	3	5	5	9.6	DILEM-...(...)	ZE-12	45	–
–	–	½	½	1	DILM7...(...)	ZB12-1	3	25
–	–	¾	1	1.4	DILM7...(...)	ZB12-1.6	6	25
½	½	1	1½	2.3	DILM7...(...)	ZB12-2.4	6	25
1	1	2	3	3.9	DILM7...(...)	ZB12-4	15	25
1½	½	3	–	6	DILM7...(...)	ZB12-6	20	25
2	3	5	7½	9	DILM9...(...)	ZB12-10	25	25
2	3	5	7½	9.6	DILM12...(...)	ZB12-10	25	25
3	3	7½	10	11	DILM12...(...)	ZB12-12	45	25
3	5	10	10	15.2	DILM15...(...)	ZB12-16	60	40
–	–	½	½	1	DILM17...(...)	ZB32-1	3	25
–	–	¾	1	1.4	DILM17...(...)	ZB32-1.6	6	25
½	½	1	1½	2.3	DILM17...(...)	ZB32-2.4	6	25
1	1	2	3	3.9	DILM17...(...)	ZB32-4	15	25
½	1½	3	–	6	DILM17...(...)	ZB32-6	20	25
2	3	5	7½	9.6	DILM17...(...)	ZB32-10	25	25
3	5	10	10	15.2	DILM17...(...)	ZB32-16	40	30
5	7½	15	20	22	DILM25...(...)	ZB32-24	90	100
10	10	20	25	32.2	DILM32...(...)	ZB32-32	125	125
2	3	5	7½	9.6	DILM40(...)	ZB65-10	40	40
3	5	10	10	15.2	DILM40(...)	ZB65-16	60	60
5	7½	20	25	32.2	DILM40(...)	ZB65-24	90	90
10	10	20	30	34	DILM40(...)	ZB65-40	125	125
15	20	40	50	54	DILM50(...)	ZB65-57	200	150
20	20	50	50	63	DILM65(...)	ZB65-65	200	160
20	25	50	60	68	DILM80(...)	ZB150-70	250	250
25	30	75	100	99	DILM95(...)	ZB150-100	400	400
40	40	100	100	124	DILM115(...)	ZB150-125	500	500
40	60	125	125	156	DILM150(...)	ZB150-150	600	600
50	60	125	150	156	DILM185A/22(...)	Z5-160/FF225A	600 Class J	600
60	75	150	200	192	DILM225A/22(...)	Z5-220/FF225A	800 Class J	800
75	100	200	250	248	DILM250/22(...)	Z5-250/FF250	700 Class J	600
100	125	250	300	312	DILM300A/22(...)	ZW7-400	1000	1000
125	150	300	400	382	DILM400/22(...)	ZW7-400	1000	1000
150	200	400	500	480	DILM500/22(...)	ZW7-540	1000	600

Notes¹⁾ Devices for world markets IEC ≙ UL/CSA

Motor-starter combination for North America

Rating data for approved types				Settings range			Circuit breaker	Contactor	Overload relay	Minimum enclosure volumes			
Maximum motor rating				Maximum rated motor current	Short Circuit Current Rating (SCCR)			Overload trip	Short-circuit release				
Alternating current HP = PS					480 V	600 V / 347 V ¹⁾	600 V						
200 V	230 V	460 V	575 V	A	kA	kA	kA	A	A	Type	Type	Type	cm ³
208 V	240 V	480 V	600 V										

HP	HP	HP	HP	A	kA	kA	kA	I_r	I_m	Type	Type	Type	cm ³
----	----	----	----	---	----	----	----	-------	-------	------	------	------	-----------------

NZMH...-S...-CNA, DILM, Z modules

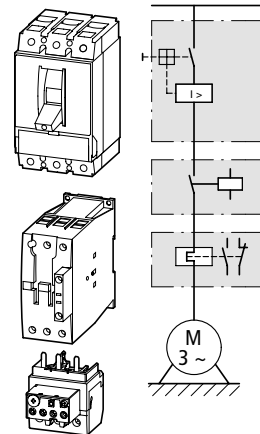

-	-	-	1/2	0.9	100	50	-	0.6 - 1	12.8 - 22.5	NZMH2-S1.6-CNA	DILM17-...(...)	ZB32-1	81.5
-	-	1/2	3/4	1.3	100	50	-	1 - 1.6	12.8 - 22.5	NZMH2-S1.6-CNA	DILM17-...(...)	ZB32-1.6	81.5
-	-	3/4	-	1.6	100	50	-	1 - 1.6	19.2 - 33.6	NZMH2-S2.4-CNA	DILM17-...(...)	ZB32-1.6	81.5
-	-	1	1	2.1	100	50	-	1.6 - 2.4	19.2 - 33.6	NZMH2-S2.4-CNA	DILM17-...(...)	ZB32-2.4	81.5
-	1/2	-	1 1/2	2.4	100	50	-	1.6 - 2.4	32 - 56	NZMH2-S5-CNA	DILM17-...(...)	ZB32-2.4	81.5
3/4	3/4	2	3	3.9	100	50	-	2.4 - 4	32 - 56	NZMH2-S5-CNA	DILM17-...(...)	ZB32-4	81.5
-	1	-	-	4.2	100	50	-	4 - 6	32 - 56	NZMH2-S5-CNA	DILM17-...(...)	ZB32-6	81.5
1	1 1/2	3	-	6	100	50	-	4 - 6	48 - 84	NZMH2-S8-CNA	DILM17-...(...)	ZB32-6	81.5
1 1/2	2	-	5	6.9	100	50	-	6 - 10	48 - 84	NZMH2-S8-CNA	DILM17-...(...)	ZB32-10	81.5
2	3	5	7 1/2	9.6	100	50	-	6 - 10	80 - 140	NZMH2-S12-CNA	DILM17-...(...)	ZB32-10	81.5
3	5	10	10	15.2	100	50	-	10 - 16	128 - 224	NZMH2-S18-CNA	DILM17-...(...)	ZB32-16	81.5
5	-	-	15	17.5	100	50	-	16 - 24	200 - 350	NZMH2-S26-CNA	DILM17-...(...)	ZB32-24	81.5
-	7 1/2	15	20	22	100	50	-	16 - 24	200 - 350	NZMH2-S26-CNA	DILM25-...(...)	ZB32-24	81.5
7 1/2	-	-	-	25.3	100	50	-	24 - 32	256 - 448	NZMH2-S33-CNA	DILM25-...(...)	ZB32-32	81.5
-	10	20	25	28	100	50	-	24 - 32	256 - 448	NZMH2-S33-CNA	DILM32-...(...)	ZB32-32	81.5
10	-	-	-	32.2	100	50	-	24 - 32	320 - 560	NZMH2-S40-CNA	DILM32-...(...)	ZB32-32	81.5
-	-	25	30	34	100	50	-	32 - 40	320 - 560	NZMH2-S40-CNA	DILM40(...)	ZB65-40	81.5
-	-	30	-	40	100	50	-	32 - 40	400 - 700	NZMH2-S50-CNA	DILM40(...)	ZB65-40	81.5
-	15	-	40	42	100	50	-	40 - 57	400 - 700	NZMH2-S50-CNA	DILM40(...)	ZB65-57	81.5
15	20	40	50	54	100	50	-	40 - 57	504 - 882	NZMH2-S63-CNA	DILM50(...)	ZB65-57	81.5
20	-	50	60	65	100	50	-	57 - 65	640 - 1120	NZMH2-S80-CNA	DILM65(...)	ZB65-65	81.5
-	25	-	-	68	100	50	-	50 - 70	640 - 1120	NZMH2-S80-CNA	DILM80(...)	ZB150-70	163
25	30	60	75	80	100	50	-	70 - 100	800 - 1400	NZMH2-S100-CNA	DILM80(...)	ZB150-100	163
-	40	75	100	104	100	50	-	70 - 100	1000 - 1750	NZMH2-S125-CNA	DILM95(...)	ZB150-100	163
30	-	-	-	92	100	50	-	70 - 100	1000 - 1750	NZMH2-S125-CNA	DILM115(...)	ZB150-100	163
40	-	100	125	125	100	50	-	100 - 125	1280 - 2240	NZMH2-S160-CNA	DILM115(...)	ZB150-125	163
-	50	-	-	130	100	50	-	125 - 150	1280 - 2240	NZMH2-S160-CNA	DILM115(...)	ZB150-150	163
-	-	125	-	156	100	50	-	125 - 150	1600 - 2500	NZMH2-S200-CNA	DILM150(...)	ZB150-150	265
50	60	-	150	154	100	50	-	120 - 160	1600 - 2500	NZMH2-S200-CNA	DILM185A/22(...)	Z5-160/FF250A	265
60	75	150	200	192	100	50	-	160 - 220	220 - 3080	NZMH2-SE220-CNA	DILM225A/22(...)	Z5-220/FF250A	265
75	100	200	250	248	100	50	50	160 - 220	350 - 4900	NZMH3-SE350-CNA	DILM250/22(...)	Z5-220/FF250	306
100	-	-	300	289	100	50	50	190 - 290	350 - 4900	NZMH3-SE350-CNA	DILM300/22(...)	ZW7-290	306
-	125	250	-	302	100	50	50	270 - 400	450 - 6300	NZMH3-SE450-CNA	DILM300A/22(...)	ZW7-400	306
125	150	300	400	382	100	50	50	270 - 400	450 - 6300	NZMH3-SE450-CNA	DILM400/22(...)	ZW7-400	306

Notes

¹⁾ Suitable for networks with earthed star-point

Technical data

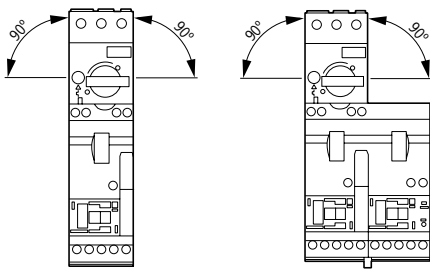
General	Standards	IEC/EN 60947-4-1, VDE 0660 UL 508, CSA 22.2 No.14 (see order pages)
	Mounting position	
Further technical data	Motor-protective circuit breaker PKZM0, PKE	→ page 3/48
	DILM contactors	→ page 1/114

Dimensions

Direct starter

MSC-D-...-M7... – MSC-D-...-M15...

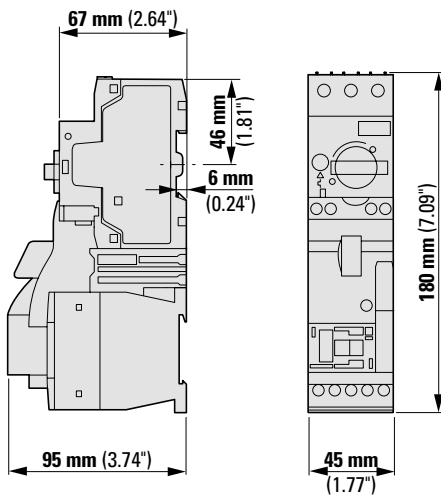

MSC-DE(A)-...-M7... – MSC-DE(A)-...-M12...

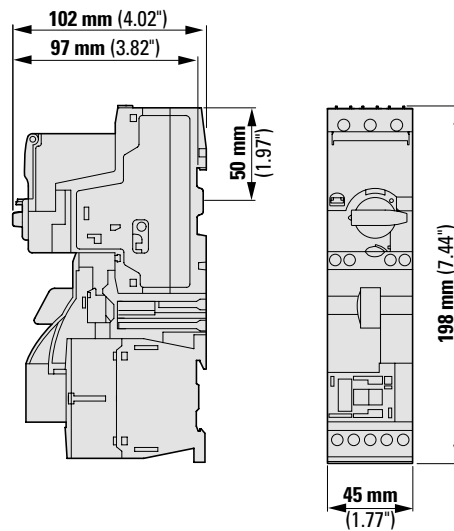

MSC-DM-...M7... – MSC-DM-...M15...

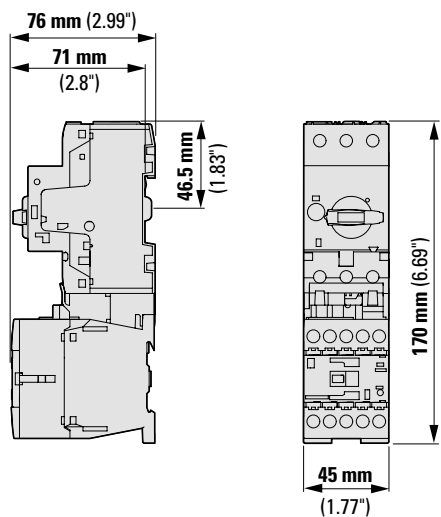

MSC-DM-...M17... – MSC-DM-...M32...

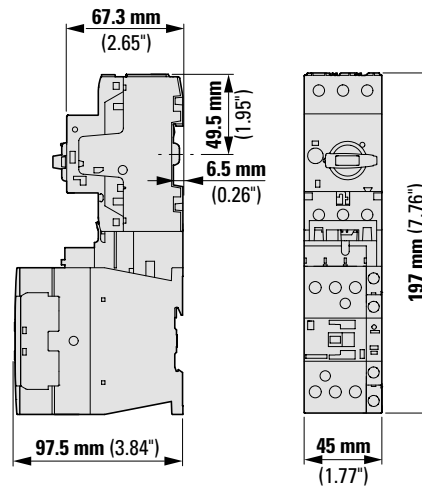

Direct starter

MSC-DME(A)-...-M17... – MSC-DME(A)-...-M32...

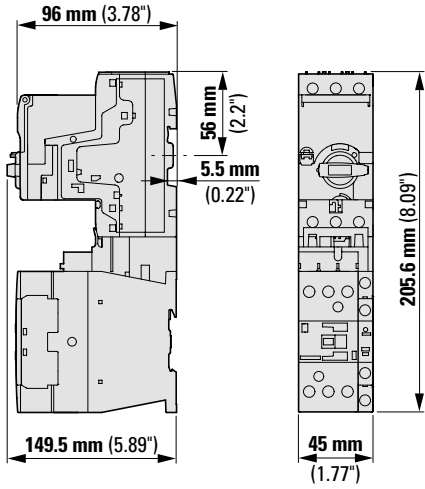

4

Reversing starter

MSC-R-...-M7..... – MSC-R-...-M12...

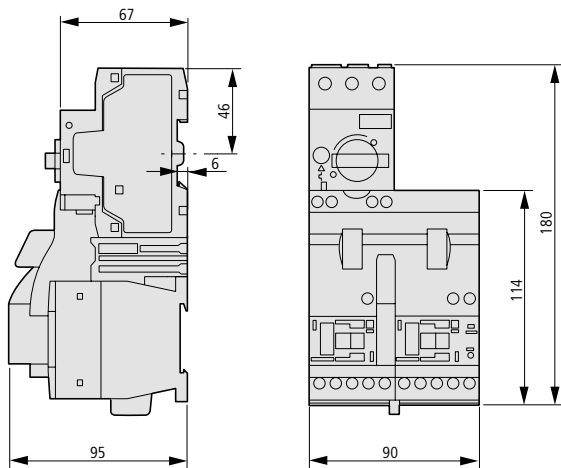

MSC-R-...-M17..... – MSC-R-...-M32...

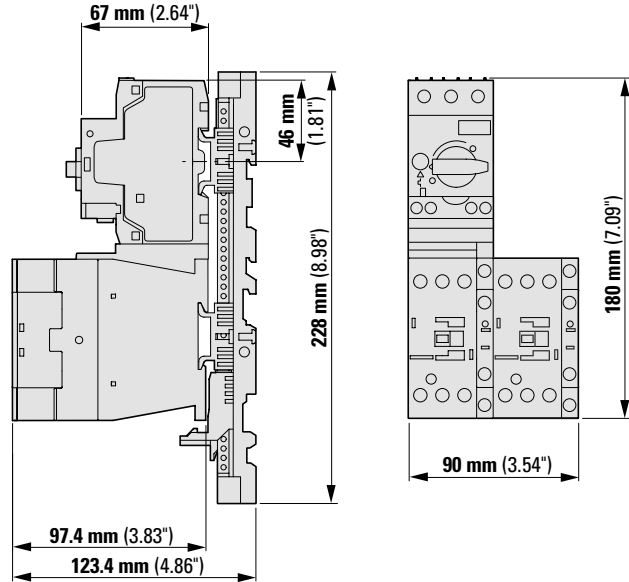

DOL starter on BBA

MSC-D-...-M7BBA... – MSC-D-...-M15BBA...

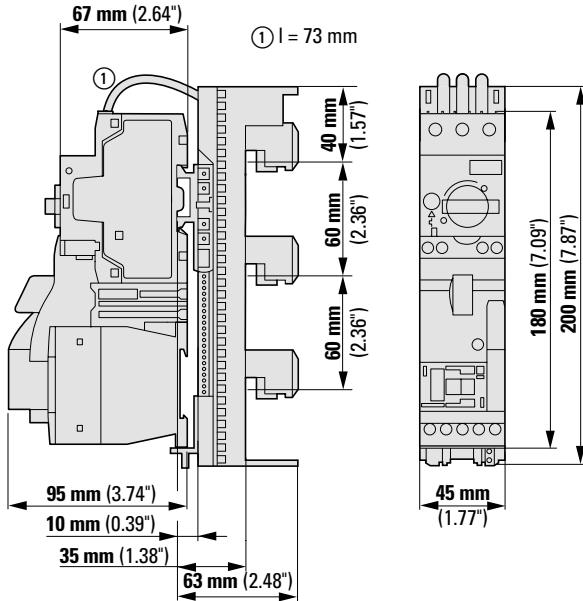

MSC-D-...-M17BBA... – MSC-D-...-M32BBA...

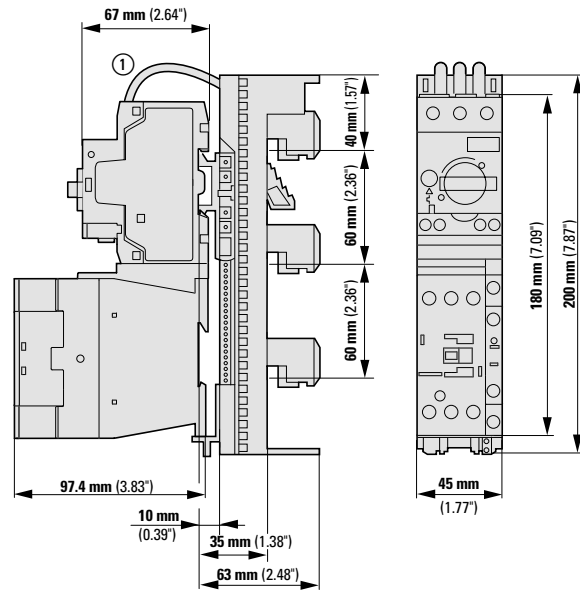

Reversing starter on BBA

MSC-R-...-M7BBA... – MSC-R-...-M12BBA...

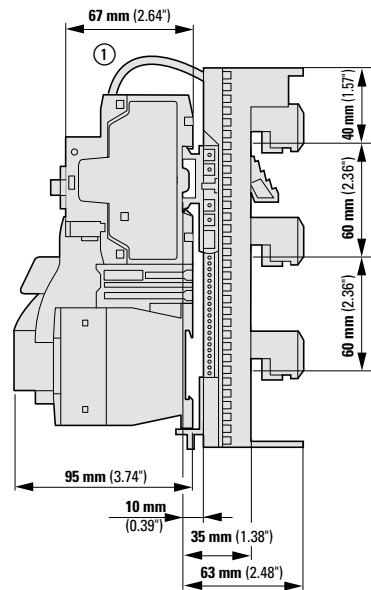

MSC-R-...-M17BBA... – MSC-R-...-M32BBA...

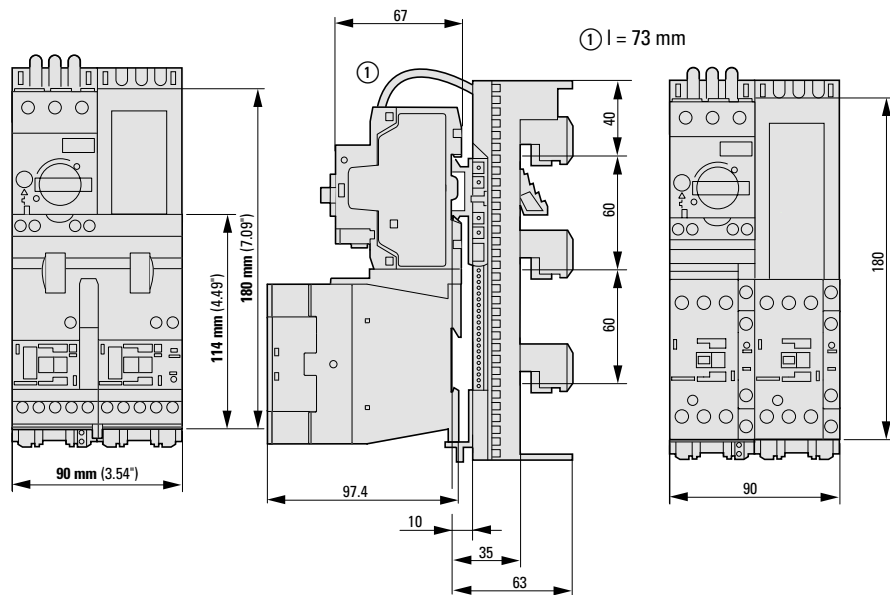

DOL starter on MSFA

MSC-DM-...-M7MSFA – MSC-DM-...-M15MSFA

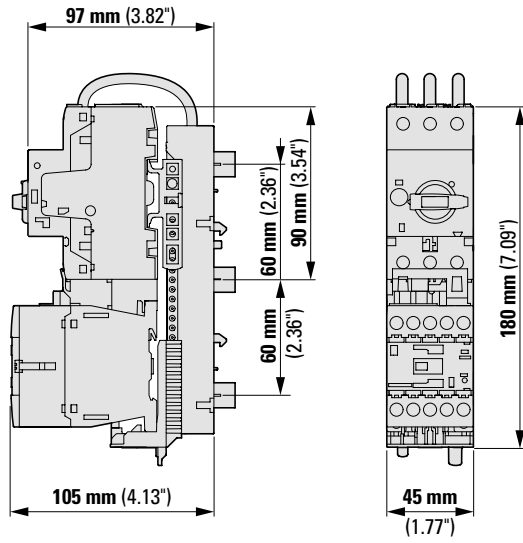

① I = 73 mm

Direct-on-line starter Type E

MSC-DE(A)-...-M17-SP... – MSC-DE(A)-...-M32-SP...

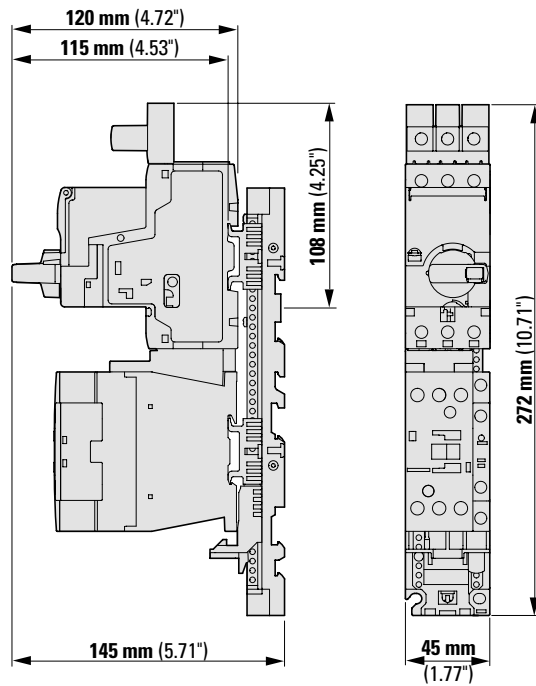

Starter type E PKE 65 without contactor

PKE65/AK/XTU

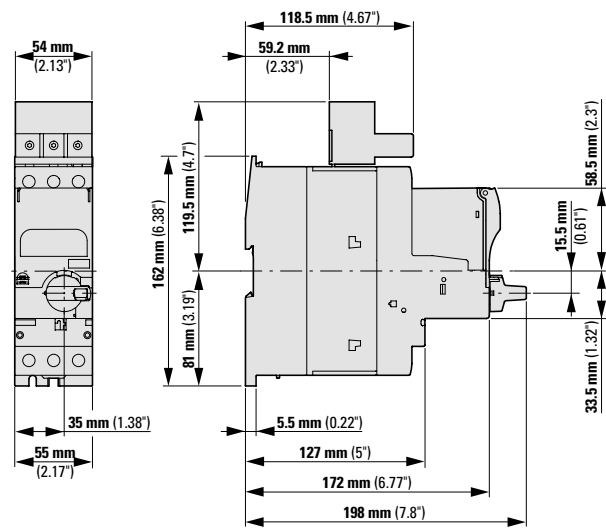

Build it in.

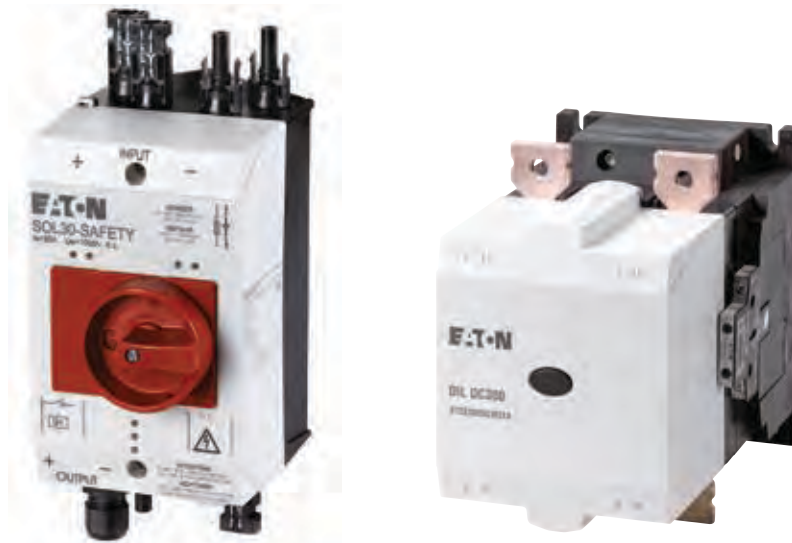

Fireman's switch and DC contactors: Safety and efficiency for DC applications

SOL30-SAFETY fireman's switch

When a solar installation burns, the solar modules and the DC cables are under DC voltage of up to 1000 V, with up to 8 A per line - even after isolation of the inverter. At a reasonable cost, the SOL30-SAFETY fireman's switch enables the disconnection of the voltage of the cables between the solar modules and the inverter – and therefore facilitates fire fighting without an electrical hazard.

DILDC contactors

Thanks to the proven hybrid technology of the DILDC contactors, a six-times greater lifespan is achieved in comparison with similar devices. The very short arcing times bring about less wear on the operating contacts. The DILDC contactors also enable a fast, simple and space-saving installation in the control panel.

PKZ-SOL



5.0 DC switching device, network and system protection	
5.1 Description	5/2
P-SOL, PKZ-SOL, SOL photo voltaic applications	5/2
5.2 Product selection	5/3
DILDC DC contactors, DC switch-disconnectors SOL (ready to install)	5/3
Fireman’s switch SOL30...-SAFETY	5/4
PV breaker M22-SOL, NAS network and system protection	5/5
P-SOL, PKZ-SOL DC switchgear, undervoltage release P-SOL-XUV	5/6
5.3 Engineering	5/7
DC switch-disconnectors SOL, P-SOL, DC string circuit-breaker	
PKZ-SOL- switchings	5/7
DC switchgear PKZ-SOL, SOL30(X...)-Safety, P-SOL-XUV- characteristics	5/8
5.4 Technical Data	5/9
DILDC DC contactors	5/9
SOL, P-SOL DC switch-disconnectors	5/12
Fireman’s switch SOL30...-SAFETY, undervoltage release P-SOL-XUV	5/13
NAS network and system protection	5/14
DC string circuit-breaker PKZ-SOL	5/15
5.5 Dimensions	5/16
DILDC contactors, fireman’s switch SOL30...-SAFETY	5/16
NAS network and system protection, DC switchgear P-SOL, PKZ-SOL, SOL20, SOL30	5/17

Product features - DIL DC contactors

DC contactors are suitable for many applications:

- Solar system
- Rail transport
- Marine & Offshore
- Energy storage
- Automotive infrastructure
- DC networks

Features

- Rated operating voltage: 1000 V DC
- Utilization category: DC-1
- Ambient temperature: -40 °C to +70 °C
- Electrical lifespan 0.15 x 10⁶ operations

P-SOL, PKZ-SOL, SOL photo voltaic applications

Description

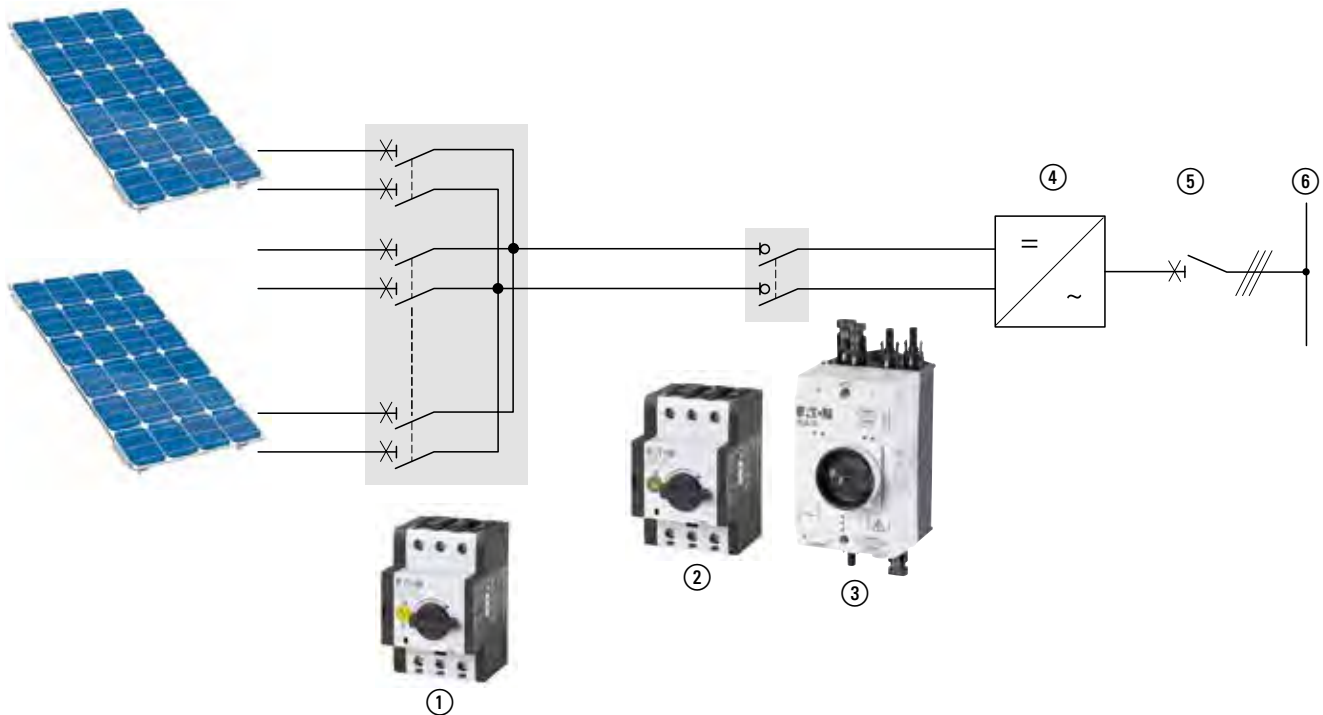

Photo voltaic systems

- ① DC String circuit-breaker PKZ-SOL
- ② DC switch-disconnector P-SOL
- ③ Ready to install SOL DC switch-disconnectors
- ④ Inverter
- ⑤ AC main switch
- ⑥ Mains

These photo voltaic systems can be independent from the power grid or can be connected to it. Photo voltaic systems that are connected to the grid feed the generated power directly into the power network. This eliminates the need for temporary storage. These systems consist of solar cells, one or more inverters, and a protective device for automatic cutoff in the event of a grid fault. Because of this, photo voltaic systems that are connected to the grid require extremely reliable and safe individual components.

Fireman's switch

- DC switch-disconnectors that isolate the cables between the solar modules and power inverters.
- They enable fire fighting without an electrical hazard.
- In addition to the **SOL30-Safety** for small installations, Eaton offers prefabricated fireman's switches housing 2, 3, 4 or 6 switch-disconnectors in a common enclosure.
- The individual lines can be separately fed into the inverter.

- This allows the use of several MPP trackers and helps optimize the inverter's performance.

Central network and system protection (NAS) in accordance with VDE-AR-N 4105 with contactors for the performance range from 30 to 100 kVA

- Undervoltage/Overvoltage monitoring
- Underfrequency/Overfrequency monitoring
- Monitoring the voltage quality (10-minute mean value)
- Vector shift monitoring connectible
- Single-fault proof
- Self-test
- Default in accordance with VDE-AR-N 4105, changes to the values are possible
- Alarm counter, alarm total time
- Sealing possibility and code protection
- Total switch-off time < 150 ms
- Low internal consumption
- Type-tested
- For all network configurations

DC string circuit breaker

- Protecting PV modules from fault currents, preventing e.g. In larger-scale systems, the recovery of intake modules on a module with short-circuit.
- After tripping and after the trip cause has been fixed, they are ready for operation.
- Open and designed for installation in customized generator terminal boxes.
- Tripping currents are adjustable within a wide range of limits.
- When installed in an enclosure, suitable for voltages of up to 900 V DC.

DC switch-disconnector

- Required, according to standard VDE 0100-712 (June 2006), between the PV module and inverter.
- Enclosed and open (after installation in enclosure) switch-disconnectors for voltages of up to 1000 V DC.
- Can be used as separate switching points, as required in VDI guideline VDI 6012, e.g. for the completely safe voltage-free switching of a faulty inverter.
- 2-pole switching – making it suitable for non-earthed systems too.
- TÜV-certified.
- **Open P-SOL switch-disconnectors** are intended for customized enclosures or inverters.
- Separate rotary handles and shaft extensions enable a flexible installation.
- An auxiliary contact block for indicating the switch state can be attached.

- A shunt release or undervoltage release is available for remote tripping.
- **SOL switch-disconnectors** in the enclosure are ready to install. Variants for 2 and 4 lines and for the common connector forms MC4 or metric screwing enable a problem-free integration in various systems.
- The enclosure in the degree of protection IP65 also enables an external assembly.
- The lockability offers security in the event of an emergency.
- A pressure equalization element prevents collection of condensation and thus malfunctions due to voltage flashovers.

General

- Optional shunt releases A-PKZ0 and undervoltage releases U-PKZ0 enable remote shutdown, e.g. for the fire department.
- Optional auxiliary contact NHI-E-PKZ0 signals the switch state.

DILDC DC contactors, DC switch-disconnectors SOL (ready to install)

Product Selection

Rated operational current	Auxiliary contact	Type Article no.	Std. pack
DC-1			
1000 V DC			
60 °C, open	N/O = normally open N/C = normally closed contact		
I_e			
A			

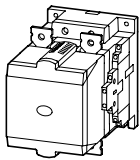

Comfort devices greater than 170 A

AC and DC operation
Actuating voltage: RDS 250 (110 - 250 V 40 - 60 Hz/110 - 350 V DC)
2-pole
Screw connection

300	2 N/O	2 N/C	DILDC300/22(RDS250) 183314	1 pc
400			DILDC400/22(RDS250) 186872	
500			DILDC500/22(RDS250) 186873	
600			DILDC600/22(RDS250) 183315	

Notes

Side mounting auxiliary contact

2 x DILM820-XHI11(V)-SI
2 x DILM820-XHI11-SA

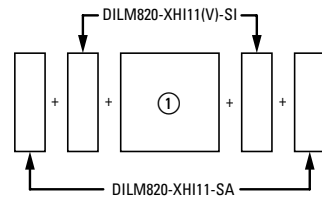

Accessories

Auxiliary contact modules

Information relevant for export to North America



Product standards IEC/EN 60947-4-1; UL508; CSA-C22.2 No. 14-05;
CE marking
UL File No. E338590
UL CCN NRNT
CSA File No. 012528
CSA Class No. C321124
NA Certification UL listed, CSA certified

Page

→ 1/48

Inputs	Outputs	max. Rated operational current	Type Article no.	Std. pack
Number of Strings	Connection type	DC-21A		
	Number of Strings	I_e		
	Connection type	A		

DC switch-disconnector, ready-to-install

Rated operating voltage $U_e = 1000$ V DC
Protection type IP65
Protection class 2
2-pole



2	MC4	1	MC4	20	SOL20/2MC4 120915	1 pc
4	MC4	1	MC4	20	SOL20/4MC4 120916	
2	MC4	1	MC4	30	SOL30/2MC4 120922	
4	MC4	1	MC4	30	SOL30/4MC4 120923	
2	Screwing M12	1	Screwing M16	20	SOL20/2MV 120919	
2	Screwing M12	1	Screwing M16	30	SOL30/2MV 120926	

Fireman's switch SOL30...-SAFETY

Inputs		Outputs		Type Article no.	Std. pack
Number of Strings	Connection type	Number of Strings	Connection type		

Fireman's switch

Possible applications: Residential and functional buildings
 Application range: DC isolation in photo voltaic systems between PV generator and inverter for disconnecting power.
 Rated operating voltage: $U_e = 1000 \text{ V DC}$
 Rated operational current at DC-21A = 30 A
 Prewired ready for connection
 Protection type IP65
 Remote tripping with integrated undervoltage release at 230 V, 50 Hz.
 Undervoltage release reacts with a 0.6-second delay in order to bridge network fluctuations quickly.
 Feedback of the switch state by means of the auxiliary contact.
 1 N/O and 1 N/C contact



2	MC4	1	MC4	SOL30-SAFETY/2MC4-U(230V50HZ) 144122	1 pc
---	-----	---	-----	--	------



2	Threaded connection M12	1	Threaded connection M12	SOL30-SAFETY/2MV-U(230V50HZ) 144123	
---	-------------------------	---	-------------------------	---	--

2	Threaded connection M12	1	Threaded connection M12	SOL30-SAFETY/2MV-U(24VDC) 172945	
---	-------------------------	---	-------------------------	--	--

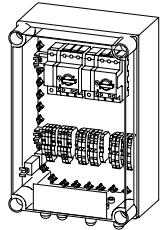

2	MC4	2	MC4	SOL30X2-SAFETY-MC4-U(230V50HZ) 168098	
---	-----	---	-----	---	--

2	Threaded connection M12	2	Threaded connection M12	SOL30X2-SAFETY-MV-U(230V50HZ) 168099	
---	-------------------------	---	-------------------------	--	--

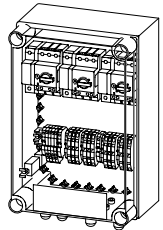

3	MC4	3	MC4	SOL30X3-SAFETY-MC4-U(230V50HZ) 168100	
---	-----	---	-----	---	--

3	Threaded connection M12	3	Threaded connection M12	SOL30X3-SAFETY-MV-U(230V50HZ) 168101	
---	-------------------------	---	-------------------------	--	--

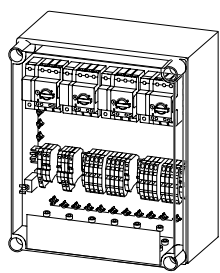

4	MC4	4	MC4	SOL30X4-SAFETY-MC4-U(230V50HZ) 168102	
---	-----	---	-----	---	--

4	Threaded connection M12	4	Threaded connection M12	SOL30X4-SAFETY-MV-U(230V50HZ) 168103	
---	-------------------------	---	-------------------------	--	--

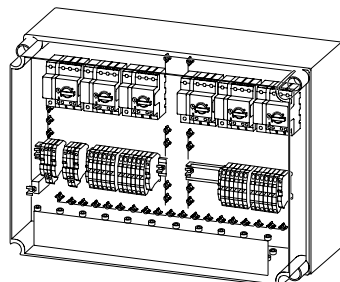

6	MC4	6	MC4	SOL30X6-SAFETY-MC4-U(230V50HZ) 168104	
---	-----	---	-----	---	--





6	Threaded connection M12	6	Threaded connection M12	SOL30X6-SAFETY-MV-U(230V50HZ) 168105	
---	-------------------------	---	-------------------------	--	--

PV breaker M22-SOL, NAS network and system protection

Motor rating	Type Article no.	Std. pack
AC-1		
400 V		
P		
kVA		

PV off switch

For remote switch-off of the fireman's switch SOL30...-SAFETY
 Complete unit
 Protection type IP65
 Tamper-proof according to ISO 13850/EN 418
 Color of enclosure top part: red

		With guard-ring, unlock by turning 1 N/C and 1 N/O	–	M22-SOL-PVT45PMP111Q 150644	1 pc
		with guard-ring, unlock by turning 2 N/C	–	M22-SOL-PVT45PMP102Q 150645	
		sealable, unlock by pulling 1 N/C and 1 N/O	–	M22-SOL-PVLP11-230Q 152627	

Device combinations for network and system protection

Central mains and system protection
 NA protection to VDE-AR-N 4105
 Protection type IP65
 4-pole
 Screw terminals

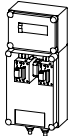
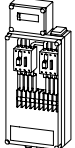
		43	NAS63-CI-1 168106	1 pc
		55	NAS80-CI-1 168107	
		86	NAS125-CI-1-K95 168110	
		100	NAS160-CI-1-K95 168111	

P-SOL, PKZ-SOL DC switchgear, undervoltage release P-SOL-XUV

5

max. Rated operational current DC-21A	permissible short-circuit current the solar modules	Type Article no.	Std. pack
I_e A	I_{sc} A		

DC switch-disconnector, open

Rated operating voltage $U_e = 1000$ V DC
Protection class II
2-pole

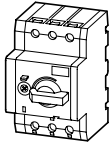

20	–	P-SOL20 120934	1 pc  
30	–	P-SOL30 120935	

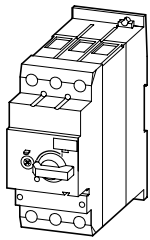

63	–	P-SOL60 120936	
----	---	--------------------------	--

DC string circuit-breaker, open

Rated operating voltage $U_e = 900$ V DC
Protection class II
2-pole

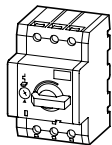

12	5 - 9	PKZ-SOL12 120937	1 pc
20	9 - 15	PKZ-SOL20 120938	
30	15 - 22	PKZ-SOL30 120939	

Notes

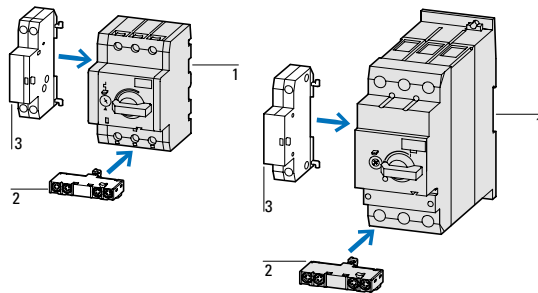

Accessories

- 1 auxiliary contacts NHI-E
- 2 shunt releases A-PKZ0
- 3 undervoltage releases U-PKZ0

Page

- 3/14
- 3/40
- 3/40

Information relevant for export to North America



Product standards: UL 508; CSA-C22.2 No. 14-10; IEC60439-1; CE marking
UL File No. E338590
UL CCN NRNT2
CSA File No. 165628
CSA Class No. 3211-05
Suitable for: UL recognized, CSA certified
SCCR: 10 kA (600 V DC, 70 A max. fuse)

for use with

Type Article no.

Std. pack

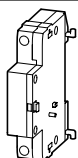

Undervoltage release

With internal delay for bridging intermittent voltage dips and fluctuations
Screw terminals

PKZM0, PKZM4, PKZM0-T, PKM0, PKZM01, PKE, P-SOL, PKZ-SOL	P-SOL-XUV(230V50/60HZ,240V50/60HZ) 157859	2 pcs.
	P-SOL-XUV(110V50/60HZ,120V50/60HZ) 157860	
	P-SOL-XUV(24VDC) 157861	

DC switch-disconnectors SOL, P-SOL, DC string circuit-breaker PKZ-SOL - switchings

Engineering

P-SOL and PKZ-SOL wiring

Switch-disconnector P-SOL

Non-earthed mains

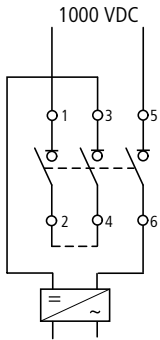

Earthed mains

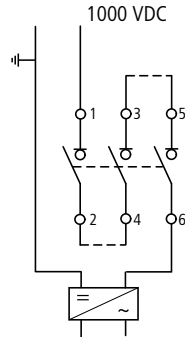

String circuit-breakers PKZ-SOL

Non-earthed mains

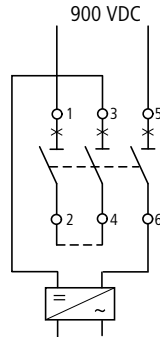

Earthed mains

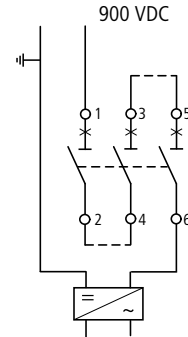

5

SOL internal circuit

SOL20/2MC4
SOL30/2MC4

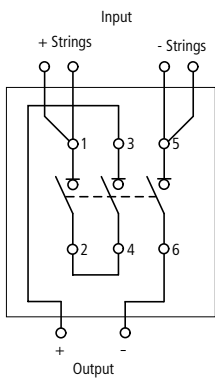

SOL20/2MV
SOL30/2MV

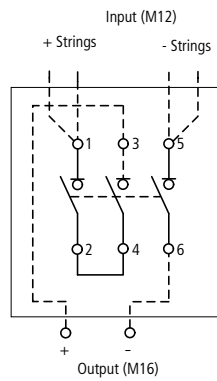

SOL20/4MC4
SOL30/4MC4

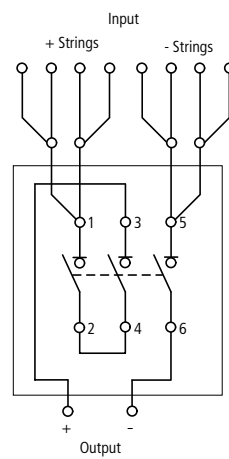

Characteristic curves

Tripping characteristic curve
DC String circuit-breaker PKZ-SOL

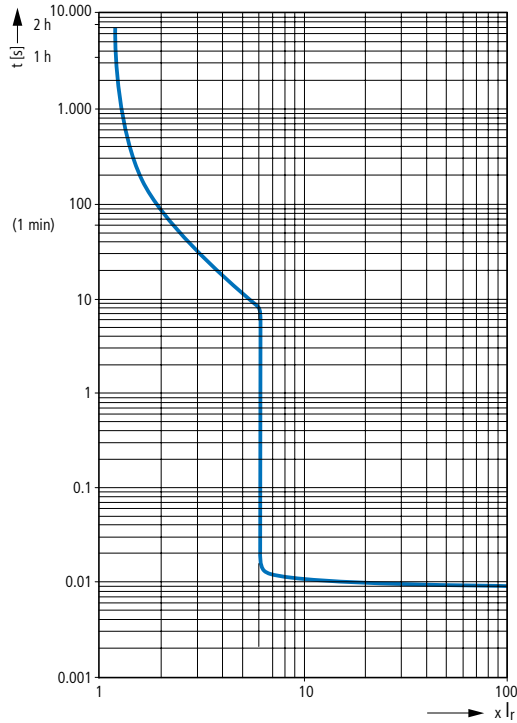

Limits for the delay times used to maintain operation in the event of voltage fluctuations.
Fireman's switch SOL30(X...)-Safety, undervoltage release P-SOL-XUV

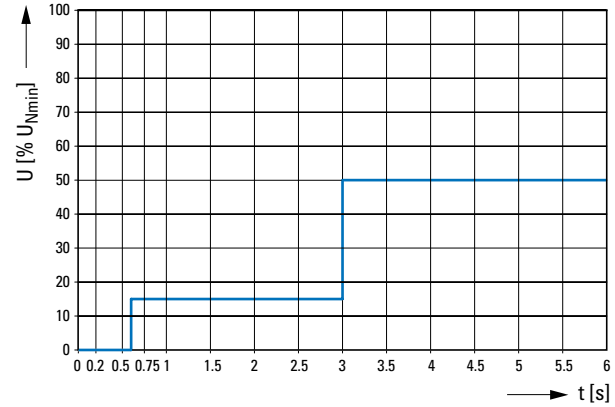

5

Set value of the short-circuit current

As specified in the IEC 62548-1 draft for the protection of photo voltaic modules, the tripping current of the circuit-breaker must fall between 1.4 to 2 times the value of the photo voltaic module's short-circuit current.

Since only the current values of the installed overload release can be plotted on the setting scale for the circuit-breaker¹⁾, the correlation between the protective device's tripping current and the photo voltaic module's

short-circuit current must be specified for each point of the scale in a suitable form.

Setting aid for string circuit-breaker PKZ-SOL

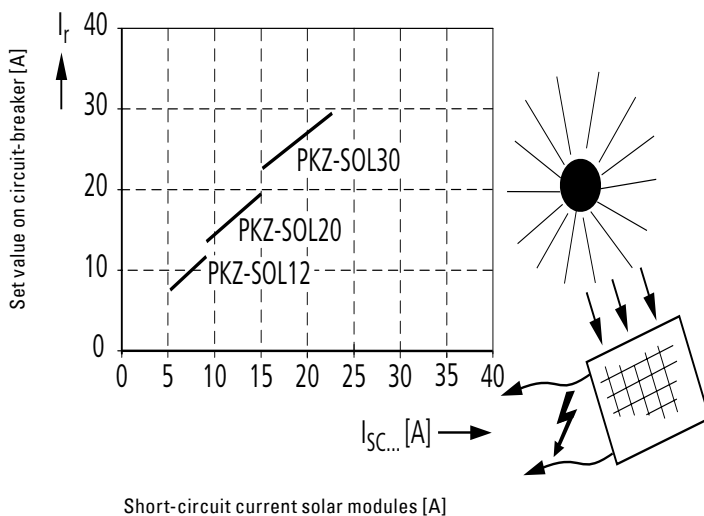

¹⁾ Standard IEC/EN 60947-2 (Section 4.7.3) prohibits directly specifying the photo voltaic short-circuit current on the circuit-breaker's setting scale, meaning that only the current set value of the operating current can be plotted there.

Technical data

		DILDC300 DILDC400	DILDC500 DILDC600
General			
Standards		EN60947-4-1, EN60947-5-1	EN60947-4-1, EN60947-5-1
Lifespan, mechanical			
AC operated	Operations	$x 10^6$ 1	1
DC operated	Operations	$x 10^6$ 1	1
Operating frequency, mechanical			
AC operated	Operations/h	1000	1000
DC operated	Operations/h	1000	1000
Maximum operating frequency			
electrical (Contactor without overload relay)	Operations/h	100	100
Climatic proofing			
		Damp heat, constant, to IEC 60068-2-78 Damp heat, cyclic, to IEC 60068-2-30	
Operating ambient temperature			
open	°C	-40 – 70	-40 – 70
enclosed	°C	-40 – 40	-40 – 40
Storage	°C	-40 – 80	-40 – 80
Mounting position			
Mechanical shock resistance (IEC/EN 60068-2-27), half-sinusoidal shock 10 ms			
Main contacts			
N/O	g	10	10
Auxiliary contacts			
N/O	g	10	10
N/C	g	8	8
Protection rating			
		IP00	IP00
Weight			
	kg	7.5	7.5
Terminal capacities, main cable			
Flexible with cable lug	mm ²	50 - 240	50 - 240
Stranded with cable lug	mm ²	50 - 240	50 - 240
Solid or stranded	AWG	1/0 - 500 MCM	1/0 - 500 MCM
busbar	Width	mm 40	40
Terminal Screw			
		M10	M10
Tightening torque			
	Nm	24	24
Terminal capacity control circuit cable			
Solid	mm ²	1 x (0.75 - 2.5) 2 x (0.75 - 2.5)	1 x (0.75 - 2.5) 2 x (0.75 - 2.5)
flexible with ferrule	mm ²	1 x (0.75 - 2.5) 2 x (0.75 - 2.5)	1 x (0.75 - 2.5) 2 x (0.75 - 2.5)
Solid or stranded	AWG	2 x (18 - 12)	2 x (18 - 12)
Terminal Screw			
		M3.5	M3.5
Tightening torque			
	Nm	1.2	1.2
Main cable tool			
Spanner	mm	16	16
Control circuit cable tool			
Pozidriv screwdriver	Size	2	2
Standard screwdriver	mm	0.8 x 5.5 1 x 6	0.8 x 5.5 1 x 6

DILDC DC contactors

			DILDC300 DILDC400	DILDC500 DILDC600
Main circuits				
Rated impulse withstand voltage	U_{imp}	V	8000	8000
Overvoltage category/degree of pollution			III/3	III/3
Rated insulation voltage	U_i	V DC	1000	1000
Rated operating voltage	U_e	V DC	1000	1000
Safe isolation according to EN 61140				
Between control inputs and main contacts		V	1000	1000
Between auxiliary contacts and main contacts		V	1000	1000
between the contacts		V	1000	1000
Making capacity (cos φ to IEC/EN 60947)		A	450 600	750 900
Breaking Capacity				
220 V 230 V		A	450	750
380 V 400 V			600	900
500 V				
660 V 690 V				
1000 V				
Electrical lifespan at 100% I_e		Operations x 10 ⁶	0.15	
Short-circuit rating - short-circuit protection max. Fuse				
Type of coordination "1"				
400 V DC 690 V DC 1000 V DC	gR 1000 V DC	A	450 (max. short-circuit current 6 kA) 630(max. short-circuit current 6 kA)	700 (max. short-circuit current 6 kA) 900 (max. short-circuit current 6 kA)
Type of coordination "2"				
400 V DC 690 V DC 1000 V DC	gR 1000 V DC	A	450 (max. short-circuit current 30 kA) 630 (max. short-circuit current 30 kA)	700 (max. short-circuit current 30 kA) 900 (max. short-circuit current 30 kA)
DC Voltage				
Connections	$x U_s$		→ 1/97	
Rated operational current I_e open				
DC-1, 1000 V	I_e	A	300 400	500 600
Current heat loss				
1-pole	At I_{th}	W	18 32	50 72
Magnet systems				
Voltage tolerance		U_s	110 - 250 V 40-60 Hz 110 - 350 V DC	
AC operated	Pick-up		$0.7 \times U_{S \min} - 1.15 \times U_{S \max}$	
DC operated	Pick-up		$0.7 \times U_{S \min} - 1.15 \times U_{S \max}$	
AC operated	Drop-out		$0.2 \times U_{S \max} - 0.6 \times U_{S \min}$	
DC operated	Drop-out		$0.2 \times U_{S \max} - 0.6 \times U_{S \min}$	
Actuation directly from PLC				
Rated control voltage		U_c	24 V DC	24 V DC
Rated control voltage		$U_{c \min - \max}$	15 - 31.2 V DC	15 - 31.2 V DC
Power consumption of the coil in a cold state and 1.0 x U_c				
Note on power consumption			Control transformer with $u_k \leq 6\%$	
Pick-up power	Pick-up	VA	600	600
Pick-up power	Pick-up	W	550	550
Sealing power	Hold	VA	18	18
Sealing power	Hold	W	9.5	9.5
Duty factor		% ED	100	100
Changeover time at 100% U_s (recommended values), main contacts				
Closing time		ms	80	80
Opening time		ms	40	40
PLC signal level (A3 - A4) to IEC/EN 61131-2 (part no. 2)				
High		V	15	15
Low		V	5	5

DILDC DC contactors

	DILDC300 DILDC400		DILDC500 DILDC600	
Electromagnetic compatibility (EMC)				
This is a product for environment A. In a domestic environment, this device may cause radio interference, in which case the user may be required to take adequate measures.				
Rating data for approved types				
Switching capacity				
General use				
Power circuit	A	300 400	500 600	
Auxiliary contact				
Pilot duty				
AC operated		A600	A600	
DC operated		P300	P300	
General Use				
AC	V	600	600	
AC	A	15	10	
DC	V	250	250	
DC	A	1	1	

SOL, P-SOL DC switch-disconnectors

		SOL20		SOL30
Rated operational current I_e at DC-21A	A	20	30	30
Number of poles		2	2	2
Rated operating voltage U_e	V DC	1000	1000	1000
Isolating characteristics		yes	yes	yes
Standards		IEC/EN 60 947-3 TÜV certificate		
Lifespan, mechanical	Operations	100,000	100,000	100,000
Lifespan electrical	Operations	100,000	100,000	100,000
Max. Operating frequency, mechanical	ops./h	120	120	120
Climatic proofing		Damp heat, constant to IEC 60 068-2-78 Damp heat, cyclic, to IEC 60 068-2-30		
Ambient temperature	°C	-25 – 60	-25 – 60	-25 – 60
Mounting position		Any	Any	Any
Protection rating	IP	65	65	65
Dimensions				
Width	mm	100	100	100
Height	mm	215	215	215
Depth	mm	130	130	130
Weight	kg	0.42	0.42	0.42
Lockable in OFF position		yes	yes	yes
Rated short-time withstand current 1 sec. to EN 60947-3	I_{cw}	kA	0.24	0.36
Rated short-circuit making capacity to EN 60947-3	I_{cm}	kA	0.32	0.32
Internal resistance	mΩ	8	7	7

		P-SOL20		P-SOL30	P-SOL60
Rated operational current at DC-21A	I_e	A	20	30	63
Number of poles			2	2	2
Rated operating voltage	U_e	V DC	1000	1000	1000
Isolating characteristics			yes	yes	yes
Standards			IEC/EN 60 947-3 UL 508, CSA-C22.2 No. 14-10, TÜV certificate		
Lifespan, mechanical	Operations		100,000	100,000	30,000
Lifespan electrical	Operations		100,000	100,000	30,000
Max. Operating frequency, mechanical		ops./h	120	120	120
Climatic proofing			Damp heat, constant to IEC 60 068-2-78 Damp heat, cyclic, to IEC 60 068-2-30		
Ambient temperature					
Open		°C	-25 – 60	-25 – 60	-25 – 60
Mounting position			Any	Any	Any
Dimensions					
Width		mm	58	58	55
Height		mm	93	93	140
Depth		mm	76	76	160
Mounting					
DIN-rail			35 mm	35 mm	35 mm
Screw fixing			–	–	2 x M4 x 18 30 x 130
Weight		kg	0.32	0.32	1.25
Terminals					
flexible with ferrule		mm ²	1 x (1-6)	1 x (1-6)	1 x (1-35)
		mm ²	2 x (1-6)	2 x (1-6)	2 x (1-35)
solid/stranded		AWG	18 - 14	18 - 14	14 - 2
Rated short-time withstand current 1 sec. to EN 60947-3	I_{cw}	kA	0.24	0.36	0.72
Rated short-circuit making capacity to EN 60947-3	I_{cm}	kA	0.32	0.32	0.6
Internal resistance		mΩ	6	5	3

Fireman's switch SOL30...-SAFETY, undervoltage release P-SOL-XUV

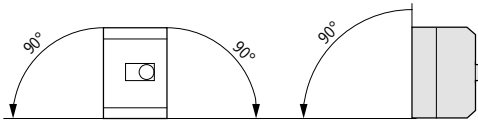
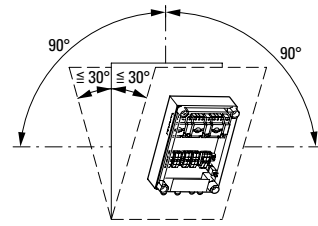
	SOL30-SAFETY		SOL30X...SAFETY	
General				
Standards	IEC/EN 60 947-3		IEC/EN 60 947-3	
Mounting position				
Operating ambient temperature	°C	-25 – 60	-25 – 60	
Ambient temperature				
Open	°C	-25 – 60	-25 – 60	
Climatic proofing	Damp heat, constant, to IEC 60068-2-78 Damp heat, cyclic, to IEC 60068-2-30			
Electrical				
Number of poles			2	2
Rated operating voltage	U_e	V DC	1000	1000
Rated operational current at DC-21A	I_e	A	30	30
Rated short-circuit making capacity up to 440 V 50/60 Hz	I_{cm}	kA	0.3	0.3
Rated short-time withstand current (t = 1 s)	I_{cw}	kA	0.7	0.7
Utilization category			DC-21 A	DC-21 A
Overvoltage category/degree of pollution			III/3	III/3
Rated impulse withstand voltage	U_{imp}	kV	8	8
Lifespan electrical	Operations		1500	1500
Internal resistance		mΩ	7	7
Mechanical				
Protection rating			IP65	IP65
Weight		Kg	See data sheet in online catalog	
Lifespan, mechanical	Operations		100,000	100,000
max. Operating frequency	ops./h	ops./h	120	120
			P-SOL-XUV (24 VDC)	P-SOL-XUV (110/120/230/240 V 50/60 Hz)
General				
Terminal capacity	mm ²			
Solid/flexible, with ferrule	mm ²	1 x (0.75 - 2.5) 2 x (0.75 - 2.5)		
Solid or stranded	AWG	1 x (18 - 14) 2 x (18 - 14)		
Operating ambient temperature	°C	-25 – 60	-25 – 60	
Main circuits				
Rated operating voltage	U_e	V AC		
Rated operating voltage min.	U_e	V AC/DC	24 V DC	110/230 V AC
Rated voltage max.	U_e	V AC/DC	24 V DC	120/240 V AC
Pick-up voltage				
Pick-up voltage	$x U_s$			
Pick-up voltage	min./max.	$x U_s$	0.85 - 1.1	0.85 - 1.1
Power consumption				
Alternating voltage				
Pull-in power AC	Pick-up	VA	–	3
Sealing AC	Hold	VA	–	3
DC Voltage				
Pull-in power DC	Pick-up	W	3	–
Sealing DC	Hold	W	3	–

NAS network and system protection

			NAS63	NAS80	NAS125	NAS160
General						
Rated operating voltage	U_e	V AC	400	400	400	400
Motor rating						
AC-1 400 V	P	kVA	43	55	86	100
Standards						
			VDE-AR-N 4105	VDE-AR-N 4105	VDE-AR-N 4105	VDE-AR-N 4105
Ambient temperature						
Open		°C	-20 – 40	-20 – 40	-20 – 40	-20 – 40
Enclosed		°C	-20 – 40	-20 – 40	-20 – 40	-20 – 40
Storage		°C	-40 – 80	-40 – 80	-40 – 80	-40 – 80
Mounting position						

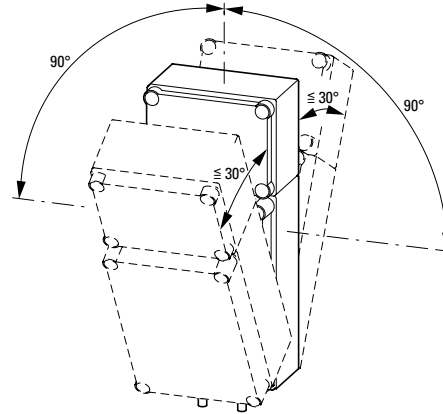

Electrical						
Total switch-off time with NA protection relay		ms	< 150	< 150	< 150	< 150
Rated duty factor		% ED	100	100	100	100
Terminal capacities, main cable						
Solid		mm ²	1 x (2.5 - 16)	1 x (2.5 - 16)	–	–
Flexible		mm ²	1 x (2.5 - 35)	1 x (2.5 - 35)	–	–
Stranded		mm ²	1 x (16 - 50)	1 x (16 - 50)	–	–
Terminal capacity PE terminals						
Solid		mm ²	1 x (16 - 50)	1 x (16 - 50)	–	–
Flexible		mm ²	1 x (25 - 50)	1 x (25 - 50)	–	–
Stranded		mm ²	1 x (25 - 50)	1 x (25 - 50)	–	–
Terminal capacity, main cable and PE terminals						
Cu cable - Round cable stranded, sector cable stranded, round cable solid, sector cable solid		mm ²	–	–	1 x 16 - 95	1 x 16 - 95
Al cable - Round cable solid, sector cable solid		mm ²	–	–	1 x 16 - 95	1 x 16 - 95
Al cable - Sector cable stranded		mm ²	–	–	1 x 35 - 70	1 x 35 - 70
Coupler switch	Type	Quantity: 2	DILMP63 (RAC240)	DILMP80 (RAC240)	DILMP125 (RAC240)	DILMP160 (RAC240)
Making capacity (cos φ) to IEC/EN 60947	Up to 690 V	A	560	700	1120	1330
Breaking Capacity						
380 V 400 V		A	400	500	800	950
Short-circuit protection max. Fuse						
400 V	gG/gL 500 V	A	125	160	250	250
Prospective short-circuit current						
		kA	100	100	100	100
Changeover time at 100% UC (recommended value)						
Opening time		ms	45	45	40	40
Rated control voltage	U_s	V	230 V AC	230 V AC	230 V AC	230 V AC
Power consumption of the coil in a cold state and 1.0 x U_e						
AC operated 50/60 Hz	Pick-up	VA	90 (2 x DILMP)	90 (2 x DILMP)	360 (2 x DILMP)	360 (2 x DILMP)
AC operated 50/60 Hz	Hold	VA	3 (2 x DILMP)	3 (2 x DILMP)	6.2 (2 x DILMP)	6.2 (2 x DILMP)

DC String circuit-breaker PKZ-SOL

			PKZ-SOL12	PKZ-SOL20	PKZ-SOL30
Rated operational current at DC-21A	I_e	A	12	20	30
Number of poles			2	2	2
Rated operational voltage	U_e	V DC	900	900	900
Thermal trip			1.05 - 1.3 x I_e		
Electromagnetic trip block			6 x I_e		
Standards			IEC/EN 60 947-2 TÜV certificate		
Climatic proofing			Damp heat, constant to IEC 60 068-2-78 Damp heat, cyclic, to IEC 60 068-2-30		
Ambient temperature					
Open		°C	-25 – 60	-25 – 60	-25 – 60
Mounting position					
Dimensions					
Width		mm	58	58	58
Height		mm	93	93	93
Depth		mm	76	76	76
Mounting					
DIN-rail			35 mm	35 mm	35 mm
Screw fixing			–	–	–
Weight		kg	0.32	0.32	0.32
Terminals					
flexible with ferrule		mm ²	1 x (1-6)	1 x (1-6)	1 x (1-6)
		mm ²	2 x (1-6)	2 x (1-6)	2 x (1-6)
solid/stranded		AWG	18 - 14	18 - 14	18 - 14
Internal resistance		mΩ	31	12	7

5

Dimensions

DC contactors DILDC300 - DILDC600

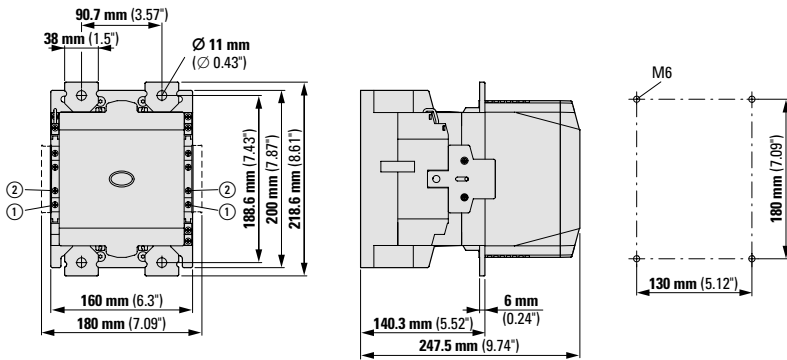

SOL30-SAFETY fireman's switch

SOL30X4-SAFETY

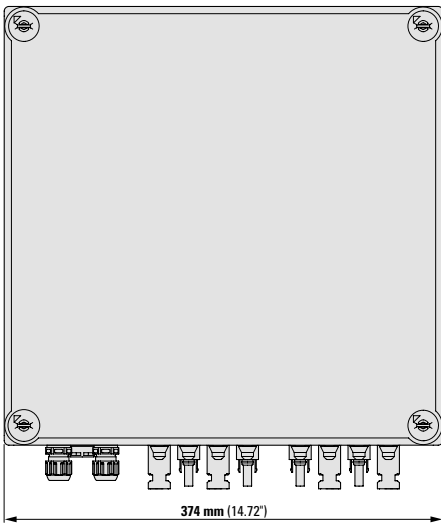

	a	
	mm (inch)	
	...MC4	...MV
SOL30X4-SAFETY-...	411 (16.18)	404 (15.91)

SOL30X2(3)-SAFETY

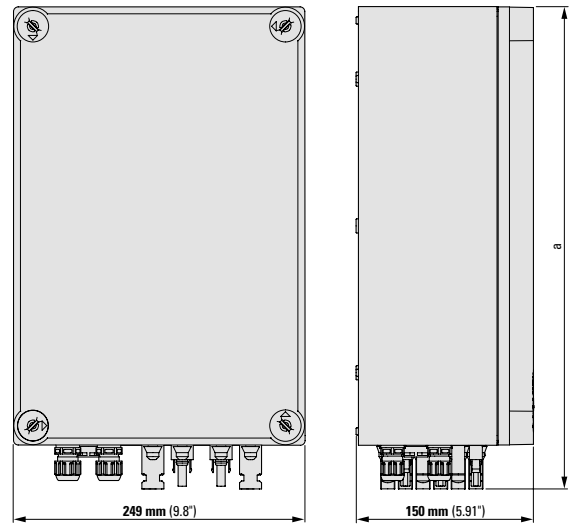

	a	
	mm (inch)	
	...MC4	...MV
SOL30X2-SAFETY-...	411 (16.18)	404 (15.91)
SOL30X3-SAFETY-...	411 (16.18)	404 (15.91)

SOL30X6-SAFETY

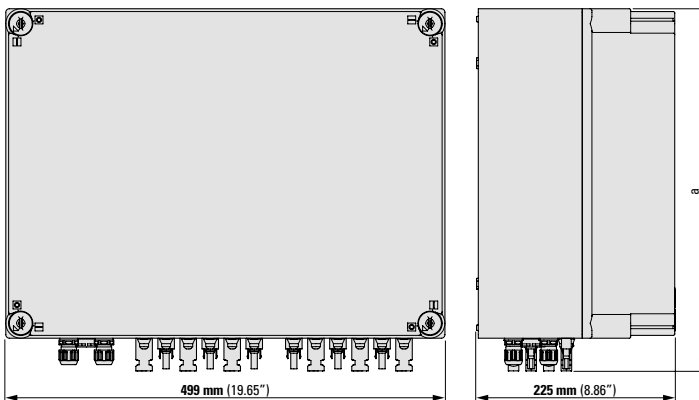

	a	
	mm (inch)	
	...MC4	...MV
SOL30X6-SAFETY-...	411 (16.18)	404 (15.91)

SOL30-SAFETY/2

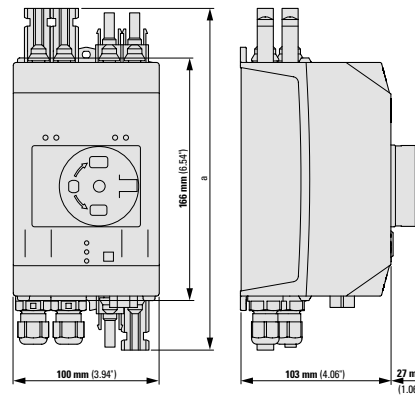

	a	
	mm (inch)	
	...MC4	...MV
SOL30-SAFETY/2...	234 (9.21)	224 (8.82)

NAS network and system protection, DC switchgear P-SOL, PKZ-SOL, SOL20, SOL30

NAS network and system protection

NAS63

NAS80

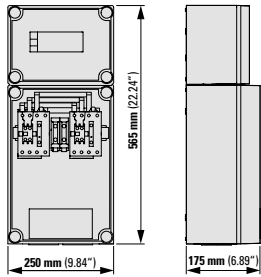

NAS125

NAS160

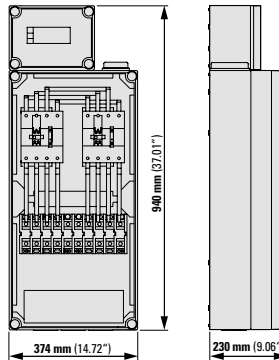

P-SOL20

P-SOL30

PKZ-SOL12

PKZ-SOL20

PKZ-SOL30

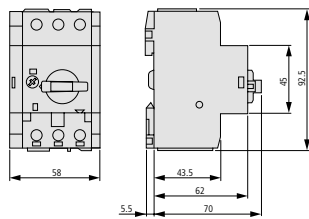

P-SOL60

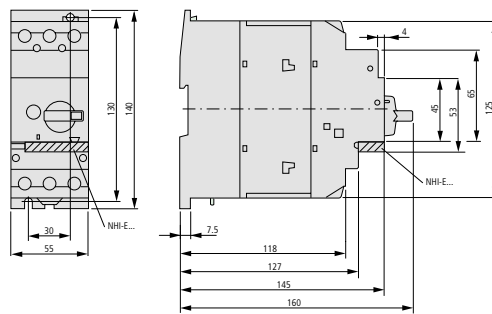

SOL20

SOL30

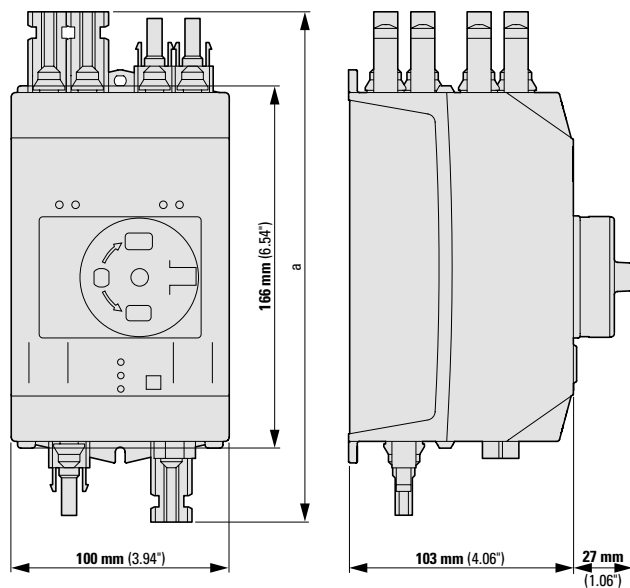

SOL20...	a
SOL30...	mm
MC4	234
MV	224



Worldwide export of machines and plants

European machine and system building and worldwide exports are closely related. Even if you don't export your machines at present, you should be prepared for it in the future. Eaton provides switchgear and protective devices with all the essential approvals and certificates for machine and system building. In most countries around the world, conformity with international standards is the sole requirement for successful exports. This is because components in these locations are governed by compliance with well-known and established IEC standards. In this respect, the European CE mark is not only the "passport" for exports within Europe but also far beyond its borders.



World market equipment for machine building

The majority of the switchgears and protective devices of the Moeller® series from Eaton are global market devices. The basic versions of these devices have all the approvals and certifications. As universal devices, they can be used throughout the world.

These product lines include those for

- Pilot devices, position switches,
- Contactors and various timing and special relays,
- Motor-protective circuit-breakers and overload relays,
- Electronic components and systems.

With circuit-breakers and switch-disconnectors, Eaton offers IEC devices for use in most countries in the world and special devices with virtually the same dimensions and the same accessories for the North American market.



www.eaton.de/export

Our service, your benefit

- Reduction of resources and investments
- Reduction of assembly costs & times
- Focus on core competencies
- Reduction of packaging waste
- Storage processes, inventories & supply chains are optimized
- Using correct product combinations to reduce errors

VAS-EMEA@eaton.com



Increased efficiency means eliminating unnecessary work. This can be particularly valuable to logistics operations, where valuable time is often lost due to unnecessary operator intervention. By using our value-added services, you can streamline the logistics processes in your company so that they will be as smooth and efficient as possible.

Intralogistics: We will supply you with products exactly as you need them – even unpacked in reusable transport containers if necessary. And if you use items assembled from multiple Eaton products, we will be more than glad to deliver them to you pre-assembled.

Production: We will package your goods exactly as you need – even if that means you require them in unusual configurations. And if you need to export those goods, we will make sure to deliver them in appropriate special packaging suitable for international shipping. We can, of course, add custom labels with your own item numbers to the products we deliver as well.

Other benefits:

- Harmonized logistics concepts
- Product range optimization for your warehouse
- Special packaging concepts
- Set delivery days as agreed
- Support with all questions concerning logistics
- Customer-oriented logistics reports
- Customs clearance
- Help with compliance screening (compliance with anti-terrorism regulations)
- Order management services in multiple languages every day from 7:00 AM to 8:00 PM
- Shipment tracking
- Returns management



To find the right contact person:



At Eaton, we believe that building and maintaining strong relationships with our customers is something that deserves our undivided attention. This is how we guarantee our support for every project from the very start.

To find out whom to contact for your needs, please visit our website:

To find the right contact person anywhere in the world, visit:

→ www.eaton.eu/contact

Eaton's After Sales Service

Eaton is known for its unparalleled after-sales support for all low-voltage switchgear, switchgear systems, and services. For more detailed information, as well as to view our terms and conditions, please visit:

www.eaton.eu/aftersales

Service specialists

Call on our service personnel. Their comprehensive knowledge, many years of experience and modern equipment can assist you in finding the ideal solutions for your tasks.

Material

Components, assemblies and spare parts of the product range from Eaton are available for your applications.

Service products

The after-sales service offers appropriate service products for Eaton products.

Helpline

Hotline

24-hour breakdown service.

+49 (0)180 522 3822 (24/7)*

Help desk

+49 (0)228 602-3640

Mo-Fr from 8:00 – 16:00 CET

E-mail: AfterSalesEGBonn@eaton.com

Onsite Service

Troubleshooting, inspections, tests, maintenance, commissioning

Repairs

Replacement devices and spare parts for current and expired products, direct/warranty exchange for selected products, repairs

Online Services

Downloads, FAQs and interactive troubleshooting.

*EUR 0.14 per minute for calls from Deutsche Telekom's network

At Eaton, we are solution-driven, supplying energy to a world that is ever more demanding. With over 100 years of expertise in the area of power management, we are ready for the future. Core industries all around the globe rely on Eaton and on our pioneering products, total solutions and engineering services.

Companies know they can always trust our reliable, efficient, and safe power management solutions. Together with our personalized service and support, as well as our forward-looking attitude, these solutions meet the needs of tomorrow, today. Follow the charge. Visit **eaton.eu**.

The products, information and prices contained in this document are subject to change. We also reserve the right to correct any errors or omissions. Only the order confirmation and the technical documentation from Eaton are binding. Photos and illustrations do not guarantee a particular visual appearance or functionality. Their use in any form must be approved in advance by Eaton. The same applies to Trademarks (especially Eaton, Moeller, Cutler-Hammer). Eaton's terms of sale as published on Eaton's websites and included with Eaton's order confirmations apply.

Eaton Industries GmbH
Hein-Moeller-Str. 7-11
D-53115 Bonn/Germany

© 2017 by Eaton Corporation
All rights reserved
Name: CA034001EN
Version 1.0 / December 2017 / CSSC-803 / ZO
Article no. 197578



Eaton is a registered trademark of Eaton Corporation.

All other trademarks are property of their respective owners.