

DF2005-G Thru. DF210-G

Reverse Voltage: 50 to 1000V

Forward Current: 2.0A

RoHS Device

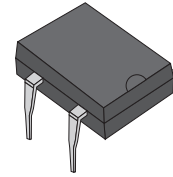

Features

- Rating to 1000V PRV.
- Ideal for printed circuit board.
- Low forward voltage drop.
- High current capability.
- The plastic material has UL flammability classification 94V-0
- UL recognized file # E349301

Mechanical Data

- Polarity: As marked on Body.
- Weight: 0.38 grams.
- Mounting position: Any.

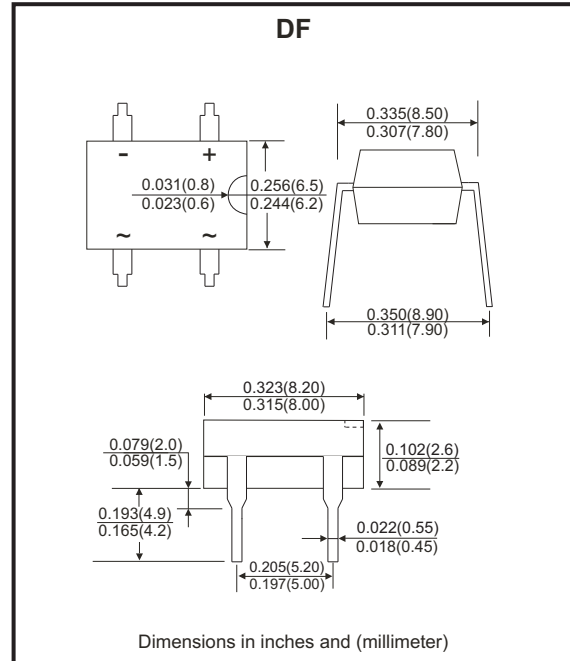

Maximum ratings and electrical characteristics

Rating at 25°C ambient temperature unless otherwise specified.
 Single phase, half wave, 60Hz, resistive or inductive load.
 For capacitive load, derate current by 20%

| Parameter | Symbol | DF 2005-G | DF 201-G | DF 202-G | DF 204-G | DF 206-G | DF 208-G | DF 210-G | Unit |
|--|-----------------|------------|----------|----------|----------|----------|----------|----------|---------------------------|
| Maximum Recurrent Peak Reverse Voltage | V_{RRM} | 50 | 100 | 200 | 400 | 600 | 800 | 1000 | V |
| Maximum RMS Voltage | V_{RMS} | 35 | 70 | 140 | 280 | 420 | 560 | 700 | V |
| Maximum DC Blocking Voltage | V_{DC} | 50 | 100 | 200 | 400 | 600 | 800 | 1000 | V |
| Maximum Average Forward Rectified Current @ $T_A=40^\circ\text{C}$ | $I_{(AV)}$ | 2.0 | | | | | | | A |
| Peak Forward Surge Current , 8.3ms Single Half Sine-Wave Super Imposed on Rated Load | I_{FSM} | 60 | | | | | | | A |
| I^2t Rating for Fusing ($t < 8.3\text{ms}$) | I^2t | 14.94 | | | | | | | A^2s |
| Maximum Forward Voltage at 2.0A DC | V_F | 1.1 | | | | | | | V |
| Maximum DC Reverse Current @ $T_J = 25^\circ\text{C}$ at Rated DC Blocking Voltage @ $T_J = 125^\circ\text{C}$ | I_R | 10 500 | | | | | | | μA |
| Typical Junction Capacitance Per Element (Note 1) | C_J | 25 | | | | | | | pF |
| Typical Thermal Resistance (Note 2) | $R_{\theta JA}$ | 40 | | | | | | | $^\circ\text{C}/\text{W}$ |
| Operating Temperature Range | T_J | -55 ~ +150 | | | | | | | $^\circ\text{C}$ |
| Storage Temperature Range | T_{STG} | -55 ~ +150 | | | | | | | $^\circ\text{C}$ |

Notes:

1. Measured at 1.0MHz and applied reverse voltage of 4.0V DC
2. Unit mounted on P.C.B with 0.50"×0.50" (13×13mm) copper pads.

Company reserves the right to improve product design , functions and reliability without notice.

REV: F

Rating and Characteristics Curves (DF2005-G Thru. DF210-G)

Fig.1 - Derating Curve For Output Rectified Current

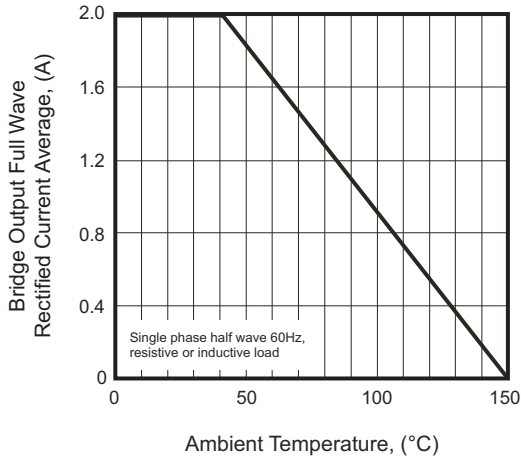

Fig.2 - Maximum Non-Repetitive Peak Forward Surge Current

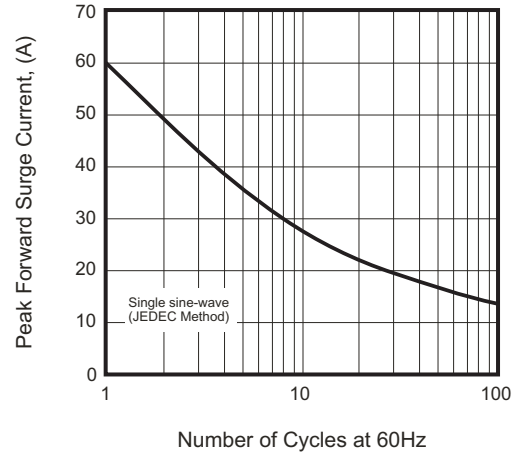

Fig.3 - Typical Junction Capacitance

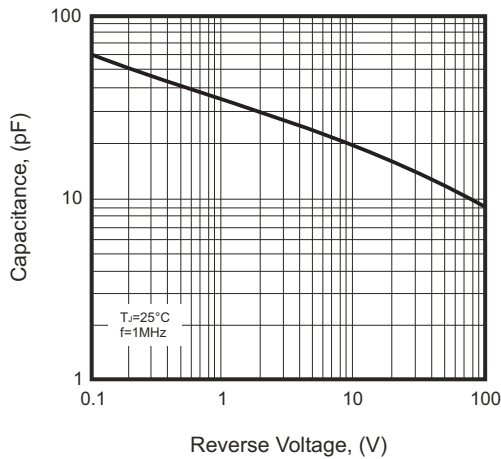

Fig.4 - Typical Forward Characteristics

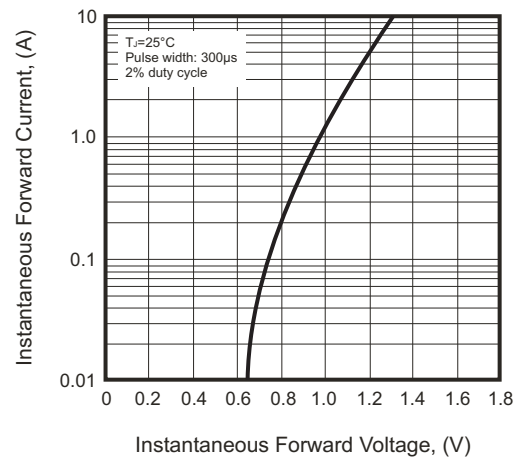
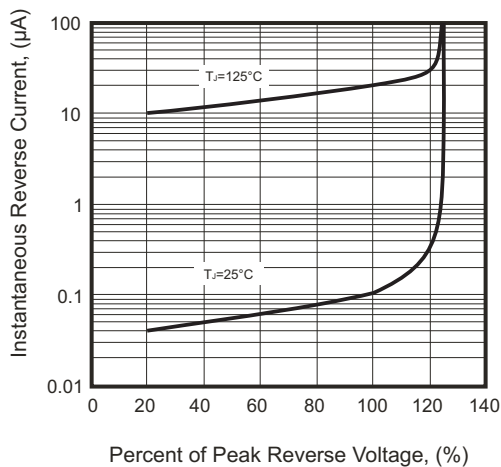
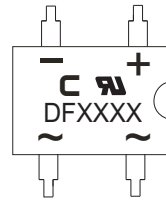

Fig.5 - Typical Reverse Characteristics



Marking Code

| Part Number | Marking code |
|-------------|--------------|
| DF2005-G | DF2005 |
| DF201-G | DF201 |
| DF202-G | DF202 |
| DF204-G | DF204 |
| DF206-G | DF206 |
| DF208-G | DF208 |
| DF210-G | DF210 |



XXXX / XXX = Product type marking code
 C = Comchip Logo

Standard Packaging

| Case Type | TUBE PACK | |
|-----------|-----------------|----------------|
| | TUBE (pcs) | BOX (pcs) |
| DF | 50 | 2,500 |

Mouser Electronics

Authorized Distributor

Click to View Pricing, Inventory, Delivery & Lifecycle Information:

[Comchip Technology:](#)

[DF208-G](#)