

## 600 WATT TRANSIENT VOLTAGE SUPPRESSORS

### FEATURES

- PROPRIETARY **SOFT GLASS<sup>®</sup>** JUNCTION PASSIVATION FOR SUPERIOR RELIABILITY AND PERFORMANCE
- VOID FREE VACUUM DIE SOLDERING FOR MAXIMUM MECHANICAL STRENGTH AND HEAT DISSIPATION
- 600 Watt peak power capability on 10/1000 S waveform
- Excellent clamping capability
- Repetition rate (Duty Cycle): 0.01%
- Low incremental surge resistance
- Fast response time (0 to BV Volts)
  - Unidirectional* - typically less than 1pS
  - Bidirectional* - typically less then 5nS
- Typical Reverse Leakage ( $I_D$ ) less than 1 A above 10 Volts

### MECHANICAL DATA

- Case: JEDEC DO-41 molded epoxy (UL Flammability Rating 94V-0)
- Terminals: Plated Axial Leads
- Soldering: Per MIL-STD 202 Method 208 guaranteed
- Mounting Position: Any
- Polarity: Color band denotes cathode
- Weight: 0.012 Ounces (0.34 Grams)

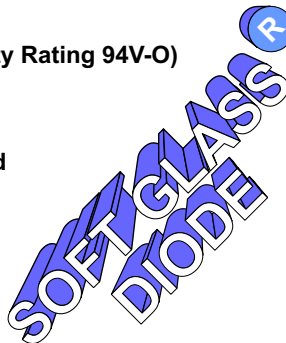

### MECHANICAL SPECIFICATION

ACTUAL SIZE OF DO-41 PACKAGE



DO - 41

### SERIES P6KE6.8 - P6KE400CA

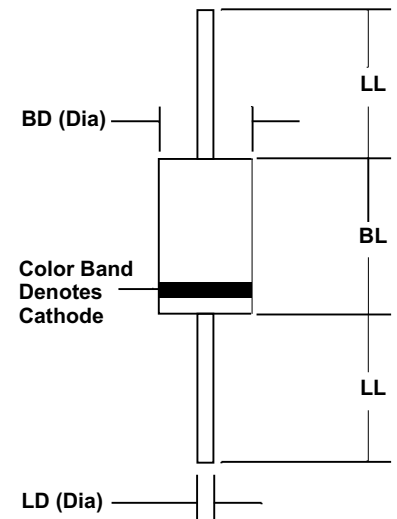

Sym	Minimum		Maximum	
	In	mm	In	mm
BL	0.160	4.1	0.205	5.2
BD	0.103	2.6	0.107	2.7
LL	1.00	25.4		
LD	0.028	0.71	0.034	0.86

### MAXIMUM RATINGS & ELECTRICAL CHARACTERISTICS

Ratings at 25 °C ambient temperature unless otherwise specified. Resistive or inductive load.

PARAMETER (TEST CONDITIONS)	SYMBOL	RATINGS	UNITS
Peak Pulse Power Dissipation on 10/1000 $\mu$ S Waveform (Note 1, Fig 1)	PPPM	Minimum 600	WATTS
Peak Pulse Current on 10/1000mS Waveform (Note 1, Fig 1)	IPPM	See Table 1	AMPS
Steady State Power Dissipation at $T_L = 75^\circ\text{C}$ With Lead Length = 0.375" (9.5mm) (Note 2)	PM(AV)	5.0	WATTS
Peak Forward Surge Current (8.3mS Single Half Sine Wave Superimposed on Rated Load - JEDEC Method) Unidirectional Only. (Note 2)	IFSM	100	AMPS
Maximum Instantaneous Forward Voltage at 50A; Unidirectional Only (Note 2)	V <sub>F</sub>	3.5	VOLTS
Junction Operating & Storage Temperature Range	T <sub>J</sub> , T <sub>STG</sub>	-65 to +175	°C/W

Notes:

- 1) Non-Repetitive Current Pulse Per Fig. 3 and Derated Above  $T_A = 25^\circ\text{C}$  Per Fig 2.
- 2) Mounted on Copper Leaf Area of 1.58 in<sup>2</sup> (40mm<sup>2</sup>) Per Fig 5.
- 3) 8.3mS Single Half Sine Wave or Equivalent Square Wave. Duty Cycle = 4 Pulses Per Minute Maximum.

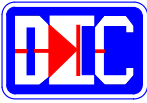

# 600 WATT TRANSIENT VOLTAGE SUPPRESSORS

## RATINGS AND CHARACTERISTIC CURVES FOR SERIES P6KE6.8 - P6KE400CA

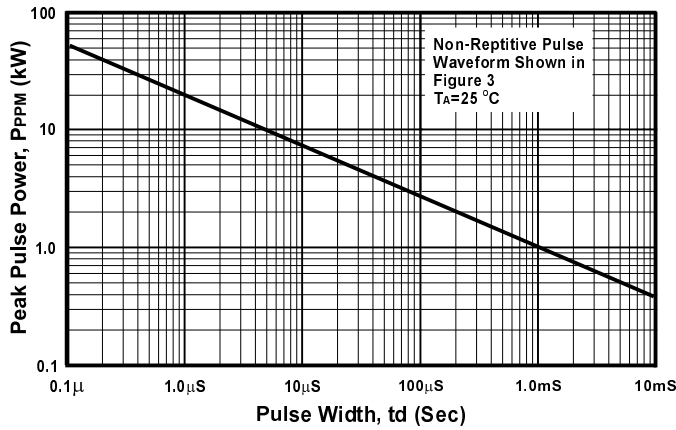

FIGURE 1. PEAK PULSE POWER RATING CURVE

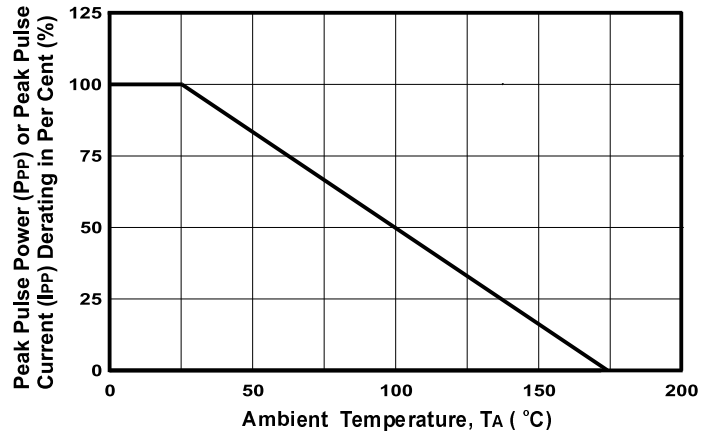

FIGURE 2. PULSE DERATING CURVE

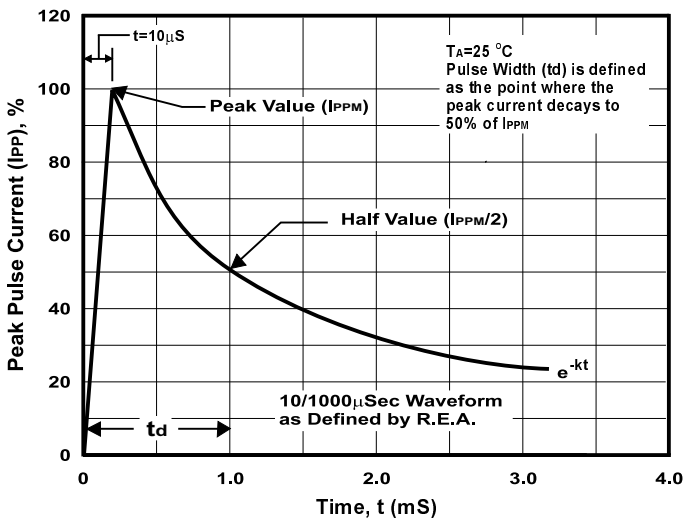

FIGURE 3. PULSE WAVEFORM

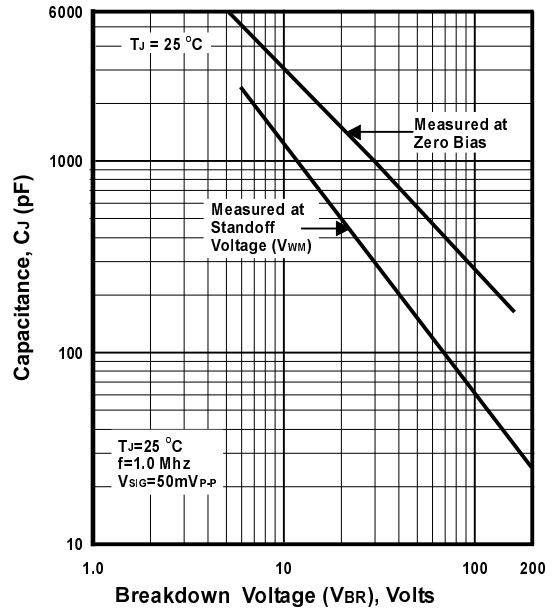

FIGURE 4. TYPICAL JUNCTION CAPACITANCE-UNIDIRECTIONAL

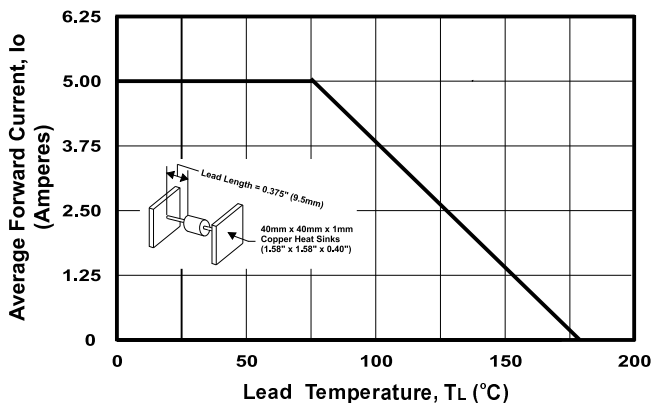

FIGURE 5. STEADY STATE POWER DERATING CURVE

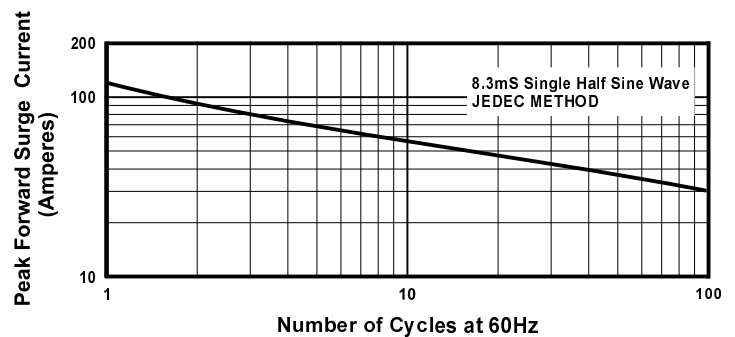
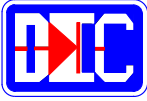

FIGURE 6. MAXIMUM NON-REPETITIVE PEAK FORWARD SURGE CURRENT - UNIDIRECTIONAL



## 600 WATT TRANSIENT VOLTAGE SUPPRESSORS

### RATINGS AND CHARACTERISTIC CURVES FOR SERIES P6KE6.8 - P6KE400CA

**FOR BIDIRECTIONAL APPLICATIONS:** USE "C" OR "CA" FOR TYPES P6KE6.8-PKE440. FOR EXAMPLE: P6KE6.8C OR P6KE400CA.  
 ELECTRICAL CHARACTERISTICS APPLY IN BOTH DIRECTIONS.

PART NO.	BREAKDOWN VOLTAGE (V <sub>BR</sub> ) (NOTE 1)			V <sub>WM</sub> (VOLTS)	MAX. I <sub>D</sub> @ V <sub>WM</sub> ( A ) (Note 3)	MAX. I <sub>PPM</sub> (AMPS) (Note 2)	V <sub>C</sub> @ I <sub>PPM</sub> (VOLTS)	MAX. TEMPERATURE COEFFICIENT OF V <sub>BR</sub> (% °C)
	VOLTS		@ I <sub>T</sub> (mA)					
	MIN	MAX						
P6KE6.8	6.12	7.48	10	5.50	1000	56	10.8	0.057
P6KE6.8A	6.45	7.14	10	5.80	1000	57	10.5	0.057
P6KE7.5	6.75	8.25	10	6.05	500	51	11.7	0.061
P6KE7.5A	7.13	7.88	10	6.40	500	53	11.3	0.061
P6KE8.2	7.38	9.02	10	6.63	200	48	12.5	0.065
P6KE8.2A	7.79	8.61	10	7.02	200	50	12.1	0.065
P6KE9.1	8.19	10.0	1.0	7.37	50	44	13.8	0.068
P6KE9.1A	8.65	9.55	1.0	7.78	50	45	13.4	0.068
P6KE10	9.00	11.0	1.0	8.10	10	40	15.0	0.073
P6KE10A	9.50	10.5	1.0	8.55	10	41	14.5	0.073
P6KE11	9.90	12.1	1.0	8.92	5.0	37	16.2	0.075
P6KE11A	10.5	11.6	1.0	9.40	5.0	38	15.6	0.075
P6KE12	10.8	13.2	1.0	9.72	5.0	35	17.3	0.078
P6KE12A	11.4	12.6	1.0	10.2	5.0	36	16.7	0.078
P6KE13	11.7	14.3	1.0	10.5	5.0	32	19.0	0.061
P6KE13A	12.4	13.7	1.0	11.1	5.0	33	18.2	0.081
P6KE15	13.5	16.5	1.0	12.1	5.0	27	22.0	0.084
P6KE15A	14.3	15.8	1.0	12.8	5.0	28	21.2	0.084
P6KE16	14.4	17.6	1.0	12.9	5.0	26	23.5	0.086
P6KE16A	15.2	16.8	1.0	13.6	5.0	27	22.5	0.086
P6KE18	16.2	19.8	1.0	14.5	5.0	23	26.5	0.088
P6KE18A	17.1	18.9	1.0	15.3	5.0	24	25.2	0.088
P6KE20	18.0	22.0	1.0	16.2	5.0	21	29.1	0.090
P6KE20A	19.0	21.0	1.0	17.1	5.0	22	27.7	0.090
P6KE22	19.8	24.2	1.0	17.8	5.0	19	31.9	0.092
P6KE22A	20.9	23.1	1.0	18.8	5.0	20	30.6	0.092
P6KE24	21.6	26.4	1.0	19.4	5.0	17	34.7	0.094
P6KE24A	22.8	25.2	1.0	20.5	5.0	18	33.2	0.094
P6KE27	24.3	29.7	1.0	21.8	5.0	15	39.1	0.096
P6KE27A	25.7	28.4	1.0	23.1	5.0	16	37.5	0.096
P6KE30	27.0	33.0	1.0	24.3	5.0	14	43.5	0.097
P6KE30A	28.5	31.5	1.0	25.6	5.0	14.4	41.4	0.097
P6KE33	29.7	36.3	1.0	26.8	5.0	12.6	47.7	0.098
P6KE33A	31.4	34.7	1.0	28.2	5.0	13.2	45.7	0.098
P6KE36	32.4	39.6	1.0	29.1	5.0	11.6	52.0	0.099
P6KE36A	34.2	37.8	1.0	30.8	5.0	12.0	49.9	0.099
P6KE39	35.1	42.9	1.0	31.6	5.0	10.6	56.4	0.100
P6KE39A	37.1	41.0	1.0	33.3	5.0	11.2	53.9	0.100
P6KE43	38.7	47.3	1.0	34.8	5.0	9.6	61.9	0.101
P6KE43A	40.9	45.2	1.0	36.8	5.0	10.1	59.3	0.101
P6KE47	42.3	51.7	1.0	38.1	5.0	8.9	67.8	0.101
P6KE47A	44.7	49.4	1.0	40.2	5.0	9.3	64.8	0.101

**Table Symbols:**

- V<sub>BR</sub> measured after I<sub>T</sub> applied for 300μS, I<sub>T</sub>=square wave pulse or equivalent
- Surge current waveform per Figure 3 and derate per Figure 2.
- For Bidirectional types with V<sub>R</sub> of 10 Volts and less, the I<sub>D</sub> limit is doubled
- All Terms and Symbols are consistent with ANSI/IEEE C62.35

- I<sub>D</sub> - Reverse Leakage Current
- I<sub>PPM</sub> - Maximum Peak Pulse Current
- I<sub>T</sub> - Test Current (To Determine V<sub>BR</sub>)
- mA - Milliampere
- Max. - Maximum
- Min - Minimum
- V<sub>BR</sub> - Breakdown Voltage
- V<sub>C</sub> - Clamping Voltage
- V<sub>WM</sub> - Reverse Standoff Voltage
- % - Per Cent
- °C - Degrees Celsius

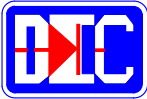

## 600 WATT TRANSIENT VOLTAGE SUPPRESSORS

### RATINGS AND CHARACTERISTIC CURVES FOR SERIES P6KE6.8 - P6KE400CA

**FOR BIDIRECTIONAL APPLICATIONS:** USE "C" OR "CA" FOR TYPES P6KE6.8-PKE440. FOR EXAMPLE: P6KE6.8C OR P6KE400CA.  
 ELECTRICAL CHARACTERISTICS APPLY IN BOTH DIRECTIONS.

PART NO.	BREAKDOWN VOLTAGE (V <sub>BR</sub> ) (NOTE 1)			V <sub>WM</sub> (VOLTS)	MAX. I <sub>D</sub> @ V <sub>WM</sub> (A) (Note 3)	MAX. I <sub>PPM</sub> (AMPS) (Note 2)	V <sub>C</sub> @ I <sub>PPM</sub> (VOLTS)	MAX. TEMPERATURE COEFFICIENT OF V <sub>BR</sub> (% °C)
	VOLTS		@ I <sub>T</sub> (mA)					
	MIN	MAX						
P6KE51	45.9	56.1	1.0	41.3	5.0	8.2	73.5	0.102
P6KE51A	48.5	53.6	1.0	43.6	5.0	8.6	70.1	0.102
P6KE56	50.4	61.6	1.0	45.4	5.0	7.4	80.5	0.103
P6KE56A	53.2	58.8	1.0	47.8	5.0	7.8	77.0	0.103
P6KE62	55.8	68.2	1.0	50.2	5.0	6.8	89.0	0.104
P6KE62A	58.9	65.1	1.0	53.0	5.0	7.1	85.0	0.104
P6KE68	61.2	74.8	1.0	55.1	5.0	6.1	98.0	0.104
P6KE68A	64.6	71.4	1.0	58.1	5.0	6.5	92.0	0.104
P6KE75	67.5	82.5	1.0	60.7	5.0	5.5	108	0.105
P6KE75A	71.3	78.8	1.0	64.1	5.0	5.8	103	0.105
P6KE82	73.8	90.2	1.0	66.4	5.0	5.1	118	0.105
P6KE82A	77.9	86.1	1.0	70.1	5.0	5.3	113	0.105
P6KE91	81.9	100	1.0	73.7	5.0	4.5	131	0.106
P6KE91A	86.5	95.5	1.0	77.8	5.0	4.8	125	0.106
P6KE100	90.0	110	1.0	81.0	5.0	4.2	144	0.106
P6KE100A	95.0	105	1.0	85.5	5.0	4.4	137	0.106
P6KE110	99.0	121	1.0	89.2	5.0	3.8	158	0.107
P6KE110A	105	116	1.0	94.0	5.0	4.0	152	0.107
P6KE120	108	132	1.0	97.2	5.0	3.5	173	0.107
P6KE120A	114	126	1.0	102	5.0	3.6	165	0.107
P6KE130	117	143	1.0	105	5.0	3.2	187	0.107
P6KE130A	124	137	1.0	111	5.0	3.3	179	0.107
P6KE150	135	165	1.0	121	5.0	2.8	215	0.108
P6KE150A	143	158	1.0	128	5.0	2.9	207	0.108
P6KE160	144	176	1.0	130	5.0	2.6	230	0.108
P6KE160A	152	168	1.0	136	5.0	2.7	219	0.108
P6KE170	153	187	1.0	138	5.0	2.5	244	0.108
P6KE170A	162	179	1.0	145	5.0	2.6	234	0.108
P6KE180	162	198	1.0	146	5.0	2.3	258	0.108
P6KE180A	171	189	1.0	154	5.0	2.4	246	0.108
P6KE200	180	220	1.0	162	5.0	2.1	287	0.108
P6KE200A	190	210	1.0	171	5.0	2.2	274	0.108
P6KE220	198	242	1.0	175	5.0	1.75	344	0.108
P6KE220A	209	231	1.0	185	5.0	1.83	328	0.108
P6KE250	225	275	1.0	202	5.0	1.67	360	0.110
P6KE250A	237	263	1.0	214	5.0	1.75	344	0.110
P6KE300	270	330	1.0	243	5.0	1.40	430	0.110
P6KE300A	285	315	1.0	256	5.0	1.45	414	0.110
P6KE350	315	385	1.0	284	5.0	1.20	504	0.110
P6KE350A	332	368	1.0	300	5.0	1.25	482	0.110
P6KE400	360	440	1.0	324	5.0	1.05	574	0.110
P6KE400A	380	420	1.0	342	5.0	1.10	548	0.110
P6KE440	396	484	1.0	356	5.0	0.95	631	0.110
P6KE440A	418	462	1.0	376	5.0	1.00	602	0.110

Table Symbols:

- V<sub>BR</sub> measured after I<sub>T</sub> applied for 300μS, I<sub>T</sub>=square wave pulse or equivalent
- Surge current waveform per Figure 3 and derate per Figure 2.
- For Bidirectional types with V<sub>R</sub> of 10 Volts and less, the I<sub>D</sub> limit is doubled
- All Terms and Symbols are consistent with ANSI/IEEE C62.35

I<sub>D</sub> - Reverse Leakage Current  
 I<sub>PPM</sub> - Maximum Peak Pulse Current  
 I<sub>T</sub> - Test Current (To Determine V<sub>BR</sub>)  
 mA - Milliampere  
 Max. - Maximum  
 Min - Minimum

V<sub>BR</sub> - Breakdown Voltage  
 V<sub>C</sub> - Clamping Voltage  
 V<sub>WM</sub> - Reverse Standoff Voltage  
 % - Per Cent  
 °C - Degrees Celsius