

# Temperature Controller E5C2

## DIN-sized (48 x 48 mm) Temperature Controller with analogue setting



- Compact, price effective Temperature Controller.
- Incorporates proportional control and reset adjustment function.
- Consecutive mounting possible using mounting adapter.
- Incorporates a plug-in socket, allowing DIN-track and flush mounting.



For the most recent information on models that have been certified for safety standards, refer to your OMRON website.

Refer to *Safety Precautions for All Temperature Controllers*.

## Model Number Structure

### Model Number Legend

E5C2-

1 2 3 4 5

#### 1. Control Outputs

R: Relay

#### 2. Control Method

20: ON-OFF control

40: Proportional control

#### 3. Input

K: K-type thermocouple

J: J-type thermocouple

P-D: Platinum resistance thermometer (Pt100)

G: Thermistor with replaceable element

#### 4. Power supply voltage:

AC100-240: 100 to 240 VAC

#### 5. Temperature range

E.g. "0-200": 0 to 200 °C

**Note:** A functional explanation is shown in the below table: But models are not necessarily available for all possible combinations. Refer to *Ordering Information* when ordering.

#### Examples

- Relay control output, ON/OFF control, K-type thermocouple input, 100 to 240 VAC power supply voltage, 0 to 200 °C: E5C2-R20K AC100-240 0-200
- Relay control output, proportional control, Relay control output, K-type thermocouple, 100 to 240 VAC power supply voltage, 0 to 800 °C: E5C2-R40K AC100-240 0-800

## Ordering Information

### Temperature Controllers

Input					Thermocouple						Resistance Thermometer						Thermistor						
					K (CA) Chromel vs. alumel			J (IC) Iron vs. constantan			Platinum resistance thermometer Pt100						Thermistor (replaceable element)						
Setting method	Indication method	Control mode	Output	Minimum scale division (°C)	Standard scale (°C)																		
					200	400	600	800	1,000	1,200	200	300	400	50	50	100	200	300	400	100	200	300	
Analogue setting	No indication	ON/OFF	Relay	Model	E5C2-R20K							E5C2-R20J							E5C2-R20P-D				E5C2-R20G
		Proportional (P)	Relay	Model	E5C2-R40K																		

**Note:** When placing an order, specify the temperature range in addition to the model number.

## Standard Models (Power supply: 100-240 VAC)

Input		Indication method	Control method	No indication		
				ON/OFF	Proportional (P)	
Input/ standard scale (°C)	Thermocouple	K (CA) Chromel vs. Alumel	Output	Relay		
			0 to 200°C	E5C2-R20K AC100-240 0-200	E5C2-R40K AC100-240 0-200	
			0 to 300°C	-	E5C2-R40K AC100-240 0-300	
			0 to 400°C	E5C2-R20K AC100-240 0-400	E5C2-R40K AC100-240 0-400	
			0 to 600°C	E5C2-R20K AC100-240 0-600	E5C2-R40K AC100-240 0-600	
			0 to 800°C	E5C2-R20K AC100-240 0-800	E5C2-R40K AC100-240 0-800	
			0 to 1000°C	E5C2-R20K AC100-240 0-1000	-	
			0 to 1200°C	E5C2-R20K AC100-240 0-1200	-	
			J (IC) Iron versus Constantan	0 to 200°C	E5C2-R20J AC100-240 0-200	-
				0 to 300°C	E5C2-R20J AC100-240 0-300	-
				0 to 400°C	E5C2-R20J AC100-240 0-400	-
	Resistance thermometer	Platinum resistance thermometer	-50 to 50°C	E5C2-R20P-D AC100-240 -50-50	-	
			0 to 50°C	E5C2-R20P-D AC100-240 0-50	-	
			0 to 100°C	E5C2-R20P-D AC100-240 0-100	-	
			0 to 200°C	E5C2-R20P-D AC100-240 0-200	-	
			0 to 300°C	E5C2-R20P-D AC100-240 0-300	-	
0 to 400°C			E5C2-R20P-D AC100-240 0-400	-		
Thermistor	THE (replaceable element)	0 to 100°C	E5C2-R20G AC100-240 0-100	-		
		100 to 200°C	E5C2-R20G AC100-240 100-200	-		
		150 to 300°C	E5C2-R20G AC100-240 150-300	-		

## ■ Accessories (Order Separately)

### Sockets

Name	Model
Front Connecting Socket	P2CF-08
Back Connecting Socket	P3G-08
Front Connecting Socket with Finger Protection	P2CF-08-E
Protective Cover (for finger protection)	Y92A-48G

### Protective Cover

Type	Model
Hard Protective Cover	Y92A-48B

# Specifications

## ■ Ratings

<b>Supply voltage</b>	100 to 240 VAC 50/60 Hz
<b>Operating voltage range</b>	90% to 110% of rated supply voltage
<b>Power consumption</b>	Approx. 3.6 VA
<b>Input</b>	Thermocouple (with sensor burnout detection circuit), platinum resistance thermometer, or thermistor with replaceable element
<b>Control method</b>	ON/OFF or proportional control
<b>Setting method</b>	Analog setting
<b>Indication method</b>	No indication
<b>Control output</b>	Relay output: SPDT, 3 A at 250 VAC, resistive load (switching capacity: 330 VA)
<b>Ambient operating temperature</b>	-10°C to 55°C (with no icing or condensation)
<b>Ambient operating humidity</b>	45% to 85%

**Note: 1.** Do not use an inverter output as the power supply. (Refer to *Safety Precautions for All Temperature Controllers.*)

## ■ Characteristics

<b>Setting accuracy</b>	±2% FS max.
<b>Hysteresis</b>	Approx. 0.5% FS (fixed)
<b>Proportional band</b>	3% FS (fixed)
<b>Control period</b>	Approx. 20 s
<b>Reset range</b>	5 ±1% FS min. (See note 1.)
<b>Insulation resistance</b>	20 MΩ min. (at 500 VDC)
<b>Dielectric strength</b>	2,000 VAC, 50/60 Hz for 1 min between charged terminals and uncharged metallic parts
<b>Vibration resistance</b>	Malfunction: 10 to 55 Hz, 0.15-mm single amplitude for 10 min each in X, Y, and Z directions Destruction: 16.7 Hz, 2-mm double amplitude for 2 hrs each in X, Y, and Z directions
<b>Shock resistance</b>	Malfunction: 147 m/s <sup>2</sup> , 3 times each in 6 directions Destruction: 294 m/s <sup>2</sup> , 3 times each in 6 directions
<b>Life expectancy</b>	Electrical: 100,000 operations min. (3 A at 110 VAC, resistive load)
<b>Weight</b>	Approx. 100 g (with flush-mounting adapter)
<b>Degree of protection</b>	Front panel: IEC standard IP40 (See note 2.) Terminals: IEC standard IP00
<b>Applicable Socket</b>	P2CF-08 (order separately), P3G-08 (order separately)
<b>Applicable Protective Cover</b>	Y92A-48B (order separately)

- Note: 1.** No reset function is incorporated by any E5C2 model with ON/OFF control.  
The reset function is used to correct offset for proportional control. If there is an offset below the set value, turn the reset adjustment clockwise.
- 2.** A special Watertight Cover is used to achieve this degree of protection (IP66, NEMA4). Refer to Y92A-□□N.

## ■ Connections

### Connecting the Input

- Connect a thermocouple, the E52-THE□ Thermistor (replaceable element) or a platinum resistance thermometer to terminals 1 (positive) and 2 (negative) on the E5C2 as shown in the following illustration.

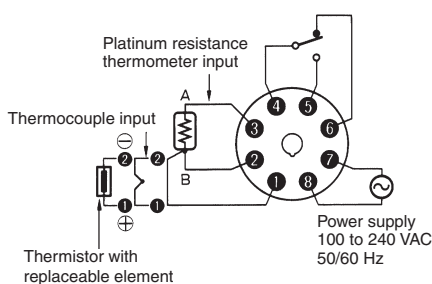

- On the E52-□□1D, the lead wires are thermocouple element wires, making them difficult to solder because solder will not stick to them easily. Remove the crimp terminal and polish the ends before attempting to solder them.

### Output

- If the load circuit is a heating control system, be sure to connect the load to terminals 4 and 5. If the load circuit is a cooling control system, be sure to connect the load to terminals 4 and 6.
- We recommend using an external relay to extend the electrical life of internal relays when driving a large capacity load. This is particularly important when the output relay is switched frequently (e.g., with proportional control).

### Power Supply

- If a single power supply is used for the E5C2 and the load, the supply voltage of the power supply may vary greatly when the load is open or closed if the capacity of the power supply is not large enough. Make sure that the capacity of the power supply is large enough so that the supply voltage range will be always from 90% to 110% of the rated supply voltage.
- The E5C2 operates at either 50 or 60 Hz.

# Nomenclature

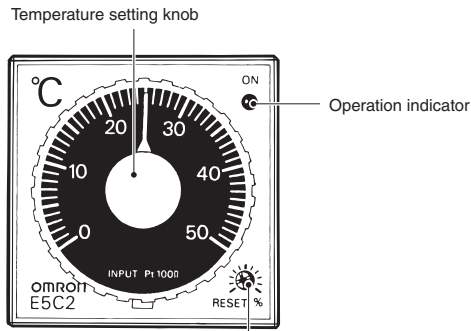

RESET adjustment shaft  
 No reset function is incorporated by any  
 E5C2 model with ON/OFF control.

## Operation Indicator

Indicator		Output	
		NO contacts (4 and 5)	NC contacts (4 to 6)
Red	Lit	ON	OFF
	Not lit	OFF	ON

# Dimensions

Note: All units are in millimeters unless otherwise indicated.

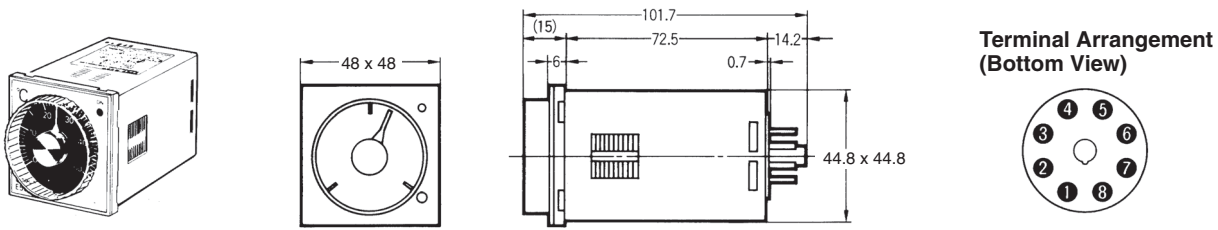

## Dimensions with Flush-mounting Adapter (Accessory), and Back Connecting Socket (Sold Separately)

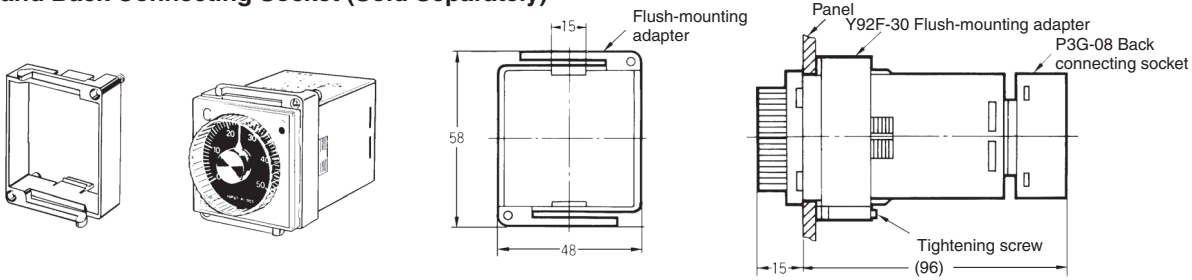

### Panel Cutout

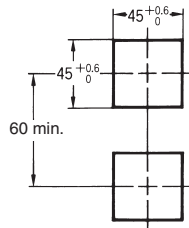

### Side-by-side Mounting of N Controllers

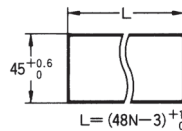

Qty.	2	3	4	5	6
L	93 <sup>+1</sup> <sub>0</sub>	141 <sup>+1</sup> <sub>0</sub>	189 <sup>+1</sup> <sub>0</sub>	237 <sup>+1</sup> <sub>0</sub>	285 <sup>+1</sup> <sub>0</sub>

- Note: 1. Recommended panel thickness is 1 to 4 mm.  
2. Close side-by-side mounting is possible (in a single direction).

## Accessories (Order Separately)

### Connection Sockets

#### P2CF-08 Front Connecting Socket

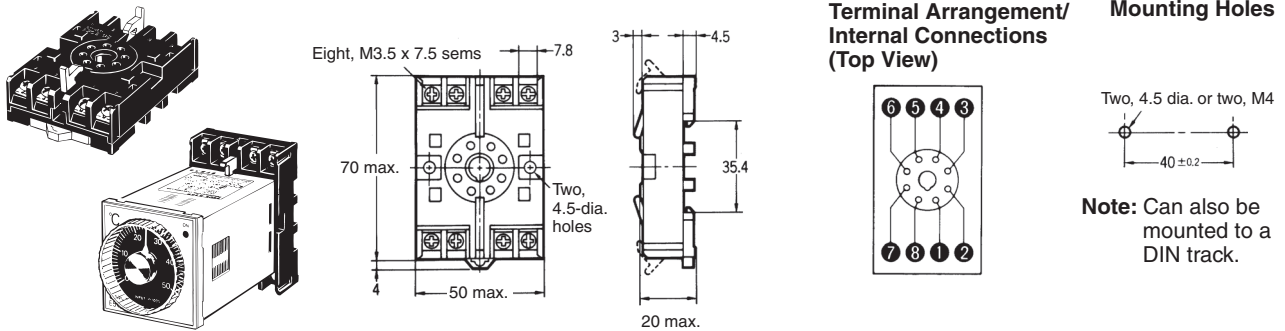

Note: A finger-protection model (P2CF-08-E) is also available.

#### P3G-08 Back Connecting Socket (for Flush Mounting)

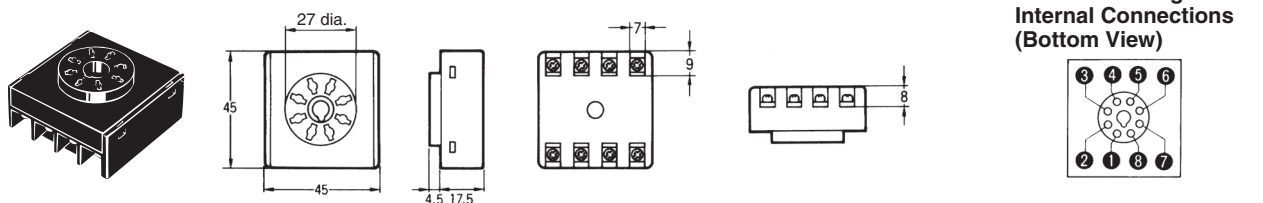

Note: A Protective Cover for finger protection (Y92A-48G) is also available.

---

## Hard Protective Cover

A Hard Protective Cover (Y92A-48B) is available. It can be used in the following cases.

- To protect the setting section, against dust and dirt
- To prevent accidentally changing settings by touching the front of the Controller.
- To protect the Controller from water drips

<b>Appearance</b>	
<b>Model</b>	Y92A-48B

## Applicable Thermistor

Connect a Thermistor with a replaceable element (E52-THE5A, E52-THE6D, or E52-THE6F) to the E5C2-R20G. Refer to *E52* for details.

# Safety Precautions

Refer to *Safety Precautions for All Temperature Controllers*.

## ■ Correct Use

### Mounting

#### Track Mounting (E5C2 with P2CF-08)

When mounting two or more E5C2 models with track-mounting sockets, leave a space of approximately 20 mm on both sides of the sockets where hooks are located.

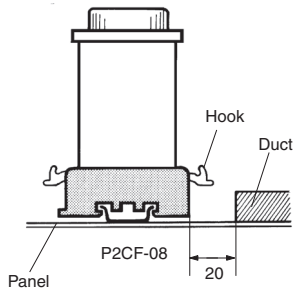

#### Flush Mounting

Insert E5C2 into the square hole of the panel and insert an adapter from the back so that there will be no space between E5C2 and the panel. Then, secure the E5C2 with a screw.

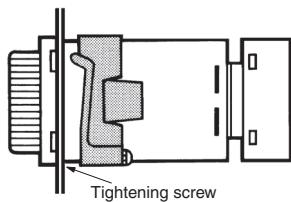

The P3G-08 can be wired in the same way as the P2CF-08.

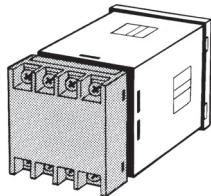

### Dismounting

If flush mounted, loosen the screw of the adapter and disengage the hooks for dismounting.

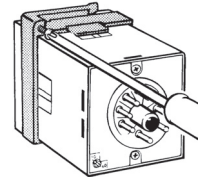

### Temperature Setting

Do not turn the temperature setting knob of the E5C2 with excessive force, otherwise the stopper of the knob may break.

### Others

- Do not remove the housing of the E5C2, otherwise the housing may break.
- To clean the surface of the E5C2, use a soft cloth wet with neutral detergent or alcohol. Do not use any organic solvent, such as paint thinner or benzene, strong acid or strong alkali to clean the surface of the E5C2, otherwise the surface of the E5C2 will become damaged.

ALL DIMENSIONS SHOWN ARE IN MILLIMETERS.

To convert millimeters into inches, multiply by 0.03937. To convert grams into ounces, multiply by 0.03527.

In the interest of product improvement, specifications are subject to change without notice.

# Terms and Conditions Agreement

---

## **Read and understand this catalog.**

Please read and understand this catalog before purchasing the products. Please consult your OMRON representative if you have any questions or comments.

## **Warranties.**

- (a) Exclusive Warranty. Omron's exclusive warranty is that the Products will be free from defects in materials and workmanship for a period of twelve months from the date of sale by Omron (or such other period expressed in writing by Omron). Omron disclaims all other warranties, express or implied.
- (b) Limitations. OMRON MAKES NO WARRANTY OR REPRESENTATION, EXPRESS OR IMPLIED, ABOUT NON-INFRINGEMENT, MERCHANTABILITY OR FITNESS FOR A PARTICULAR PURPOSE OF THE PRODUCTS. BUYER ACKNOWLEDGES THAT IT ALONE HAS DETERMINED THAT THE PRODUCTS WILL SUITABLY MEET THE REQUIREMENTS OF THEIR INTENDED USE.

Omron further disclaims all warranties and responsibility of any type for claims or expenses based on infringement by the Products or otherwise of any intellectual property right. (c) Buyer Remedy. Omron's sole obligation hereunder shall be, at Omron's election, to (i) replace (in the form originally shipped with Buyer responsible for labor charges for removal or replacement thereof) the non-complying Product, (ii) repair the non-complying Product, or (iii) repay or credit Buyer an amount equal to the purchase price of the non-complying Product; provided that in no event shall Omron be responsible for warranty, repair, indemnity or any other claims or expenses regarding the Products unless Omron's analysis confirms that the Products were properly handled, stored, installed and maintained and not subject to contamination, abuse, misuse or inappropriate modification. Return of any Products by Buyer must be approved in writing by Omron before shipment. Omron Companies shall not be liable for the suitability or unsuitability or the results from the use of Products in combination with any electrical or electronic components, circuits, system assemblies or any other materials or substances or environments. Any advice, recommendations or information given orally or in writing, are not to be construed as an amendment or addition to the above warranty.

See <http://www.omron.com/global/> or contact your Omron representative for published information.

## **Limitation on Liability; Etc.**

OMRON COMPANIES SHALL NOT BE LIABLE FOR SPECIAL, INDIRECT, INCIDENTAL, OR CONSEQUENTIAL DAMAGES, LOSS OF PROFITS OR PRODUCTION OR COMMERCIAL LOSS IN ANY WAY CONNECTED WITH THE PRODUCTS, WHETHER SUCH CLAIM IS BASED IN CONTRACT, WARRANTY, NEGLIGENCE OR STRICT LIABILITY.

Further, in no event shall liability of Omron Companies exceed the individual price of the Product on which liability is asserted.

## **Suitability of Use.**

Omron Companies shall not be responsible for conformity with any standards, codes or regulations which apply to the combination of the Product in the Buyer's application or use of the Product. At Buyer's request, Omron will provide applicable third party certification documents identifying ratings and limitations of use which apply to the Product. This information by itself is not sufficient for a complete determination of the suitability of the Product in combination with the end product, machine, system, or other application or use. Buyer shall be solely responsible for determining appropriateness of the particular Product with respect to Buyer's application, product or system. Buyer shall take application responsibility in all cases.

NEVER USE THE PRODUCT FOR AN APPLICATION INVOLVING SERIOUS RISK TO LIFE OR PROPERTY OR IN LARGE QUANTITIES WITHOUT ENSURING THAT THE SYSTEM AS A WHOLE HAS BEEN DESIGNED TO ADDRESS THE RISKS, AND THAT THE OMRON PRODUCT(S) IS PROPERLY RATED AND INSTALLED FOR THE INTENDED USE WITHIN THE OVERALL EQUIPMENT OR SYSTEM.

## **Programmable Products.**

Omron Companies shall not be responsible for the user's programming of a programmable Product, or any consequence thereof.

## **Performance Data.**

Data presented in Omron Company websites, catalogs and other materials is provided as a guide for the user in determining suitability and does not constitute a warranty. It may represent the result of Omron's test conditions, and the user must correlate it to actual application requirements. Actual performance is subject to the Omron's Warranty and Limitations of Liability.

## **Change in Specifications.**

Product specifications and accessories may be changed at any time based on improvements and other reasons. It is our practice to change part numbers when published ratings or features are changed, or when significant construction changes are made. However, some specifications of the Product may be changed without any notice. When in doubt, special part numbers may be assigned to fix or establish key specifications for your application. Please consult with your Omron's representative at any time to confirm actual specifications of purchased Product.

## **Errors and Omissions.**

Information presented by Omron Companies has been checked and is believed to be accurate; however, no responsibility is assumed for clerical, typographical or proofreading errors or omissions.