

TO-220-3L/TO-220F Plastic-Encapsulate Diodes

MUR1060CT、MURF1060CT SUPER FAST RECOVER RECTIFIER

MAIN CHARACTERISTICS

I_O	10A
V_{RRM}	600 V
T_j	150 °C
$V_{F(typ)}$	1.3V (@ $T_j=125^{\circ}C$)

FEATURES

- Ultrafast 35ns Recovery Times
- High Voltage Capability to 600V
- Low Reverse Leakage Current

MARKING

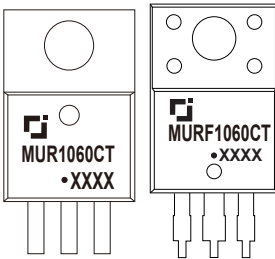

MUR(F)1060CT = Device code
 Solid dot = Green molding compound device
 if none, the normal device
 XXXX = Code

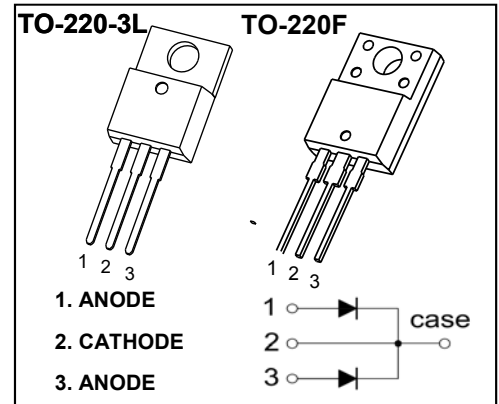

MAXIMUM RATINGS ($T_a=25^{\circ}C$ unless otherwise noted)

Symbol	Parameter	MUR		Unit
		1060CT	F1060CT	
V_{RRM}	Peak repetitive reverse voltage	600		V
V_{RWM}	Working peak reverse voltage			
V_R	DC blocking voltage			
$V_{R(RMS)}$	RMS reverse voltage	420		V
I_O	Average rectified output current@ Per leg	5		A
	Average rectified output current@ Total device	10		A
I_{FSM}	Non-Repetitive peak forward surge current 8.3ms half sine wave	70		A
P_D	Power dissipation	2		W
$R_{\theta JA}$	Thermal resistance from junction to ambient	62.5		°C/W
T_j	Operating Junction Temperature Range	-55 ~ +150		°C
T_{stg}	Storage Temperature Range	-55 ~ +150		°C

ELECTRICAL CHARACTERISTICS ($T_a=25^{\circ}C$ unless otherwise specified)

Parameter	Symbol	Test conditions	Min	Typ	Max	Unit
Reverse voltage	$V_{(BR)}$	$I_R=100\mu A$	600			V
Reverse current	I_R	$V_R=600V$	$T_j = 25^{\circ}C$	0.5	2	μA
			$T_j = 125^{\circ}C$	2.0		μA
Forward voltage	V_F	$I_F=5.0A$	$T_j = 25^{\circ}C$	1.5	1.7	V
			$T_j = 125^{\circ}C$	1.3		V
Typical total capacitance	C_{tot}	$V_R=4.0V, f=1MHz$		14		pF
Reverse recovery time	t_{rr}	$I_F=0.5A, I_R=1A, I_{rr}=0.25A$			35	ns

Typical Characteristics

Forward Characteristics

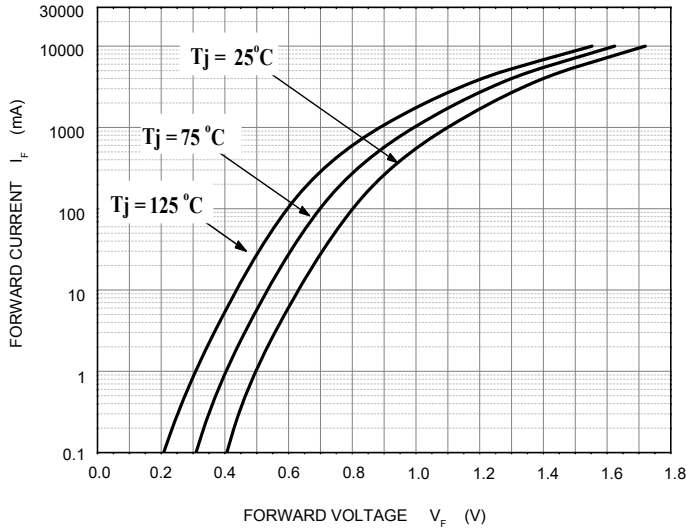

Reverse Characteristics

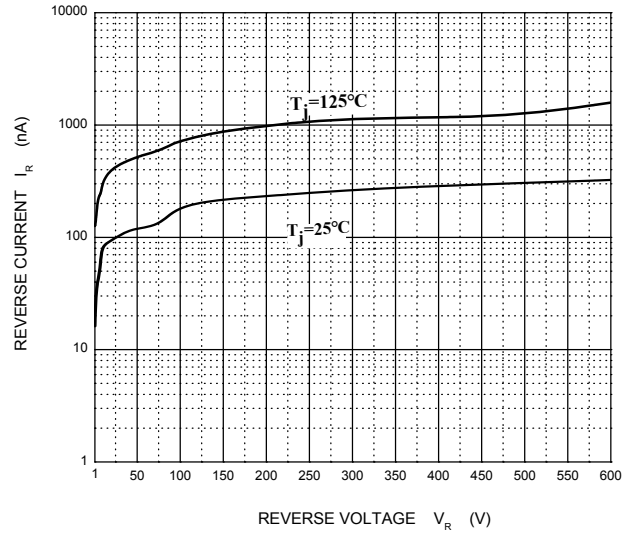

Capacitance Characteristics

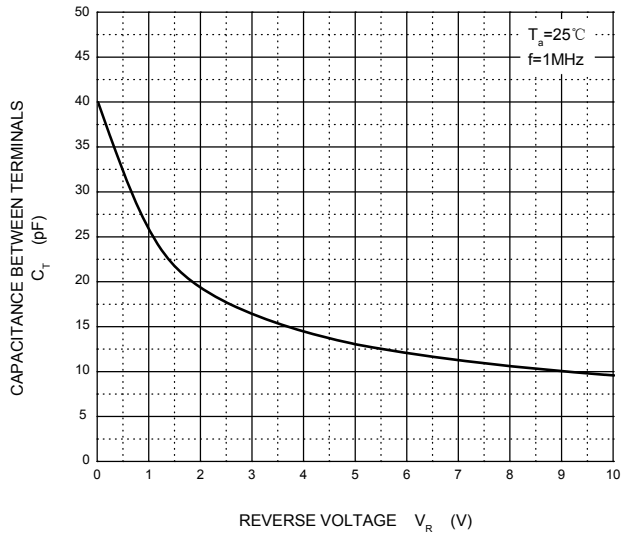

Power Derating Curve

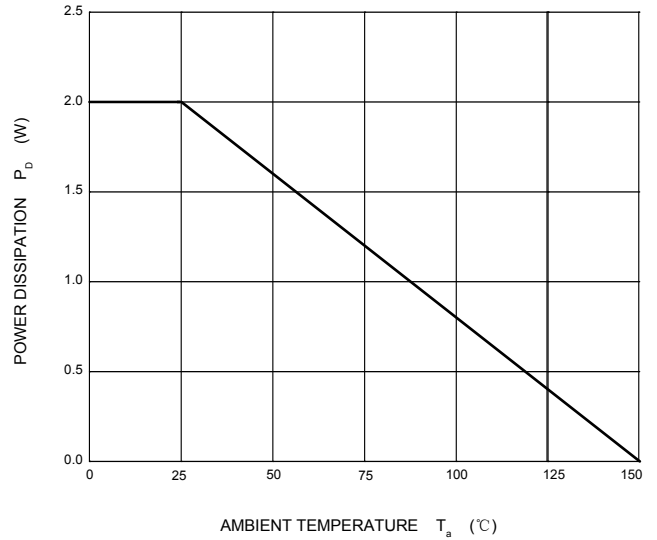
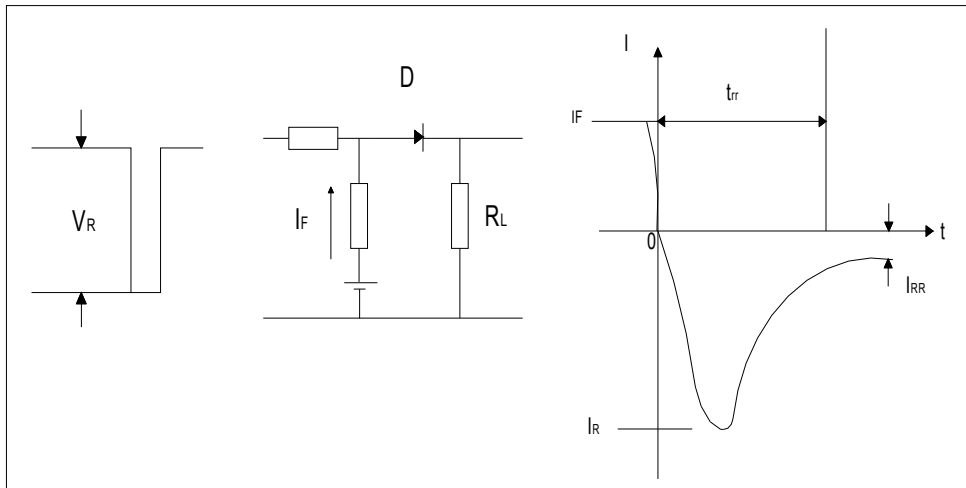

Diagram of circuit and Testing wave form of reverse recovery time



TO-220-3L Package Outline Dimensions



Symbol	Dimensions In Millimeters		Dimensions In Inches	
	Min	Max	Min	Max
A	4.450	4.750	0.175	0.187
A1	2.520	2.820	0.099	0.111
b	0.710	0.910	0.028	0.036
b1	1.170	1.370	0.046	0.054
c	0.300	0.500	0.012	0.020
c1	1.170	1.370	0.046	0.054
D	9.830	10.330	0.387	0.407
E	8.500	8.900	0.335	0.350
E1	12.050	12.650	0.474	0.498
e	2.540 TYP		0.100 TYP	
e1	4.900	5.200	0.192	0.205
F	2.540	2.940	0.100	0.116
h	0.100 TYP		0.004 TYP	
L	13.300	13.800	0.523	0.543
L1	3.540	3.940	0.139	0.155
Φ	3.735	3.935	0.147	0.155

TO-220F Package Outline Dimensions



Symbol	Dimensions In Millimeters		Dimensions In Inches	
	Min.	Max.	Min.	Max.
A	4.300	4.700	0.169	0.185
A1	1.300 REF.		0.051 REF.	
A2	2.800	3.200	0.110	0.126
A3	2.500	2.900	0.098	0.114
b	0.500	0.750	0.020	0.030
b1	1.100	1.350	0.043	0.053
b2	1.500	1.750	0.059	0.069
c	0.500	0.750	0.020	0.030
D	9.960	10.360	0.392	0.408
E	14.800	15.200	0.583	0.598
e	2.540 TYP.		0.100 TYP.	
F	2.700 REF.		0.106 REF.	
Φ	3.500 REF.		0.138 REF.	
h	0.000	0.300	0.000	0.012
h1	0.800 REF.		0.031 REF.	
h2	0.500 REF.		0.020 REF.	
L	28.000	28.400	1.102	1.118
L1	1.700	1.900	0.067	0.075
L2	1.900	2.100	0.075	0.083