

0.5mm Pitch, 0.9mm Height, FPC/FFC Connectors

FH19C Series/FH19SC Series

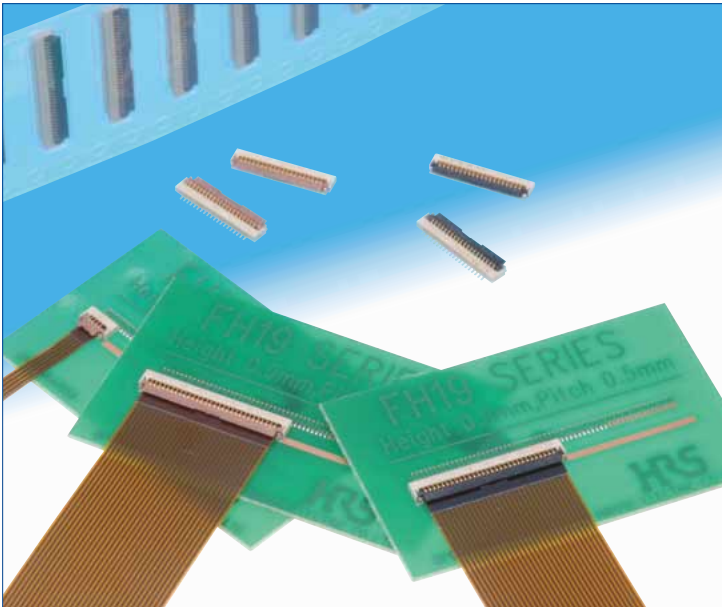

FH19C – FPC/FFC thickness : 0.2 ± 0.03 mm

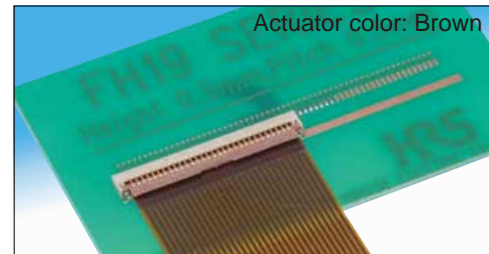

FH19SC – FPC/FFC thickness : 0.3 ± 0.03 mm

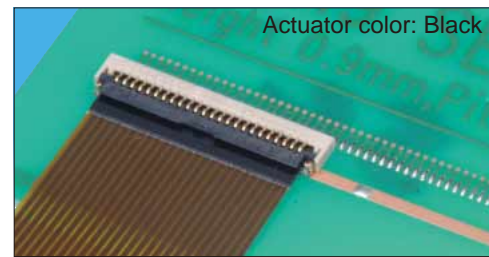

Features

1. Low-profile 0.5mm pitch FPC/FFC Connectors

Miniaturization of portable equipment and personal mobile devices has created increased demand for a low profile, high density, and high reliability connectors.

*The design of this connector has been made thinner and smaller, with a height of 0.9mm and width of 3mm.

*PCB footprint: Reduced approximately 48% (as compared with Hirose Electric's 0.5mm pitch FH12 Series connectors)

*Connector weight: Reduced approximately 78% (as compared with Hirose Electric's 0.5mm pitch FH12 Series connectors)

2. Conductive traces on the PCB can run under the connector

All bottom surface of the connector is solid, without any exposure of the contact.

3. Proven Flip-Lock Actuator System assures easy and reliable operation

Rotating actuator permits easy insertion and reliable connection with the FPC & FFC.

Tactile sensation confirms complete mechanical locking of the actuator and the electrical connection.

4. Accepts 0.2mm & 0.3mm thick FPC/FFC

No exposed contacts on the bottom of the connector. The connector will also terminate with 0.2mm thick Flat Flexible Cable (FFC).

5. Board placement with automatic equipment

Flat upper surface and tape and reel packaging facilitate vacuum pick-up and placement. Standard reel packaging contains 5000 connectors.

6. Wide range of contact counts

The contact positions available range from 4 to 50.

7. Satisfies Halogen-free requirements

All materials and substances used in this product comply with the Halogen-free standards.

* Defined according to IEC61249-2-21

Br : 900ppm max, Cl : 900ppm max, Br+Cl : 1,500ppm max

● 0.9mm high (30 pos. shown)

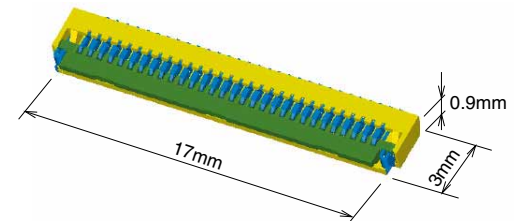

● Can be mounted over conductive traces

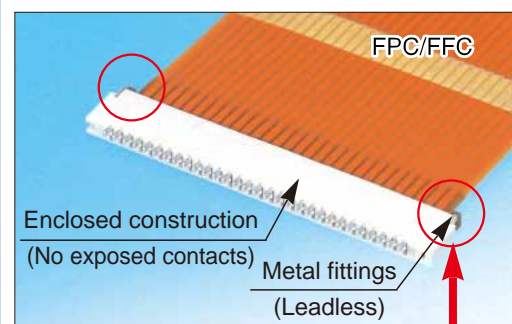

● Metal Fittings (Leadless Type)

No protrusions on the sides allows close side-by-side board placement.



● Actuator Temporary Hold Mechanism

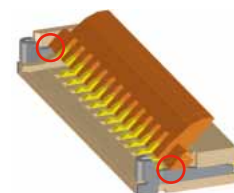

Actuator stays open during insertion of the FPC/FFC.

Product Specifications

Rating	Current rating 0.5A (Note 1)	Operating temperature range -55°C to +85°C (Note 2)	Storage temperature range -10°C to +50°C (Note 3)
	Voltage rating 50V AC	Operating humidity range Relative humidity 90% max. (No condensation)	Storage humidity range Relative humidity 90% max. (No condensation)

Recommended FPC, FFC	FH19C Series	Thickness : = 0.2 ± 0.03mm Gold plated
	FH19SC Series	Thickness : = 0.3 ± 0.03mm Gold plated

Item	Specification	Conditions
1. Insulation resistance	500MΩ min.	100V DC
2. Withstanding voltage	No flashover or insulation breakdown	150V AC/1 minute
3. Contact resistance	100mΩ max. *Including FPC/FFC conductor resistance	1mA
4. Durability (insertion/ withdrawal)	Contact resistance : 100mΩ max. No damage, cracks, or parts dislocation.	20 cycles
5. Vibration	No electrical discontinuity of 1μs or more. Contact resistance : 100mΩ max. No damage, cracks, or parts dislocation.	Frequency : 10 to 55Hz, single amplitude of 0.75mm, 10 cycles in each of the 3 directions
6. Shock	No electrical discontinuity of 1μs. min. Contact resistance : 100mΩ max. No damage, cracks, or parts dislocation.	Acceleration of 981m/s ² , 6ms duration, sine half- wave waveform, 3 cycles in each of the 3 axis.
7. Humidity (Steady state)	Contact resistance : 100mΩ max. Insulation resistance : 100MΩ min. No damage, cracks, or parts dislocation.	96 hours at temperature of 40°C and humidity of 90 to 95%
8. Temperature cycle	Contact resistance : 100mΩ max. Insulation resistance : 100MΩ min. No damage, cracks, or parts dislocation.	Temperature : -55°C → +15°C to +35°C → +85°C → +15°C to +35°C Time : 30 → 2 to 3 → 30 → 2 to 3 (Minutes) 5 cycles
9. Resistance to soldering heat	No deformation of components affecting performance.	Reflow : At the recommended temperature profile Manual soldering : 350°C±5°C for 5 seconds

Note 1 : When passing the current through all of the contacts, use 70% of the current rating.

Note 2 : Includes temperature rise caused by current flow.

Note 3 : The term "storage" refers to products stored for long period of time prior to mounting and use. Operating Temperature Range and Humidity range covers non- conducting condition of installed connectors in storage, shipment or during transportation. Information

Materials / Finish

Part	Material	Finish	Remarks
Insulator	LCP	Color: Beige	UL94V-0
		Color: Brown (FH19C Series) Color: Black (FH19SC Series)	
Contacts	Phosphor bronze	Gold plated	—
Metal fittings	Phosphor bronze	Pure tin reflow plated	—

Product Number Structure

Refer to the chart below when determining the product specifications from the product number.

Please select from the product numbers listed in this catalog when placing orders.

FH 19 C - 30S - 0.5 SH (10)

①
②
③
④
⑤
⑥
⑦

① Series name : FH	⑤ Contact pitch : 0.5mm
② Series No. : 19	⑥ Terminal type SH : SMT horizontal mounting type
③ C : FPC thickness : 0.2mm SC : FPC/FFC thickness : 0.3mm	⑦ Material and plating specifications : FH19C : (10)...Gold plating with nickel barrier 5,000pieces/reel (99)...Gold plating with nickel barrier 500pieces/reel FH19SC : (09)...Gold plating with nickel barrier 5,000pieces/reel (99)...Gold plating with nickel barrier 500pieces/reel
④ No. of contacts : 4 to 50	

Connector Dimension

[FH19C Series]

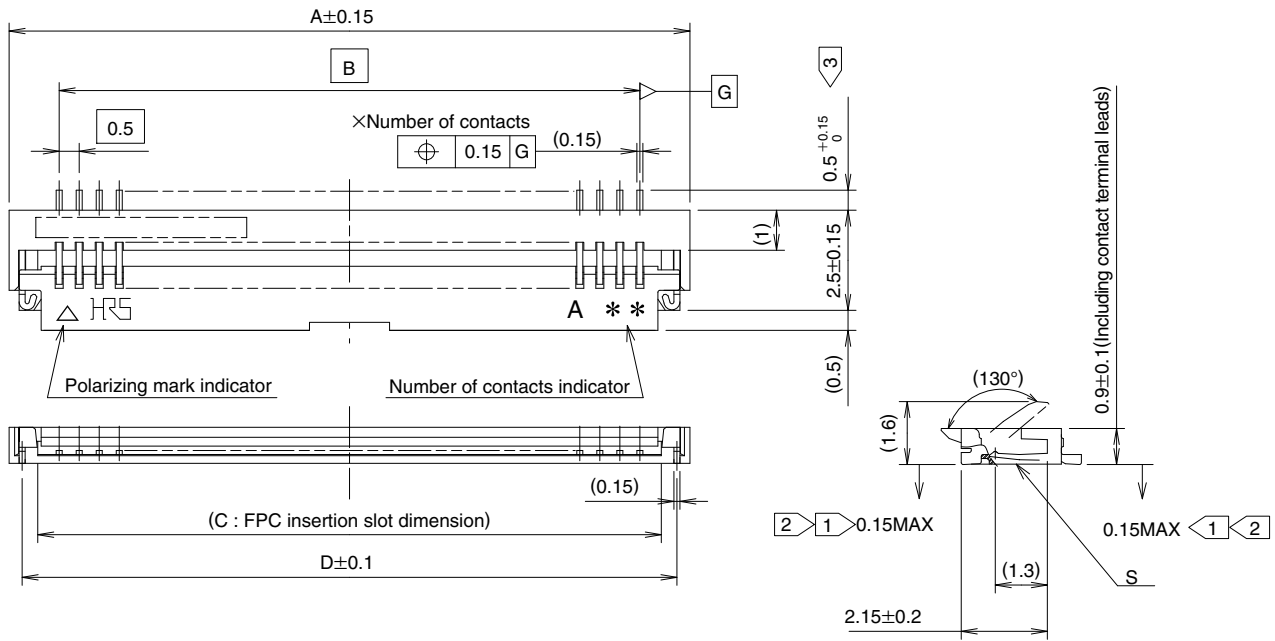

- Notes
- ① The coplanarity of each terminal lead and metal fitting is within 0.1mm.
 - ② The contact terminal lead position indicates the dimension from the bottom surface of the insulator body.
 - ③ Difference between terminal contact to be max. 0.1mm.
 - 4 Packaged on tape and reel only. Check packaging specification.
 - 5 Any discoloration of the plastic compound will NOT AFFECT form, fit or function of the connector.
 - 6 After reflow, the terminal plating may change color, however this does not represent a quality issue.

Unit : mm

Part No.	HRS No.	No. of Contacts	A	B	C	D
FH19C- 4S-0.5SH(**)	580-0410-1 **	4	4	1.5	2.57	3.35
FH19C- 5S-0.5SH(**)	580-0418-3 **	5	4.5	2	3.07	3.85
FH19C- 6S-0.5SH(**)	580-0409-2 **	6	5	2.5	3.57	4.35
FH19C- 7S-0.5SH(**)	580-0411-4 **	7	5.5	3	4.07	4.85
FH19C- 8S-0.5SH(**)	580-0404-9 **	8	6	3.5	4.57	5.35
FH19C- 9S-0.5SH(**)	580-0403-6 **	9	6.5	4	5.07	5.85
FH19C-10S-0.5SH(**)	580-0412-7 **	10	7	4.5	5.57	6.35
FH19C-12S-0.5SH(**)	580-0413-0 **	12	8	5.5	6.57	7.35
FH19C-13S-0.5SH(**)	580-0405-1 **	13	8.5	6	7.07	7.85
FH19C-15S-0.5SH(**)	580-0406-4 **	15	9.5	7	8.07	8.85
FH19C-17S-0.5SH(**)	580-0408-0 **	17	10.5	8	9.07	9.85
FH19C-20S-0.5SH(**)	580-0402-3 **	20	12	9.5	10.57	11.35
FH19C-21S-0.5SH(**)	580-0414-2 **	21	12.5	10	11.07	11.85
FH19C-24S-0.5SH(**)	580-0407-7 **	24	14	11.5	12.57	13.35
FH19C-27S-0.5SH(**)	580-0401-0 **	27	15.5	13	14.07	14.85
FH19C-30S-0.5SH(**)	580-0400-8 **	30	17	14.5	15.57	16.35
FH19C-34S-0.5SH(**)	580-0419-6 **	34	19	16.5	17.57	18.35
FH19C-40S-0.5SH(**)	580-0416-8 **	40	22	19.5	20.57	21.35
FH19C-50S-0.5SH(**)	580-0417-0 **	50	27	24.5	25.57	26.35

Note1 : Embossed tape reel packaging (5,000 pieces/reel, 500 pieces/reel).
Order by number of reels.

[FH19SC Series]

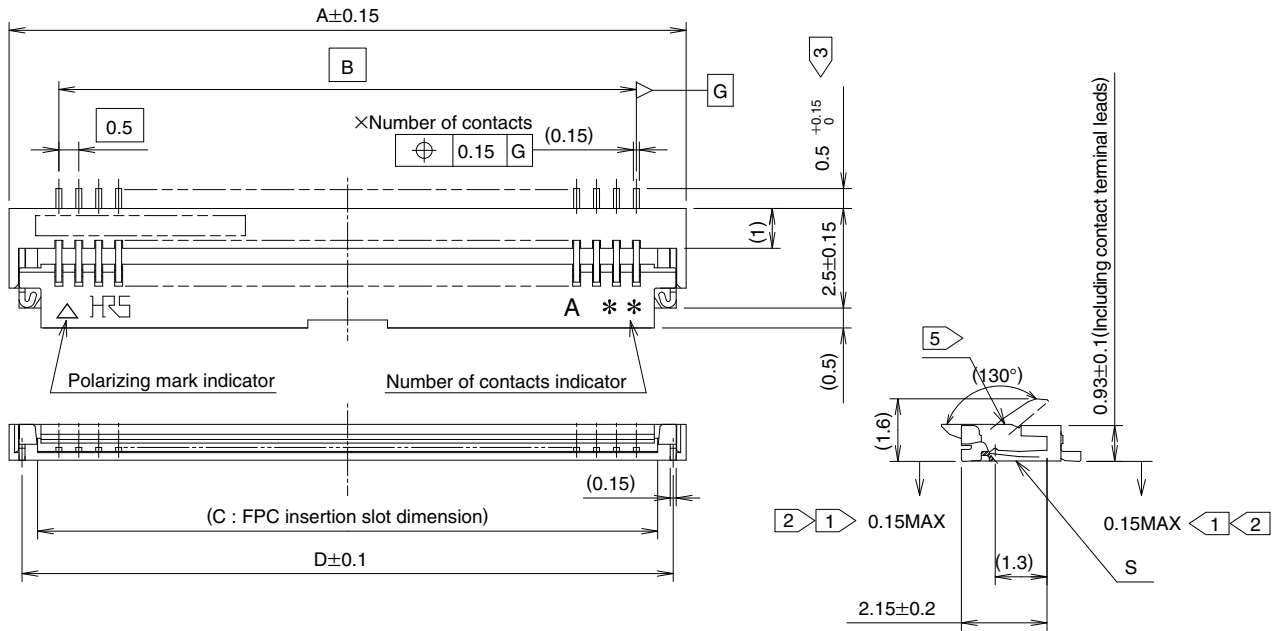

- Notes
- 1 The coplanarity of each terminal lead and metal fitting is within 0.1mm.
 - 2 The contact terminal lead position indicates the dimension from the bottom surface of the insulator body.
 - 3 Difference between terminal contact to be max. 0.1mm.
 - 4 Any discoloration of the plastic compound will NOT AFFECT form, fit or function of the connector.
 - 5 The contacts are protruding. 0.03mm max. from the housing top surface.
 - 6 Packaged on tape and reel only. Check packaging specification.
 - 7 After reflow, the terminal plating may change color, however this does not represent a quality issue.

Unit : mm

Part No.	HRS No.	No. of Contacts	A	B	C	D
FH19SC-12S-0.5SH(**)	580-0512-1 **	12	8	5.5	6.57	7.35
FH19SC-13S-0.5SH(**)	580-0518-8 **	13	8.5	6	7.07	7.85
FH19SC-14S-0.5SH(**)	580-0509-7 **	14	9	6.5	7.57	8.35
FH19SC-15S-0.5SH(**)	580-0503-0 **	15	9.5	7	8.07	8.85
FH19SC-16S-0.5SH(**)	580-0521-2 **	16	10	7.5	8.57	9.35
FH19SC-17S-0.5SH(**)	580-0504-3 **	17	10.5	8	9.07	9.85
FH19SC-18S-0.5SH(**)	580-0519-0 **	18	11	8.5	9.57	10.35
FH19SC-20S-0.5SH(**)	580-0502-8 **	20	12	9.5	10.57	11.35
FH19SC-21S-0.5SH(**)	580-0505-6 **	21	12.5	10	11.07	11.85
FH19SC-22S-0.5SH(**)	580-0506-9 **	22	13	10.5	11.57	12.35
FH19SC-24S-0.5SH(**)	580-0511-9 **	24	14	11.5	12.57	13.35
FH19SC-26S-0.5SH(**)	580-0510-6 **	26	15	12.5	13.57	14.35
FH19SC-27S-0.5SH(**)	580-0516-2 **	27	15.5	13	14.07	14.85
FH19SC-28S-0.5SH(**)	580-0513-4 **	28	16	13.5	14.57	15.35
FH19SC-30S-0.5SH(**)	580-0500-2 **	30	17	14.5	15.57	16.35
FH19SC-32S-0.5SH(**)	580-0514-7 **	32	18	15.5	16.57	17.35

Note1 : Embossed tape reel packaging (5,000 pieces/reel, 500pieces/reel) .
Order by number of reels.

Recommended PCB Land and Metal Mask Dimensions

[Common to FH19C & FH19SC Series]

Recommended metal mask thickness : 0.10mm.

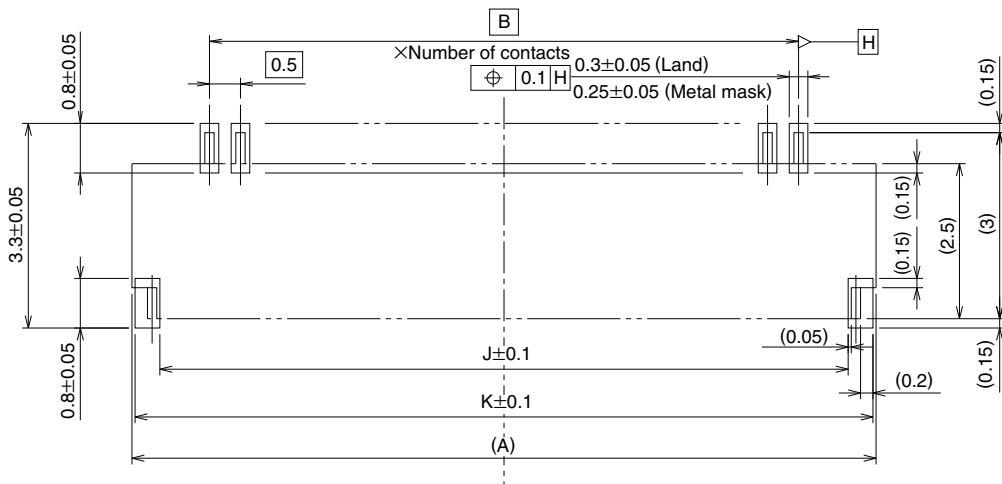

Recommended FPC, FFC Dimensions

[Common to FH19C & FH19SC Series]

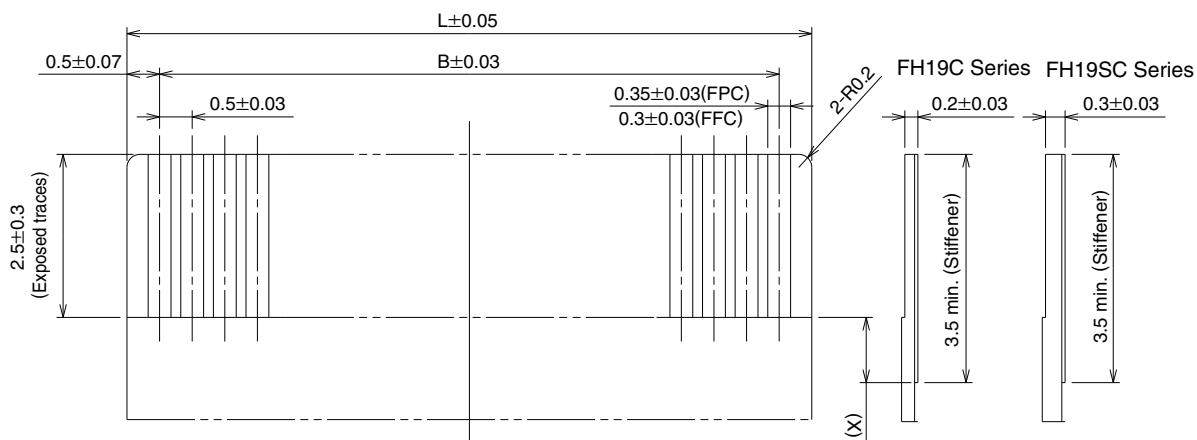

Note 1 : Stiffener dimension should be 3.5mm min., and X dimension should be 0.5mm for improved flexibility of FPC.

Unit : mm

No. of Contacts	A	B	J	K	L
4	4.0	1.5	3.1	3.9	2.5
5	4.5	2.0	3.6	4.4	3.0
6	5.0	2.5	4.1	4.9	3.5
7	5.5	3.0	4.6	5.4	4.0
8	6.0	3.5	5.1	5.9	4.5
9	6.5	4.0	5.6	6.4	5.0
10	7.0	4.5	6.1	6.9	5.5
12	8.0	5.5	7.1	7.9	6.5
13	8.5	6.0	7.6	8.4	7.0
14	9.0	6.5	8.1	8.9	7.5
15	9.5	7.0	8.6	9.4	8.0
16	10.0	7.5	9.1	9.9	8.5
17	10.5	8.0	9.6	10.4	9.0
18	11.0	8.5	10.1	10.9	9.5

Unit : mm

No. of Contacts	A	B	J	K	L
20	12.0	9.5	11.1	11.9	10.5
21	12.5	10.0	11.6	12.4	11.0
22	13.0	10.5	12.1	12.9	11.5
24	14.0	11.5	13.1	13.9	12.5
26	15.0	12.5	14.1	14.9	13.5
27	15.5	13.0	14.6	15.4	14.0
28	16.0	13.5	15.1	15.9	14.5
30	17.0	14.5	16.1	16.9	15.5
32	18.0	15.5	17.1	17.9	16.5
34	19.0	16.5	18.1	18.9	17.5
40	22.0	19.5	21.1	21.9	20.5
50	27.0	24.5	26.1	26.9	25.5

FH19C & FH19SC Series FPC/FFC Construction (Recommended Specifications)

1. Using Single-sided FPC

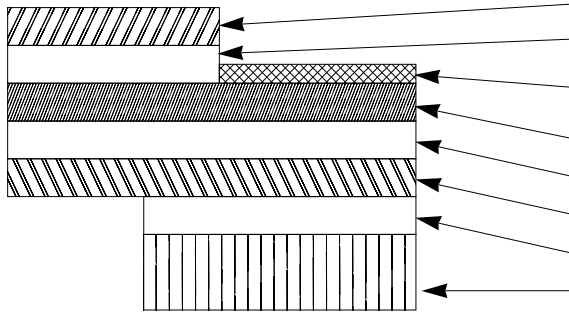

FPC : Flexible Printed Circuit

Material Name	Material	Thickness (μm)	
		FH19C	FH19SC
Covering layer film	Polyimide 1 mil thick	(25)	(25)
Cover adhesive		(25)	(25)
Surface treatment	Nickel under plated 1 to 5μm / Gold plated 0.2μm	3	3
Copper foil	Cu 1oz	35	35
Base adhesive	Thermosetting adhesive	25	25
Base film	Polyimide 1 mil thick	25	25
Reinforcement material adhesive	Thermosetting adhesive	30	30
Stiffener	Polyimide FH19C : 3mil FH19SC : 7mil	75	175
Total		193	293

2. Using Double-sided FPC

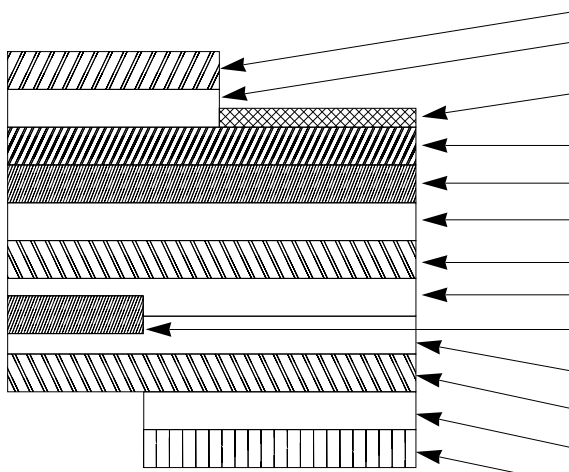

FPC : Flexible Printed Circuit

Material Name	Material	Thickness (μm)	
		FH19C	FH19SC
Covering layer film	Polyimide 1 mil thick	(25)	(25)
Cover adhesive		(25)	(25)
Surface treatment	Nickel under plated 1 to 5μm / Gold plated 0.2μm	3	3
Through-hole copper	Cu	15	15
Copper foil	Cu 1/2oz	18	18
Base adhesive	Thermosetting adhesive	18	18
Base film	Polyimide 1 mil thick	25	25
Base adhesive		18	18
Copper foil	Cu 1/2oz	18	18
Cover adhesive	Thermosetting adhesive	25	25
Covering layer film	Polyimide 1 mil thick	25	25
Reinforcement material adhesive	Thermosetting adhesive	25	50
Stiffener	Polyimide FH19C : 1mil FH19SC : 4mil	25	100
Total		197	297

3. Using FFC (Flexible Flat Cable)

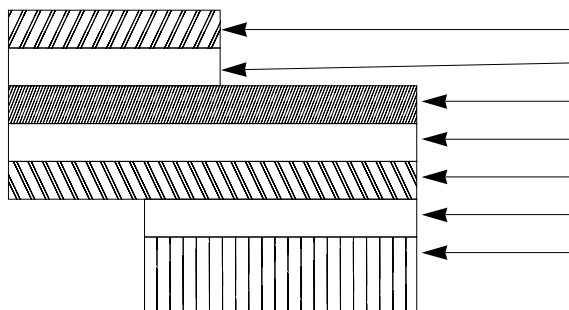

FFC : Flexible Flat Cable

Material Name	Material	Thickness (μm)	
		FH19C	FH19SC
Polyester film		(12)	(12)
Adhesive	Polyester thermoplastic type	(30)	(30)
(Nickel under plated / Gold plated), soft copper film		35	35
Adhesive	Polyester	30	30
Polyester		12	12
Adhesive	Polyester	30	30
Stiffener	Polyester	100	188
Total		207	295

* Practical tolerance of thickness dimension is ±20μm (i.e., 187 to 227μm).

4. Precautions

1. This specification is a recommendation for the construction of the FH19C/FH19SC Series FPC and FFC (t=0.2/0.3±0.03).
2. For details about the construction, please contact the FPC/FFC manufacturers.

■ Packaging Specifications

[Common to FH19C & FH19SC Series]

● Embossed Carrier Tape Dimensions

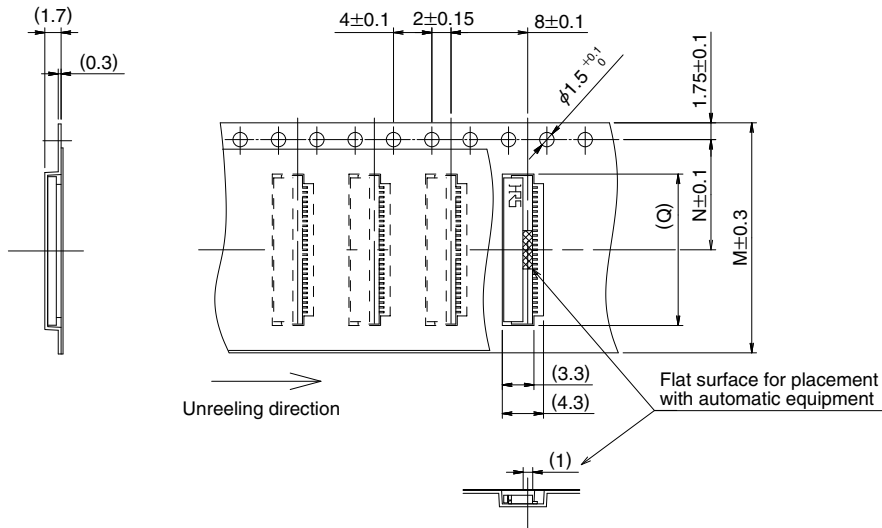

● Reel Dimensions

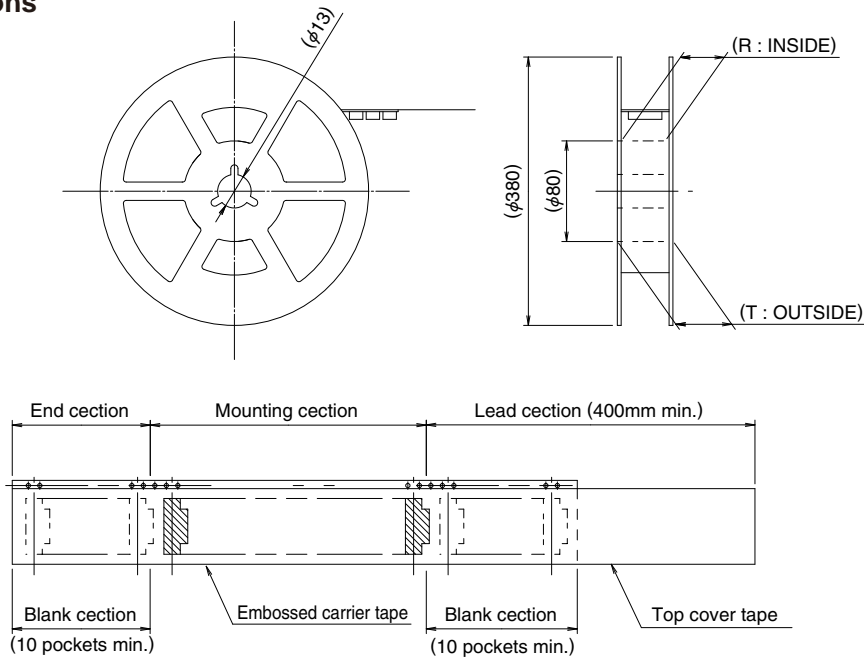

Unit : mm

No. of Contacts	M	N	Q	R	T
4	16	7.5	4.3	17.4	21.4
5	16	7.5	4.8	17.4	21.4
6	16	7.5	5.3	17.4	21.4
7	16	7.5	5.8	17.4	21.4
8	16	7.5	6.3	17.4	21.4
9	16	7.5	6.8	17.4	21.4
10	16	7.5	7.3	17.4	21.4
12	16	7.5	8.3	17.4	21.4
13	16	7.5	8.8	17.4	21.4
14	16	7.5	9.3	17.4	21.4
15	16	7.5	9.8	17.4	21.4
16	24	11.5	10.3	25.4	29.4
17	24	11.5	10.8	25.4	29.4
18	24	11.5	11.3	25.4	29.4

Unit : mm

No. of Contacts	M	N	Q	R	T
20	24	11.5	12.3	25.4	29.4
21	24	11.5	12.8	25.4	29.4
22	24	11.5	13.3	25.4	29.4
24	24	11.5	14.3	25.4	29.4
26	24	11.5	15.3	25.4	29.4
27	24	11.5	15.8	25.4	29.4
28	24	11.5	16.3	25.4	29.4
30	24	11.5	17.3	25.4	29.4
32	32	14.2	18.3	33.4	37.4
34	32	14.2	19.3	33.4	37.4
40	44	20.2	22.3	45.4	49.4
50	44	20.2	27.3	45.4	49.4

Note : Embossed tape 32mm or wider will have perforated feed holes on two sides.

Recommended Temperature Profile

[For FH19C & FH19SC Series]

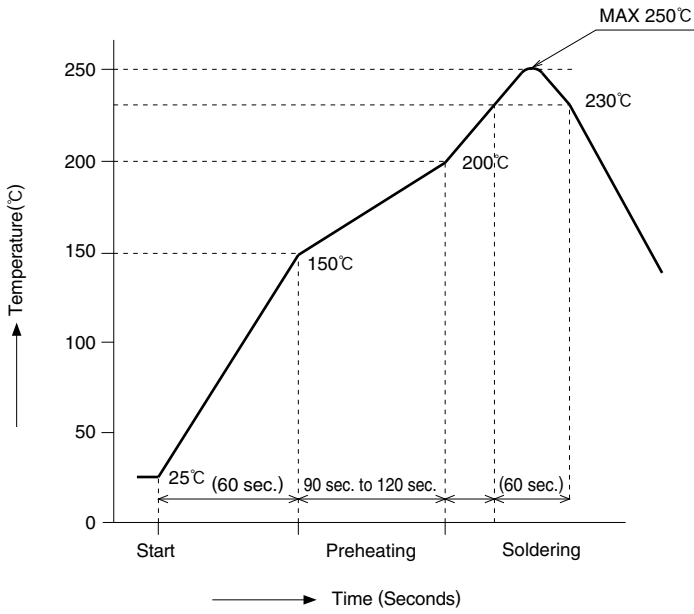

HRS test condition

Solder method	: Reflow, IR/hot air
Solder composition	: Paste, 96.5%Sn/3.0%Ag/0.5%Cu (Senju Metal Industry, Co., Ltd.'s Part Number : M705-221CM5-32- 10.5)
Test board	: Glass epoxy 45mm×100mm×1.6mm thick
Land dimensions	: 0.3mm×0.8mm
Metal mask	: 0.25mm×0.8mm×0.1mm

This temperature profile is based on the above conditions.

In individual applications the actual temperature may vary, depending on solder paste type, volume/thickness and board size/thickness. Consult your solder paste and equipment manufacturer for specific recommendations.

■ Connector Operation and Precautions

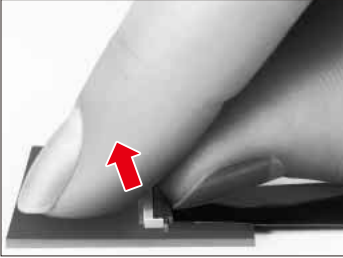
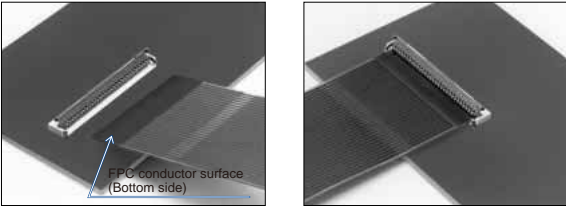
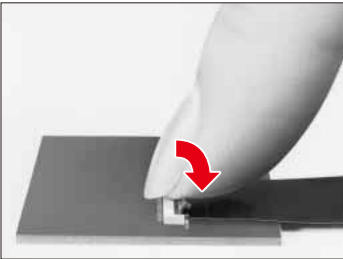
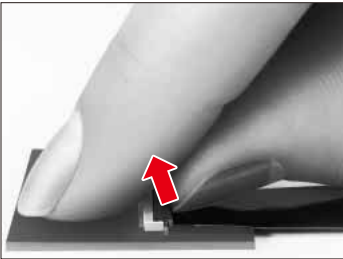
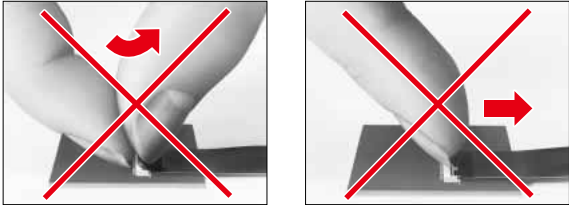
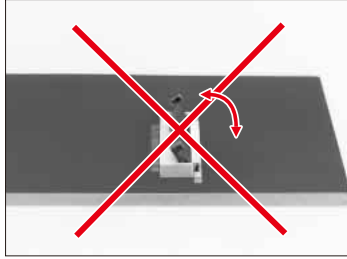
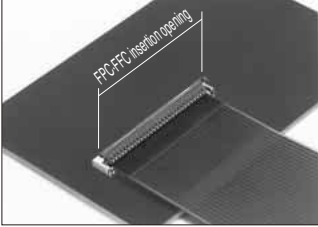
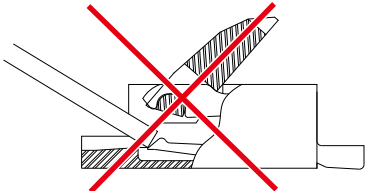
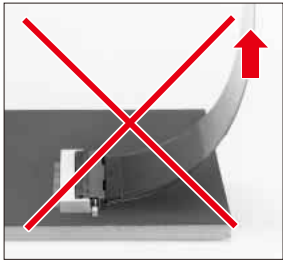
Operation	Precautions
<p>1. FPC/FFC Termination procedure. Connector installed on the board.</p> <p>1) Lift up the actuator. Use thumb or index finger.</p>  <p>2) Assure that the FPC/FFC is fully inserted parallel to mounting surface, with the exposed conductive traces facing down.</p>  <p>3) Rotate down the actuator until firmly closed. It is critical that the inserted FPC/FFC is not moved and remains fully inserted. Should the FPC/FFC be moved, open the actuator and repeat the process, starting with Step 1 above.</p>  <p>2. FPC/FFC Removal</p> <p>1) Lift up the actuator.</p> <p>2) Carefully remove the FPC/FFC.</p> 	<p>1) Do not apply excessive force or use any type of tool to operate the actuator.</p>  <p>2) The connector will assure reliable performance when the actuator is open to 130° maximum. Do not exceed this angle, as this may cause permanent damage to the connector.</p>  <p>3) Insert the FPC/FFC straight into the insertion opening. Failing to follow this precaution can lead to damaging the FPC/FFC and altering its connectivity.</p>  <p>4) When you insert the FPC into the insertion opening, do not apply excessive pressure or scrape the FPC on the bottom of the opening. Doing so can lead to deformities of the contacts and can hinder the performance of the connector.</p>  <p>5) Application of excessive force to the inserted FPC/FFC may cause damage to connector and may affect the reliability of electrical connection. If specific application requires continuous or repeated pull or bend of the inserted FPC/FFC, assure that the forces are NOT transmitted directly to the connector.</p> 

MEMO :

A series of horizontal dashed lines for writing a memo.

USA:
HIROSE ELECTRIC (U.S.A.), INC. HEADQUARTERS CHICAGO OFFICE
 2300 Warrenville Road, Suite 150,
 Downers Grove, IL 60515
 Phone : +1-630-282-6700
<http://www.hirose.com/us/>

USA:
HIROSE ELECTRIC (U.S.A.), INC. SAN JOSE OFFICE
 2841 Junction Ave, Suite 200
 San Jose, CA. 95134
 Phone : +1-408-253-9640
 Fax : +1-408-253-9641
<http://www.hirose.com/us/>

USA:
HIROSE ELECTRIC (U.S.A.), INC. DETROIT OFFICE (AUTOMOTIVE)
 17197 N. Laurel Park Drive, Suite 253,
 Livonia, MI 48152
 Phone : +1-734-542-9963
 Fax : +1-734-542-9964
<http://www.hirose.com/us/>

USA:
HIROSE ELECTRIC (U.S.A.), INC. BOSTON OFFICE
 300 Brickstone Square Suite 201,
 Andover, MA 01810
 Phone : +1-978-662-5255

THE NETHERLANDS:
HIROSE ELECTRIC EUROPE B.V.
 Hogehillweg #8 1101 CC Amsterdam Z-0
 Phone : +31-20-6557460
 Fax : +31-20-6557469
<http://www.hirose.com/eu/>

GERMANY:
HIROSE ELECTRIC EUROPE B.V. GERMAN BRANCH
 Schoenbergstr. 20, 73760 ostfildern
 Phone : +49-711-456002-1
 Fax : +49-711-456002-299
<http://www.hirose.com/eu/>

GERMANY:
HIROSE ELECTRIC EUROPE B.V. NUREMBERG OFFICE
 Neumeyerstrasse 22-26, 90411 Nurnberg
 Phone : +49-911 32 68 89 63
 Fax : +49-911 32 68 89 69
<http://www.hirose.com/eu/>

GERMANY:
HIROSE ELECTRIC EUROPE B.V. HANOVER OFFICE
 Bayernstr. 3, Haus C 30855 Langenhagen, Germany
 Phone : +49-511 97 82 61 30
 Fax : +49-511 97 82 61 35
<http://www.hirose.com/eu/>

FRANCE:
HIROSE ELECTRIC EUROPE B.V. PARIS OFFICE
 130 Avenue Joseph Kessel, Bat E, 78960
 Voisins le Bretonneux, France
 Phone : +33-1-85764886
 Fax : +33-1-85764823
<http://www.hirose.com/eu/>

UNITED KINGDOM:
HIROSE ELECTRIC EUROPE BV (UK BRANCH)
 4 Newton Court, Kelvin Drive, Knowlhill,
 Milton Keynes, MK5 8NH
 Phone : +44-1908 202050
 Fax : +44-1908 202058
<http://www.hirose.com/eu/>

CHINA:
HIROSE ELECTRIC (CHINA) CO., LTD. (SHANGHAI, HEADQUARTERS)
 18, Enterprise Center Tower 2, 209# Gong He
 Road, Jing'an District, Shanghai, CHINA 200070
 Phone : +86-21-6391-3355
 Fax : +86-21-6391-3335
<http://www.hirose.com/cn/>

CHINA:
HIROSE ELECTRIC (CHINA) CO., LTD. BEIJING BRANCH
 A1001, Ocean International Center, Building 56# East 4th
 Ring Middle Road, ChaoYang District, Beijing, 100025
 Phone : +86-10-5165-9332
 Fax : +86-10-5908-1381
<http://www.hirose.com/cn/>

CHINA:
HIROSE ELECTRIC (CHINA) CO., LTD. SHENZHEN BRANCH
 Room 09-13, 19/F, Office Tower Shun Hing Square, Di Wang Commercial Centre,
 5002 Shen Nan Dong Road, Shenzhen City, Guangdong Province, 518008
 Phone : +86-755-8207-0851
 Fax : +86-755-8207-0873
<http://www.hirose.com/cn/>

HONG KONG:
HIROSE ELECTRIC HONGKONG TRADING CO., LTD.
 Room 1001, West Wing, Tsim Sha Tsui Centre, 66
 Mody Road, Tsim Sha Tsui East, Kowloon, Hong Kong
 Phone : +852-2803-5338
 Fax : +852-2591-6560
<http://www.hirose.com/hk/>

TAIWAN:
HIROSE ELECTRIC TAIWAN CO., LTD.
 103 8F, No.87, Zhengzhou Rd., Taipei
 Phone : +886-2-2555-7377
 Fax : +886-2-2555-7355
<http://www.hirose.com/tw/>

KOREA:
HIROSE KOREA CO., LTD.
 143, Gongdan 1-daero, Siheung-si,
 Gyeonggi-do, 15084, Korea
 Phone : +82-31-496-7000
 Fax : +82-31-496-7100
<http://www.hirose.co.kr/>

SINGAPORE:
HIROSE ELECTRIC SINGAPORE PTE. LTD.
 03, Anson Road, #20-01, Springleaf Tower,
 Singapore 079909
 Phone : +65-6324-6113
 Fax : +65-6324-6123
<http://www.hirose.com/sg/>

INDIA:
HIROSE ELECTRIC SINGAPORE PTE. LTD. DELHI LIAISON OFFICE
 Office NO.552, Regus-Green Boulevard, Level5, Tower C,
 Sec62, Plot B-9A, Block B, Noida, 201301, Uttar Pradesh, India
 Phone : +91-12-660-8018
 Fax : +91-120-4804949
<http://www.hirose.com/sg/>

INDIA:
HIROSE ELECTRIC SINGAPORE PTE. LTD. BANGALORE LIAISON OFFICE
 Unit No-403, 4th Floor, No-84, Barton Centre, Mahatma
 Gandhi (MG) Road, Bangalore 560 001, Karnataka, India
 Phone : +91-80-4120 1907
 Fax : +91-80-4120 9908
<http://www.hirose.com/sg/>

MALAYSIA:
PENANG REPRESENTATIVE OFFICE
 73-3-1, Ideal@The One, Jalan Mahsuri, Bayan
 Lepas Penang, 11950, Malaysia
 Phone : +604-648-5536
<http://www.hirose.com/sg/>

THAILAND:
BANGKOK OFFICE (REPRESENTATIVE OFFICE)
 Unit 4703, 47th FL., 1 Empire Tower, South Sathorn
 Road, Yannawa, Sathorn, Bangkok 10120 Thailand
 Phone : +66-2-686-1255
 Fax : +66-2-686-3433
<http://www.hirose.com/sg/>



HIROSE ELECTRIC CO.,LTD.

2-6-3,Nakagawa Chuoh,Tsuzuki-Ku,Yokohama-Shi 224-8540,JAPAN
 TEL: +81-45-620-3526 Fax: +81-45-591-3726
<http://www.hirose.com>
<http://www.hirose-connectors.com>