



# PRODUCT APPROVAL SHEET

Product Type	XTH-SMD2012 Tuning Fork Crystal Units
CREC's P/N	01.X.TH.11CJRVF0000032768
Description	Tuning Fork XTH-SMD2012 32.768KHz 12.5pF ±20ppm 80Kohm
Customer Number	LBY001
Customer P/N	-
Customer Name	-
Revision	B0
Spec No.	LBY001XTH003

Drafting	ISS	CHK.(R&D)	APP.
Sign	杨静		
Date	2023/10/19	2023/10/19	2023/10/19

Process	Site	Tel	Fax	Address
Fab	Chengdu,Sichuan,China	+86-28-60238518 +86-755-83475957	+86-28-60238525 +86-755-83475977	No.8 Baiye Road,West Area of Hi-Tech Zone, Chengdu,sichuan,China
Assembly				
Test				
Web Site	www.chinacrec.com			





# PRODUCT SPECIFICATION

XTH-SMD2012 Tuning Fork Crystal Units



## 【 CONTENTS 】

1	Part explanation	3
2	SCOPE	3
3	Reference Standard	3
4	Title Guide	3
5	Performance	4
6	Figure	4
6.1	Product Dimensions and Solder Pad Layout Dimensions	4
6.2	Marking	5
7	IR Reflow Profile	5
8	Packing specification	6
8.1	Tape Dimensions	6
8.2	Reel and Inner Box Dimensions and Q'ty	6
8.3	Carton Dimensions and Q'ty	6
9	Reliability Test Item	7
10	Product handling and control procedure	8
10.1	Precautions for storage	8
10.2	Mounting of SMD Type products	8
10.3	Ultrasonic cleaning	8
10.4	Ultrasonic welding	8

Rev	CREC's P/N	Cust P/N	Page
B0	01.X.TH.11CJR VF0000032768	-	2



# PRODUCT SPECIFICATION

XTH-SMD2012 Tuning Fork Crystal Units



## 1 Parts explanation

The 32.768kHz tuning fork crystal unit is the most widely used frequency control product. Its low power consumption is ideal for portable applications. The different package sizes provide customers more choices for time management.

## 2 SCOPE

This specification only covers CREC's 01.X.TH.11CJR VF0000032768

## 3 Reference Standard

- 3.1 MIL-STD-883H :Environmental tests' Mechanical tests.
- 3.2 MIL-STD-202 : Test Methods for Electronic and Electrical component part.
- 3.3 IEC 60068-2 :Environmental tests' Mechanical tests.
- 3.4 ANSI/EIA-481-C : 8mm through 200mm embossed carrier taping and 24mm punched
- 3.5 JEDEC J-STD-020C: Soldering

## 4 Title Guide

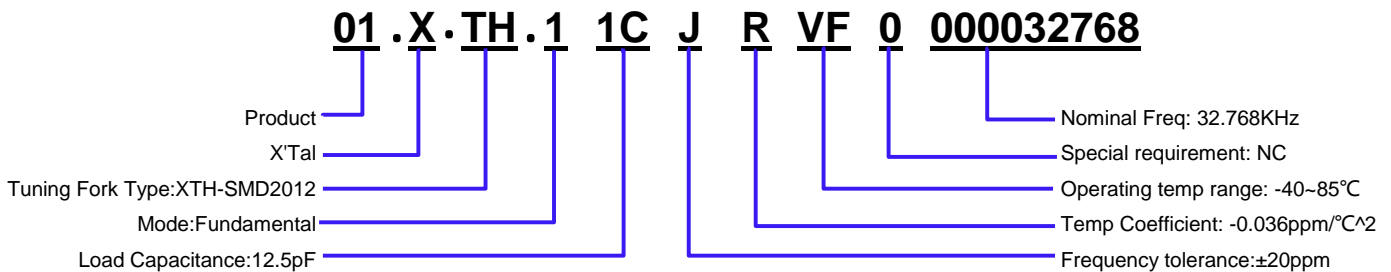

Rev	CREC's P/N	Cust P/N	Page
B0	01.X.TH.11CJR VF0000032768	-	3

### 5 Performance

Electrical Performance. Electrical characteristics measured by S&A250B.

No.	Item	Symb.	Electrical Specification				Remark (Humidity: 40%~60%)
			Min.	Type	Max.	Unit	
1	Nominal Frequency	F0	32.768000			KHz	-
2	Mode of vibration	-	Fundamental			-	-
3	Frequency tolerance	$\Delta F/F0$	-20	-	20	ppm	25°C±3°C
4	Operating Temperature Range	T <sub>OPR</sub>	-40	-	85	°C	-
5	Storage Temperature	T <sub>stg</sub>	-55	-	125	°C	-
6	Temperature Coefficient	$\beta$	-	-0.036	-	ppm/°C <sup>2</sup>	-
7	Load Capacitance	CL	-	12.5	-	pF	-
8	Equivalent Series Resistance	ESR	-	-	80	Kohm	25°C±3°C
9	Drive Level	DL	-	0.1	0.5	μW	25°C±3°C
10	Insulation Resistance	IR	500	-	-	Mohm	@DC100V
11	Aging	Year	-3	-	3	ppm	First Year
12	Quality Factor	Q	13	-	-	K	25°C±3°C
13	Shunt Capacitance	C0	-	1.15	3	pF	25°C±3°C
14	Motional Capacitance	C1	-	4.65	-	fF	25°C±3°C

### 6 Figure

6.1 Product Dimensions and Solder Pad Layout Dimensions (Unit:mm)

Product Dimensions

Solder Pad Layout Dimensions

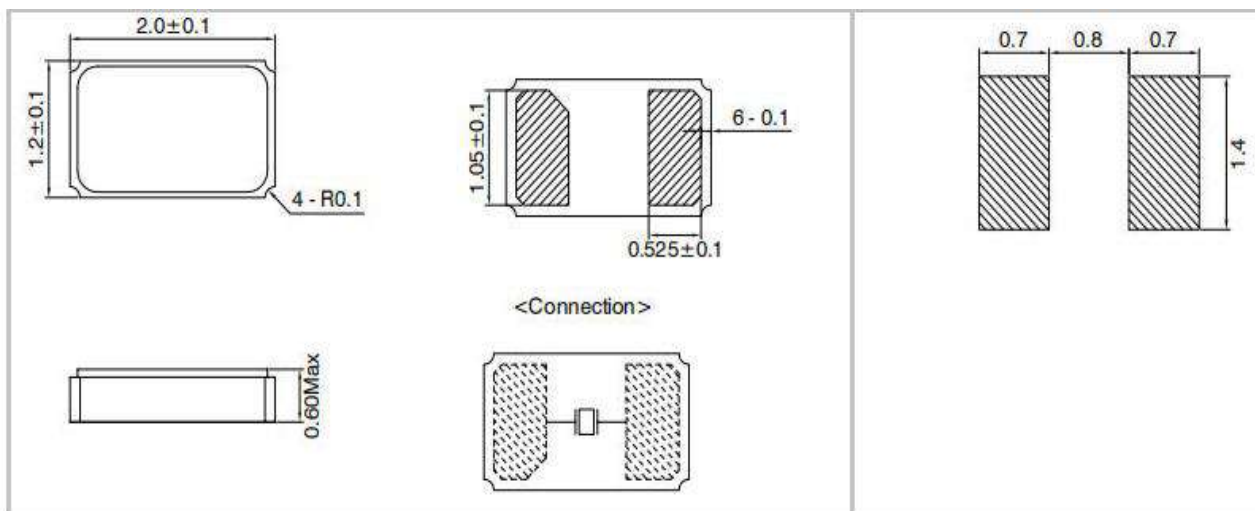

Rev	CREC's P/N	Cust P/N	Page
B0	01.X.TH.11CJRVF0000032768	-	4

### 6.2 Marking



### 7 IR Reflow Profile

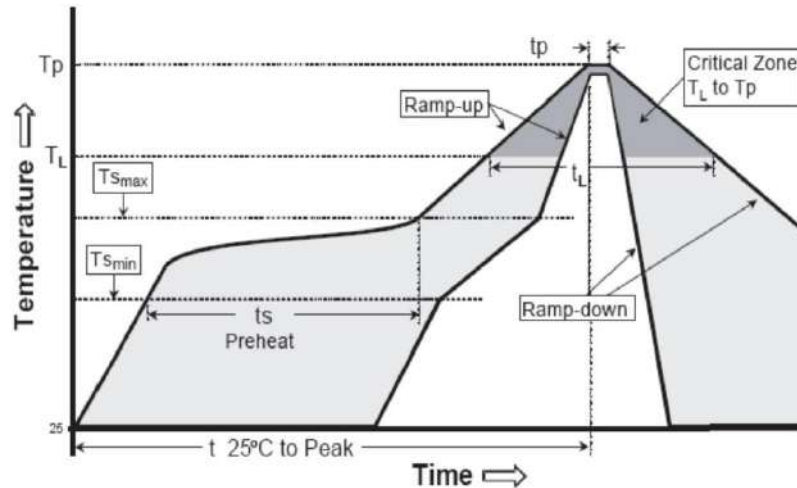

Remark: Reference JEDEC J-STD-020C

Profiles Feature	Pb-Free Assembly
Average Ramp-up Rate (Ts max to Tp)	3°C/second max.
Preheat	
■ Temperature Min (Ts min)	125°C
■ Temperature Max (Ts max)	200°C
■ Time (ts min to ts max)	60~180 seconds
Time maintained above	
■ Temperature (T <sub>L</sub> )	217°C
■ Time (t <sub>L</sub> )	60~150 seconds
Peak/Classification Temperature (T <sub>p</sub> )	260°C
Time within 5°C of actual Peak	20~40 seconds
Temperature (t <sub>p</sub> )	
Ramp-down rate	6°C/second Max
Time 25°C to Peak Temperature	8 minutes Max
Suggest reflow times	3 times

Rev	CREC's P/N	Cust P/N	Page
B0	01.X.TH.11CJRVF0000032768	-	5

### 8 Packing specification

#### 8.1 Tape Dimensions

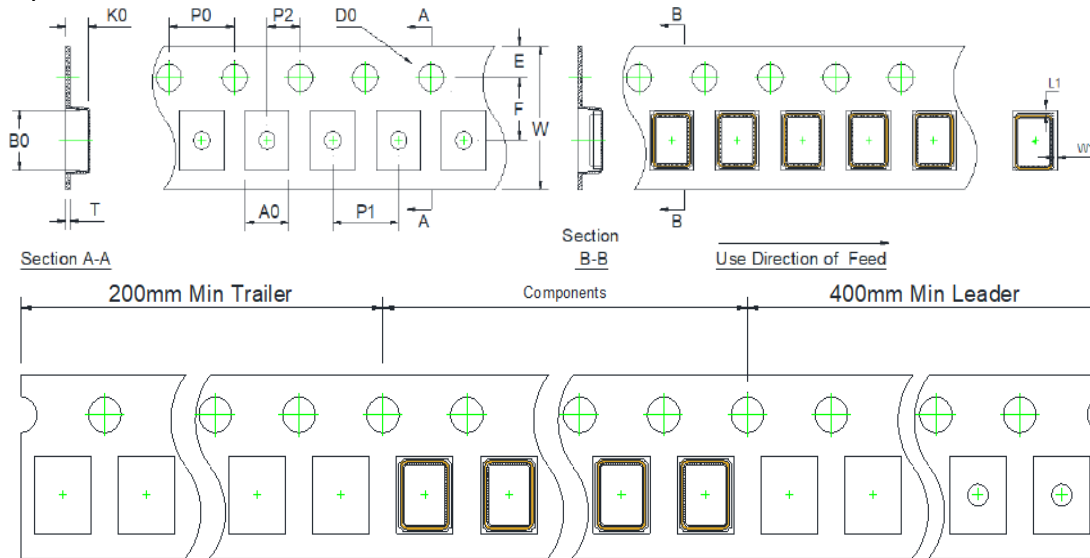

ITEM	W	P1	E	F	D0	P0	P2	A0	B0	K0	T	L1	W1
Spec(mm)	8.00	4.00	1.75	3.50	1.55	4.00	2.00	1.40	2.30	0.75	0.25	0.20	0.20
Tol.(mm)	±0.30	±0.10	±0.22	±0.10	±0.05	±0.10	±0.10	±0.10	±0.10	±0.10	±0.05	±0.05	±0.05

#### 8.2 Reel and Inner Box Dimensions and Q'ty

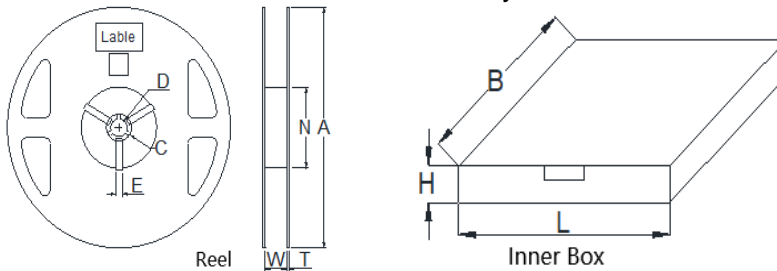

Item	Reel							Inner Box		
	A	W	N	C	D	E	T	L	B	H
SPEC(mm)	178	9.3	60.0	20.0	13.0	2.3	1.4	180	180	30
Tol.(mm)	±2.0	±0.5	±0.5	±1.0	±0.5	±0.5	±0.2	-	-	-
Q'ty (pcs)	3K/Reel Max							6K/Box Max		

#### 8.3 Carton Dimensions and Q'ty

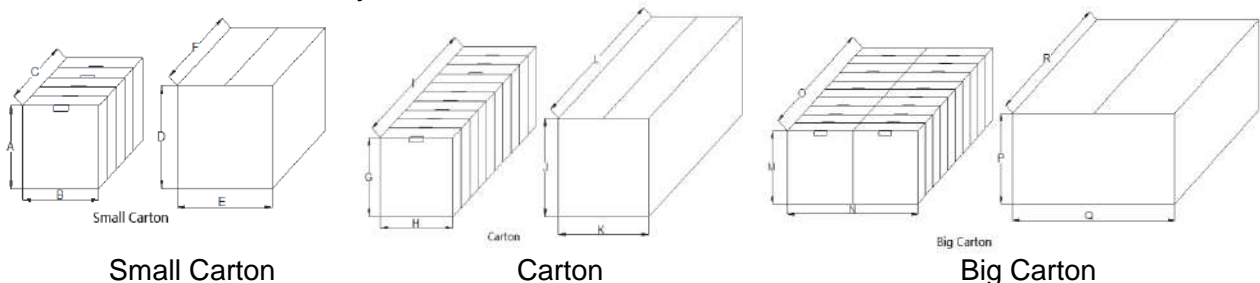

Item	Small Carton						Carton						Big Carton					
	A	B	C	D	E	F	G	H	I	J	K	L	M	N	O	P	Q	R
SPEC(mm)	180	180	150	230	230	230	180	180	300	230	230	350	180	360	300	230	350	410
Q'ty (pcs)	30K/Carton Max						60K/Carton Max						120K/Carton Max					

Rev	CREC's P/N	Cust P/N	Page
B0	01.X.TH.11CJR VF0000032768	-	6

### 9 Reliability Test Item

No.	Item	Test Condition	Reference
1	Drop Test	Hight: 50cm Times: 2 times on hardWood	IEC68-2-32 Free Fall
2	Vibration	Frequency: 20 to2000Hz, full wave Amplitude: 1.5 mm (Peak to Peak) Sweep/Cycle: 2 minutes Accelerated Speed: 20g Direction: X, Y,Z Duration: 4min ,4 times in each direction	IEC68-2-6 Vibration
3	Solderability	Temperature: 235±5℃ Time: 10±1 Sec	MIL-STD-202 Method 210B Condition B
4	Aging	Temperature: 100℃ Time:168 hours	MIL-STD-883H Method 1008.2
5	Fine Leak	Helium Bombing:0.4~0.5Mpa Time:1 hour	MIL-STD-883H METHOD 1014.13
6	High Temperature Storage	Temperature: 85℃ ± 5℃ Time 96 hours	IEC 60068-2-2
7	Temperature Cycle	Conditions: 25℃ ± 3℃ for 10 minutes -40℃ ± 3℃for 30 minutes 25℃ ± 3℃ for 10 minutes 125℃± 3℃ for 30 minutes 100 cycles	MIL-STD-883H METHOD 1010.8
8	Resistance to Soldering Heat	Pre-Heating:125℃ 60~120 Sec Solder temperature: 260± 5℃ Time: 20±5 sec	MIL-STD-202 Method 210B Condition B
9	Humidity	Temperature: 60℃ ± 2℃ Relative Humidity: 95% Time: 96 hours.	IEC 60068-2-3 Damp Heat
10	Thermal shock	-40℃ ± 3℃ to 100℃ ± 3℃, soak 15 minutes at each point, transfer time within 15 seconds, 20 cycles.	MIL-STD-883H METHOD 1011.9
11	Low Temperature Storage	Temperature: -40℃ ± 5℃ Time: 96 hours	IEC 60068-2-1
12	IR Reflow	Pre-Heating:150℃ to 200℃, 60-120 Sec Heating:217℃, 60 to 150 Sec Peak temp:260℃±5℃,20±5 Sec Times: 2 times	JEDEC J-STD-020C
13	Salt Spray	Temperature: 35±2℃ Salinity: 5% Time:24hrs	MIL-STD-883H Method 1009.8 Condition A

Rev	CREC's P/N	Cust P/N	Page
B0	01.X.TH.11CJRVF0000032768	-	7



### 10 Product handling and control procedure

#### 10.1 Precautions for storage

Storage of crystal units under higher temperature or high humidity for a long term may affects frequency stability or solderability. Please store the crystal units under the normal temperature and humidity without exposing to direct sunlight and dew condensation, and avoid the storage of crystal units for more than 6 months, and mount them as soon as possible after unpacking.

Item		Electrical Specification			
		Min.	Type	Max.	Unit
Storage peiod	After customer assembly	15		-	Year
	Crystal unused	-		2	Year

#### 10.2 Mounting of SMD Type products

When using an automatic loading machine, please test and confirm to cause no damage to the crystal units before mounting. Bending the circuit board in the process of cleaving boards after mounting and soldering crystal units may cause peeling off the soldering or package cracks by mechanical stress.

#### 10.3 Ultrasonic cleaning

General cleaning solutions or ultrasonic cleaning method may be used to clean CREC's products. However, under certain circumstances, ultrasonic cleaning machine could generate resonance at the oscillaton frequency of our products and thus deteriorate the electrical characteristics in devices, and even damage the overall structure of devices. Therefore, verification test is recommended before cleaning.

#### 10.4 Ultrasonic welding

Avoid mounting and processing by Ultrasonic welding this method has a possibility of an excessive vibration spreading inside the crystal products and becoming the cause of characteristic deterioration and not oscillating. If Ultrasonic welding is being used in process, please notify us in advance to verify it.

Rev	CREC's P/N	Cust P/N	Page
B0	01.X.TH.11CJRVF0000032768	-	8