

Data sheet

Order No.: 1714886

Type: FP 1,27/ 50-FV 9,05

SMD female connector, Reflow soldering

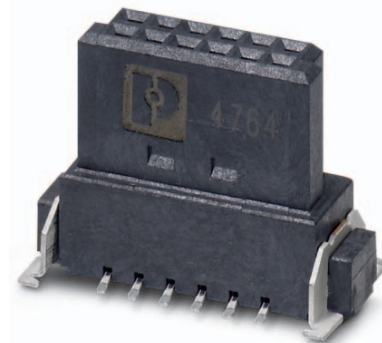

The figure shows a 12-pos. version with 12 contacts

1 Main features



• No. of pos.	50	• Nominal current	1.4 A
• Test voltage	500 V AC	• Mounting type	SMD soldering
• Color	black (9005)	• Connection direction	90 °
• Pitch	1.27 mm	• Type of packaging	56 mm wide tape

2 Your advantages

- ✓ Gold-plated contacts ensure transfer quality remains stable over the long term
- ✓ Compact, high-position board-to-board or wire-to-board connectors for space-saving device designs
- ✓ Stacked, coplanar or orthogonal PCB connections enable maximum flexibility in the device
- ✓ Male and female connectors of different height can be combined – for individual PCB spacing of 8 mm ... 13.8 mm



Make sure you always use the latest documentation.

It can be downloaded at: phoenixcontact.net/product/1714886

3 Table of contents

1	Main features.....	1
2	Your advantages	1
3	Table of contents	2
4	3D model in PDF can be activated (Acrobat Reader only).....	3
5	General Technical Data	4
	5.1 item properties	4
	5.2 Material data	4
6	Dimensions.....	5
	6.1 Dimensions for the product	5
	6.2 Dimensions for the application	5
7	Series drawing.....	6
8	Packaging information	7
9	Blister drawing.....	8
10	Application.....	9
	10.1 Temperature limit values	9
11	General tests	10
	11.1 Specification.....	10
12	Mechanical tests.....	11
	12.1 Insertion and withdrawal force per contact	11
	12.2 Service life	11
13	Electrical tests	12
	13.1 Electrical data	12
	13.2 Air and creepage distances	12
14	Current carrying capacity/derating curves	13
	14.1 Insulation resistance.....	13
	14.2 forward resistance	13
	14.3 Vibration test	13
15	Approvals	14
16	Commercial Data.....	15
17	Combination tests.....	16

1714886 FP 1,27/ 50-FV 9,05

4 3D model in PDF can be activated (Acrobat Reader only)

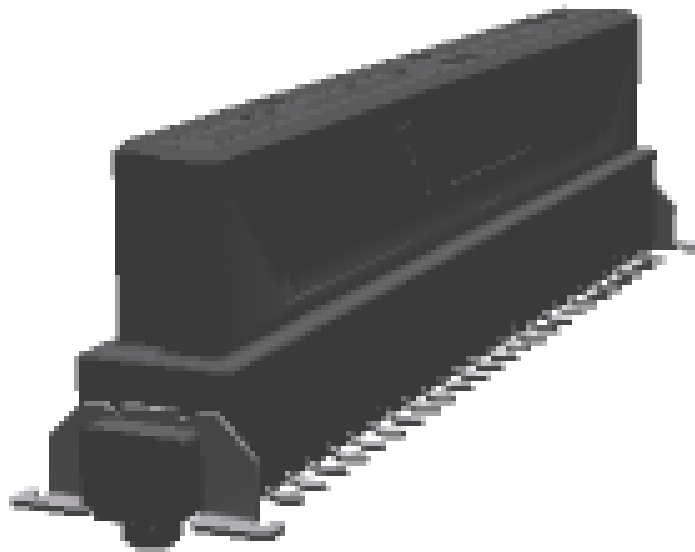

1714886 FP 1,27/ 50-FV 9,05**5 General Technical Data****5.1 item properties**

Order No.	1714886
Type	FP 1,27/ 50-FV 9,05
Plug-in system	Fine Pitch 1,27 mm
Product type	SMD female connector
Type of contact	Female connector
Range of articles	FP 1,27/...-FV 9,05
Pitch	1.27 mm
Range of positions	12...80
Number of positions	50
Number of levels	2
Number of potentials	50
Mounting type	SMD soldering
Connection direction of the connector to the PCB	90 °
Pin layout	Linear pad geometry

5.2 Material data

Material of metal parts	
Note	WEEE/RoHS-compliant, whisker-free acc. to IEC 60068-2-82/JEDEC JESD 201
Contact material	Cu alloy
Surface contact area	Nickel (Ni), Palladium nickel (PdNi) , Gold (Au)
Surface characteristics	Selective coating
Insulating material data	
Insulating material	LCP
Insulating material group	IIIa
CTI according to IEC 60112	175
Flammability rating according to UL 94	V0
Color	black (9005)

1714886 FP 1,27/ 50-FV 9,05**6 Dimensions****6.1 Dimensions for the product**

Length	7.2 mm
Width	36.84 mm
Total height	9.75 mm
Height	9.05 mm
Base height	9.05 mm
Positioning pin geometry	ø 1.5-0.05 mm, Length of positioning pin: 0.75 mm ø 1.5-0.05 mm, Length of positioning pin: 0.75 mm
Positioning pin geometry	ø 1.5-0.05 mm, Length of positioning pin: 0.75 mm ø 1.5-0.05 mm, Length of positioning pin: 0.75 mm
Coplanarity	≤ 0.1 mm

6.2 Dimensions for the application

Contact cover	0.9 mm
Overlap length	1.5 mm
Medium offset	± 0.7 mm in longitudinal and transverse direction
Angular tolerance	± 4 ° in longitudinal direction
Angular tolerance	± 2 ° in transverse direction
Stacking height	10.8 mm Tolerance: +1,5 mm (in combination with Range of articles:FP 1,27/...-MV 1,75)
Stacking height	12.3 mm Tolerance: +1,5 mm (in combination with Range of articles:FP 1,27/...-MV 3,25)

1714886 FP 1,27/ 50-FV 9,05

7 Series drawing

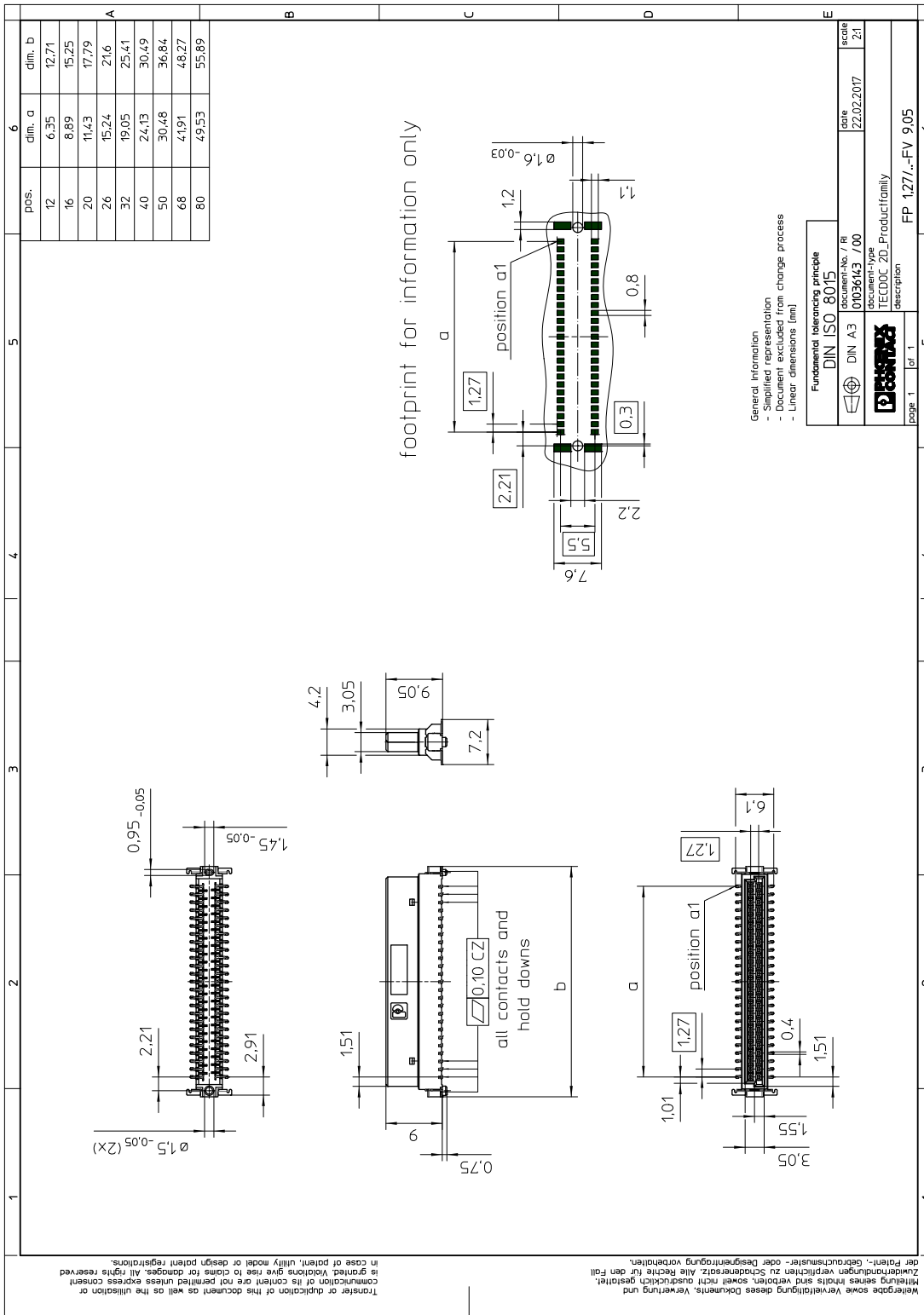

1714886 FP 1,27/ 50-FV 9,05**8 Packaging information**

Type of packaging	56 mm wide tape
Note on packaging	Tape-on-reel packaging in accordance with standard DIN EN 60286-3 and EIA-481
Pieces per package	280
Outer packaging type	Transparent-Bag
[W] tape width	56 mm
[A] coil diameter	330 mm
[W2] coil overall dimension	62.4 mm
Number of products per coil	280

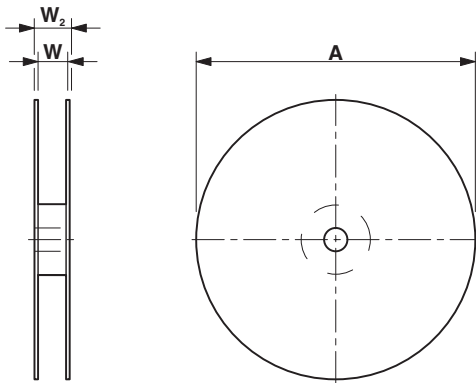

1714886 FP 1,27/ 50-FV 9,05

9 Blister drawing

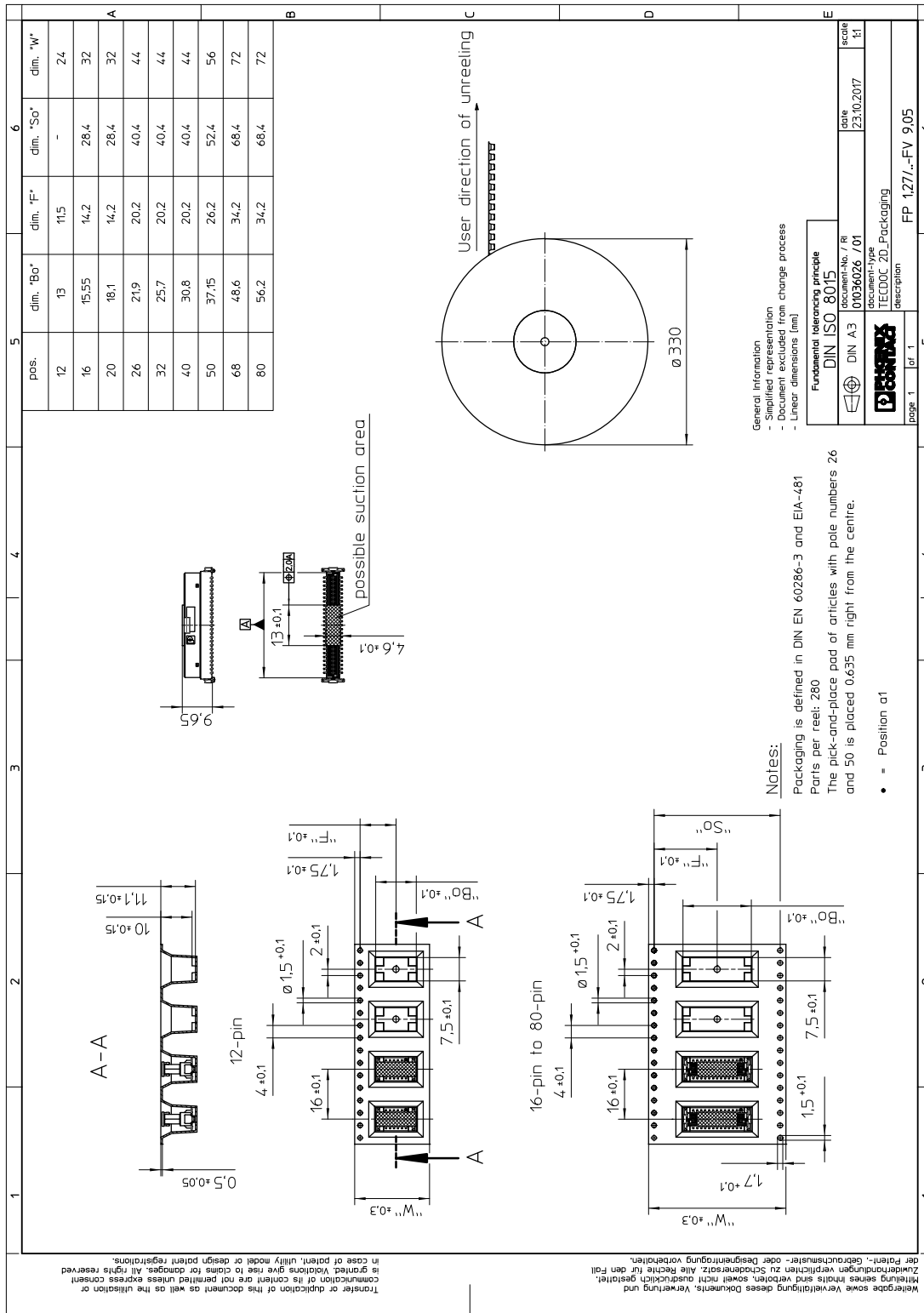

10 Application

10.1 Temperature limit values

Ambient temperature (storage/transport)	-40 °C ... 70 °C
Ambient temperature (assembly)	-5 °C ... 100 °C
Ambient temperature (operation)	-55 °C ... 125 °C

11 General tests

11.1 Specification

Brief description

Board-to-board connectors

1714886 FP 1,27/ 50-FV 9,05

12 Mechanical tests

12.1 Insertion and withdrawal force per contact

Insertion and withdrawal force per contact	approx. 0.5 N
--	---------------

12.2 Service life

Specification	IEC 60512-9-1:2010-03 (following)
Service life	500 Insertion/withdrawal cycles, Performance level 1

1714886 FP 1,27/ 50-FV 9,05**13 Electrical tests****13.1 Electrical data**

Nominal current at 20 °C	1.4 A IEC 60512-5-2:2002-02 (50-pos.)
Test voltage	500 V AC IEC 60512-4-1:2003

13.2 Air and creepage distances

Minimum value for clearance and creepage distance	0.4 mm
---	--------

1714886 FP 1,27/ 50-FV 9,05**14 Current carrying capacity/derating curves**

Specification	IEC 60512-5-2:2002-02
Note	Representation based on IEC 60512-5-2:2002-02
Reduction factor	0.8
Number of positions	See diagram

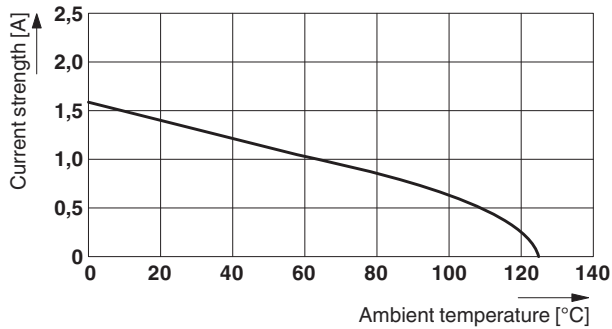
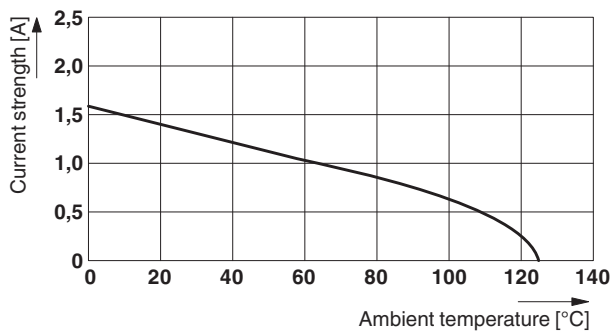
Type: FP 1,27/...-FV 9,05 with FP 1,27/...-MV 1,75**Type: FP 1,27/...-FV 9,05 with FP 1,27/...-MV 3,25****14.1 Insulation resistance**

Insulation resistance	≥ 10 GΩ, (IEC 60512-3-1:2002-02)
-----------------------	----------------------------------

14.2 forward resistance

Contact resistance	≤25 mΩ, (IEC 60512-2-1:2002-02)
--------------------	---------------------------------

14.3 Vibration test

Specification	IEC 60068-2-6:2007-12
Result	Test passed
Frequency	10 - 2000 - 10 Hz
Sweep speed	1 octave/min
Amplitude	1.5 mm (10 - 60.1 Hz)
Acceleration	20g (60.1 - 2000 Hz)

1714886 FP 1,27/ 50-FV 9,05

Test duration per axis

2.5 h

Test directions

X-, Y- and Z-axis

Note

15 Approvals

cULus Recognized  US



1714886 FP 1,27/ 50-FV 9,05**16 Commercial Data**

Order No.	1714886
Type	FP 1,27/ 50-FV 9,05
Pieces per package	280
Net weight	3.796 g
GTIN	4055626400488
	Information that applies locally, see link on page 1
Country of origin	Information that applies locally, see link on page 1

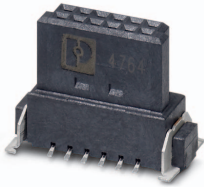
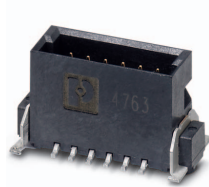
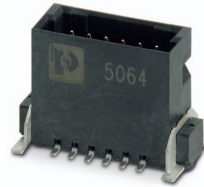
1714886 FP 1,27/ 50-FV 9,05**17 Combination tests****FP 1,27/...-FV 9,05****FP 1,27/...-MV
1,75****FP 1,27/...-MV
3,25**

Mechanical tests				
Insertion/withdrawal force per position	approx. 0.5 N / 0.5 N	approx. 0.5 N / 0.5 N		
Durability tests				
Contact resistance R ₁	25 mΩ	25 mΩ		
Insertion/withdrawal cycles	500	500		
Contact resistance R ₂	25 mΩ	25 mΩ		
Test voltage	500 V AC	500 V AC		
Thermal tests				
Tested number of positions	50	50		
Test current	1.4 A	1.4 A		