

Receptacle Connectors (Wire Applied)

Standard Type Receptacle Contacts

Material:

Pre-Tin Brass, Pre-Tin Phos. Brz or Gold over Nickel plated Phosphor Bronze

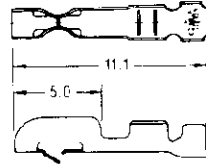

Wire Size AWG (mm ²)	Wire Ins. Dia.	Contact Part Number						Hand Tool Part No.
		Brass/Pre-Tin		Phos. Brz./Pre-Tin		Phos. Brz./ Gold over Nickel*		
		S.T.	L.P.	S.T.	L.P.	S.T.	L.P.	
30-26 (0.06-0.15)	1.0-1.4	170263-1	170205-1	170263-2	170205-2	170263-3	170205-3	722561-1
26-20 (0.14-0.52)	1.1-1.9	170262-1	170204-1	170262-2	170204-2	170262-4	170204-4	722560-1

*Phosphor Bronze, 0.36µm Gold on contact area with Nickel under-plated.
Hand Tool Instruction Sheet 1S-071J

Standard Type Receptacle Housings For Standard Circuit (2.5mm)

Material:

UL 94V-0 rated, 6/6 ny on
See chart for color.

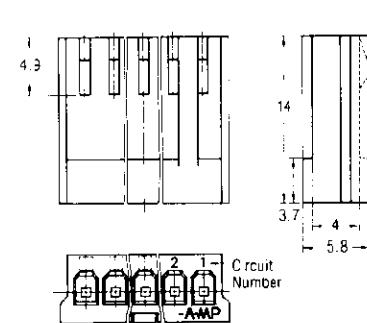
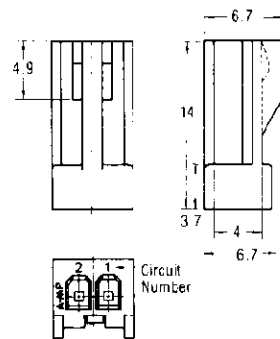
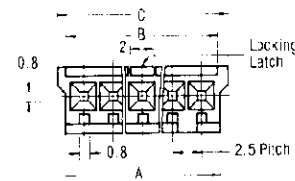
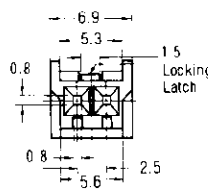
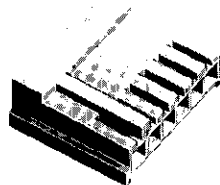

2 Position Housing

3 ~ 12 Position Housing

No. of Pos.	Dimensions			Part No. of Receptacle Housing				
	A	B	C	Natural*	Black	Blue	Green	Red
2	—	—	—	171822-2	2-171822-2	4-171822-2	6-171822-2	8-171822-2
3	8.1	7.8	9.4	171822-3	2-171822-3	4-171822-3	6-171822-3	8-171822-3
4	10.6	10.3	11.9	171822-4	2-171822-4	4-171822-4	6-171822-4	8-171822-4
5	13.1	12.8	14.4	171822-5	2-171822-5	4-171822-5	6-171822-5	8-171822-5
6	15.6	15.3	16.9	171822-6	2-171822-6	4-171822-6	6-171822-6	8-171822-6
7	18.1	17.8	19.4	171822-7	2-171822-7	4-171822-7	6-171822-7	8-171822-7
8	20.6	20.3	21.9	171822-8	2-171822-8	4-171822-8	6-171822-8	8-171822-8
9	23.1	22.8	24.4	171822-9	2-171822-9	4-171822-9	6-171822-9	8-171822-9
10	25.6	25.3	26.9	1-171822-0	3-171822-0	5-171822-0	7-171822-0	9-171822-0
11	28.1	27.8	29.4	1-171822-1	3-171822-1	5-171822-1	7-171822-1	9-171822-1
12	30.6	30.3	31.9	1-171822-2	3-171822-2	5-171822-2	7-171822-2	9-171822-2
13	33.1	32.8	34.4	1-171822-3	3-171822-3	5-171822-3	7-171822-3	9-171822-3
14	35.6	35.3	36.9	1-171822-4	3-171822-4	5-171822-4	7-171822-4	9-171822-4
15	38.1	37.8	39.4	1-171822-5	3-171822-5	5-171822-5	7-171822-5	9-171822-5

*Natural is the standard and will be stocked. Other colors, minimums may apply.