

Keysight 34921A-34925A Low Frequency Multiplexer Modules

Notices

Copyright Notice

© Keysight Technologies 2008-2022

No part of this manual may be reproduced in any form or by any means (including electronic storage and retrieval or translation into a foreign language without prior agreement and written consent from Keysight Technologies as governed by United States and international copyright laws.

Trademarks

Microsoft® and Windows® are U.S. registered trademarks of Microsoft Corporation.

Manual Part Number

34980-90021

Edition

Edition 5, Aug 2022

Printed in:

Printed in Malaysia

Published by:

Keysight Technologies
Bayan Lepas Free Industrial Zone,
11900 Penang, Malaysia

Technology Licenses

The hardware and/or software described in this document are furnished under a license and may be used or copied only in accordance with the terms of such license.

Declaration of Conformity

Declarations of Conformity for this product and for other Keysight products may be downloaded from the Web. Go to <http://www.keysight.com/go/conformity>. You can then search by product number to find the latest Declaration of Conformity.

U.S. Government Rights

The Software is “commercial computer software,” as defined by Federal Acquisition Regulation (“FAR”) 2.101. Pursuant to FAR 12.212 and 27.405-3 and Department of Defense FAR Supplement (“DFARS”) 227.7202, the U.S. government acquires commercial computer software under the same terms by which the software is customarily provided to the public. Accordingly, Keysight provides the Software to U.S. government customers under its standard commercial license, which is embodied in its End User License Agreement (EULA), a copy of which can be found at <http://www.keysight.com/find/sweula>. The license set forth in the EULA represents the exclusive authority by which the U.S. government may use, modify, distribute, or disclose the Software. The EULA and the license set forth therein, does not require or permit, among other things, that Keysight: (1) Furnish technical information related to commercial computer software or commercial computer software documentation that is not customarily provided to the public; or (2) Relinquish to, or otherwise provide, the government rights in excess of these rights customarily provided to the public to use, modify, reproduce, release, perform, display, or disclose commercial computer software or commercial computer software documentation. No additional government requirements beyond those set forth in the EULA shall apply, except to the extent that those terms, rights, or licenses are explicitly required from all providers of commercial computer software pursuant to the FAR and the DFARS and are set forth specifically in writing elsewhere in the EULA. Keysight shall be under no obligation to update, revise or otherwise modify the Software. With respect to any technical data as defined by FAR 2.101, pursuant to FAR 12.211 and 27.404.2 and DFARS 227.7102, the U.S. government acquires no greater than Limited Rights as defined in FAR 27.401 or DFAR 227.7103-5 (c), as applicable in any technical data.

Warranty

THE MATERIAL CONTAINED IN THIS DOCUMENT IS PROVIDED “AS IS,” AND IS SUBJECT TO BEING CHANGED, WITHOUT NOTICE, IN FUTURE EDITIONS. FURTHER, TO THE MAXIMUM EXTENT PERMITTED BY APPLICABLE LAW, KEYSIGHT DISCLAIMS ALL WARRANTIES, EITHER EXPRESS OR IMPLIED, WITH REGARD TO THIS MANUAL AND ANY INFORMATION CONTAINED HEREIN, INCLUDING BUT NOT LIMITED TO THE IMPLIED WARRANTIES OF MERCHANTABILITY AND FITNESS FOR A PARTICULAR PURPOSE. KEYSIGHT SHALL NOT BE LIABLE FOR ERRORS OR FOR INCIDENTAL OR CONSEQUENTIAL DAMAGES IN CONNECTION WITH THE FURNISHING, USE, OR PERFORMANCE OF THIS DOCUMENT OR OF ANY INFORMATION CONTAINED HEREIN. SHOULD KEYSIGHT AND THE USER HAVE A SEPARATE WRITTEN AGREEMENT WITH WARRANTY TERMS COVERING THE MATERIAL IN THIS DOCUMENT THAT CONFLICT WITH THESE TERMS, THE WARRANTY TERMS IN THE SEPARATE AGREEMENT SHALL CONTROL.

Safety Information

CAUTION















A CAUTION notice denotes a hazard. It calls attention to an operating procedure, practice, or the like that, if not correctly performed or adhered to, could result in damage to the product or loss of important data. Do not proceed beyond a CAUTION notice until the indicated conditions are fully understood and met.

WARNING

A WARNING notice denotes a hazard. It calls attention to an operating procedure, practice, or the like that, if not correctly performed or adhered to, could result in personal injury or death. Do not proceed beyond a WARNING notice until the indicated conditions are fully understood and met.

Safety Symbols

The following symbols or markings that may be on or with the instrument and in the documentation indicate precautions which must be taken to maintain safe operation of the instrument.

	Alternating current (AC)		Caution, risk of electric shock
	Frame or chassis (ground) terminal		Caution, risk of danger (refer to this manual for specific Warning or Caution information)
	Standby supply. Unit is not completely disconnected from ac mains when switch is off		Direct current (DC)
	Off (mains supply)		On (mains supply)
	Three phase alternating current		Presence of a laser device
	Protective earth (ground) terminal		Equipment protected throughout by double insulation or reinforced insulation
	Caution, hot surface		Product is sensitive to electrostatic discharge

Additional Safety Notices

The following general safety precautions must be observed during all phases of operation of this instrument. Failure to comply with these precautions or with specific warnings or instructions elsewhere in this manual violates safety standards of design, manufacture, and intended use of the instrument. Keysight Technologies assumes no liability of the customer's failure to comply with the requirements.

WARNING

Refer to the 34980A User's Guide before using the equipment. The 34980A User's Guide contains additional important information about the modules.

WARNING

GENERAL

If this product is not used as specified in the operating instructions, the protection provided by the equipment could be impaired. This product must be used in a normal condition (in which all means for protection are intact) only. Any external connections must be made prior to applying power.

CAUTION

This instrument has auto-ranging line voltage input. Be sure the supply voltage is within the specified range and voltage fluctuations do not to exceed 10 percent of the nominal supply voltage.

NOTE

Pollution Degree 1: No pollution or only dry, non-conductive pollution occurs. The pollution has no influence (on insulation).

Pollution Degree 2: Normally only non-conductive pollution occurs. Occasionally, a temporary conductivity (leakage current between isolated conductors) caused by condensation can be expected.

WARNING**GROUND THE INSTRUMENT**

This is a Safety Protection Class I Product (provided with a protective earthing ground incorporated in the power cord). The mains plug shall only be inserted in a socket outlet provided with a protective earth contact. Any interruption of the protective conductor inside or outside of the product is likely to make the product dangerous. Intentional interruption is prohibited. The mains wiring and connectors shall be compatible with the connector used in the premise electrical system. Inadequate earth grounding can damage the instrument. Always use the three-prong AC power cord supplied with the instrument.

Connect the AC power cord as follow:

- Ensure that the power cord is not damaged.
 - Install the signal generator so that one of the following items is readily identifiable and easily reached by the operator: AC power cord, alternative switch or circuit breaker.
 - Insert the mains plug into a socket outlet provided with a protective earth grounding.
-

WARNING**IN CASE OF DAMAGE**

Do not use the instrument if it is damaged. Before you use the instrument inspect all connections. Pay particular attention to the insulation surrounding connectors and / or cable assembly insulation. NEVER use a cable showing any signs of damage. Faulty cables can cause electrical shock and /or fire hazards and could lead to personal injury or death.

WARNING

Safety of any system incorporating the equipment is the responsibility of the assembler of the system.

WARNING

The detachable power cord is the instrument disconnecting device. It disconnects the mains circuits from the mains supply before other parts of the instrument. The front panel switch is only a standby switch and is not a LINE switch (disconnecting device). The instrument power cord does not disconnect or de-energize external circuits connected to the analog bus, terminal blocks or modules.

WARNING

Keysight Customers utilizing the Open Platform Test Systems are classified as follows and require the user to have the appropriate skillset:

Operator: Interacts with the test system in a production environment, selection of test sequences, defining variables, running tests (test results, test statistics, control of marking devices)

Supervisor: Includes access to maintenance functions and utility sequences (control of hardline system functions, access to test area)

Developer: Full access

WARNING

Dangerous voltage levels capable of causing death, may be present on a channel. Use extreme caution when handling and testing and adjusting this instrument. Any voltages greater than 30 Vrms, 42.4 Vpeak and 60 Vdc are considered hazardous (IEC 61010-1).

WARNING

The maximum common mode input to any one system component within the system installation is not to exceed the maximum stated ratings.

WARNING

When interconnecting system components, the overall system maximum allowable input rating of the system would default to the lowest rating of any one system component.

WARNING

Removal of the instrument's cover is to be conducted by qualified personnel only. Only qualified, trained personnel who are aware of the hazards involved should remove instrument covers. Prevent operators from accessing any external circuits, test fixtures, cables or wherever hazardous voltages may be present. Failure to recognize and observe normal safety precautions could result in personal injury or death.

WARNING

Under certain conditions, dangerous voltage levels capable of causing injury or death may remain even after external circuits have been disconnected. To avoid electrical shock, remove the main power cord from the 34980A and ensure all connections to the DUT, including field wiring to the instrument and the analog bus (if present) are deenergized and all circuits are discharged before coming in contact with the system. Ensure no hazardous voltages remain on any accessible before handling any part of the instrument and test setup, making connections to the system, removing covers or cleaning the instrument.

WARNING

High Energy Sources: The Analog Buses are designed to handle inputs up to their rated currents or their rated powers, whichever is less. Under certain fault conditions, high energy sources could provide substantially more current or power than the instrument can handle. It is important to provide external current limiting, such as fuses if the inputs are connected to high-energy sources. The overcurrent protection is to be rated for the maximum available short circuit current of the hazardous sources. Ensure that the current limiting devices / snubber circuits are appropriate for the signal being tested. Failure to do so may result in hazardous conditions such as fire or shock and could lead to personal injury or death. Refer to [34980A Current Limiting Graphs](#) for the current limiting graphs of 34890A.

WARNING

Do not connect the Analog Buses directly to a mains power outlet. If it is necessary to measure a mains voltage or any circuit where a large inductive load may be switched, you must add signal conditioning elements to reduce the potential transients before they reach the Analog Buses. Refer to User's Guide for the maximum rated transients for each external source.

WARNING

When working with dangerous voltage levels, intentionally closing of multiple bus and channel relays could cause a potentially lethal hazard on external connections. Use extreme caution when handling and testing and adjusting this instrument. Do not perform these procedures unless qualified to do so. Failure to recognize and observe normal safety precautions could result in personal injury or death.

WARNING

No operator serviceable parts inside. Do not install substitute parts or perform any unauthorized modifications to the instrument. Return the instrument to Keysight for service and repair to ensure the safety features are maintained in operational condition. Instruments that appear damaged or defective should be made inoperative and secured against unintended operation.

WARNING

To prevent electrical shock, disconnect the instrument from mains and external circuits before cleaning. Use a dry cloth or one slightly dampened with water (or 70% Isopropyl Alcohol) to clean the external case parts. Do not attempt to clean internally. Allow any moisture to evaporate prior to energizing the instrument.

WARNING

This product is designed for use in INSTALLATION CATEGORY II and POLLUTION DEGREE 1 and 2 (See module specifications for ratings for each Pollution Degree environment).

WARNING

The AC Voltage source (outlet) must be in proper working order and provide a secure electrical connection. Do not use the outlet if the power cord makes a loose connection or if the power cord plug does not match the outlet. Do not use the outlet if it is damaged or if the voltage is outside the required range.

WARNING

Do not use adapters or extension cords. These devices may not be sufficiently rated to carry the required current and become a safety hazard.

WARNING

ENVIRONMENTAL HEALTH & SAFETY: When any channel is connected to a hazardous voltage source, the instrument and the device under test should be supervised, following local EHS practices to restrict access.

WARNING

CAUTION WITH HAZARDOUS VOLTAGES: When any channel is connected to a hazardous voltage source, all channels in the module should be treated as hazardous and all channel wiring in the module should be rated for the maximum voltage applied. Thermocouples attached to any other channel on the module should have insulation rated for the maximum voltage, or have additional insulation added rated for the maximum voltage and should be isolated from conductive parts using a thermal compound or tape rated for the maximum voltage applied. Do not mount, move or remove any thermocouples when the device under test is connected to a supply source.









Environmental Conditions

Keysight 34980A is designed for indoor use in an installation category II and low condensation environment. Table below shows the general environmental conditions for this instrument. Refer to the product data sheet at <https://literature.cdn.keysight.com/litweb/pdf/5989-1437EN.pdf> for more information on the instrument general specifications.

General specifications	Requirement
Temperature	Operating condition: 0°C to 55°C Storage condition: -40°C to 70°C
Humidity	Maximum Relative Humidity (non-condensing): 80% RH up to 40°C, decreases linearly to 37% RH at 55°C ^[a]
Altitude	Up to 2,000 m
Pollution degree	1 or 2

[a] From 40°C to 55°C, the maximum % Relative Humidity follows the line of constant dew point.

Regulatory Markings

 <p>The CE mark is a registered trademark of the European Community. This CE mark shows that the product complies with all the relevant European Legal Directives.</p>	 <p>The CSA mark is a registered trademark of the Canadian Standards Association.</p>
 <p>The UK conformity mark is a UK government owned mark. Products showing this mark comply with all applicable UK regulations.</p>	 <p>The Keysight email address is required by EU directives applicable to our product.</p>
<p>CAN ICES/NMB-001(A)</p> <p>This indicates that this ISM device complies with the Canadian ICES-001. Interference-Causing Equipment Standard for industrial, scientific and medical (ISM) equipment. Matériel industriel, scientifique et médical (ISM)</p>	<p>ISM 1-A</p> <p>This is a symbol of an Industrial Scientific and Medical Group 1 Class A product. (CISPR 11, Clause 5)</p>
 <p>The CE mark is a registered trademark of the European Community. This CE mark shows that the product complies with all the relevant European Legal Directives.</p> <p>ICES/NMB-001 indicates that this ISM device complies with the Canadian ICES-001.</p> <p>Cet appareil ISM est conforme à la norme NMB-001 du Canada.</p> <p>ISM GRP:1 Class A indicates that this is an Industrial Scientific and Medical Group 1 Class A product.</p>	 <p>This is a combined marking to indicate product compliance with the Industry Canadian Interference-Causing Equipment Standard (ICES/NMB-001). This is also a symbol of an Industrial Scientific and Medical Group 1 Class A product (CISPR 11, Clause 5).</p>
 <p>This symbol is a South Korean Class A EMC Declaration. This is a Class A instrument suitable for professional use and in electromagnetic environment outside of the home.</p>	 <p>The RCM mark is a registered trademark of the Australian Communications and Media Authority.</p>



This symbol indicates the time period during which no hazardous or toxic substance elements are expected to leak or deteriorate during normal use. Forty years is the expected useful life of the product.



This instrument complies with the WEEE Directive (2002/96/EC) marking requirement. This affixed product label indicates that you must not discard this electrical or electronic product in domestic household waste.



Universal recycling symbol.

IP x y

This mark indicates product has been designed to meet the requirements of "IP x y", where "x" is the solid particle protection and "y" is the liquid ingress protection.

Waste Electrical and Electronic Equipment (WEEE) Directive 2002/96/EC

The crossed out wheeled bin symbol indicates that separate collection for waste electric and electronic equipment (WEEE) is required, as obligated by the EU DIRECTIVE and other National legislation.

Please refer to [keysight.com/go/takeback](https://www.keysight.com/go/takeback) to understand your Trade in options with Keysight in addition to product takeback instructions.



Sales and Technical Support

To contact Keysight for sales and technical support, refer to the support links on the following Keysight websites:

- www.keysight.com/find/34980a
(product-specific information and support, software and documentation updates)
- www.keysight.com/find/assist
(worldwide contact information for repair and service)

THIS PAGE HAS BEEN INTENTIONALLY LEFT BLANK.

Table of Contents

Safety Symbols	3
Additional Safety Notices	4
Environmental Conditions	10
Regulatory Markings	11
Waste Electrical and Electronic Equipment (WEEE) Directive 2002/96/EC	13
Sales and Technical Support	13
Low Frequency Multiplexer Modules	17
Multiplexer Module Capabilities	17
Measurement Functions for the Multiplexer Modules	18
Operating Considerations	19
SCPI Programming Examples for the Multiplexer Modules	21
34921A 40-Channel Armature Multiplexer with Low Thermal Offset	25
34921A Simplified Schematic	27
34921A D-Sub Connectors	28
34921T Terminal Block	30
34922A 70-Channel Armature Multiplexer	34
34922A Simplified Schematic	35
34922A D-Sub Connectors	36
34922T Terminal Blocks	38
34923A 40/80-Channel Reed Multiplexer	44
Two-Wire Mode	45
Four-Wire Mode	45
One-Wire Mode	46
34923A Simplified Schematic for Two- or Four-Wire Mode	47
34923A D-Sub Connectors for Two- or Four-Wire Mode	48
34923T-001 Terminal Block for Two-Wire or Four-Wire Mode	50
34923A Simplified Schematic for One-Wire Mode	53
34923A D-Sub Connectors for One-Wire Mode	54
34923T-002 Terminal Block for One-Wire Mode	56
34924A 70-Channel Reed Multiplexer	59

34924A Simplified Schematic	61
34924A D-Sub Connectors	62
34924T Terminal Blocks	64
34925A 40/80-Channel Optically-Isolated FET Multiplexer	70
Two-Wire Mode	70
Four-Wire Mode	71
One-Wire Mode	71
Interlock Protection	71
Overvoltage Protection	72
34925A Simplified Schematic for Two- or Four-Wire Mode	73
34925A D-Sub Connectors for Two- or Four-Wire Mode	74
34925T-001 Terminal Block for Two-Wire or Four-Wire Mode	77
34925A Simplified Schematic for One-Wire Mode	80
34925A D-Sub Connectors for One-Wired Mode	81
34925T-002 Terminal Block for One-Wire Mode	83
34980A Current Limiting Graphs	86

Low Frequency Multiplexer Modules

This User's Guide covers the following five plug-in modules for the Keysight 34980A Multifunction Switch/Measure Unit:

34921A	40-channel armature multiplexer w/low thermal offset
34922A	70-channel armature multiplexer
34923A	40/80-channel reed multiplexer
34924A	70-channel reed multiplexer
34925A	40-channel optically isolated FET multiplexer

Multiplexer Module Capabilities

Each multiplexer (MUX) module features two banks of channels, providing broad multiplexing and measurement capabilities. Briefly:

- You can connect a MUX to an external instrument, and/or switch multiple analog signals to the internal DMM.
- With the 34921A, 34922A, 34923A, and the 34924A modules, you can close more than one channel in each bank simultaneously ($N:1$ configuration).
- Since the 34925A module is protected with overvoltage circuitry, you can close only one channel in each bank at one time ($1:N$ configuration).
- You can connect multiple MUXes to the built-in Analog Buses, which allow you to scan as many as 560 2-wire (differential) channels or 640 1-wire (single-ended) channels in one 34980A mainframe.

Measurement Functions for the Multiplexer Modules

The MUX modules support the DMM measurement functions shown in the following table.

Measurement Function(s)	34921A 40-ch Armature Mux	34922A 70-ch Armature Mux	34923A 40-ch Reed Mux (2-Wire)	34923A 80-ch Reed Mux (1-Wire)	34924A 70-ch Reed Mux	34925A 40-ch FET Mux (2-Wire)	34925A 80-ch FET Mux (1-Wire)
Voltage, AC/DC	Yes	Yes	Yes	Yes	Yes	Yes	Yes
Current, AC/DC	Yes ^a	No	No	No	No	No	No
Frequency/Period	Yes	Yes	Yes	Yes	Yes	Yes	Yes
Ohms 2-Wire	Yes	Yes	Yes ^e	Yes ^e	Yes ^e	Yes ^f	Yes ^f
Ohms 4-Wire	Yes	Yes	Yes ^e	No	Yes ^e	Yes ^f	No
Thermocouple	Yes ^b	Yes ^c	Yes ^{c,d}	Yes ^{c,d}	Yes ^{c,d}	Yes ^c	Yes ^c
RTD 2-Wire	Yes	Yes	Yes ^e	Yes ^e	Yes ^e	No	No
RTD 4-Wire	Yes	Yes	Yes ^e	No	Yes ^e	Yes ^f	No
Thermistor	Yes	Yes	Yes ^e	Yes ^e	Yes ^e	No	No

[a] Direct current measurements are allowed on channels 41 through 44 only (for all other channels, external shunts are required).

[b] Optional 34921T Terminal Block is required for thermocouple measurements with built-in internal reference junction.

[c] A fixed or external reference junction temperature is required for thermocouple measurement with this module.

[d] Impact of higher offset voltage specification ($< 50 \mu\text{V}$) must be taken into consideration.

[e] 1 k Ω or higher range used unless 100 Ω series resistors are bypassed on module.

[f] 10 k Ω or higher range used for loads over approximately 300 Ω due to series resistance of FET channels.

Operating Considerations

Current Ratings

See the *Introduction to the Plug In Modules* chapter of the 34980A Mainframe User's Guide for detailed environmental operating conditions for the 34980A mainframe and its installed modules. That guidance sets maximum per channel current ratings or rated power, whichever is less, at rated voltage for pollution degree 1 (dry) and pollution degree 2 (possible condensation) conditions, for all of the multiplexer modules.

Safety Interlock

The Analog Buses of the 34980A are capable of carrying 300V signals. The MUX modules have a hardware *Safety Interlock* feature that automatically opens the Analog Bus relays when the associated interlock pins on the D-sub connectors (faceplate) lose continuity. This prevents signals on the Analog Buses from being present on the D-sub connector pins. Optional terminal blocks available from Keysight automatically provide continuity for these interlock pins. If cables are used, you must provide continuity for the interlock pins in your DUT assembly. See the pinout information later in this guide for the location of interlock pins on each module.

The MUX modules have Analog Bus relays on each of their two banks. Therefore, the interlock pins are present on both the Bank 1 and Bank 2 D-sub connectors on the MUX modules.

Normally, if you attempt to connect to the Analog Buses without a terminal block or cable connected, an error is generated. The **SYSTEM:ABUS:INTerlock:SIMulate** command allows you to temporarily disable errors generated by the Safety Interlock feature and enables the simulation mode. Although Safety Interlock errors are suppressed in this mode, the actual Analog Bus relays affected by the Safety Interlock are disabled as long as no terminal block or cable is connected to the module.

CAUTION

The Safety Interlock feature is implemented in hardware on the modules and cannot be circumvented. Regardless of whether the simulation mode is enabled or disabled, all Analog Bus connections are prohibited as long as no terminal block or properly-wired cable is connected to the module.

- The simulation mode applies to the entire mainframe and cannot be selectively used on individual modules.
- When the simulation mode is enabled, the Analog Bus relays will *appear* to close and open as directed. For example, no errors are generated if you close an Analog Bus relay from the front panel, remote interface, or Web Interface. However, remember that the Safety Interlock feature prevents the actual hardware state of the Analog Bus relays from being changed. When you connect a terminal block or cable to the module, the Analog Bus relays will be closed.
- The simulation setting is stored in volatile memory and will be lost when power is turned off. To re-enable the simulation mode after power has been off, you must send the command again.

SCPI Programming Examples for the Multiplexer Modules

The programming examples below provide you with SCPI command examples to use for actions specific to the MUX modules.

The slot and channel addressing scheme used in these examples follow the form **sccc** where **s** is the mainframe slot number (1 through 8) and **ccc** is the three-digit channel number. For information on specific MUX channel configurations, refer to the simplified schematics contained in each MUX section of this manual.

For complete information on the SCPI commands used to program the 34980A, with example programs, refer to the *Keysight 34980A Programmer's Reference* which can be downloaded from www.keysight.com/find/34980A.

Opening and Closing Channels

Example: Closing and opening channels on the armature and reed MUX modules This command closes the specified channels on a MUX module. If any channel in a bank is defined to be part of the scan list, and a scan is occurring, attempting to close another channel (including Analog Bus channels) within the same bank will result in an error. Channel closures in the other bank are allowed as long as no channels are part of the scan list.

The following commands close and open channels 13 and 15 through 18 in slot 3.

```
ROUTE:CLOSe (@3013,3015:3018)
ROUTE:OPEN (@3013,3015:3018)
```

Example: Closing channels on the FET MUX module The FET MUX module supports a 1:N type closure, meaning that you can have only one channel per bank closed at a time. The following command closes then automatically opens each channel from 1-19 (Bank 1) in succession, leaving channel 20 closed. Then the command continues closing and opening channels 21 to 39 (Bank 2), then leaving channel 40 closed. At the end, only channels 20 and 40 will be closed, while all other channels will have been closed and then opened. In this process, a channel will open before the next channel in succession closes, making this a “break-before-make” series.

```
ROUTE:CLOSe (@3001:3040)
```

The following command opens the closed channel on Bank 1 of a FET MUX module in slot 3, and closes channel 15 on that bank.

```
ROUTE:CLOSe (@3015)
```

Example: Closing and opening Analog Bus relays The following command connects the Analog Buses to Bank 1 (via the Analog Bus relays on Bank 1) for a module in slot 3.

```
ROUTE:CLOSe (@3911,3912,3913,3914)
ROUTE:OPEN (@3911,3912,3913,3914)
```

The Analog Bus relays (numbered s911, s912, s913, etc.) on the MUX modules are ignored if they are included in a range of channels. An error will be generated if an Analog Bus relay is specified as the first or last channel in a range of channels. For example, the following command closes all valid channels between channel 30 (slot 1) and channel 5 (slot 2). In addition, this command closes Analog Bus relay 911 on the module in slot 1 (Bank 1). Note that although the specified range of channels includes the other Analog Bus relays, they are ignored and are not closed by this command.

```
ROUTE:CLOSe (@1030:2005,1911)
```

Example: Querying channels for open or close state The following command returns a 1 (true) or 0 (false) state of channel 036 for a module in slot 3.

```
ROUTE:CLOSe (@3036)
ROUTE:CLOSe? (@3036) !Returns a 1
ROUTE:OPEN? (@3036) !Returns a 0
```

Making Measurements

Example: Making voltage measurements The following command configures channels 9 and 10 in slot 4 for DC voltage measurements, triggers the internal DMM to scan channels 9 and 10, and returns the reading. The 1 V range is selected with 1 mV resolution.

```
MEASure:VOLTage:DC? 1,0.001, (@4009,4010)
```

Example: Making voltage measurements using INITiate and FETCh?

The following program segment shows how to use the **INITiate** command with the **CONFigure** and **FETCh?** commands. The **ROUTE:SCAN** command puts channels 3 and 8 (of a module in slot 1) into the scan list (and redefines the scan list). The **INITiate** command scans the specified channels, and then sends the readings to memory. The **FETCh?** command transfers the readings from memory to the user.

```
CONFigure:VOLTage:DC 10,0.003,(@1003,1008)
ROUTE:SCAN (@1003,1008)
INITiate
FETCh?
```

Example: Making current measurements The following command configures channel 43 for a 34921A modules in slot 7 for dc current measurements, triggers the internal DMM to scan the channel, and then sends the reading to the output buffer of the 34980A. The default settings for range (autorange) and resolution (1 PLC) are used for the measurement.

```
MEASure:CURRent:DC? (@7043)
```

Configuring a Module

Example: Configuring a module for 2-wire or 1-wire mode The following command configures a MUX module in slot 4 for 1-wire mode. Because you can configure only the 34923A and 34925A MUX modules (and the 34933A matrix module) for either 2-wire or 1-wire mode, an error is generated if you send this command to a slot that does not contain one of those three modules. If you are using terminal blocks with these modules, be sure to use the corresponding 2-wire or 1-wire terminal block.

```
SYSTem:MODuLe:WIRE:MODE WIRE1,4
```

NOTE

When using a command to configure the system, the new configuration does not take effect until you cycle power on the 34980A.

Example: Querying the system for module Identify The following command returns the identity of the module installed in slot 7.

```
SYSTem:CTYPe? 7
```

NOTE

For the 34923A and the 34925A MUX modules, the query response may include a suffix to indicate a 1-wire configuration. For example, the response for the 34923A will be either "34923A" (differential mode) or "34923A-1W" (single-ended mode).

Querying and Clearing Cycle Count, and Resetting Modules

Example: Querying the cycle count for a relay The following command returns the cycle count on channel 7 and channel 16 for a MUX module in slot 1.

```
DIAGnostic:RELAY:CYCLes? (@1007,1016)
```

NOTE

The 34925A will return 0 for relay counts because the FET relays on that module are non-mechanical and have an undefined lifetime.

Example: Clearing the cycle count for a relay The following command resets the cycle count to zero on the channels 7 and 16 for a MUX module in slot 1.

```
DIAGnostic:RELAY:CYCLes:CLEAr (@1007,1016)
```

Example: Resetting module(s) to power-on state The following command resets a module in slot 4 to its power-on state.

```
SYSTem:CPON 4
```

34921A 40-Channel Armature Multiplexer with Low Thermal Offset

The 34921A 40-Channel Armature Multiplexer (40-Ch Arm MUX) is divided into two banks with 20 latching armature switches (channels 1-20 and 21-40) in each. This module also offers four additional fused relays (channels 41-44) for making AC and DC current measurements with the internal DMM with no external shunts needed. These current channels feature “make-before-break” connections to ensure continuous current flow when switching from one current channel to another. The current fuses are replaceable at servicing at Keysight only. Refer to the *34980A Service Guide* for specific information about these fuses.

This module also contains nine armature Analog Bus relays (channels 911-914, 921-924, and 931), four on each bank that can connect the bank relays to the system Analog Buses and one that connects the current relays to the current input of the DMM. Through ABus1 and ABus2 you can connect any of the channels to the internal DMM for voltage or resistance measurements. Refer to the simplified schematic on [page 27](#).

NOTE

ABus1 consists of three wires that are used for current and voltage measurements. A separate current bus on ABus1 connects to the internal DMM current measurement input and this bus can be connected only to channels 41 through 44. The current channel low (L) signal path is common with the ABus1 low (L) signal path. You cannot measure current and voltage on ABus1 simultaneously.

Using program commands or the mainframe front panel, you can control each of the channel switches individually, and thus configure the 34921A module in these modes:

- two independent 20-channel 2-wire MUXes. This configuration requires neither using external wiring nor connecting through the internal Analog Buses.
- one 20-channel 4-wire MUX. This configuration requires neither using external wiring nor connecting through the internal Analog Buses. For 4-wire resistance measurements, the instrument automatically pairs channel n on Bank 1 (source) with channel $n+20$ on Bank 2 (sense) to provide these connections. Four-wire controls occur only when doing 4-wire measurement operations through the internal DMM, such as **MEASure:FRESistance?** or scanning a channel previously configured as 4-wire.

- one 40-channel 2-wire MUX. You must use external wiring or connect through the internal Analog Bus relays for this configuration. For example, closing Analog Bus channels 913 and 923 connects Bank 1 and Bank 2 through ABus3. Or, externally you can connect COM1 to COM2 to create this configuration.

Low thermal offset voltage makes the 34921A ideal for low-level signal switching. The 34921T optional terminal block provides a built-in thermocouple reference junction that helps minimize errors due to thermal offset when you measure thermocouples.

This module has capability to scan as many as 100 channels/second using the internal DMM. With the automatic “break-before-make” connection operation, you are assured that no two signals are connected to each other during a scan. When using the module in a non-scanning mode, you can close as many channels as you wish.

This module is safety interlock protected, which means whenever the D-sub connector end of the modules is exposed, the Analog Bus relays automatically open and disconnect from the Analog Bus. For more information, see “[Safety Interlock](#)” on page 19 and “[34921A D-Sub Connectors](#)” on page 28.

When power is off, all channel relays maintain state, and the Analog Bus relays open.

34921A Simplified Schematic

This drawing shows two independent 20-channel 2-wire MUXes.

NOTE: The three-digit number assigned to each switch represents the channel number.

NOTE:

Bank Relays: Armature latching

Analog Bus Relays: Armature non-latching

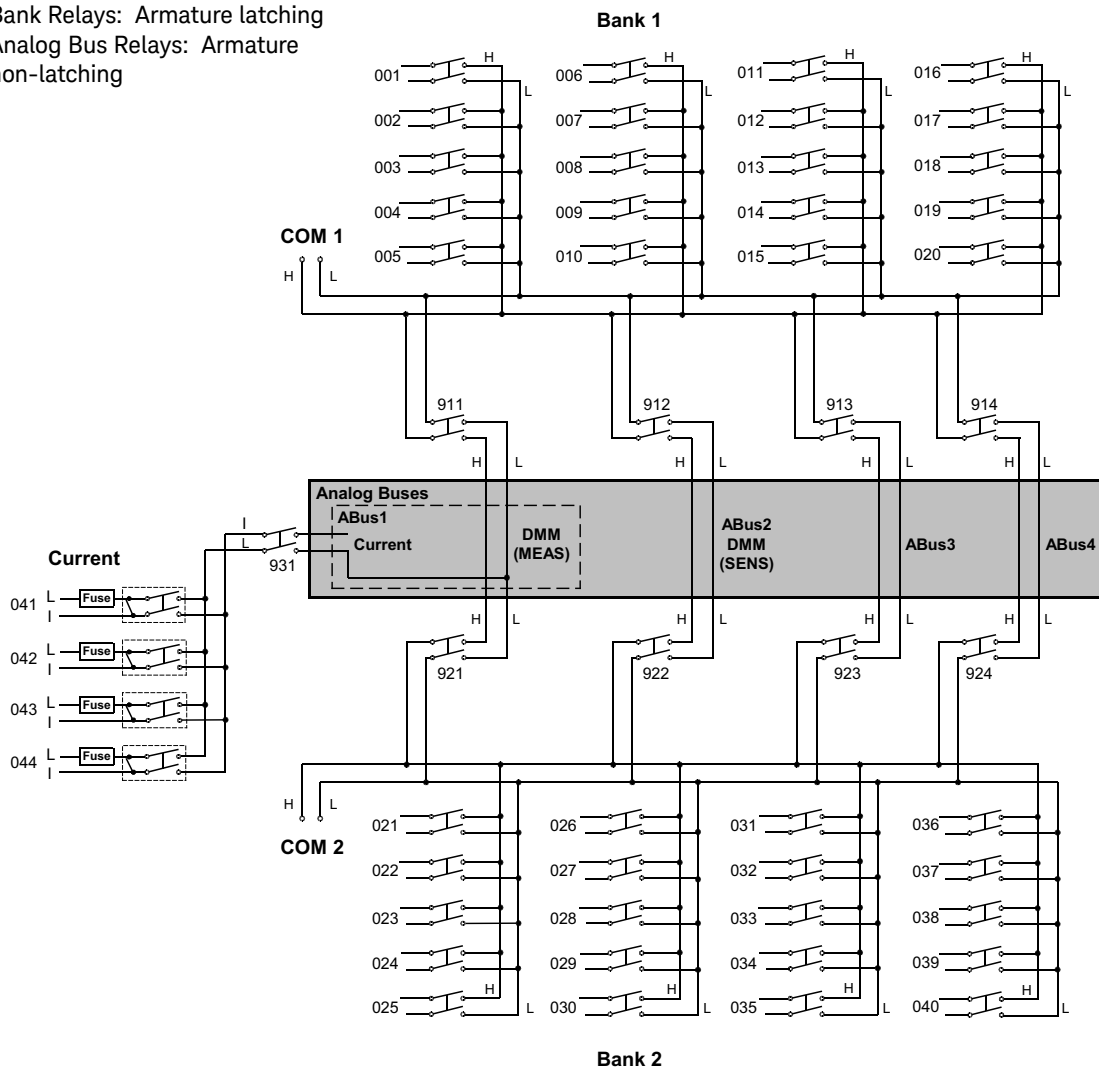

34921A D-Sub Connectors

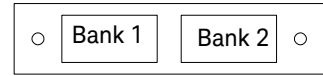

For orientation, the D-sub connector end of the module is facing you.

Bank 1

*TSIL = Temperature Sensor Interface Line. Provides thermocouple reference sensor serial output line to the mainframe processor.

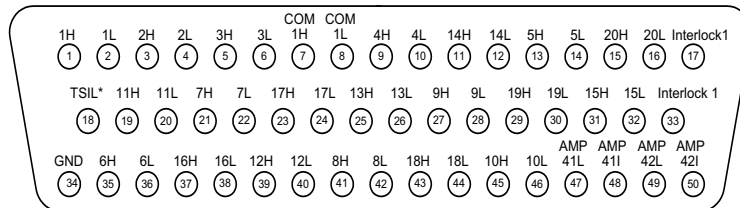

50-Pin
D-Sub Male
Connector

Description	Pin	Description	Pin	Description	Pin	Description	Pin	Description	Pin
1H	1	6H	35	11H	19	16H	37	COM1 H	7
1L	2	6L	36	11L	20	16L	38	COM1 L	8
2H	3	7H	21	12H	39	17H	23	Interlock 1	17
2L	4	7L	22	12L	40	17L	24	Interlock 1	33
3H	5	8H	41	13H	25	18H	43	GND	34
3L	6	8L	42	13L	26	18L	44	TSIL*	18
4H	9	9H	27	14H	11	19H	29	AMP 41L	47
4L	10	9L	28	14L	12	19L	30	AMP 41I	48
5H	13	10H	45	15H	31	20H	15	AMP 42L	49
5L	14	10L	46	15L	32	20L	16	AMP 42I	50

WARNING

As a safety feature, interlock 1 pins (17 and 33) on Bank 1 must be shorted to enable the Bank 1 Analog Bus relays to close. The optional 34921T terminal block shorts these pins for you. This feature protects inadvertent routing of high voltages from the Analog Bus to the D-sub connector of the module.

Bank 2

*TSIL = Temperature Sensor Interface Line. Provides thermocouple reference sensor serial output line to the mainframe processor.

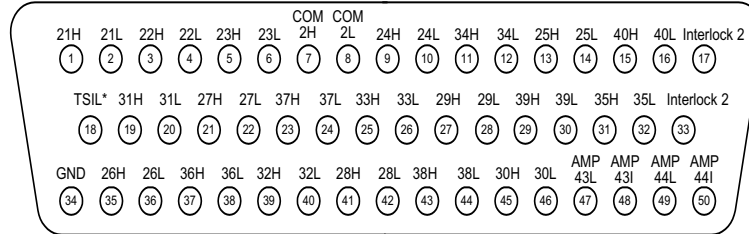

50-Pin
D-Sub Male
Connector

Description	Pin	Description	Pin	Description	Pin	Description	Pin	Description	Pin
21H	1	26H	35	31H	19	36H	37	COM2 H	7
21L	2	26L	36	31L	20	36L	38	COM2 L	8
22H	3	27H	21	32H	39	37H	23	Interlock 2	17
22L	4	27L	22	32L	40	37L	24	Interlock 2	33
23H	5	28H	41	33H	25	38H	43	GND	34
23L	6	28L	42	33L	26	38L	44	TSIL*	18
24H	9	29H	27	34H	11	39H	29	AMP 43L	47
24L	10	29L	28	34L	12	39L	30	AMP 43I	48
25H	13	30H	45	35H	31	40H	15	AMP 44L	49
25L	14	30L	46	35L	32	40L	16	AMP 44I	50

WARNING

As a safety feature, interlock 2 pins (17 and 33) on Bank 2 must be shorted to enable the Bank 2 Analog Bus relays to close. The optional 34921T terminal block shorts these pins for you. This feature protects inadvertent routing of high voltages from the Analog Bus to the D-sub connector of the module.

34921T Terminal Block

This terminal block with screw-type connections is labeled with the model number and the abbreviated module name. In addition, space is available on the label for you to write the slot number.

NOTE

All modules that connect to the internal DMM are interlock protected. This means that when an installed module is exposed (no terminal block or cable is connected), the Analog Bus relays are open and disconnected from the Analog Buses. See **“Safety Interlock”** on page 19 for further information.

The 34921T is the only terminal block that provides an isothermal block with temperature reference for thermocouple measurements. The temperature sensor is located on the bottom side of the PC board as shown below. Also shown are two holes that you can use for connecting an external temperature reference to the terminal block.

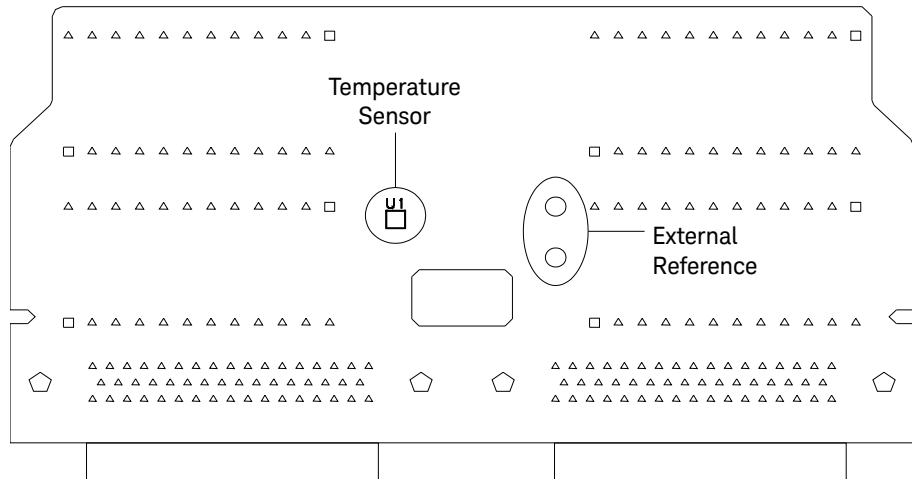

34921T (viewed from bottom side)

CAUTION

When wiring the terminal block via cables to the mainframe, make sure the cables are connected to the correct connector. The cables provide communication and power to the temperature sensor on the 34921T terminal block. If cabling is not correct, an error may occur indicating that the 34921A module is not fully operational.

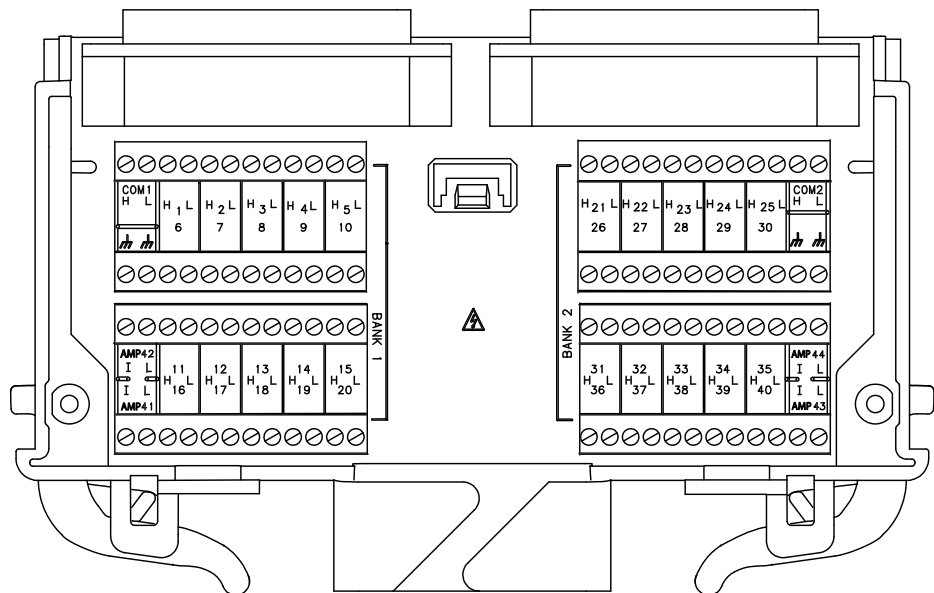

WARNING

Terminal block wiring: Failure to follow the instructions below could result in equipment damage and may result in hazardous conditions such as fire or shock and could lead to personal injury or death.

Wiring of the terminal block must be performed by qualified persons. A MAXIMUM of 5 mm of conductor insulation is to be removed. All wire strands must be appropriately inserted in the connector housing. The screw connections must be sufficiently secured to prevent accidental loosening.

Never operate the instrument without the terminal block covers securely installed. Use caution to prevent operators from accessing any external circuits, test fixtures, cables or whenever hazardous voltages may be present.

WARNING**External Wiring for Hazardous Voltages:**

To ensure minimum safety insulation when wiring with hazardous voltages, ensure all wiring (both internal and external to the instruments):

- follow (USA) NFPA 79 Table 12.5.1 Conductor Ampacity and 12.5.5(a) Ambient Temperature Correction Factors (or equivalent National Code requirements) when selecting the AWG required.
 - are rated for at least 2 x the maximum applied voltage of the external source or any interconnecting system modules or external connections.
 - flame rated minimum:
 - Wires and cables with overall cross-sectional area of the conductors exceeding 0.5mm^2 meet test of IEC 60332-1-2 (IEC); or
 - Wires and cables with overall cross-sectional area of the conductors of 0.5mm^2 or less, the test of IEC 60332-2-2 (IEC); or
 - FT-1 of CSA C22.2 No. 0.3 (Canada); or
 - VW-1 of UL 1581 (US).
 - temperature rated for the application.
 - classified and suitable to be used external to the enclosure:
 - AWM Class II B or A/B – external/interconnecting wires (single- or multiple-conductor constructions with a jacket) and potentially subject to mechanical abuse (Canada)
 - AWM Style Use – external interconnection of electronic equipment or appliances (US)
-

34922A 70-Channel Armature Multiplexer

The high-density 34922A 70-Channel Armature Multiplexer (70-Ch Arm MUX) is divided into two banks with 35 latching armature switches (channels 1-35 and 36-70) in each. This module also contains eight armature Analog Bus relays (channels 911-914 and 921-924), four on each bank that can connect the bank relays to the system Analog Buses. Through ABus1 and ABus2 you can connect any of the channels to the internal DMM for voltage or resistance measurements. Refer to the simplified schematic on [page 35](#).

Using program commands or the mainframe front panel, you can control each of the channel switches individually, and thus configure the 34922A in these modes:

- two independent 35-channel 2-wire MUXes. This configuration requires neither using external wiring nor connecting through the internal Analog Buses.
- one 35-channel 4-wire MUX. This configuration requires neither using external wiring nor connecting through the internal Analog Buses. For 4-wire resistance measurements, the instrument automatically pairs channel n on Bank 1 (source) with channel $n+35$ on Bank 2 (sense) to provide these connections. Four-wire controls occur only when doing 4-wire measurement operations through the internal DMM, such as **MEASure:FRESistance?** or scanning a channel previously configured as 4-wire.
- one 70-channel 2-wire MUX. You must use external wiring or connect through the internal Analog Bus relays for this configuration. For example, closing Analog Bus channels 913 and 923 connects Bank 1 and Bank 2 through ABus3. Or, externally you can connect COM1 to COM2 to create this configuration.

This module has capability to scan as many as 100 channels/second using the internal DMM. With the automatic “break-before-make” connection operation, you are assured that no two signals are connected to each other during a scan. When using the module in a non-scanning mode, you can close as many channels as you wish.

This module is interlock protected, which means whenever the D-sub connector end of the modules is exposed, the Analog Bus relays automatically open and disconnect from the Analog Bus. For more information, see [“Safety Interlock”](#) on page 19 and [“34922A D-Sub Connectors”](#) on page 36.

When the power is off, all channel relays maintain state, and the Analog Bus relays open.

34922A Simplified Schematic

This drawing shows two independent 35-channel 2-wire MUXes.

NOTE: The three-digit number assigned to each switch represents the channel number.

NOTE:

Bank Relays: Armature latching

Analog Bus Relays: Armature non-latching

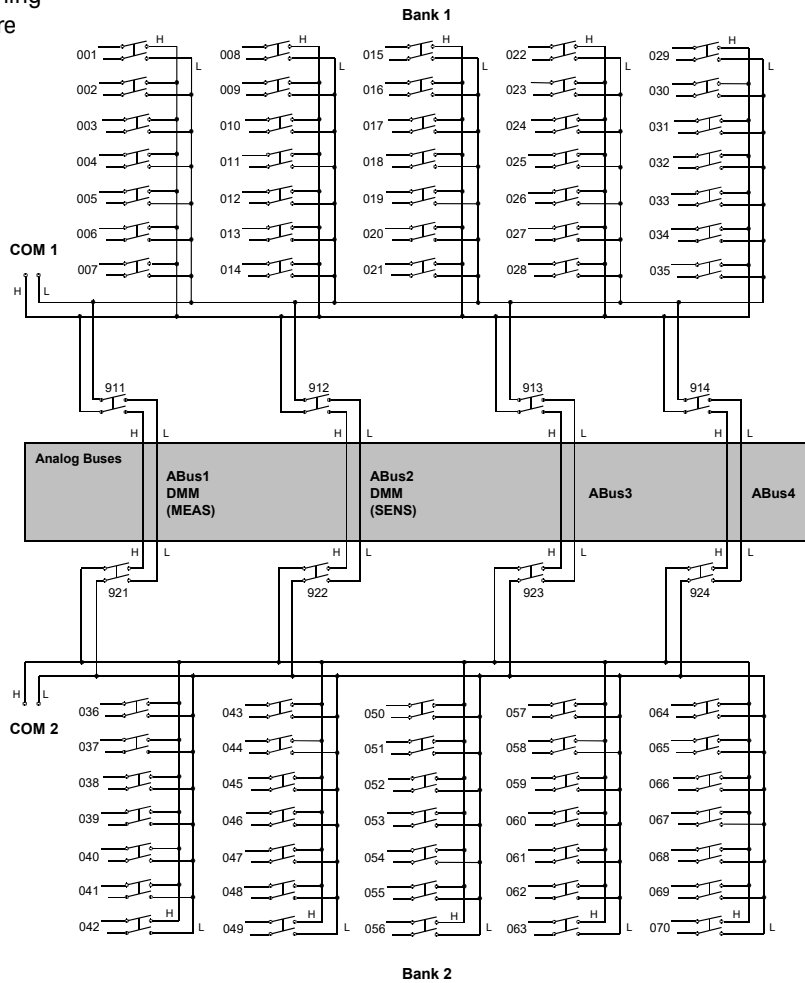

34922A D-Sub Connectors

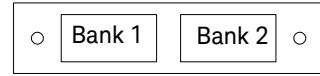

For orientation, the D-sub connector end of the module is facing you.

Bank 1

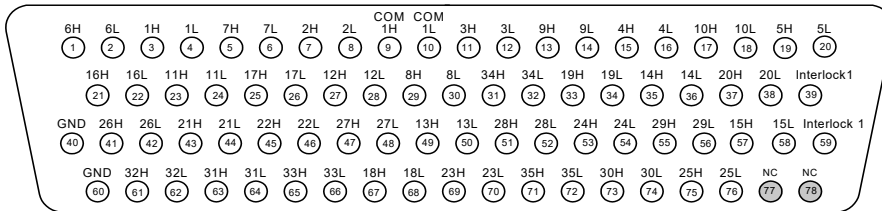

78-Pin D-Sub Male Connector

Description	Pin	Description	Pin	Description	Pin	Description	Pin	Description	Pin	Description	Pin
1H	3	8H	29	15H	57	22H	45	29H	55	COM1 H	9
1L	4	8L	30	15L	58	22L	46	29L	56	COM1 L	10
2H	7	9H	13	16H	21	23H	69	30H	73	Interlock 1	39
2L	8	9L	14	16L	22	23L	70	30L	74	Interlock 1	59
3H	11	10H	17	17H	25	24H	53	31H	63	GND	40
3L	12	10L	18	17L	26	24L	54	31L	64	GND	60
4H	15	11H	23	18H	67	25H	75	32H	61	No Connect	77
4L	16	11L	24	18L	68	25L	76	32L	62	No Connect	78
5H	19	12H	27	19H	33	26H	41	33H	65		
5L	20	12L	28	19L	34	26L	42	33L	66		
6H	1	13H	49	20H	37	27H	47	34H	31		
6L	2	13L	50	20L	38	27L	48	34L	32		
7H	5	14H	35	21H	43	28H	51	35H	71		
7L	6	14L	36	21L	44	28L	52	35L	72		

WARNING

As a safety feature, interlock 1 pins (39 and 59) on Bank 1 must be shorted to enable the Bank 1 Analog Bus relays to close. The optional 34922T terminal blocks short these pins for you. This feature protects inadvertent routing of high voltages from the Analog Buses to the D-sub connector of the module.

Bank 2

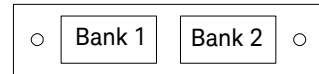

For orientation, the D-sub connector end of the module is facing you.

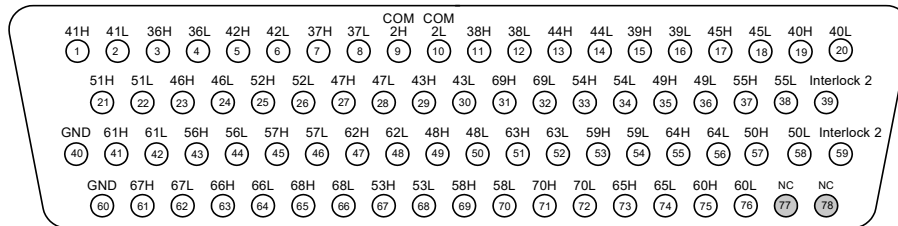

78-Pin D-Sub Male Connector

Description	Pin	Description	Pin	Description	Pin	Description	Pin	Description	Pin	Description	Pin
36H	3	43H	29	50H	57	57H	45	64H	55	COM2 H	9
36L	4	43L	30	50L	58	57L	46	64L	56	COM2 L	10
37H	7	44H	13	51H	21	58H	69	65H	73	Interlock 2	39
37L	8	44L	14	51L	22	58L	70	65L	74	Interlock 2	59
38H	11	45H	17	52H	25	59H	53	66H	63	GND	40
38L	12	45L	18	52L	26	59L	54	66L	64	GND	60
39H	15	46H	23	53H	67	60H	75	67H	61	No Connect	77
39L	16	46L	24	53L	68	60L	76	67L	62	No Connect	78
40H	19	47H	27	54H	33	61H	41	68H	65		
40L	20	47L	28	54L	34	61L	42	68L	66		

Description	Pin	Description	Pin	Description	Pin	Description	Pin	Description	Pin	Description	Pin
41H	1	48H	49	55H	37	62H	47	69H	31		
41L	2	48L	50	55L	38	62L	48	69L	32		
42H	5	49H	35	56H	43	63H	51	70H	71		
42L	6	49L	36	56L	44	63L	52	70L	72		

WARNING

As a safety feature, interlock 2 pins (39 and 59) on Bank 2 must be shorted to enable the Bank 2 Analog Bus relays to close. The optional 34922T terminal blocks short these pins for you. This feature protects inadvertent routing of high voltages from the Analog Buses to the D-sub connector of the module.

34922T Terminal Blocks

Two terminal blocks are available to facilitate wiring connections to the 34922A module:

34922T-001 (Option 001)	Terminal block with solder connectors
34922T-002 (Option 002)	Terminal block with screw connectors

NOTE

All modules that connect to the internal DMM are interlock protected. This means that when an installed module is exposed (no terminal block or cable is connected), the Analog Bus relays are open and disconnected from the Analog Buses. See **“Safety Interlock”** on page 19 for further information.

34922T-001 Terminal Block

This terminal block with solder-type connections is labeled with the model number and the abbreviated module name. In addition, space is available on the label for you to write the slot number.

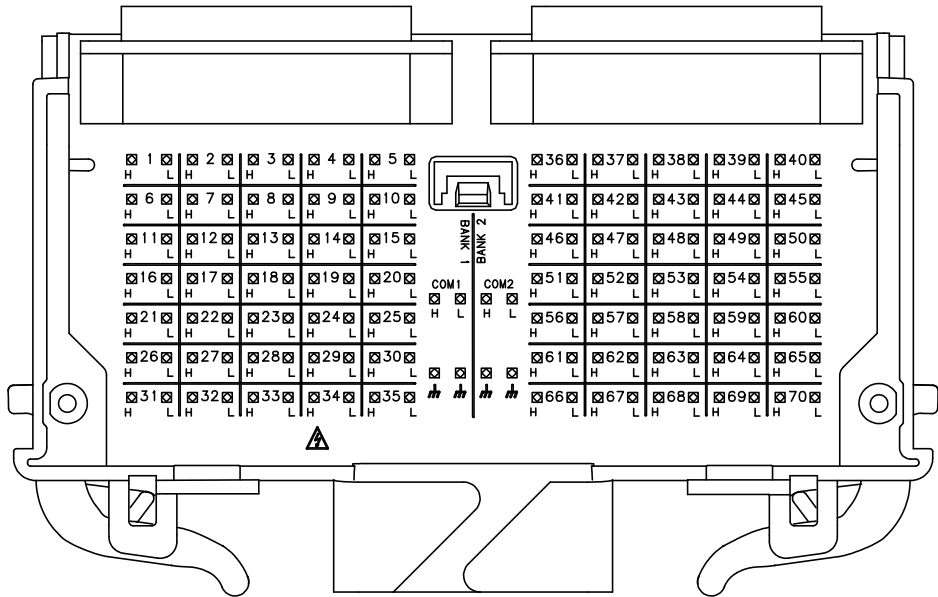

WARNING

Terminal block wiring: Failure to follow the instructions below could result in equipment damage and may result in hazardous conditions such as fire or shock and could lead to personal injury or death.

Wiring of the terminal block must be performed by qualified persons. A **MAXIMUM** of 5 mm of conductor insulation is to be removed. All wire strands must be appropriately inserted in the connector housing. The screw connections must be sufficiently secured to prevent accidental loosening.

Never operate the instrument without the terminal block covers securely installed. Use caution to prevent operators from accessing any external circuits, test fixtures, cables or whenever hazardous voltages may be present.

WARNING**External Wiring for Hazardous Voltages:**

To ensure minimum safety insulation when wiring with hazardous voltages, ensure all wiring (both internal and external to the instruments):

- follow (USA) NFPA 79 Table 12.5.1 Conductor Ampacity and 12.5.5(a) Ambient Temperature Correction Factors (or equivalent National Code requirements) when selecting the AWG required.
 - are rated for at least 2 x the maximum applied voltage of the external source or any interconnecting system modules or external connections.
 - flame rated minimum:
 - Wires and cables with overall cross-sectional area of the conductors exceeding 0.5mm^2 meet test of IEC 60332-1-2 (IEC); or
 - Wires and cables with overall cross-sectional area of the conductors of 0.5mm^2 or less, the test of IEC 60332-2-2 (IEC); or
 - FT-1 of CSA C22.2 No. 0.3 (Canada); or
 - VW-1 of UL 1581 (US).
 - temperature rated for the application.
 - classified and suitable to be used external to the enclosure:
 - AWM Class II B or A/B – external/interconnecting wires (single- or multiple-conductor constructions with a jacket) and potentially subject to mechanical abuse (Canada)
 - AWM Style Use – external interconnection of electronic equipment or appliances (US)
-

34922T-002 Terminal Block

This terminal block with screw-type connections is labeled with the model number and the abbreviated module name. In addition, space is available on the label for you to write the slot number.

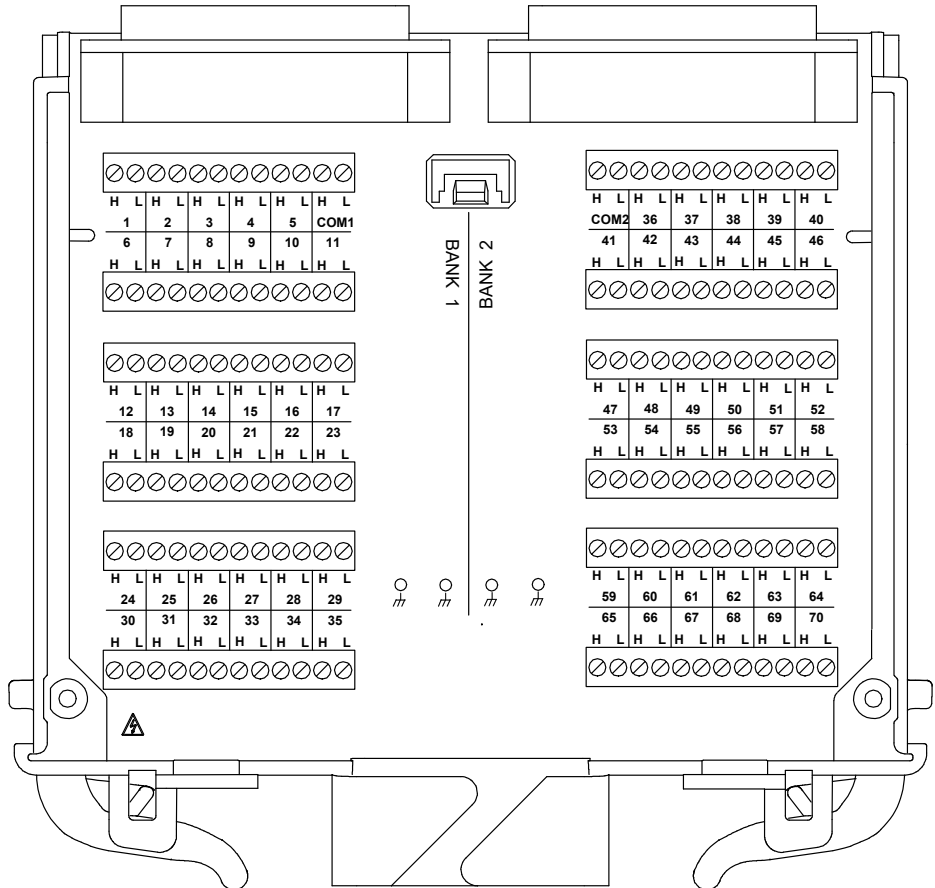

WARNING

Terminal block wiring: Failure to follow the instructions below could result in equipment damage and may result in hazardous conditions such as fire or shock and could lead to personal injury or death.

Wiring of the terminal block must be performed by qualified persons. A **MAXIMUM** of 5 mm of conductor insulation is to be removed. All wire strands must be appropriately inserted in the connector housing. The screw connections must be sufficiently secured to prevent accidental loosening.

Never operate the instrument without the terminal block covers securely installed. Use caution to prevent operators from accessing any external circuits, test fixtures, cables or whenever hazardous voltages may be present.

WARNING**External Wiring for Hazardous Voltages:**

To ensure minimum safety insulation when wiring with hazardous voltages, ensure all wiring (both internal and external to the instruments):

- follow (USA) NFPA 79 Table 12.5.1 Conductor Ampacity and 12.5.5(a) Ambient Temperature Correction Factors (or equivalent National Code requirements) when selecting the AWG required.
 - are rated for at least 2 x the maximum applied voltage of the external source or any interconnecting system modules or external connections.
 - flame rated minimum:
 - Wires and cables with overall cross-sectional area of the conductors exceeding 0.5mm^2 meet test of IEC 60332-1-2 (IEC); or
 - Wires and cables with overall cross-sectional area of the conductors of 0.5mm^2 or less, the test of IEC 60332-2-2 (IEC); or
 - FT-1 of CSA C22.2 No. 0.3 (Canada); or
 - VW-1 of UL 1581 (US).
 - temperature rated for the application.
 - classified and suitable to be used external to the enclosure:
 - AWM Class II B or A/B – external/interconnecting wires (single- or multiple-conductor constructions with a jacket) and potentially subject to mechanical abuse (Canada)
 - AWM Style Use – external interconnection of electronic equipment or appliances (US)
-

34923A 40/80-Channel Reed Multiplexer

The 34923A 40/80-Channel Reed Multiplexer (40/80-Ch Reed MUX) is divided into two equal banks of non-latching reed switches. This module also contains eight armature Analog Bus relays (channels 911-914 and 921-924), four on each bank that can connect the bank relays to the system Analog Buses. You can connect any of the channels to the internal DMM through ABus1 and ABus2 for voltage or resistance measurements.

Using program commands or the mainframe front panel, you can control each of the channel switches individually, and configure this module for differential (2-wire or 4-wire) or single-ended (1-wire) mode. Refer to the simplified schematics on [page 47](#) and [page 53](#).

If you are using an Keysight 34923T-00x terminal block to connect your DUT to this module, be sure to use the terminal block that corresponds to your module configuration mode (Refer to the terminal block drawings on [page 50](#) and [page 56](#)):

34923T-001 (Option 001)	Terminal block for differential (two- or four-wire) mode
34923T-002 (Option 002)	Terminal block for single-ended (1-wire) mode

You can confirm the mode in which your module is configured by using the **SYSTem:CTYPe? <slot number>** program command. This command returns the identity of the plug-in module in the specified slot.

NOTE

Whenever you change from 2- or 4-wire mode to 1-wire mode, or the reverse, you must cycle power on the 34980A for the configuration to take effect.

In all modes, this module has capability to scan as many as 500 channels/second using the internal DMM. With the automatic “break-before-make” connection operation, you are assured that no two signals are connected to each other during a scan.

This module is interlock protected, which means whenever the D-sub connector end of the modules is exposed, the Analog Bus relays immediately open and disconnect from the Analog Bus. For more information, see “[Safety Interlock](#)” on [page 19](#) and the D-Sub connector drawings on [page 48](#) and [page 54](#).

CAUTION

Because user-attached reactive loads and backplane parasitic capacitance may result in high in-rush currents, 100 Ω in-rush resistors protect the reed relays from damage and performance degradation. Therefore, you must consider these resistors when you are designing a measurement. Refer to the simplified schematics on [page 47](#) and [page 53](#).

Lifetime of relays is severely degraded as current or voltage goes up. If higher voltage is being switched, limits on source current are recommended. When the power is off, all channel and Analog Bus relays open.

Two-Wire Mode

You may configure the 34923A as:

- two independent 20-channel 2-wire MUXes. This configuration requires neither the use of external wiring nor connection through the internal Analog Buses.
- one 40-channel, 2-wire MUX. For this configuration, you *must* use external wiring or connect through the internal Analog Buses.

In 2-wire mode, you can close no more than 20 channels simultaneously due to power dissipation. These 20 channels are split 10 to a bank. However, note that Analog Bus relays count half as much as channel relays in that total. For example, with one Analog Bus relay closed, you can close up to a maximum of 19 channel relays. If you try to close more than the allowed number of channels, you will receive an error message.

Four-Wire Mode

You may configure the 34923A as a 20-channel 4-wire MUX. This configuration requires neither external wiring nor connection through the Analog Buses.

For 4-wire resistance measurements, the instrument automatically pairs channel n on Bank 1 (source) with channel $n+20$ on Bank 2 (sense) to provide these connections. Four-wire controls occur only when doing 4-wire measurement operations through the internal DMM, such as **MEASure:FRESistance?** or scanning a channel previously configured as 4-wire.

One-Wire Mode

You may configure the 34923A as:

- two independent 40-channel 1-wire MUXes. This configuration requires neither external wiring nor connection through the internal Analog Buses.
- one 80-channel 1-wire MUX. You must use external wiring or connect through the internal Analog Bus for this configuration.

NOTE

Because all bank relays supply only HI signals, you can apply a LOW signal through COM1 L or COM2 L when you are making 2-wire resistance measurements in 1-wire mode.

In 1-wire mode, you can close no more than 40 channels simultaneously due to power dissipation. These channels are split 20 to a bank. For example, with one Analog Bus relay closed you can close up to a maximum of 39 channel relays. If you try to close more than the allowed number of channels, you will receive an error message.

34923A Simplified Schematic for Two- or Four-Wire Mode

This drawing shows two independent 20-channel 2-wire MUXes. To change configuration modes, use the **SYSTEM:MODULE:WIRE:MODE** command.

NOTE: The three-digit number assigned to each switch represents the channel number.

NOTE:

Bank Relays: Reed non-latching

Analog Bus Relays: Armature non-latching

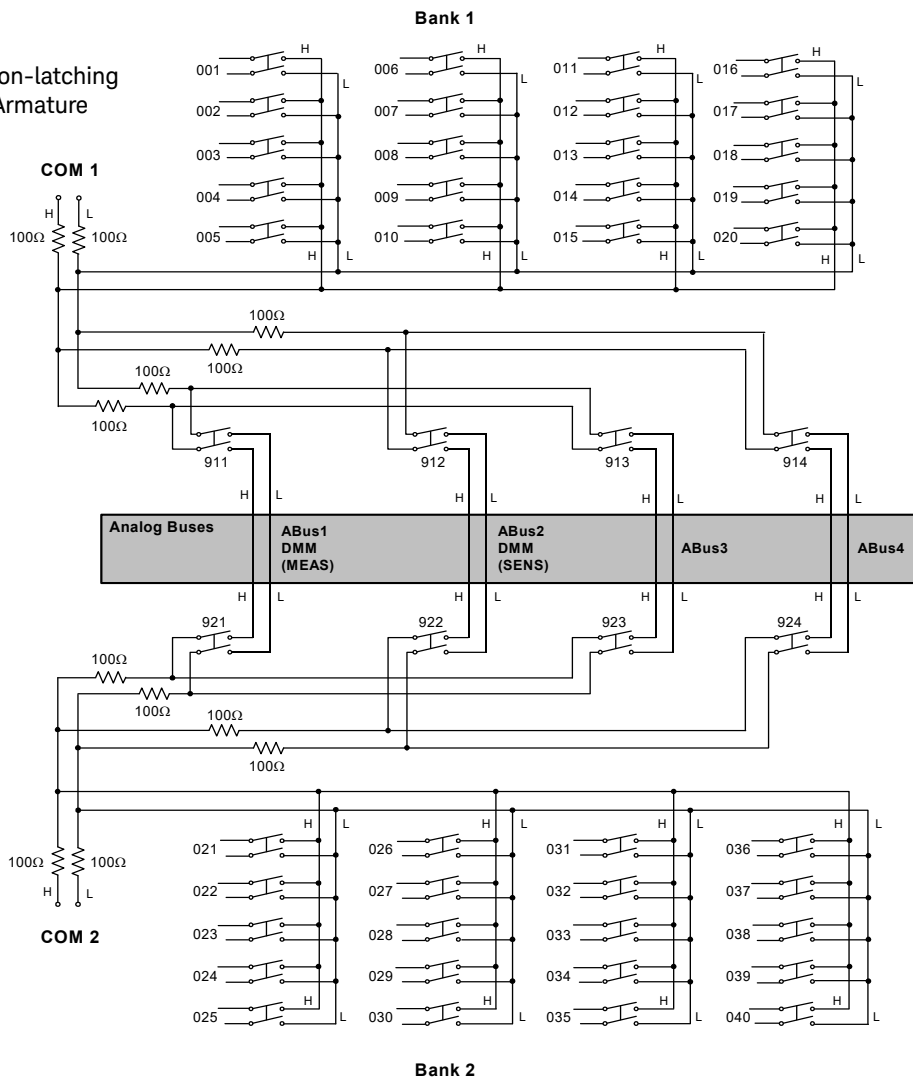

34923A D-Sub Connectors for Two- or Four-Wire Mode

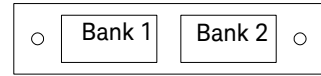

For orientation, the D-sub connector end of the module is facing you.

Bank 1

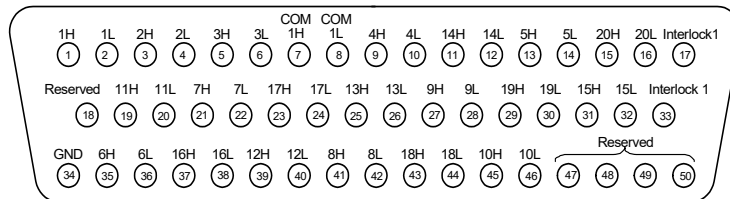

50-Pin D-Sub Male Connector

Description	Pin	Description	Pin	Description	Pin	Description	Pin	Description	Pin
1H	1	6H	35	11H	19	16H	37	COM1 H	7
1L	2	6L	36	11L	20	16L	38	COM1 L	8
2H	3	7H	21	12H	39	17H	23	Interlock 1	17
2L	4	7L	22	12L	40	17L	24	Interlock 1	33
3H	5	8H	41	13H	25	18H	43	GND	34
3L	6	8L	42	13L	26	18L	44	Reserved	18
4H	9	9H	27	14H	11	19H	29	Reserved	47
4L	10	9L	28	14L	12	19L	30	Reserved	48
5H	13	10H	45	15H	31	20H	15	Reserved	49
5L	14	10L	46	15L	32	20L	16	Reserved	50

WARNING

As a safety feature, interlock 1 pins (17 and 33) on Bank 1 must be shorted to enable the Bank 1 Analog Bus relays to close. The optional 34923T-001 (for 2-wire) terminal block shorts these pins for you. This feature protects inadvertent routing of high voltages from the Analog Bus to the D-sub connector of the module.

Bank 2

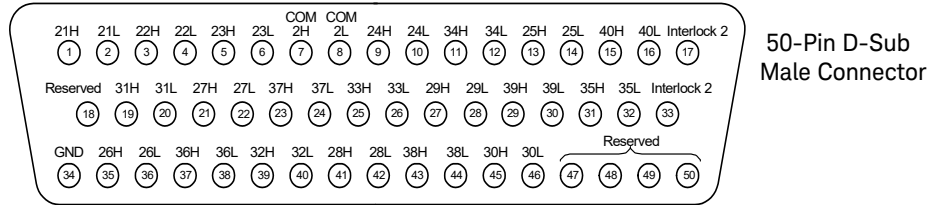

50-Pin D-Sub
Male Connector

Description	Pin	Description	Pin	Description	Pin	Description	Pin	Description	Pin
21H	1	26H	35	31H	19	36H	37	COM2 H	7
21L	2	26L	36	31L	20	36L	38	COM2 L	8
22H	3	27H	21	32H	39	37H	23	Interlock 2	17
22L	4	27L	22	32L	40	37L	24	Interlock 2	33
23H	5	28H	41	33H	25	38H	43	GND	34
23L	6	28L	42	33L	26	38L	44	Reserved	18
24H	9	29H	27	34H	11	39H	29	Reserved	47
24L	10	29L	28	34L	12	39L	30	Reserved	48
25H	13	30H	45	35H	31	40H	15	Reserved	49
25L	14	30L	46	35L	32	40L	16	Reserved	50

WARNING

As a safety feature, interlock 2 pins (17 and 33) on Bank 2 must be shorted to enable the Bank 2 Analog Bus relays to close. The optional 34923T-001 (for 2-wire) shorts these pins for you. This feature protects inadvertent routing of high voltages from the Analog Buses to the D-sub connector of the module.

34923T-001 Terminal Block for Two-Wire or Four-Wire Mode

This terminal block with screw-type connections is labeled with the model number and the abbreviated module name. In addition, space is available on the label for you to write the slot number.

NOTE

All modules that connect to the internal DMM are interlock protected. This means that when an installed module is exposed (no terminal block or cable is connected), the Analog Bus relays are open and disconnected from the Analog Buses. See **“Safety Interlock”** on page 19 for further information.

NOTE

If you are using an Keysight terminal block to connect your DUT to this module be sure to use the 34923T-001 terminal block that corresponds to the 2- or 4-wire configuration mode. An error will not be generated if you have installed a terminal block that doesn't match the present module configuration.

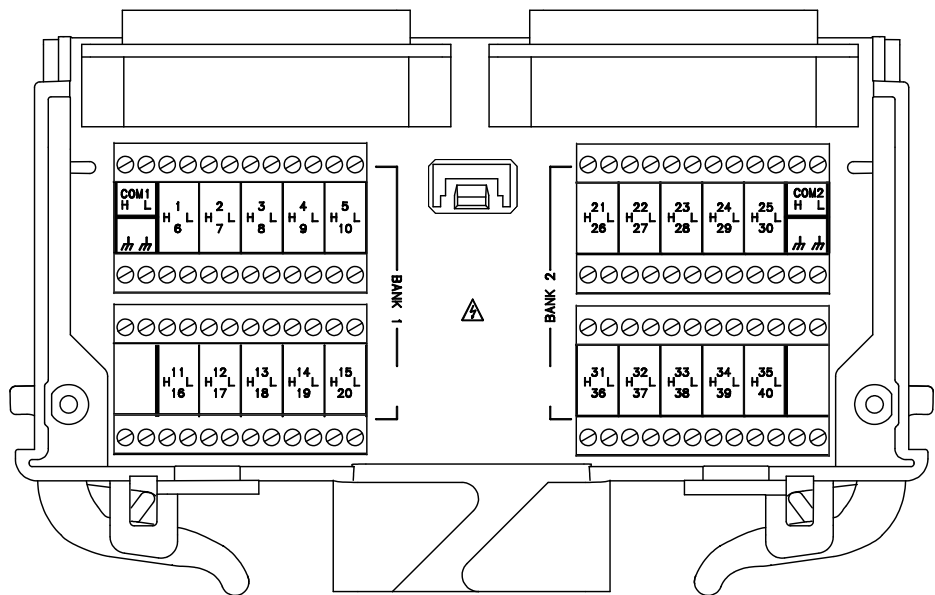

WARNING

Terminal block wiring: Failure to follow the instructions below could result in equipment damage and may result in hazardous conditions such as fire or shock and could lead to personal injury or death.

Wiring of the terminal block must be performed by qualified persons. A MAXIMUM of 5 mm of conductor insulation is to be removed. All wire strands must be appropriately inserted in the connector housing. The screw connections must be sufficiently secured to prevent accidental loosening.

Never operate the instrument without the terminal block covers securely installed. Use caution to prevent operators from accessing any external circuits, test fixtures, cables or whenever hazardous voltages may be present.

WARNING**External Wiring for Hazardous Voltages:**

To ensure minimum safety insulation when wiring with hazardous voltages, ensure all wiring (both internal and external to the instruments):

- follow (USA) NFPA 79 Table 12.5.1 Conductor Ampacity and 12.5.5(a) Ambient Temperature Correction Factors (or equivalent National Code requirements) when selecting the AWG required.
 - are rated for at least 2 x the maximum applied voltage of the external source or any interconnecting system modules or external connections.
 - flame rated minimum:
 - Wires and cables with overall cross-sectional area of the conductors exceeding 0.5mm^2 meet test of IEC 60332-1-2 (IEC); or
 - Wires and cables with overall cross-sectional area of the conductors of 0.5mm^2 or less, the test of IEC 60332-2-2 (IEC); or
 - FT-1 of CSA C22.2 No. 0.3 (Canada); or
 - VW-1 of UL 1581 (US).
 - temperature rated for the application.
 - classified and suitable to be used external to the enclosure:
 - AWM Class II B or A/B – external/interconnecting wires (single- or multiple-conductor constructions with a jacket) and potentially subject to mechanical abuse (Canada)
 - AWM Style Use – external interconnection of electronic equipment or appliances (US)
-

34923A Simplified Schematic for One-Wire Mode

This drawing shows two independent 40-channel 1-wire MUXes. To change configuration modes, use the **SYSTem:MODUle:WIRE:MODE** command.

NOTE: The three-digit number assigned to each switch represents the channel number.

NOTE:

Bank relays: Reed non-latching

Analog Bus relays: Armature non-latching

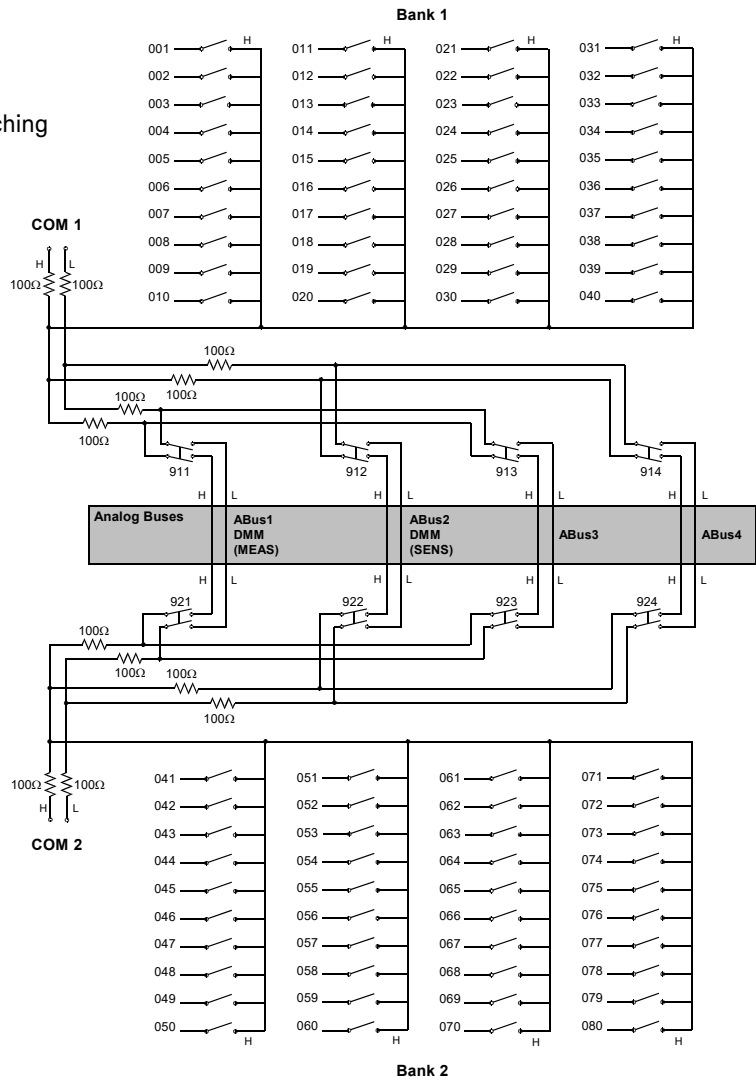

34923A D-Sub Connectors for One-Wire Mode

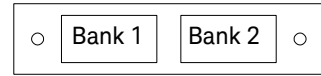

For orientation, the D-sub connector end of the module is facing you.

Bank 1

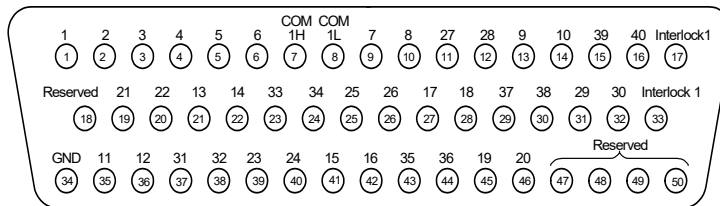

50-Pin D-Sub Male Connector

Description	Pin	Description	Pin	Description	Pin	Description	Pin	Description	Pin
1	1	11	35	21	19	31	37	COM1 H	7
2	2	12	36	22	20	32	38	COM1 L	8
3	3	13	21	23	39	33	23	Interlock 1	17
4	4	14	22	24	40	34	24	Interlock 1	33
5	5	15	41	25	25	35	43	GND	34
6	6	16	42	26	26	36	44	Reserved	18
7	9	17	27	27	11	37	29	Reserved	47
8	10	18	28	28	12	38	30	Reserved	48
9	13	19	45	29	31	39	15	Reserved	49
10	14	20	46	30	32	40	16	Reserved	50

WARNING

As a safety feature, interlock 1 pins (17 and 33) on Bank 1 must be shorted to enable the Bank 1 Analog Bus relays to close. The optional 34923T-002 (for 1-wire) shorts these pins for you. This feature protects inadvertent routing of high voltages from the Analog Bus to the D-sub connector of the module.

Bank 2

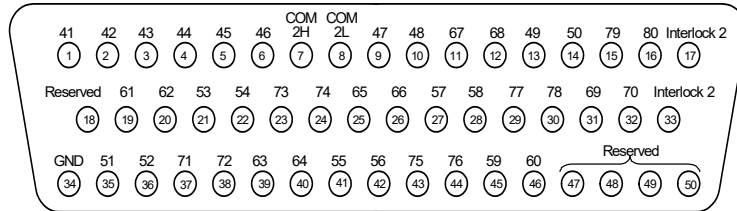

50-Pin D-Sub
Male Connector

Description	Pin	Description	Pin	Description	Pin	Description	Pin	Description	Pin
41	1	51	35	61	19	71	37	COM2 H	7
42	2	52	36	62	20	72	38	COM2 L	8
43	3	53	21	63	39	73	23	Interlock 2	17
44	4	54	22	64	40	74	24	Interlock 2	33
45	5	55	41	65	25	75	43	GND	34
46	6	56	42	66	26	76	44	Reserved	18
47	9	57	27	67	11	77	29	Reserved	47
48	10	58	28	68	12	78	30	Reserved	48
49	13	59	45	69	31	79	15	Reserved	49
50	14	60	46	70	32	80	16	Reserved	50

WARNING

As a safety feature, interlock 2 pins (17 and 33) on Bank 2 must be shorted to enable the Bank 2 Analog Bus relays to close. The optional 34923T-002 (for 1-wire) shorts these pins for you. This feature protects inadvertent routing of high voltages from the Analog Buses to the D-sub connector of the module.

34923T-002 Terminal Block for One-Wire Mode

This terminal block with screw-type connections is labeled with the model number and the abbreviated module name. In addition, space is available on the label for you to write the slot number.

NOTE

All modules that connect to the internal DMM are interlock protected. This means that when an installed module is exposed (no terminal block or cable is connected), the Analog Bus relays are open and disconnected from the Analog Buses. See **“Safety Interlock”** on page 19 for further information.

NOTE

If you are using an Keysight terminal block to connect your DUT to this module be sure to use the 34923T-002 terminal block that corresponds to the 1-wire configuration mode. An error will not be generated if you have installed a terminal block that doesn't match the present module configuration.

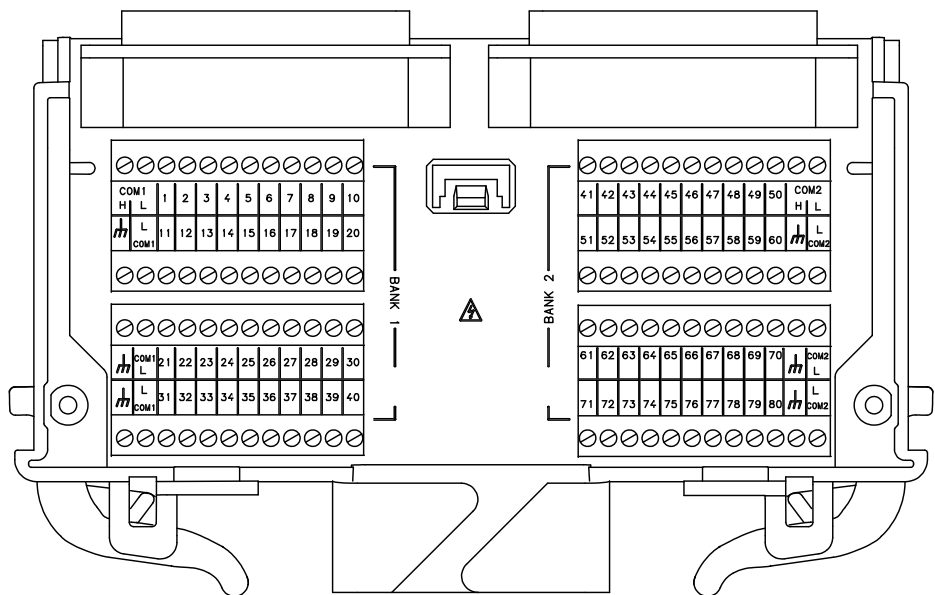

WARNING

Terminal block wiring: Failure to follow the instructions below could result in equipment damage and may result in hazardous conditions such as fire or shock and could lead to personal injury or death.

Wiring of the terminal block must be performed by qualified persons. A MAXIMUM of 5 mm of conductor insulation is to be removed. All wire strands must be appropriately inserted in the connector housing. The screw connections must be sufficiently secured to prevent accidental loosening.

Never operate the instrument without the terminal block covers securely installed. Use caution to prevent operators from accessing any external circuits, test fixtures, cables or whenever hazardous voltages may be present.

WARNING**External Wiring for Hazardous Voltages:**

To ensure minimum safety insulation when wiring with hazardous voltages, ensure all wiring (both internal and external to the instruments):

- follow (USA) NFPA 79 Table 12.5.1 Conductor Ampacity and 12.5.5(a) Ambient Temperature Correction Factors (or equivalent National Code requirements) when selecting the AWG required.
 - are rated for at least 2 x the maximum applied voltage of the external source or any interconnecting system modules or external connections.
 - flame rated minimum:
 - Wires and cables with overall cross-sectional area of the conductors exceeding 0.5mm^2 meet test of IEC 60332-1-2 (IEC); or
 - Wires and cables with overall cross-sectional area of the conductors of 0.5mm^2 or less, the test of IEC 60332-2-2 (IEC); or
 - FT-1 of CSA C22.2 No. 0.3 (Canada); or
 - VW-1 of UL 1581 (US).
 - temperature rated for the application.
 - classified and suitable to be used external to the enclosure:
 - AWM Class II B or A/B – external/interconnecting wires (single- or multiple-conductor constructions with a jacket) and potentially subject to mechanical abuse (Canada)
 - AWM Style Use – external interconnection of electronic equipment or appliances (US)
-

34924A 70-Channel Reed Multiplexer

The high-density 34924A 70-Channel Reed Multiplexer (70-Ch Reed MUX) is divided into two banks with 35 non-latching reed switches (channels 1-35 and 36-70) in each. This module also contains eight armature Analog Bus relays (channels 911-914 and 921-924), four on each bank that can connect the bank relays to the system Analog Buses. Through ABus1 and ABus2 you can connect any of the channels to the system DMM for voltage or resistance measurements. See the simplified schematic on [page 61](#).

Using program commands or the mainframe front panel, you can control each of the channel switches individually, and thus configure the 34924A in any of these modes:

- two independent 35-channel 2-wire MUXes. This configuration requires neither using external wiring nor connecting through the internal Analog Buses.
- one 70-channel, 2-wire MUX. You must use external wiring or connect through the internal Analog Buses for this configuration.
- one 35-channel 4-wire MUX. This configuration requires neither using external wiring nor connecting through the internal Analog Buses. For 4-wire resistance measurements, the instrument automatically pairs channel n on Bank 1 (source) with channel $n+35$ on Bank 2 (sense) to provide these connections. Four-wire controls occur only when doing 4-wire measurement operations through the internal DMM, such as **MEASure:FRESistance?** or scanning a channel previously configured as 4-wire.

In 2-wire mode, you can close no more than 20 channels simultaneously due to power dissipation. These 20 channels are split 10 to a bank. However, note that Analog Bus relays count half as much as channel relays in that total. For example, with one Analog Bus relay closed, you can close up to a maximum of 19 channel relays. If you try to close more than the allowed number of channels, you will receive an error message.

In all modes, this module has capability to scan as many as 500 channels/second using the internal DMM. With the automatic “break-before-make” connection operation, you are assured that no two signals are connected to each other during a scan.

CAUTION

Because user-attached reactive loads and backplane parasitic capacitance may result in high in-rush currents, 100 Ω in-rush resistors protect the reed relays from damage and performance degradation. Therefore, you must consider these resistors when you are designing a measurement. Refer to the simplified schematic on [page 61](#).

This module is interlock protected, which means whenever the D-sub connector end of the modules is exposed, the Analog Bus relays immediately open and disconnect from the Analog Bus. For more information, see [“Safety Interlock”](#) on page 19.

Lifetime of relays is severely degraded as current or voltage goes up. If higher voltage is being switched, limits on source current are recommended.

When the power is off, all channel and Analog Bus relays open.

34924A Simplified Schematic

This drawing shows two independent 35-channel 2-wire MUXes.

NOTE: The three-digit number assigned to each switch represents the channel number.

NOTE:

Bank relays: Reed non-latching

Analog Bus relays: Armature non-latching

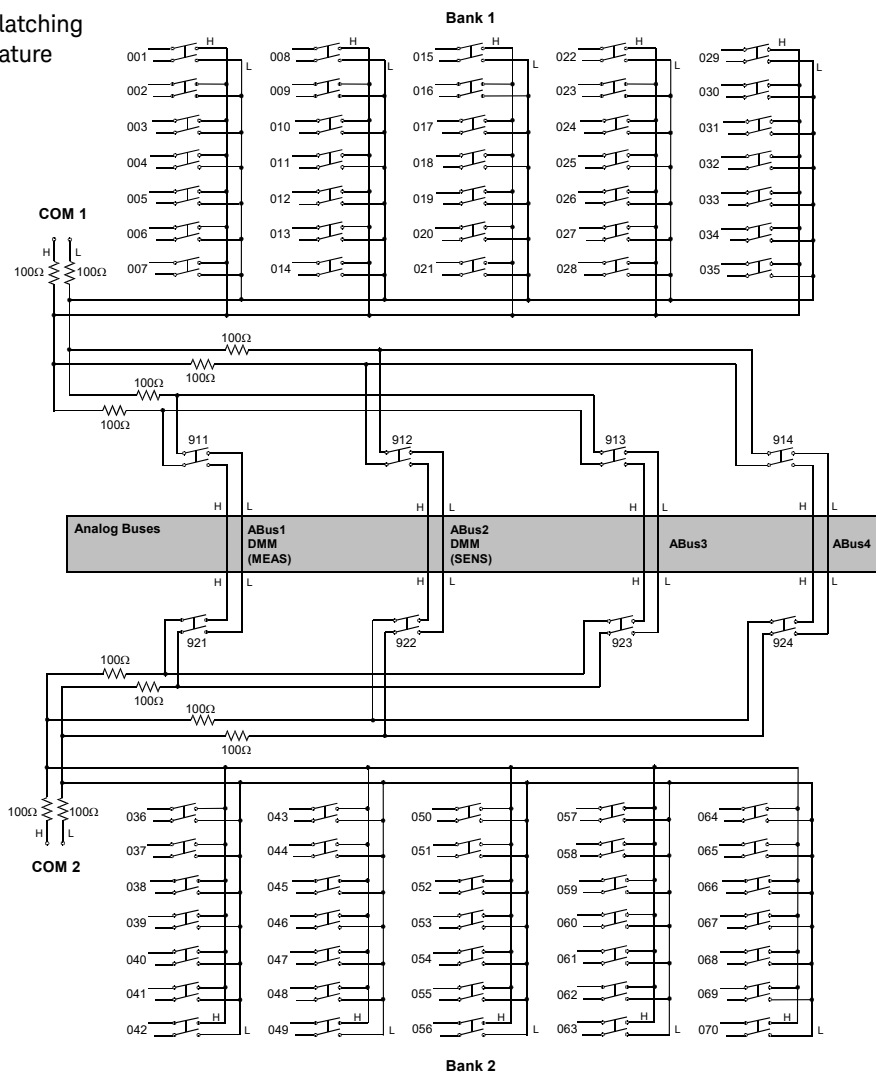

34924A D-Sub Connectors

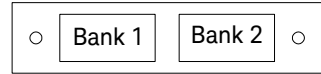

For orientation, the D-sub connector end of the module is facing you.

Bank 1

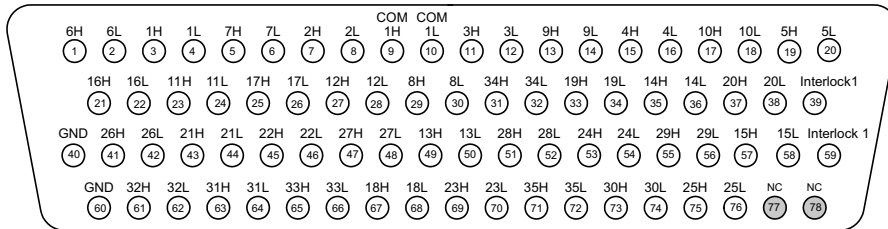

78-Pin D-Sub Male Connector

Description	Pin	Description	Pin	Description	Pin	Description	Pin	Description	Pin	Description	Pin
1H	3	8H	29	15H	57	22H	45	29H	55	COM1 H	9
1L	4	8L	30	15L	58	22L	46	29L	56	COM1 L	10
2H	7	9H	13	16H	21	23H	69	30H	73	Interlock 1	39
2L	8	9L	14	16L	22	23L	70	30L	74	Interlock 1	59
3H	11	10H	17	17H	25	24H	53	31H	63	GND	40
3L	12	10L	18	17L	26	24L	54	31L	64	GND	60
4H	15	11H	23	18H	67	25H	75	32H	61	No Connect	77
4L	16	11L	24	18L	68	25L	76	32L	62	No Connect	78
5H	19	12H	27	19H	33	26H	41	33H	65		
5L	20	12L	28	19L	34	26L	42	33L	66		
6H	1	13H	49	20H	37	27H	47	34H	31		
6L	2	13L	50	20L	38	27L	48	34L	32		
7H	5	14H	35	21H	43	28H	51	35H	71		
7L	6	14L	36	21L	44	28L	52	35L	72		

WARNING

As a safety feature, interlock 1 pins (39 and 59) on Bank 1 must be shorted to enable the Bank 1 Analog Bus relays to close. The optional 34924T terminal blocks short these pins for you. This feature protects inadvertent routing of high voltages from the Analog Buses to the D-sub connector of the module.

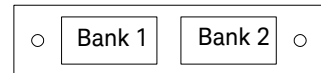

For orientation, the D-sub connector end of the module is facing you.

Bank 2

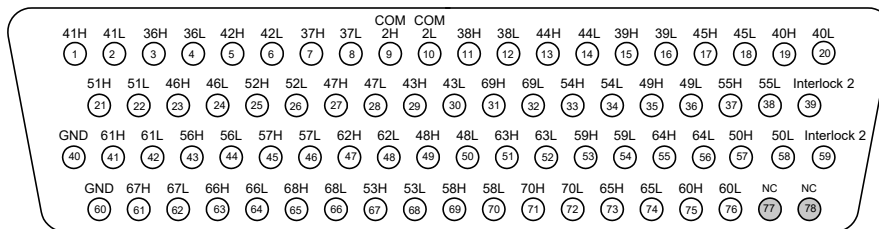

78-Pin D-Sub Male Connector

Description	Pin	Description	Pin	Description	Pin	Description	Pin	Description	Pin	Description	Pin
36H	3	43H	29	50H	57	57H	45	64H	55	COM2 H	9
36L	4	43L	30	50L	58	57L	46	64L	56	COM2 L	10
37H	7	44H	13	51H	21	58H	69	65H	73	Interlock 2	39
37L	8	44L	14	51L	22	58L	70	65L	74	Interlock 2	59
38H	11	45H	17	52H	25	59H	53	66H	63	GND	40
38L	12	45L	18	52L	26	59L	54	66L	64	GND	60
39H	15	46H	23	53H	67	60H	75	67H	61	No Connect	77
39L	16	46L	24	53L	68	60L	76	67L	62	No Connect	78
40H	19	47H	27	54H	33	61H	41	68H	65		
40L	20	47L	28	54L	34	61L	42	68L	66		

Description	Pin	Description	Pin	Description	Pin	Description	Pin	Description	Pin	Description	Pin
41H	1	48H	49	55H	37	62H	47	69H	31		
41L	2	48L	50	55L	38	62L	48	69L	32		
42H	5	49H	35	56H	43	63H	51	70H	71		
42L	6	49L	36	56L	44	63L	52	70L	72		

WARNING

As a safety feature, interlock 2 pins (39 and 59) on Bank 2 must be shorted to enable the Bank 2 Analog Bus relays to close. The optional 34924T terminal blocks short these pins for you. This feature protects inadvertent routing of high voltages from the Analog Buses to the D-sub connector of the module.

34924T Terminal Blocks

Two terminal blocks are available to facilitate wiring connections to the 34924A module:

34924T-001 (Option 001)	Terminal block with solder connectors
34924T-002 (Option 002)	Terminal block with screw connectors

NOTE

All modules that connect to the internal DMM are interlock protected. This means that when an installed module is exposed (no terminal block or cable is connected), the Analog Bus relays are open and disconnected from the Analog Buses. See **“Safety Interlock”** on page 19 for further information.

34924T-001 Terminal Block

This terminal block with solder-type connections is labeled with the model number and the abbreviated module name. In addition, space is available on the label for you to write the slot number.

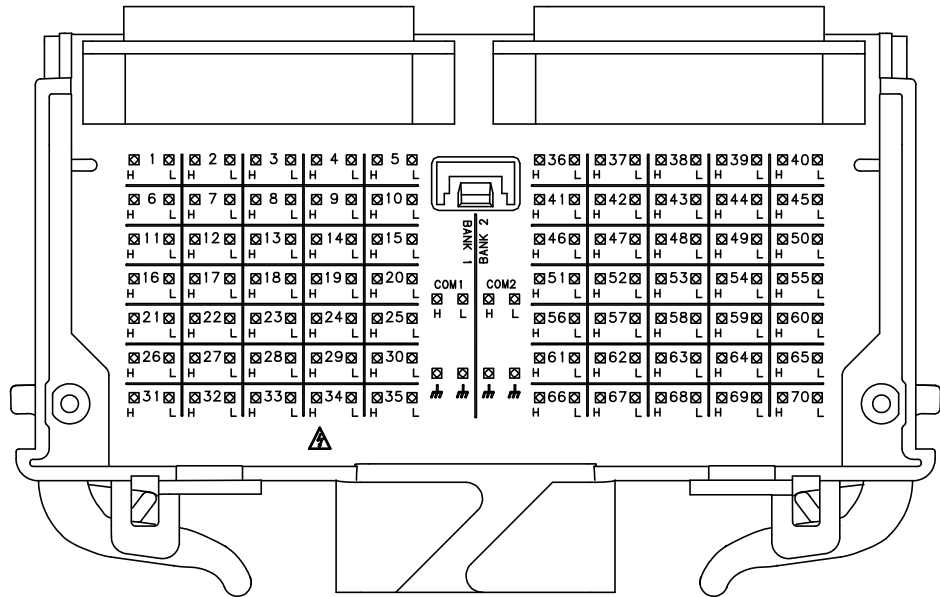

WARNING

Terminal block wiring: Failure to follow the instructions below could result in equipment damage and may result in hazardous conditions such as fire or shock and could lead to personal injury or death.

Wiring of the terminal block must be performed by qualified persons. A **MAXIMUM** of 5 mm of conductor insulation is to be removed. All wire strands must be appropriately inserted in the connector housing. The screw connections must be sufficiently secured to prevent accidental loosening.

Never operate the instrument without the terminal block covers securely installed. Use caution to prevent operators from accessing any external circuits, test fixtures, cables or whenever hazardous voltages may be present.

WARNING**External Wiring for Hazardous Voltages:**

To ensure minimum safety insulation when wiring with hazardous voltages, ensure all wiring (both internal and external to the instruments):

- follow (USA) NFPA 79 Table 12.5.1 Conductor Ampacity and 12.5.5(a) Ambient Temperature Correction Factors (or equivalent National Code requirements) when selecting the AWG required.
 - are rated for at least 2 x the maximum applied voltage of the external source or any interconnecting system modules or external connections.
 - flame rated minimum:
 - Wires and cables with overall cross-sectional area of the conductors exceeding 0.5mm^2 meet test of IEC 60332-1-2 (IEC); or
 - Wires and cables with overall cross-sectional area of the conductors of 0.5mm^2 or less, the test of IEC 60332-2-2 (IEC); or
 - FT-1 of CSA C22.2 No. 0.3 (Canada); or
 - VW-1 of UL 1581 (US).
 - temperature rated for the application.
 - classified and suitable to be used external to the enclosure:
 - AWM Class II B or A/B – external/interconnecting wires (single- or multiple-conductor constructions with a jacket) and potentially subject to mechanical abuse (Canada)
 - AWM Style Use – external interconnection of electronic equipment or appliances (US)
-

34924T-002 Terminal Block

This terminal block with screw-type connections is labeled with the model number and the abbreviated module name. In addition, space is available on the label for you to write the slot number.

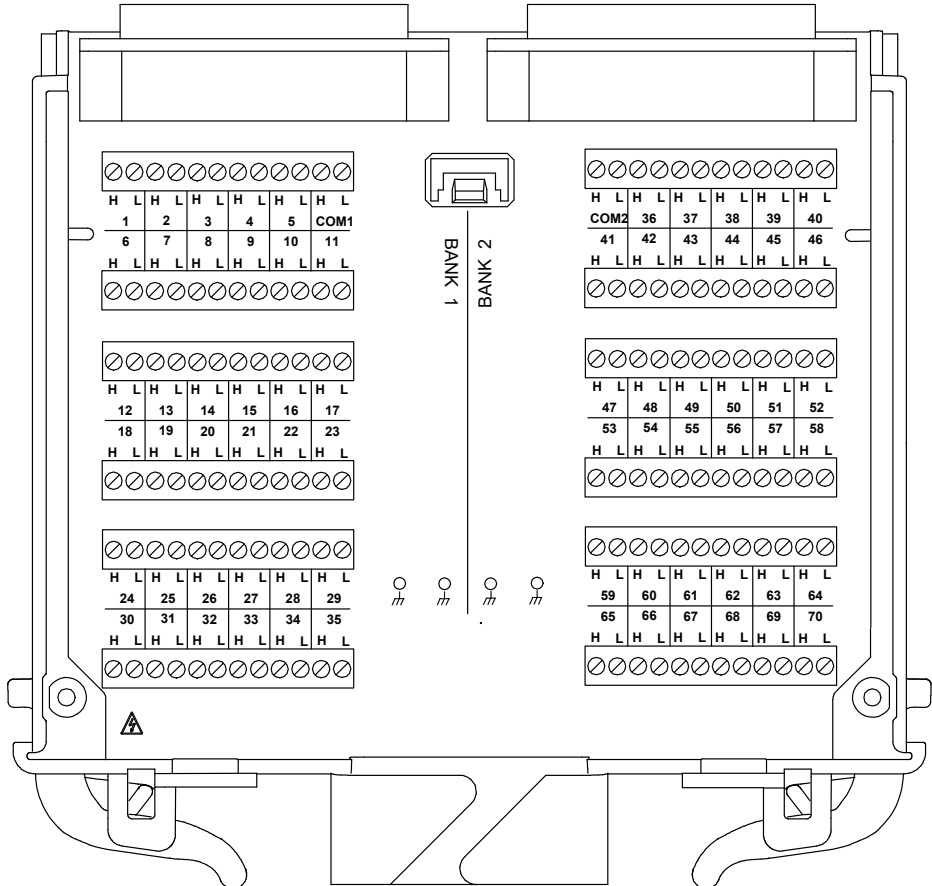

WARNING

Terminal block wiring: Failure to follow the instructions below could result in equipment damage and may result in hazardous conditions such as fire or shock and could lead to personal injury or death.

Wiring of the terminal block must be performed by qualified persons. A **MAXIMUM** of 5 mm of conductor insulation is to be removed. All wire strands must be appropriately inserted in the connector housing. The screw connections must be sufficiently secured to prevent accidental loosening.

Never operate the instrument without the terminal block covers securely installed. Use caution to prevent operators from accessing any external circuits, test fixtures, cables or whenever hazardous voltages may be present.

WARNING**External Wiring for Hazardous Voltages:**

To ensure minimum safety insulation when wiring with hazardous voltages, ensure all wiring (both internal and external to the instruments):

- follow (USA) NFPA 79 Table 12.5.1 Conductor Ampacity and 12.5.5(a) Ambient Temperature Correction Factors (or equivalent National Code requirements) when selecting the AWG required.
 - are rated for at least 2 x the maximum applied voltage of the external source or any interconnecting system modules or external connections.
 - flame rated minimum:
 - Wires and cables with overall cross-sectional area of the conductors exceeding 0.5mm^2 meet test of IEC 60332-1-2 (IEC); or
 - Wires and cables with overall cross-sectional area of the conductors of 0.5mm^2 or less, the test of IEC 60332-2-2 (IEC); or
 - FT-1 of CSA C22.2 No. 0.3 (Canada); or
 - VW-1 of UL 1581 (US).
 - temperature rated for the application.
 - classified and suitable to be used external to the enclosure:
 - AWM Class II B or A/B – external/interconnecting wires (single- or multiple-conductor constructions with a jacket) and potentially subject to mechanical abuse (Canada)
 - AWM Style Use – external interconnection of electronic equipment or appliances (US)
-

34925A 40/80-Channel Optically-Isolated FET Multiplexer

The 34925A 40/80-Channel Optically-Isolated FET Multiplexer (40/80-Ch FET MUX) module is a high-speed and high-density FET MUX for high throughput production test. This module is divided into two equal banks of non-latching FET switches. This module also contains four armature Analog Bus relays. Through ABus1 and ABus2 you can connect any of the channels to the internal DMM for voltage or resistance measurements. When the power is off, all channel and Analog Bus relays open.

Using program commands or the mainframe front panel, you can control each of the FET channel switches individually, and configure this module for differential (2-wire or 4-wire) or single-ended (1-wire) mode. Refer to the simplified schematics on [page 73](#) and [page 80](#).

If you are using an Keysight 34925T-00x terminal block to connect your DUT to this module, be sure to use the terminal block that corresponds to your module configuration mode (Refer to the terminal block drawings on [page 77](#) and [page 83](#)):

34925T-001 (Option 001)	Terminal block for differential (two- or four-wire) mode
34925T-002 (Option 002)	Terminal block for single-ended (1-wire) mode

You can confirm the mode in which your module is configured by using the **SYSTEM:CTYPE? <slot number>** program command. This command returns the identity of the plug-in module in the specified slot.

NOTE

Whenever you change from 2- or 4-wire mode to 1-wire mode, or the reverse, you must cycle power on the 34980A for the configuration to take effect.

Two-Wire Mode

- two independent 20-channel 2-wire MUXes. This configuration requires neither using external wiring nor connecting through the internal Analog Bus relays.

- one 40-channel, 2-wire MUX. You must use external wiring or connect through the Analog Bus relays to for this configuration.

Four-Wire Mode

- You may configure the 34925A as a single 20-channel 4-wire MUX. This configuration requires using neither external wiring nor connecting through the internal Analog Buses. For 4-wire resistance measurements, the instrument automatically pairs channel n on Bank 1 (source) with channel $n+20$ on Bank 2 (sense) to provide these connections. Four-wire controls occur only when doing 4-wire measurement operations through the internal DMM, such as **MEASure:FRESistance?** or scanning a channel previously configured as 4-wire.

One-Wire Mode

- two independent 40-channel 1-wire MUXes. This configuration requires neither using external wiring nor connecting through the Analog Bus relays.
- one 80-channel 1-wire MUX. You must use external wiring or connect through the Analog Bus relays for this configuration.

NOTE

Because all bank relays supply only HI signals, you can apply a LOW signal through COM1 L or COM2 L when you are making 2-wire resistance measurements in 1-wire mode.

Interlock Protection

This module is interlock protected, which means whenever the D-sub connector end of the modules is exposed, the Analog Bus relays immediately open and disconnect from the Analog Buses. For more information, see [“Safety Interlock”](#) on page 19.

Overvoltage Protection

This module also features high voltage detection (< 100 V) and current limiting circuitry to protect the FET relays. This circuitry senses current flows from input overvoltages. These overvoltages may come from either the MUX input or from the Analog Buses. In addition, each channel is also protected from input overvoltages with a resistor.

When overvoltage is detected, all relays (Analog Bus and FET) are opened. While in the overvoltage state, any attempts to close any Analog Bus or FET switch, results in an error status response from the module.

Once in the overvoltage state, you must restore normal module operation with one of these actions:

- using the **SYSTEM:CPON <slot>** command. This affects only the module specified.
- using the ***RST** command. This command resets the mainframe and all installed modules to the Factory configuration. This affects all installed modules.
- cycling system power. This affects all installed modules.

If the overvoltage situation is not resolved, clearing the overvoltage will result in a new overvoltage event occurring immediately.

Further FET protection is assured only as one channel in each bank is closed at any time. Thus this module will operate as only a 1:N MUX module. For more information about FET channel closures, refer to [page 21](#).

34925A Simplified Schematic for Two- or Four-Wire Mode

This drawing shows two independent 20-channel 2-wire MUXes. To change configuration modes, use the `SYSTEM:MODULE:WIRE:MODE` command.

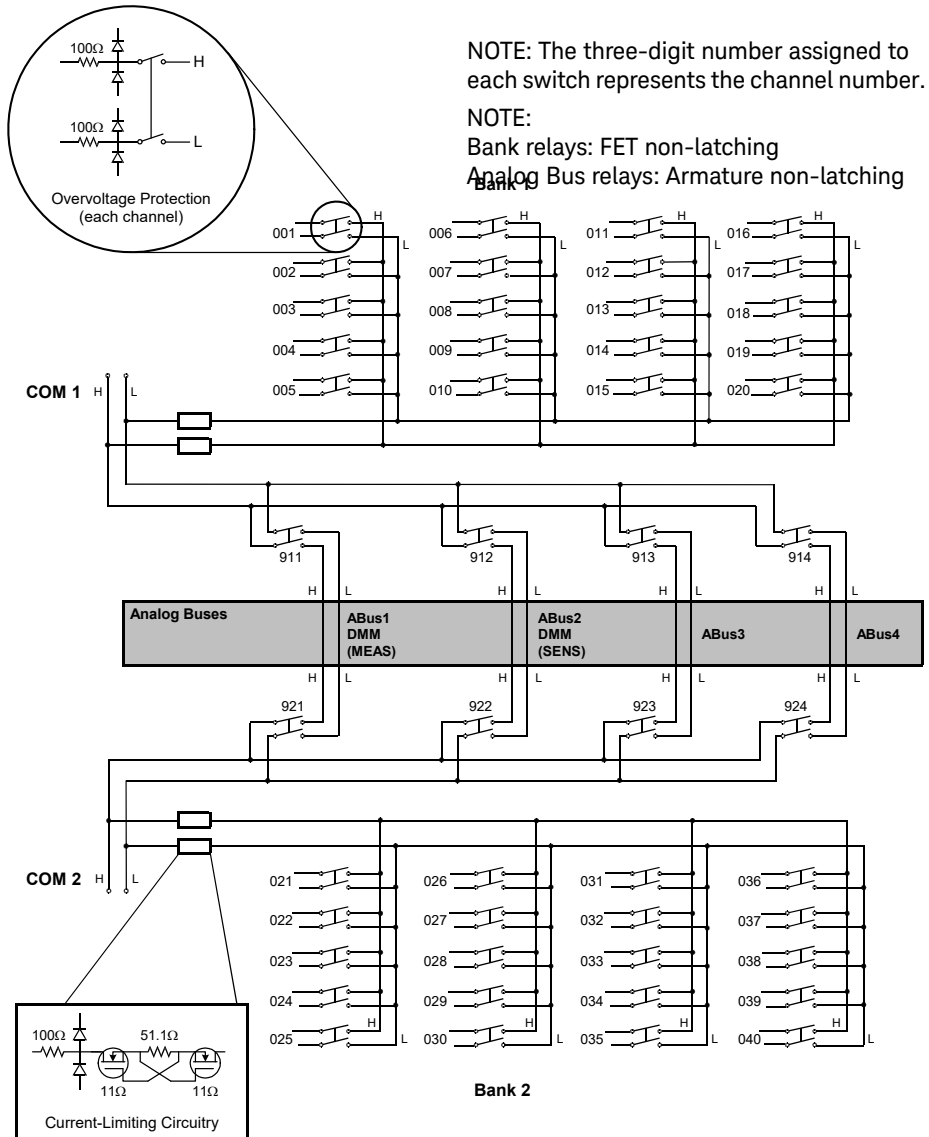

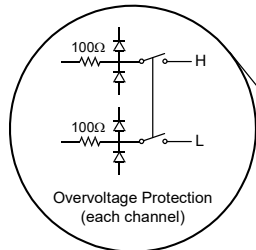

NOTE: The three-digit number assigned to each switch represents the channel number.

NOTE:

Bank relays: FET non-latching

Analog Bus relays: Armature non-latching

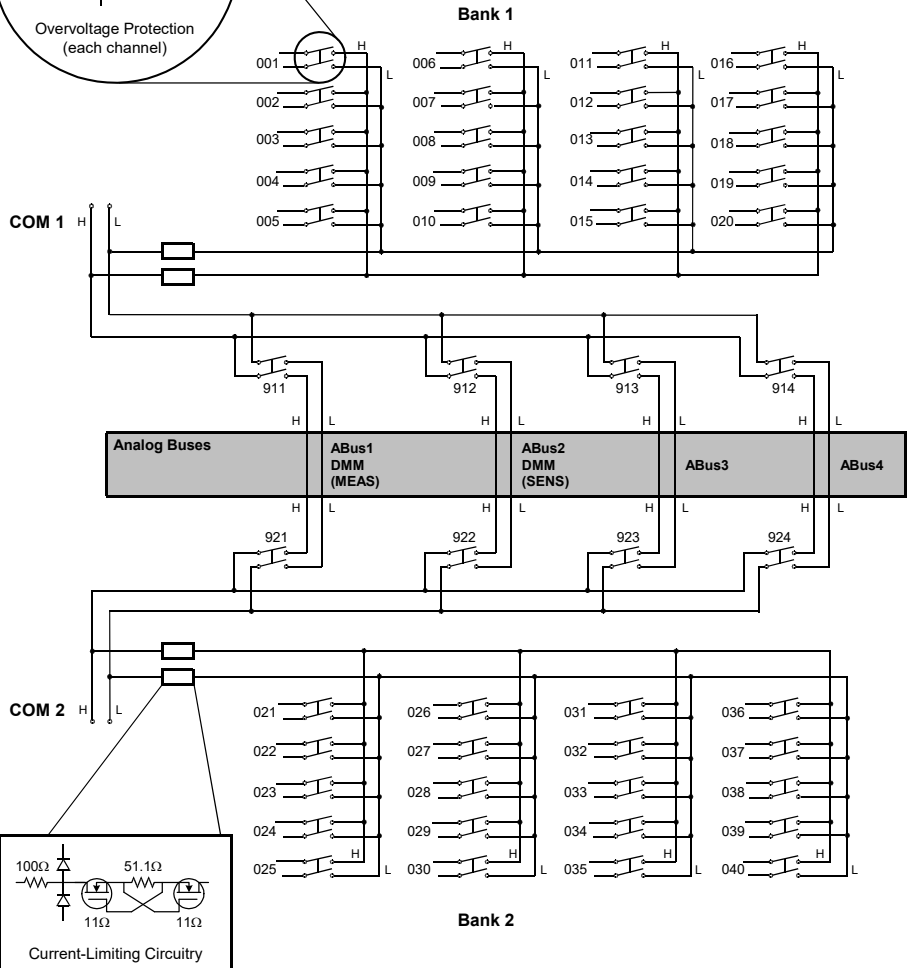

34925A D-Sub Connectors for Two- or Four-Wire Mode

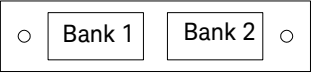

For orientation, the D-sub connector end of the module is facing you.

Bank 1

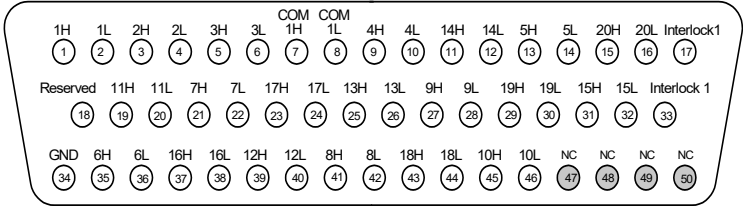

50-Pin D-Sub Male Connector

Description	Pin	Description	Pin	Description	Pin	Description	Pin	Description	Pin
1H	1	6H	35	11H	19	16H	37	COM1 H	7
1L	2	6L	36	11L	20	16L	38	COM1 L	8
2H	3	7H	21	12H	39	17H	23	Interlock 1	17
2L	4	7L	22	12L	40	17L	24	Interlock 1	33
3H	5	8H	41	13H	25	18H	43	Reserved	18
3L	6	8L	42	13L	26	18L	44	GND	34
4H	9	9H	27	14H	11	19H	29	No Connect	47
4L	10	9L	28	14L	12	19L	30	No Connect	48
5H	13	10H	45	15H	31	20H	15	No Connect	49
5L	14	10L	46	15L	32	20L	16	No Connect	50

WARNING

As a safety feature, interlock 1 pins (17 and 33) on Bank 1 must be shorted to enable the Bank 1 Analog Bus relays to close. The optional 34925T-001 (for 2-wire) terminal block shorts these pins for you. This feature protects inadvertent routing of high voltages from the Analog Bus to the D-sub connector of the module.

Bank 2

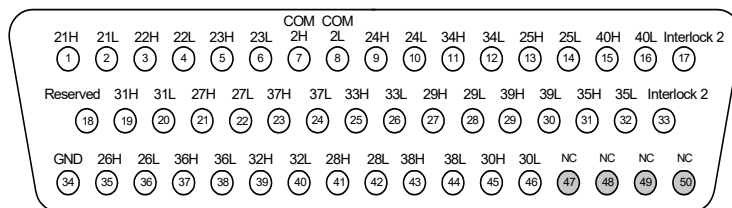

50-Pin D-Sub
Male Connector

Description	Pin	Description	Pin	Description	Pin	Description	Pin	Description	Pin
21H	1	26H	35	31H	19	36H	37	COM2 H	7
21L	2	26L	36	31L	20	36L	38	COM2 L	8
22H	3	27H	21	32H	39	37H	23	Interlock 2	17
22L	4	27L	22	32L	40	37L	24	Interlock 2	33
23H	5	28H	41	33H	25	38H	43	Reserved	18
23L	6	28L	42	33L	26	38L	44	GND	34
24H	9	29H	27	34H	11	39H	29	No Connect	47
24L	10	29L	28	34L	12	39L	30	No Connect	48
25H	13	30H	45	35H	31	40H	15	No Connect	49
25L	14	30L	46	35L	32	40L	16	No Connect	50

WARNING

As a safety feature, interlock 2 pins (17 and 33) on Bank 2 must be shorted to enable the Bank 2 Analog Bus relays to close. The optional 34925T-001 (for 2-wire) terminal block shorts these pins for you. This feature protects inadvertent routing of high voltages from the Analog Buses to the D-sub connector of the module.

34925T-001 Terminal Block for Two-Wire or Four-Wire Mode

This terminal block with screw-type connections is labeled with the model number and the abbreviated module name. In addition, space is available on the label for you to write the slot number.

NOTE

All modules that connect to the internal DMM are interlock protected. This means that when an installed module is exposed (no terminal block or cable is connected), the Analog Bus relays are open and disconnected from the Analog Buses. See “**Safety Interlock**” on page 19 for further information.

NOTE

If you are using an Keysight terminal block to connect your DUT to this module be sure to use the 34925T-001 terminal block that corresponds to the 2- or 4-wire configuration mode. An error will not be generated if you have installed a terminal block that doesn't match the present module configuration.

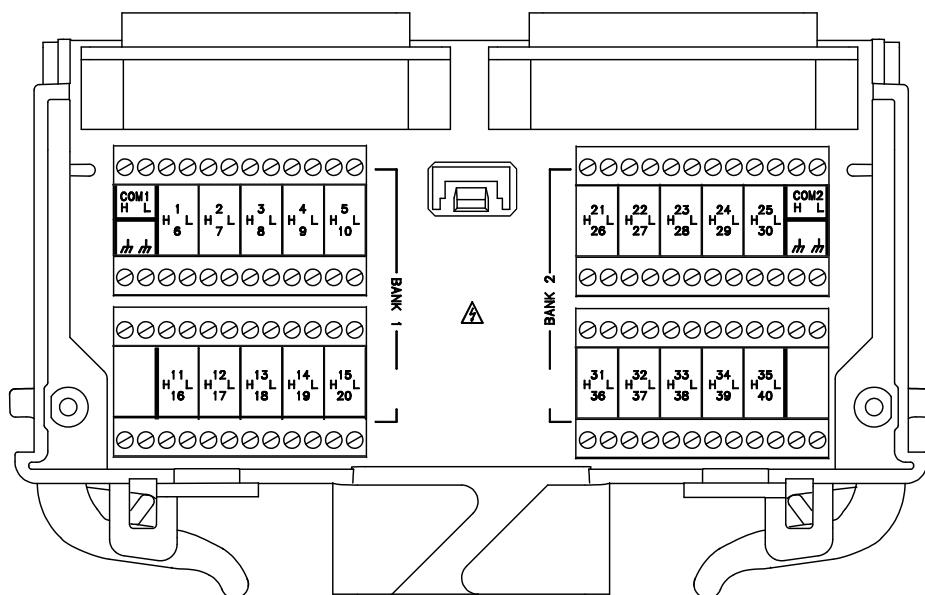

WARNING

Terminal block wiring: Failure to follow the instructions below could result in equipment damage and may result in hazardous conditions such as fire or shock and could lead to personal injury or death.

Wiring of the terminal block must be performed by qualified persons. A **MAXIMUM** of 5 mm of conductor insulation is to be removed. All wire strands must be appropriately inserted in the connector housing. The screw connections must be sufficiently secured to prevent accidental loosening.

Never operate the instrument without the terminal block covers securely installed. Use caution to prevent operators from accessing any external circuits, test fixtures, cables or whenever hazardous voltages may be present.

WARNING**External Wiring for Hazardous Voltages:**

To ensure minimum safety insulation when wiring with hazardous voltages, ensure all wiring (both internal and external to the instruments):

- follow (USA) NFPA 79 Table 12.5.1 Conductor Ampacity and 12.5.5(a) Ambient Temperature Correction Factors (or equivalent National Code requirements) when selecting the AWG required.
 - are rated for at least 2 x the maximum applied voltage of the external source or any interconnecting system modules or external connections.
 - flame rated minimum:
 - Wires and cables with overall cross-sectional area of the conductors exceeding 0.5mm^2 meet test of IEC 60332-1-2 (IEC); or
 - Wires and cables with overall cross-sectional area of the conductors of 0.5mm^2 or less, the test of IEC 60332-2-2 (IEC); or
 - FT-1 of CSA C22.2 No. 0.3 (Canada); or
 - VW-1 of UL 1581 (US).
 - temperature rated for the application.
 - classified and suitable to be used external to the enclosure:
 - AWM Class II B or A/B – external/interconnecting wires (single- or multiple-conductor constructions with a jacket) and potentially subject to mechanical abuse (Canada)
 - AWM Style Use – external interconnection of electronic equipment or appliances (US)
-

34925A Simplified Schematic for One-Wire Mode

This drawing shows two independent 40-channel, 1-wire MUXes.

To change configuration modes, use the **SYSTEM:MODULE:WIRE:MODE** command.

NOTE: The three-digit number assigned to each switch represents the channel number.

NOTE: Bank relays: FET non-latching
Analog Bus relays: Armature non-latching

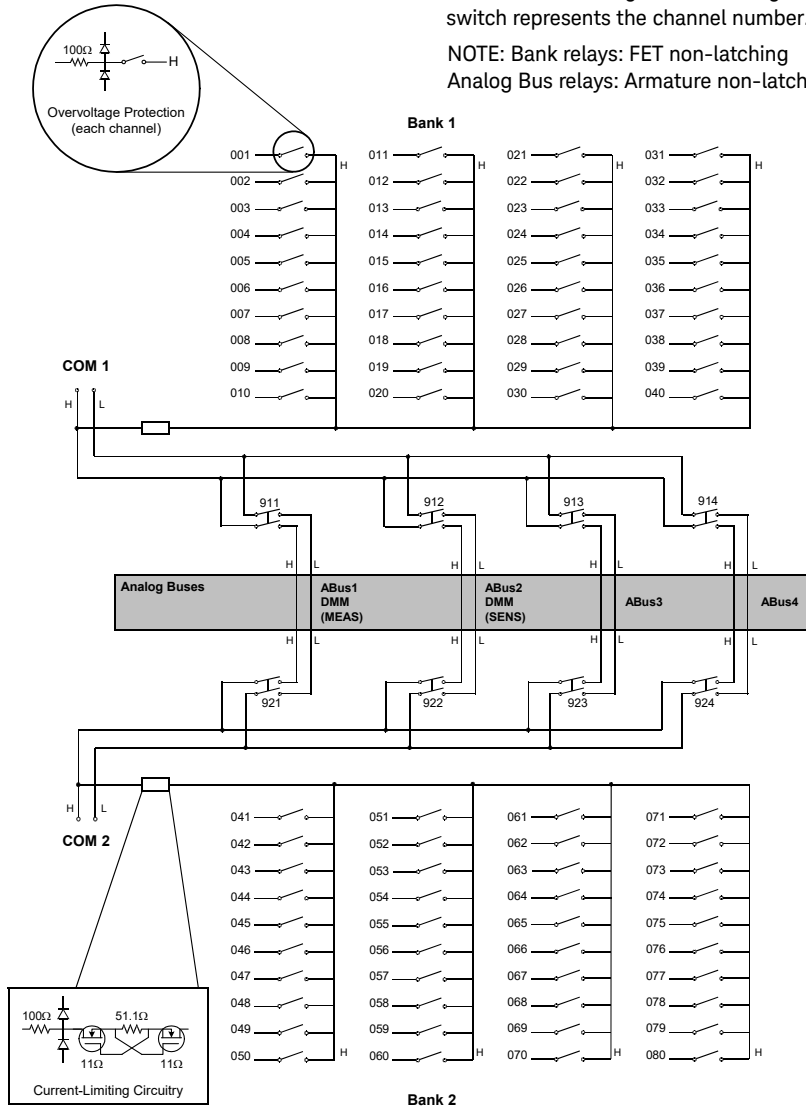

34925A D-Sub Connectors for One-Wired Mode

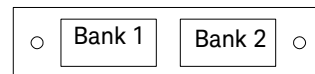

For orientation, the D-sub connector end of the module is facing you.

Bank 1

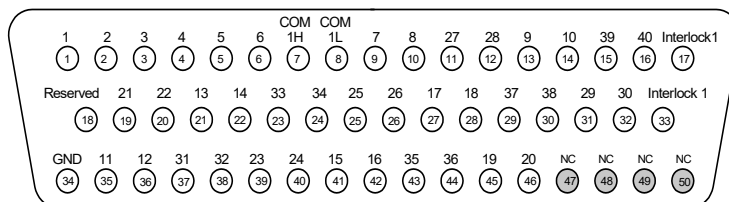

50-Pin D-Sub Male Connector

Description	Pin	Description	Pin	Description	Pin	Description	Pin	Description	Pin
1	1	11	35	21	19	31	37	COM1 H	7
2	2	12	36	22	20	32	38	COM1 L	8
3	3	13	21	23	39	33	23	Interlock 1	17
4	4	14	22	24	40	34	24	Interlock 1	33
5	5	15	41	25	25	35	43	Reserved	18
6	6	16	42	26	26	36	44	GND	34
7	9	17	27	27	11	37	29	No Connect	47
8	10	18	28	28	12	38	30	No Connect	48
9	13	19	45	29	31	39	15	No Connect	49
10	14	20	46	30	32	40	16	No Connect	50

WARNING

As a safety feature, interlock 1 pins (17 and 33) on Bank 1 must be shorted to enable the Bank 1 Analog Bus relays to close. The optional 34925T-002 (for 1-wire) terminal block shorts these pins for you. This feature protects inadvertent routing of high voltages from the Analog Bus to the D-sub connector of the module.

Bank 2

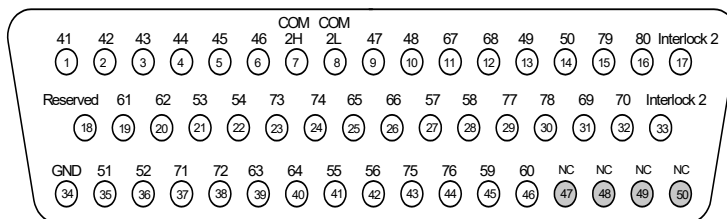

50-Pin D-Sub
Male Connector

Description	Pin	Description	Pin	Description	Pin	Description	Pin	Description	Pin
41	1	51	35	61	19	71	37	COM2 H	7
42	2	52	36	62	20	72	38	COM2 L	8
43	3	53	21	63	39	73	23	Interlock 2	17
44	4	54	22	64	40	74	24	Interlock 2	33
45	5	55	41	65	25	75	43	Reserved	18
46	6	56	42	66	26	76	44	GND	34
47	9	57	27	67	11	77	29	No Connect	47
48	10	58	28	68	12	78	30	No Connect	48
49	13	59	45	69	31	79	15	No Connect	49
50	14	60	46	70	32	80	16	No Connect	50

WARNING

As a safety feature, interlock 2 pins (17 and 33) on Bank 2 must be shorted to enable the Bank 2 Analog Bus relays to close. The optional 34925T-002 (for 1-wire) terminal block shorts these pins for you. This feature protects inadvertent routing of high voltages from the Analog Buses to the D-sub connector of the module.

34925T-002 Terminal Block for One-Wire Mode

This terminal block with screw-type connections is labeled with the model number and the abbreviated module name. In addition, space is available on the label for you to write the slot number.

NOTE

All modules that connect to the internal DMM are interlock protected. This means that when an installed module is exposed (no terminal block or cable is connected), the Analog Bus relays are open and disconnected from the Analog Buses. See **“Safety Interlock”** on page 19 for further information.

NOTE

If you are using an Keysight terminal block to connect your DUT to this module be sure to use the 34925T-002 terminal block that corresponds to the 1-wire configuration mode. An error will not be generated if you have installed a terminal block that doesn't match the present module configuration.

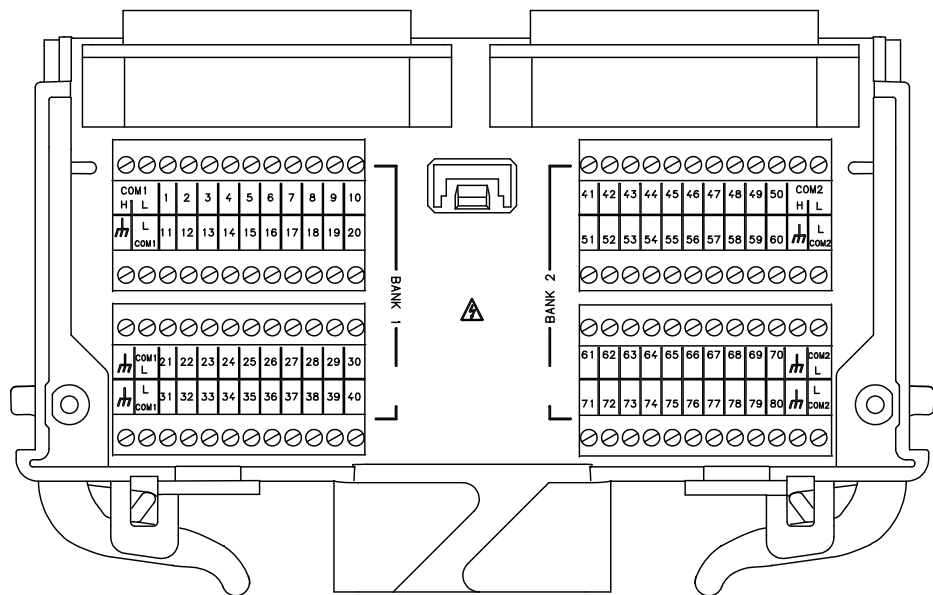

WARNING

Terminal block wiring: Failure to follow the instructions below could result in equipment damage and may result in hazardous conditions such as fire or shock and could lead to personal injury or death.

Wiring of the terminal block must be performed by qualified persons. A **MAXIMUM** of 5 mm of conductor insulation is to be removed. All wire strands must be appropriately inserted in the connector housing. The screw connections must be sufficiently secured to prevent accidental loosening.

Never operate the instrument without the terminal block covers securely installed. Use caution to prevent operators from accessing any external circuits, test fixtures, cables or whenever hazardous voltages may be present.

WARNING**External Wiring for Hazardous Voltages:**

To ensure minimum safety insulation when wiring with hazardous voltages, ensure all wiring (both internal and external to the instruments):

- follow (USA) NFPA 79 Table 12.5.1 Conductor Ampacity and 12.5.5(a) Ambient Temperature Correction Factors (or equivalent National Code requirements) when selecting the AWG required.
 - are rated for at least 2 x the maximum applied voltage of the external source or any interconnecting system modules or external connections.
 - flame rated minimum:
 - Wires and cables with overall cross-sectional area of the conductors exceeding 0.5mm^2 meet test of IEC 60332-1-2 (IEC); or
 - Wires and cables with overall cross-sectional area of the conductors of 0.5mm^2 or less, the test of IEC 60332-2-2 (IEC); or
 - FT-1 of CSA C22.2 No. 0.3 (Canada); or
 - VW-1 of UL 1581 (US).
 - temperature rated for the application.
 - classified and suitable to be used external to the enclosure:
 - AWM Class II B or A/B – external/interconnecting wires (single- or multiple-conductor constructions with a jacket) and potentially subject to mechanical abuse (Canada)
 - AWM Style Use – external interconnection of electronic equipment or appliances (US)
-

34980A Current Limiting Graphs

Modules	Pollution Degree 1	Pollution Degree 2	Transients
Analog Bus 34980A Multiplexer 34921A Terminal Block 34921T	40 channels, 45 MHz ±300 Vrms or VDC ¹ 1A (switch) / 2A (carry) 60VA per channel ² Volt-Hertz limit: 10 ⁸ Initial closed channel resistance: <1.5 Ω ^{3,4}	40 channels, 45MHz ±100 Vrms or VDC ¹ 1A (switch) / 2A (carry) 60VA per channel ² Volt-Hertz limit: 10 ⁸ Initial closed channel resistance: <1.5 Ω ^{3,4}	1000Vpk
Multiplexer 34922A Terminal Block 34922T	70 channels, 25MHz ±300 Vrms or VDC ¹ 1A (switch) / 2A (carry) 60VA per channel ² Volt-Hertz limit: 10 ⁸ Initial closed channel resistance: <1.5 Ω ^{3,4}	70 channels, 25MHz ±100 Vrms or VDC ¹ 1A (switch) / 2A (carry) 60VA per channel ² Volt-Hertz limit: 10 ⁸ Initial closed channel resistance: <1.5 Ω ^{3,4}	1000Vpk

The overcurrent protection devices will be rated, or the snubber circuits will limit the current, according to:

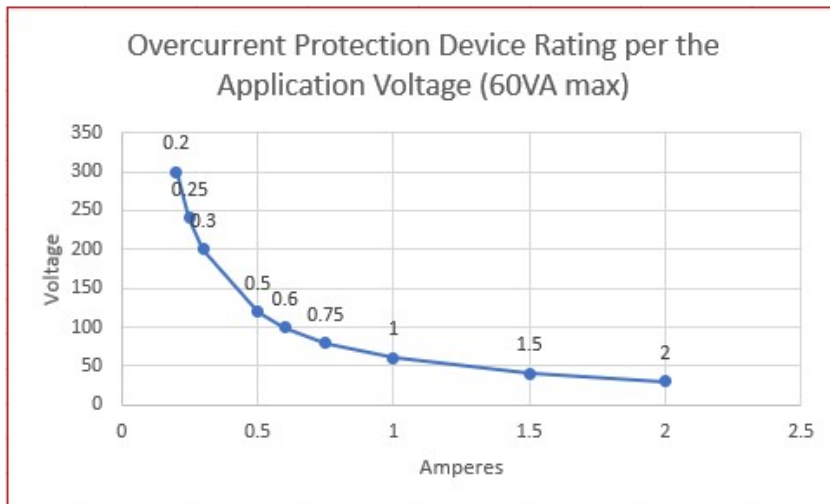

1. DC or AC RMS voltage, channel-to-channel or channel-to-earth.
 2. Limited to 6 W of channel resistance power loss per module.
 3. Into analog bus. System errors are included in the internal DMM measurement accuracy specifications.
 4. Channel resistance is typically $< 1.5 \Omega$ but can go as high as 50Ω when a channel is used in measurement applications with $< 10 \text{ mA}$ load current. Increased relay channel resistance for measurements with load currents below 10 mA can occur on cards that have been out of service or following relay inactivity for periods of greater than 1 week. Switching relays for 2K cycles prior to use may reduce the variation in channel resistance. Keysight recommends the use of 4-wire Ohms for resistance measurements. For high accuracy voltage measurements, select the DMM input resistance setting of $> 10 \text{ G ohms}$ to minimize the impact of relay contact resistance.
-

Modules	Pollution Degree 1	Pollution Degree 2	Transients
Multiplexer 34923A Terminal Block 34923T	40/80 channels, 45MHz	40/80 channels, 45MHz	750Vpk
	$\pm 150\text{Vpeak}^1$	$\pm 100\text{Vpeak}^1$	
	$0.5\text{A}^2 / 0.05\text{A}^3$ (switch)	$0.5\text{A}^2 / 0.05\text{A}^3$ (switch)	
	$1.5\text{A}^2 / 0.05\text{A}^3$ (carry)	$1.5\text{A}^2 / 0.05\text{A}^3$ (carry)	
	10VA per channel ⁵	10VA per channel ⁵	
	Volt-Hertz limit: 10^8	Volt-Hertz limit: 10^8	
	Initial closed channel resistance ^{2,6,7} : <1.5 Ω / 200 Ω	Initial closed channel resistance ^{2,6,7} : <1.5 Ω / 200 Ω	
Multiplexer 34924A Terminal Block 34924T	35/70 channels, 25MHz	35/70 channels, 25MHz	750Vpk
	$\pm 150\text{Vpeak}^1$	$\pm 100\text{Vpeak}^1$	
	$0.5\text{A}^2 / 0.05\text{A}^3$ (switch)	$0.5\text{A}^2 / 0.05\text{A}^3$ (switch)	
	$1.5\text{A}^2 / 0.05\text{A}^3$ (carry)	$1.5\text{A}^2 / 0.05\text{A}^3$ (carry)	
	10VA per channel ⁵	10VA per channel ⁵	
	Volt-Hertz limit: 10^8	Volt-Hertz limit: 10^8	
	Initial closed channel resistance ^{2,6,7} : <1.5 Ω / 200 Ω	Initial closed channel resistance ^{2,6,7} : <1.5 Ω / 200 Ω	

The overcurrent protection devices will be rated, or the snubber circuits will limit the current, according to:

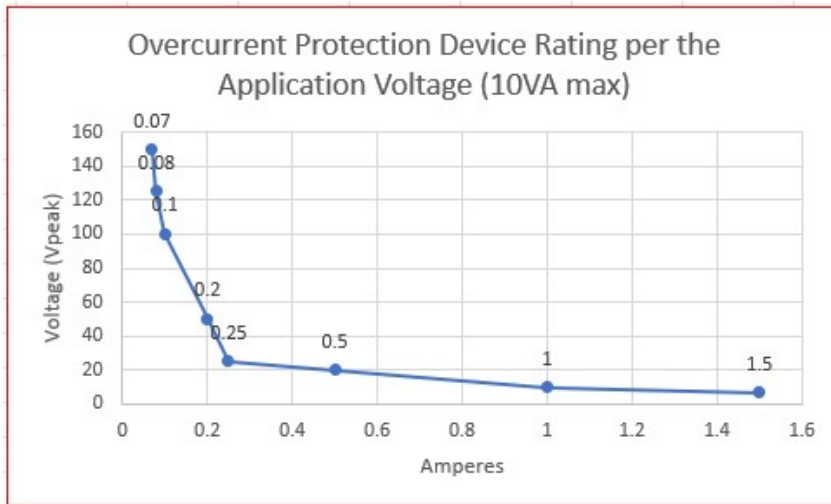

1. Peak voltage, channel-to-channel or channel-to-earth.
 2. With input resistors bypassed. Bypassing resistors will reduce the lifetime of relays. See the rated load relay life characteristics.
 3. With input protection resistors: $2 \times 100 \Omega \pm 5\%$; 0.5W; TC = ± 200 ppm/ $^{\circ}$ C. The series resistance of the 34923/24 limits the use of the 100Ω range.
 5. Limited to 6 W of channel resistance power loss per module.
 6. Into analog bus. System errors are included in the internal DMM measurement accuracy specifications.
 7. Channel resistance is typically $< 1.5 \Omega$ but can go as high as 50Ω when a channel is used in measurement applications with < 10 mA load current. Increased relay channel resistance for measurements with load currents below 10 mA can occur on cards that have been out of service or following relay inactivity for periods of greater than 1 week. Switching relays for 2K cycles prior to use may reduce the variation in channel resistance. Keysight recommends the use of 4-wire Ohms for resistance measurements. For high accuracy voltage measurements, select the DMM input resistance setting of > 10 G ohms to minimize the impact of relay contact resistance.
-

Modules	Pollution Degree 1	Pollution Degree 2	Transients
Multiplexer 34925A	40/80 channels, 1MHz	40/80 channels, 1MHz	1000Vpk
Terminal Block 34925T	±80Vpeak ¹ 0.02A ² 1.6VA/channel ³ Volt-Hertz limit: 10 ⁷ Initial closed channel resistance ^{4,5,6} : <700 Ω	±80Vpeak ¹ 0.02A ² 1.6VA/channel ³ Volt-Hertz limit: 10 ⁷ Initial closed channel resistance ^{4,5,6} : <700 Ω	

The overcurrent protection devices will be rated, or the snubber circuits will limit the current, according to:

Overcurrent Protection Device Rating per Application Voltage (1.6VA max) = 0.02A

1. Peak voltage, channel-to-channel or channel-to-earth.
2. DC or peak AC current.
3. Limited to 6 W of channel resistance power loss per module.
4. With input protection resistors: 2 x 100 Ω ±5%; 0.5W; TC = ±200 ppm/°C. The series resistance of the 34925A limits the use of the 100 Ω range.
5. Into analog bus. System errors are included in the internal DMM measurement accuracy specifications.
6. Channel resistance is typically < 1.5 Ω but can go as high as 50 Ω when a channel is used in measurement applications with < 10 mA load current. Increased relay channel resistance for measurements with load currents below 10 mA can occur on cards that have been out of service or following relay inactivity for periods of greater than 1 week. Switching relays for 2K cycles prior to use may reduce the variation in channel resistance. Applies to the 34921A and 34922A. Keysight recommends the use of 4-wire Ohms for resistance measurements. For high accuracy voltage measurements, select the DMM input resistance setting of >10 G ohms to minimize the impact of relay contact resistance.

Index

Numerics

34921A

- connector pinouts, 28
- description, 25
- external reference, 30
- programming examples, 21
- simplified schematic, 27
- temperature sensor, 30
- terminal block, 30
- valid measurement
- functions, 18
- wiring log, 30

34922A

- connector pinouts, 36
- description, 34
- programming examples, 21
- simplified schematic, 35
- terminal blocks, 38, 41
- valid measurement
- functions, 18
- wiring log, 38

34923A

- connector pinouts, 48, 54
- description, 44
- programming examples, 21
- simplified schematic, 47, 53
- terminal blocks, 50, 56
- valid measurement
- functions, 18
- wiring log, 50, 56

34924A

- connector pinouts, 62
- description, 59
- programming examples, 21
- simplified schematic, 61
- terminal blocks, 64, 67
- valid measurement
- functions, 18
- wiring log, 64

34925A

- connector pinouts, 74, 81
- description, 70
- overload protection, 72

- programming examples, 21
- simplified schematic, 73, 80
- terminal blocks, 77, 83
- valid measurement
- functions, 18
- wiring log, 77, 83

C

connector pinouts

- 34921A, 28
- 34922A, 36
- 34923A, 48, 54
- 34924A, 62
- 34925A, 74, 81

D

D-sub pinouts

- 34921A, 28
- 34922A, 36
- 34923A, 48, 54
- 34924A, 62
- 34925A, 74, 81

E

- external reference, 30

F

- FET protection, 72

I

- isothermal block, 30

O

- operating considerations, 19
- overload protection, 72
- overvoltage protection, 72

P

pinouts

- 34921A, 28
- 34922A, 36
- 34923A, 48, 54
- 34924A, 62
- 34925A, 74, 81

S

- safety notices, 4

T

temperature sensor, 30

terminal block

- 34922T Option 001, 39
- 34922T Option 002, 41
- 34923T Option 001, 50
- 34923T Option 002, 56
- 34924T Option 001, 65
- 34924T Option 002, 67
- 34925T Option 001, 77
- 34925T Option 002, 83

THIS PAGE HAS BEEN INTENTIONALLY LEFT BLANK.



This information is subject to change without notice. Always refer to the Keysight website for the latest revision.

© Keysight Technologies 2008-2022
Edition 5, Aug 2022

Printed in Malaysia



34980-90021

www.keysight.com