

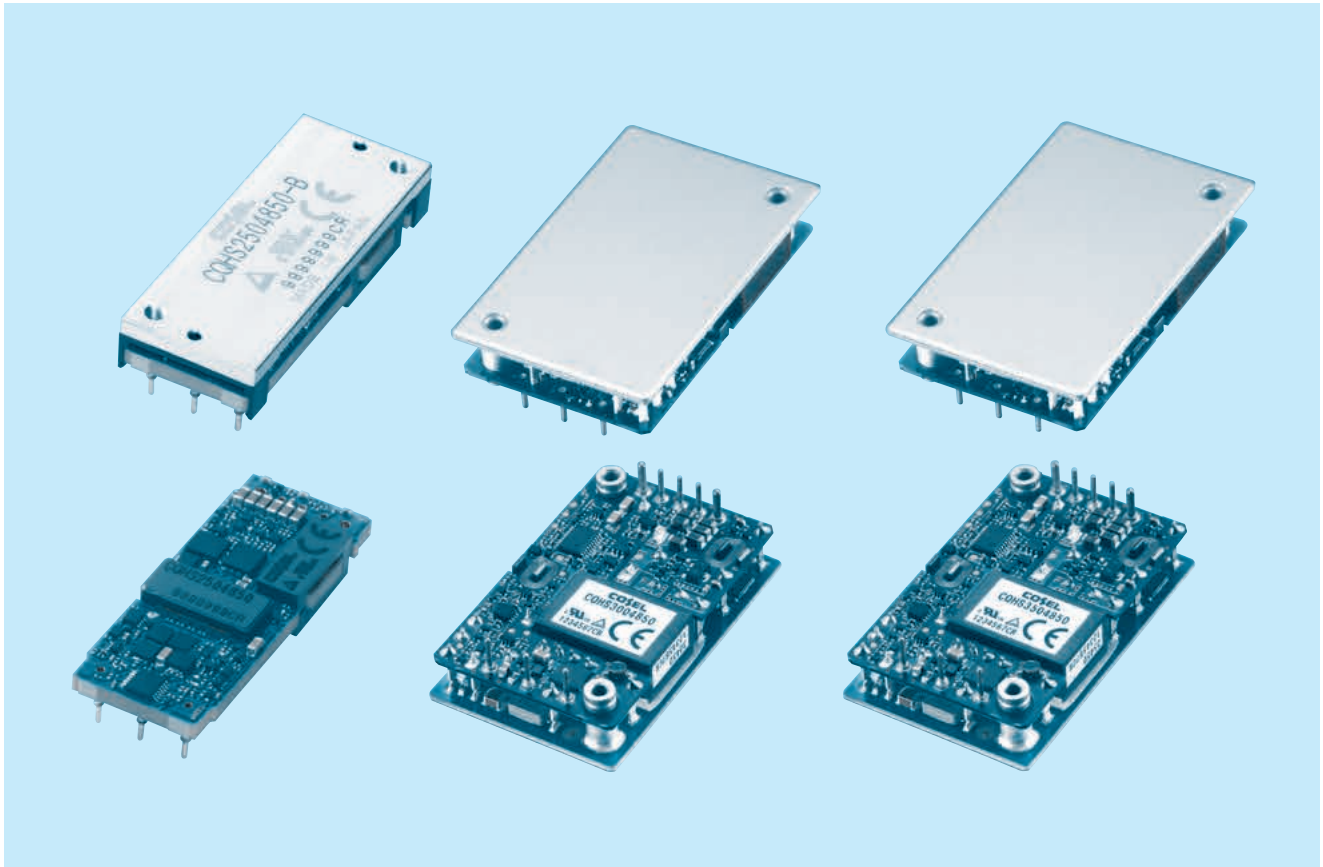

# CQHS-series



## ■ Feature

Compact DC-DC Converter, "BRICK SIZE" which has been standard size for Telecommunication Market  
 High efficiency (synchronous rectifier circuit)  
 High density  
 High reliability : not built-in aluminum and tantalum electrolytic capacitor  
 Built-in overcurrent, overvoltage and thermal protection circuits  
 Built-in remote ON/OFF  
 Mounting hole (M3 tapped)

## ■ CE marking

Low Voltage Directive  
 RoHS Directive

## ■ UKCA marking

Electrical Equipment Safety Regulations  
 RoHS Regulations

## ■ Safety agency approvals

UL60950-1, C-UL, EN62368-1

## ■ 5-year warranty

## ■ Optional parts

Heat sink (optional parts : CQHS300/CQHS350)

# CQHS250

CQH S 250 48 50 -□

① ② ③ ④ ⑤ ⑥

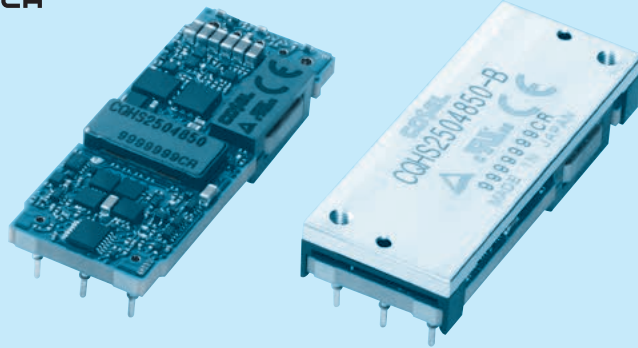
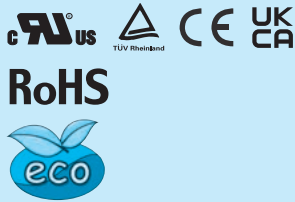

- ① Series name
- ② Single output
- ③ Output wattage
- ④ Input voltage  
48:DC36 - 76V
- ⑤ Output voltage
- ⑥ Optional
- R :with Remote ON/OFF  
Positive logic control
- N :Auto restart in protection  
circuit working
- B :Base plate option with  
Mounting hole M3
- L2:Pin length 5.3mm

MODEL	CQHS2504832	CQHS2504850
MAX OUTPUT WATTAGE[W]	252.8	250
DC OUTPUT	32V 7.9A	50V 5.0A

## SPECIFICATIONS

	MODEL	CQHS2504832	CQHS2504850	
INPUT	VOLTAGE[V]	DC36 - 76		
	CURRENT[A]	5.60typ	5.54typ	
	EFFICIENCY[%]	94typ	94typ	
	START-UP VOLTAGE[V]	DC32 - 36		
	HYSTERESIS VOLTAGE[V]	DC2 min		
OUTPUT	VOLTAGE[V]	32	50	
	CURRENT[A]	7.9	5.0	
	LINE REGULATION[mV]	64max	100max	
	LOAD REGULATION[mV]	64max	100max	
	RIPPLE[mVp-p]	-20 to +85°C Vin=36-60V *2	255max	400max
		-20 to +85°C Vin=60-76V *2	320max	500max
		-40 to -20°C *2	320max	500max
	RIPPLE NOISE[mVp-p]	-20 to +85°C *2	320max	500max
		-40 to -20°C *2	410max	650max
	TEMPERATURE REGULATION[mV]	-40 to +85°C	640max	1000max
DRIFT[mV]	*3	120max	185max	
START-UP TIME[ms]	200max (DCIN 48V, Io=100%)			
OUTPUT VOLTAGE ADJUSTMENT RANGE[V] *4	Fixed (TRM pin open), adjustable by external resistor			
		26.88 - 35.20	45.0 - 55.0	
OUTPUT VOLTAGE SETTING[V] *1	31.68 - 32.32	49.50 - 50.50		
PROTECTION CIRCUIT AND OTHERS	OVERCURRENT PROTECTION	Works over 105% of rating, low voltage protection (shut down) function is built-in.		
	OVERVOLTAGE PROTECTION[V]	36.80 - 44.80	56.50 - 67.50	
	REMOTE SENSING	Provided		
REMOTE ON/OFF	Provided (Negative Logic L : ON, H :OFF)			
ISOLATION	INPUT-OUTPUT	DC1,500V or AC500V 1minute, Cutoff current = 10mA, DC500V 50MΩ min (20±15°C)		
	INPUT-BASE PLATE	*5 DC1,500V or AC500V 1minute, Cutoff current = 10mA, DC500V 50MΩ min (20±15°C)		
	OUTPUT-BASE PLATE	*5 AC500V 1minute, Cutoff current = 100mA, DC500V 50MΩ min (20±15°C)		
ENVIRONMENT	OPERATING TEMP.,HUMID.AND ALTITUDE	-40 to +85°C, 20 - 95%RH (Non condensing) (Refer to "Derating"), 3,000m (10,000 feet) max		
	STORAGE TEMP.,HUMID.AND ALTITUDE	-40 to +100°C, 20 - 95%RH (Non condensing), 9,000m (30,000 feet) max		
	VIBRATION	10 - 55Hz, 49.0m/s <sup>2</sup> (5G), 3minutes period, 60minutes each along X, Y and Z axis		
	IMPACT	196.1m/s <sup>2</sup> (20G), 11ms, once each along X, Y and Z axis		
SAFETY	AGENCY APPROVALS	UL60950-1, C-UL (CSA60950-1), EN62368-1		
OTHERS	CASE SIZE/WEIGHT	57.9 × 10.5 × 22.76mm [2.28 × 0.41 × 0.9 inches] (W × H × D) / 30g max		
	COOLING METHOD	58.4 × 12.7 × 23.26mm [2.3 × 0.5 × 0.92 inches] (W × H × D) / 45g max *5		
	COOLING METHOD	Convection / Forced air / Conduction		

\*1 At rated input(DC48V), rated load. Ta= 25°C, 2m/s.

\*2 Ripple and ripple noise is measured by using measuring board. Refer to the manual.

\*3 Drift is the change in DC output for an eight hour period after a half-hour warm-up at 25°C, with the input voltage held constant at the rated input/output.

\*4 When the input voltage is in the range of DC36-40V, output voltage is limited. Refer to the manual.

\*5 Base Plate Option.

External view

1. DIP

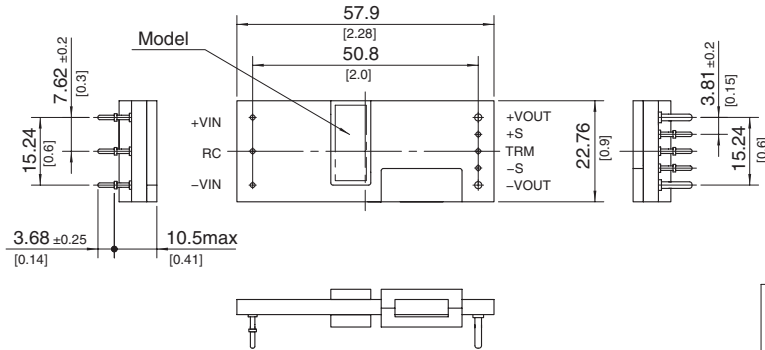

- ※ Tolerance : ±0.5 [±0.02]
- ※ Weight : 30g max(DIP)  
45g max(Base Plate)
- ※ Dimensions in mm, [ ]=inches

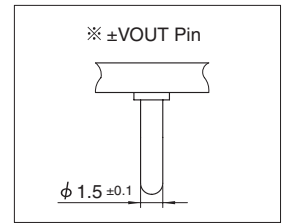
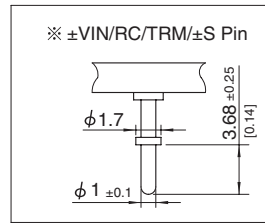

2. Base Plate (option B)

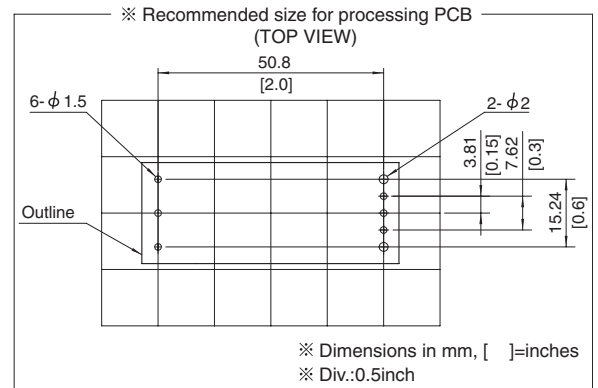
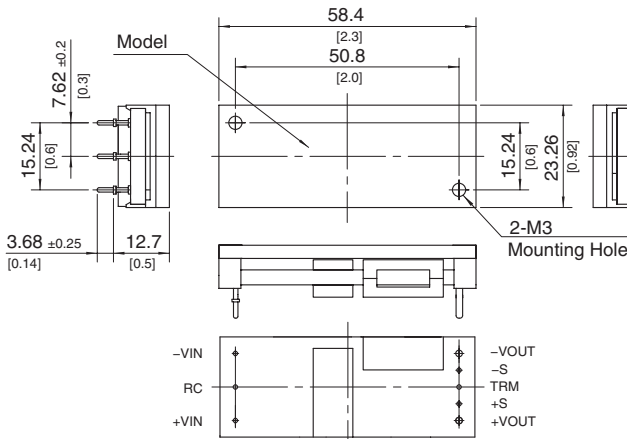

# CQHS300

CQH S 300 48 50 -□

① ② ③ ④ ⑤ ⑥

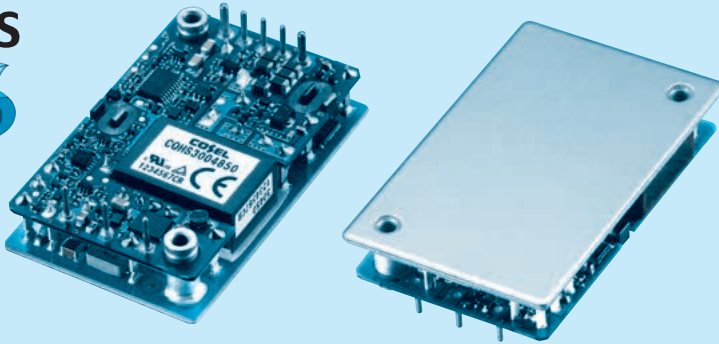
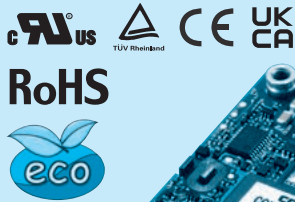

\* Providing heat sink as option

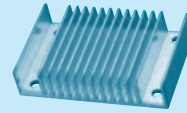

- ① Series name
- ② Single output
- ③ Output wattage
- ④ Input voltage  
48:DC36 - 76V
- ⑤ Output voltage
- ⑥ Optional
- R :with Remote ON/OFF  
Positive logic control
- T :with Mounting hole  
φ 3.4 thru

MODEL	CQHS3004832	CQHS3004850
MAX OUTPUT WATTAGE[W]	300.8	300
DC OUTPUT	32V 9.4A	50V 6A

## SPECIFICATIONS

	MODEL	CQHS3004832	CQHS3004850	
INPUT	VOLTAGE[V]	DC36 - 76		
	CURRENT[A]	6.67typ	6.65typ	
	EFFICIENCY[%]	94typ	94typ	
	START-UP VOLTAGE[V]	DC32 - 36		
	HYSTERESIS VOLTAGE[V]	DC2 min		
OUTPUT	VOLTAGE[V]	32	50	
	CURRENT[A]	9.4	6.0	
	LINE REGULATION[mV]	64max	100max	
	LOAD REGULATION[mV]	64max	100max	
	RIPPLE[mVp-p]	-20 to +100°C *2	255max	400max
		-40 to -20°C Vin=36-60V *2	320max	500max
		-40 to -20°C Vin=60-76V *2	400max	500max
	RIPPLE NOISE[mVp-p]	-20 to +100°C *2	320max	500max
		-40 to -20°C *2	410max	650max
	TEMPERATURE REGULATION[mV]	0 to +65°C	320max	500max
		-40 to +100°C	640max	1000max
DRIFT[mV]	*3	120max	185max	
START-UP TIME[ms]		200max (DCIN 48V, Io=100%)		
OUTPUT VOLTAGE ADJUSTMENT RANGE[V] *4		Fixed (TRM pin open), adjustable by external resistor		
		27.2 - 35.2	45.0 - 55.0	
OUTPUT VOLTAGE SETTING[V] *1		31.68 - 32.32	49.50 - 50.50	
PROTECTION CIRCUIT AND OTHERS	OVERCURRENT PROTECTION	Works over 105% of rating, low voltage protection (shut down) function is built-in.		
	OVERVOLTAGE PROTECTION[V]	36.80 - 44.80	56.50 - 67.50	
	REMOTE SENSING	Provided		
REMOTE ON/OFF	Provided (Negative Logic L : ON, H :OFF)			
ISOLATION	INPUT-OUTPUT	DC1,500V or AC500V 1minute, Cutoff current = 10mA, DC500V 50MΩ min (20±15°C)		
	INPUT-BASE PLATE	DC1,500V or AC500V 1minute, Cutoff current = 10mA, DC500V 50MΩ min (20±15°C)		
	OUTPUT-BASE PLATE	AC500V 1minute, Cutoff current = 100mA, DC500V 50MΩ min (20±15°C)		
ENVIRONMENT	OPERATING TEMP., HUMID. AND ALTITUDE	-40 to +100°C (On aluminum base plate), 20 - 95%RH (Non condensing) (Refer to "Derating"), 3,000m (10,000 feet) max		
	STORAGE TEMP., HUMID. AND ALTITUDE	-40 to +100°C, 20 - 95%RH (Non condensing), 9,000m (30,000 feet) max		
	VIBRATION	10 - 55Hz, 49.0m/s <sup>2</sup> (5G), 3minutes period, 60minutes each along X, Y and Z axis		
	IMPACT	196.1m/s <sup>2</sup> (20G), 11ms, once each along X, Y and Z axis		
SAFETY	AGENCY APPROVALS	UL60950-1, C-UL (CSA60950-1), EN62368-1		
OTHERS	CASE SIZE/WEIGHT	57.9×12.7×36.8mm [2.28×0.5×1.45 inches] (W×H×D) / 75g max		
	COOLING METHOD	Conduction cooling (e.g. heat radiation from the aluminum base plate to the attached heat sink)		

\*1 At rated input(DC48V), rated load, and aluminum base plate temperature 25°C.  
 \*2 Ripple and ripple noise is measured by using measuring board with recommended capacitor Co & the film capacitor 0.1 μF.  
 \*3 Drift is the change in DC output for an eight hour period after a half-hour warm-up at 25°C, with the input voltage held constant at the rated input/output.  
 \*4 When the input voltage is in the range of DC36-40V, output voltage is limited. Refer to the manual.

External view

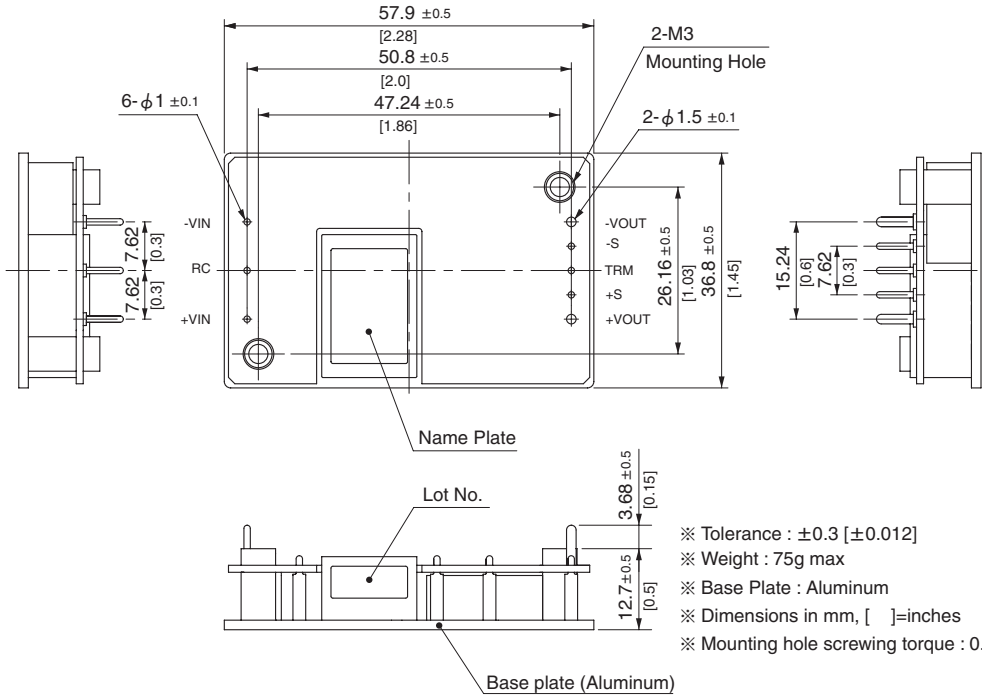

- ※ Tolerance :  $\pm 0.3$  [ $\pm 0.012$ ]
- ※ Weight : 75g max
- ※ Base Plate : Aluminum
- ※ Dimensions in mm, [ ]=inches
- ※ Mounting hole screwing torque :  $0.49\text{N} \cdot \text{m}$  (5.0kgf · cm) max

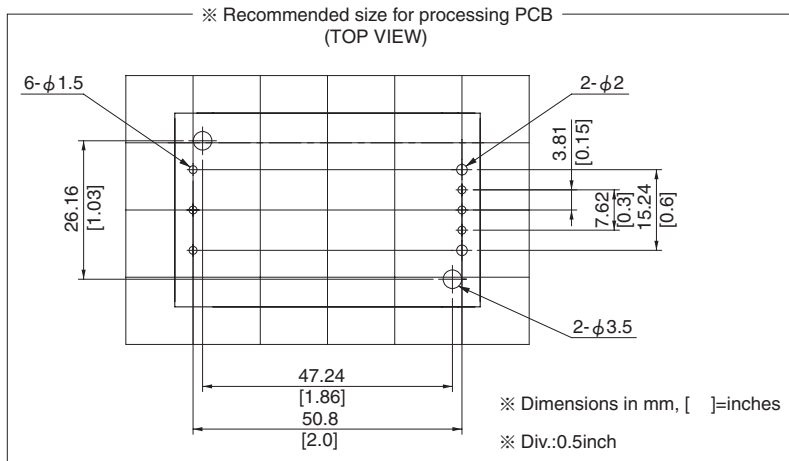

- ※ Dimensions in mm, [ ]=inches
- ※ Div.:0.5inch

# CQHS350

CQH S 350 48 50 -□

① ② ③ ④ ⑤ ⑥

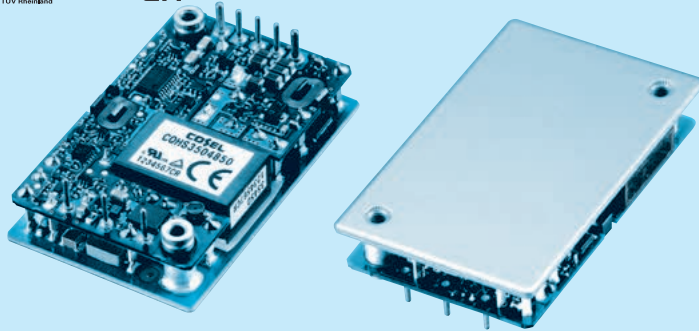
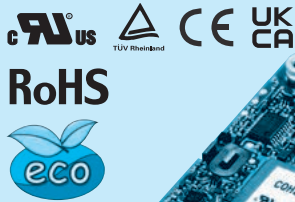

\*Providing heat sink as option

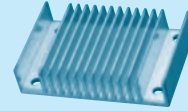

- ① Series name
- ② Single output
- ③ Output wattage
- ④ Input voltage  
48:DC36 - 65V
- ⑤ Output voltage
- ⑥ Optional
- R :with Remote ON/OFF  
Positive logic control
- T :with Mounting hole  
φ 3.4 thru

MODEL	CQHS3504832	CQHS3504850
MAX OUTPUT WATTAGE[W]	352	350
DC OUTPUT	32V 11A	50V 7A

## SPECIFICATIONS

	MODEL	CQHS3504832	CQHS3504850	
INPUT	VOLTAGE[V]	DC36 - 65		
	CURRENT[A]	7.8typ	7.76typ	
	EFFICIENCY[%]	94typ	94typ	
	START-UP VOLTAGE[V]	DC32 - 36		
	HYSTERESIS VOLTAGE[V]	DC2 min		
OUTPUT	VOLTAGE[V]	32	50	
	CURRENT[A]	11.0 *5	7.0	
	LINE REGULATION[mV]	64max	100max	
	LOAD REGULATION[mV]	64max	100max	
	RIPPLE[mVp-p]	-20 to +100°C *2	255max	400max
		-40 to -20°C Vin=36-60V *2	320max	500max
		-40 to -20°C Vin=60-65V *2	400max	500max
	RIPPLE NOISE[mVp-p]	-20 to +100°C *2	320max	500max
		-40 to -20°C *2	410max	650max
	TEMPERATURE REGULATION[mV]	0 to +65°C	320max	500max
		-40 to +100°C	640max	1000max
	DRIFT[mV]	*3	120max	185max
	START-UP TIME[ms]	200max (DCIN 48V, Io=100%)		
OUTPUT VOLTAGE ADJUSTMENT RANGE[V] *4	Fixed (TRM pin open), adjustable by external resistor			
	26.88 - 35.20			
OUTPUT VOLTAGE SETTING[V] *1	45.0 - 55.0			
	49.50 - 50.50			
PROTECTION CIRCUIT AND OTHERS	OVERCURRENT PROTECTION	Works over 105% of rating, low voltage protection (shut down) function is built-in.		
	OVERVOLTAGE PROTECTION[V]	36.80 - 44.80	56.50 - 67.50	
	REMOTE SENSING	Provided		
	REMOTE ON/OFF	Provided (Negative Logic L : ON, H :OFF)		
ISOLATION	INPUT-OUTPUT	DC1,500V or AC500V 1minute, Cutoff current = 10mA, DC500V 50MΩ min (20±15°C)		
	INPUT-BASE PLATE	DC1,500V or AC500V 1minute, Cutoff current = 10mA, DC500V 50MΩ min (20±15°C)		
	OUTPUT-BASE PLATE	AC500V 1minute, Cutoff current = 100mA, DC500V 50MΩ min (20±15°C)		
ENVIRONMENT	OPERATING TEMP., HUMID. AND ALTITUDE	-40 to +100°C (On aluminum base plate), 20 - 95%RH (Non condensing) (Refer to "Derating"), 3,000m (10,000 feet) max		
	STORAGE TEMP., HUMID. AND ALTITUDE	-40 to +100°C, 20 - 95%RH (Non condensing), 9,000m (30,000 feet) max		
	VIBRATION	10 - 55Hz, 49.0m/s <sup>2</sup> (5G), 3minutes period, 60minutes each along X, Y and Z axis		
	IMPACT	196.1m/s <sup>2</sup> (20G), 11ms, once each along X, Y and Z axis		
SAFETY	AGENCY APPROVALS	UL60950-1, C-UL (CSA60950-1), EN62368-1		
OTHERS	CASE SIZE/WEIGHT	57.9×12.7×36.8mm [2.28×0.5×1.45 inches] (W×H×D) / 75g max		
	COOLING METHOD	Conduction cooling (e.g. heat radiation from the aluminum base plate to the attached heat sink)		

\*1 At rated input(DC48V), rated load, and aluminum base plate temperature 25°C.  
 \*2 Ripple and ripple noise is measured by using measuring board with recommended capacitor Co & the film capacitor 0.1 μF.  
 \*3 Drift is the change in DC output for an eight hour period after a half-hour warm-up at 25°C, with the input voltage held constant at the rated input/output.  
 \*4 When the input voltage is in the range of DC36-40V, output voltage is limited. Refer to the manual.  
 \*5 Rated current is increased adjusting output voltage to lower than rated output voltage. Refer to the manual.

External view

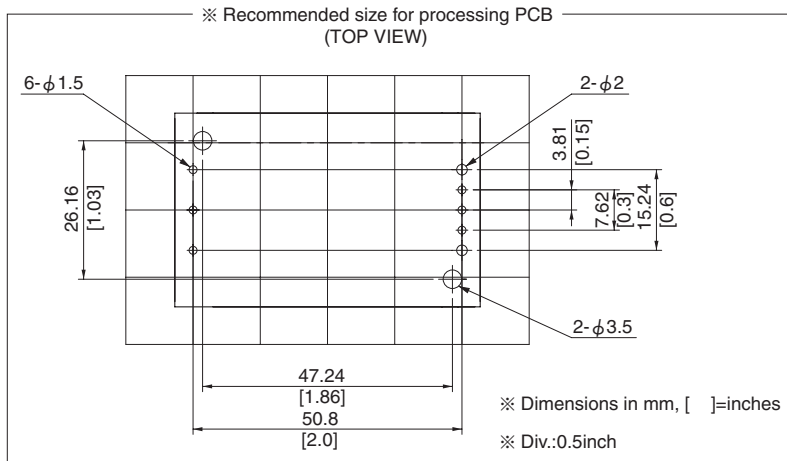
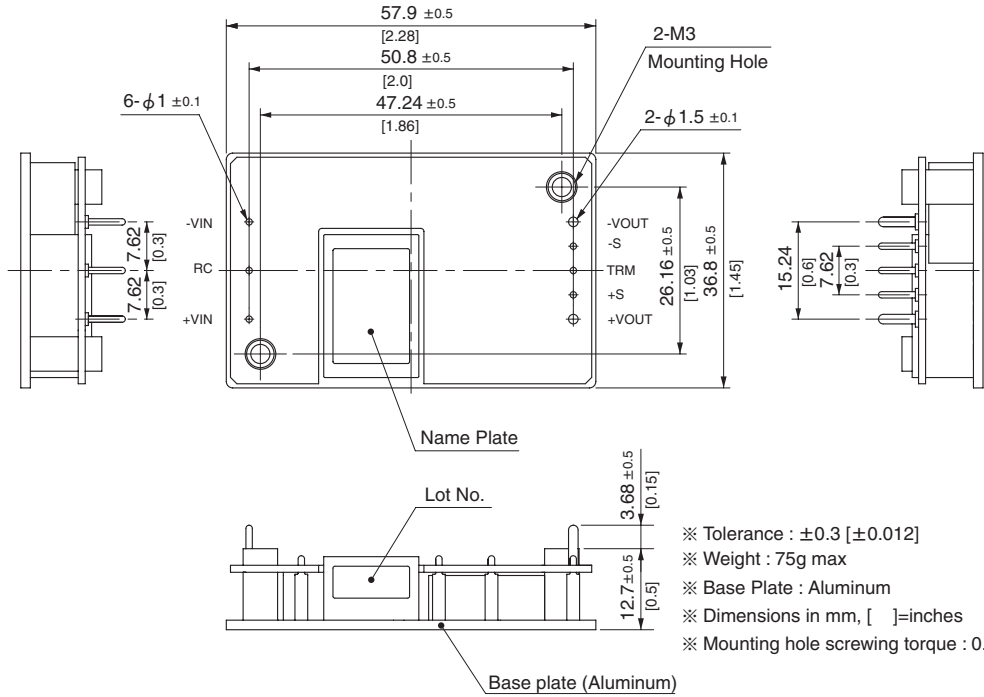



## Pin Configuration

### ● CQHS250

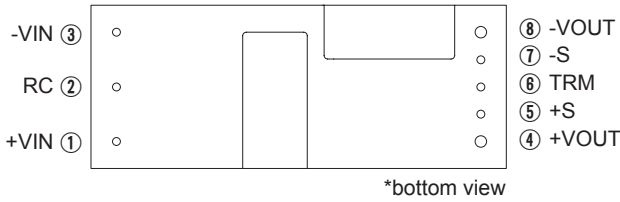

No.	Pin Name	Function
①	+VIN	+DC input
②	RC	Remote ON/OFF
③	-VIN	-DC input
④	+VOUT	+DC output
⑤	+S	+Remote sensing
⑥	TRM	Adjustment of output voltage
⑦	-S	-Remote sensing
⑧	-VOUT	-DC output
-	Mounting hole	Mounting hole

### ● CQHS300/CQHS350

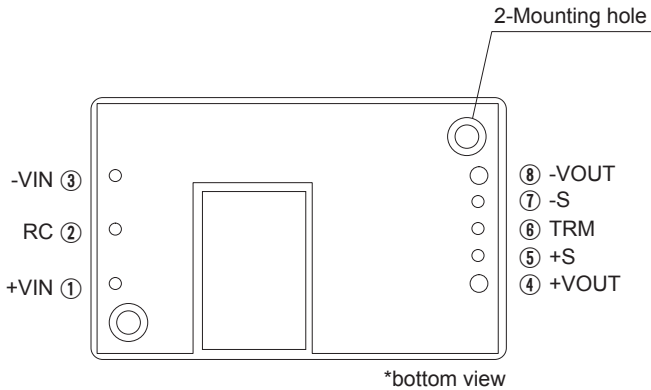

## Implementation · Mounting Method

### Mounting method

- When multiple power modules are used side by side, position them with sufficient spaces to allow adequate air ventilation so that the temperature of each power module will remain within the temperature range shown in the “Derating”.
- Do not pass the DC input pattern underneath the power module as this will increase conducted noise. Place the DC input pattern away from the power module. Do not pass the DC output pattern underneath the power module as this will increase output noise. Place the DC output pattern away from the power module.
- High frequency noise is radiated from the power module. When mounting the power module on a PCB, leave a copper pattern on the PCB to let it act as a shield and connect this pattern to the mounting hole.
- Avoid placing pattern layout in hatched area shown in right figure to insulate between pattern and power supply.

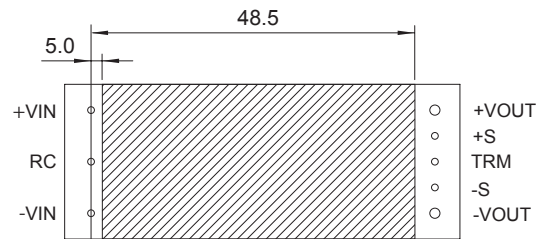

### ● CQHS300/CQHS350

- Soldering CQHS series with printed board must be done under the flat condition by using the mounting hole and fixing with the screw.  
If CQHS series is inclined and it's mounted, the insulation of the internal components and printed board might not be kept.
- When a heat sink cannot be fixed on the base plate side, order the power module with “-T” option. A heat sink can be mounted by affixing a M3 tap on the heat sink.  
Please make sure a mounting hole will be connected to a grounding capacitor CY.

	Mounting hole
Standard	M3 tapped
Optional : -T	φ 3.4 thru



Implementation · Mounting Method

Stress onto the pins

- Applying excessive stress to the input or output pins of the power module may damage internal connections. Avoid applying stress in excess of that shown in below.
- Input and output pins are soldered onto the internal PCB. Do not bend or pull the leads with excessive force.

●CQHS250

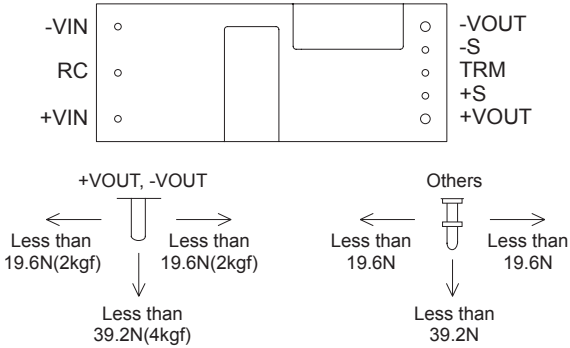

●CQHS300/CQHS350

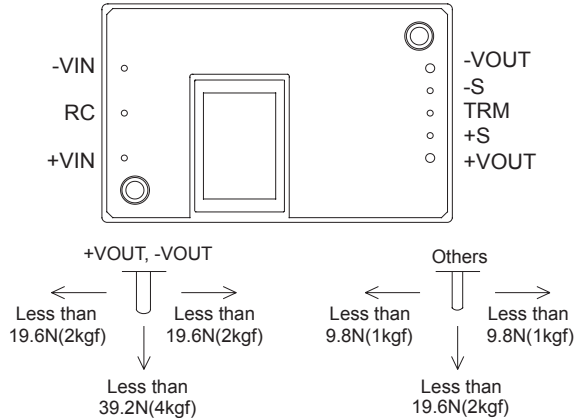

●CQHS300/CQHS350

- As unexpected stress may be applied to the pins, set the diameter of the PCB mounting hole at 3.5mm.
- As unexpected stress may be applied to the pins from vibration or shock, fix the power module by using the mounting holes screws to reduce stress.
- Fix the power module to the PCB with the screws before soldering the input and output pins to prevent the PCB pattern being damaged.

Soldering temperature

- Flow soldering : 260°C for up to 15 seconds.
- Soldering iron (26W) : 450°C for up to 5 seconds.

Derating

- It is necessary to note the thermal fatigue life by power cycle. Please reduce the temperature fluctuation range as much as possible when the up and down of the temperature are frequently generated. Contact us for more information on cooling methods.

●CQHS250

- Use with the convection cooling or the forced air cooling. Make sure the temperatures at temperature measurement locations shown below are on or under the derating curve. Ambient temperature must be kept at 85°C or under.

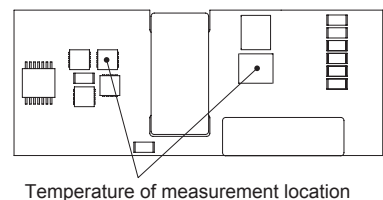
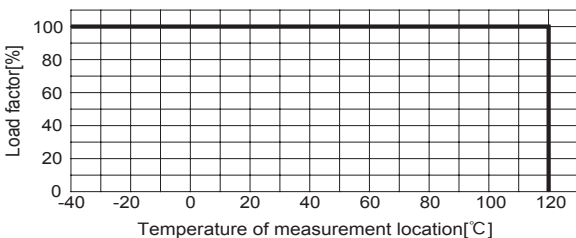

- For option “B” which is used with the convection cooling, forced air cooling or conduction cooling, use the temperature measurement location as shown in below.

Derating

① Vin=DC36-60V

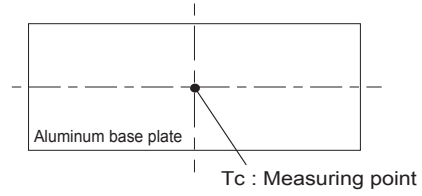
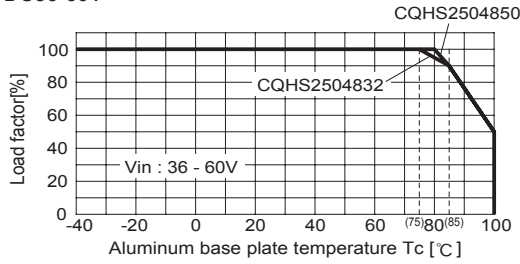

② Vin=DC60-76V

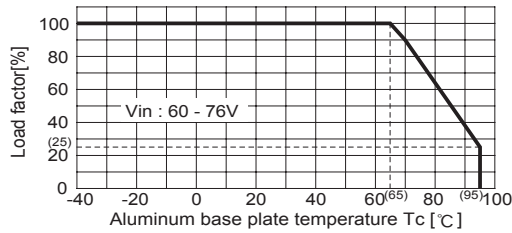

● CQHS300/CQHS350

■ Use the power modules with conduction cooling (e.g. heat dissipation from the aluminum base plate to the attached heat sink).

Below figure shows the derating curves with respect to the aluminum base plate temperature. Note that operation within the hatched areas will cause a significant level of ripple and ripple noise. Contact us for more information on cooling methods.

■ Please measure the temperature on the aluminum base plate edge side when you cannot measure the temperature of the center part of the aluminum base plate. In this case, please take 5deg temperature margin from the derating characteristic of below figure .

① Vin=DC36-60V

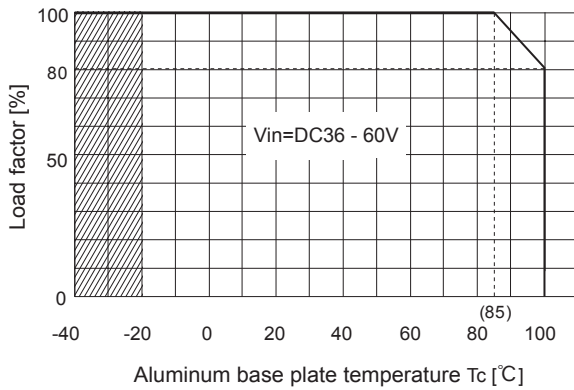

② CQHS300 : Vin=DC60 - 76V CQHS350 : Vin=DC60 - 65V

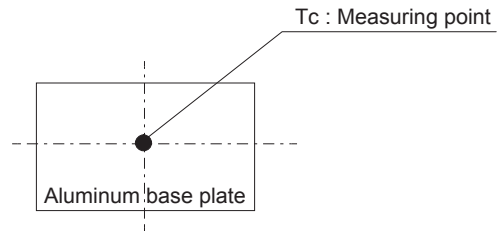
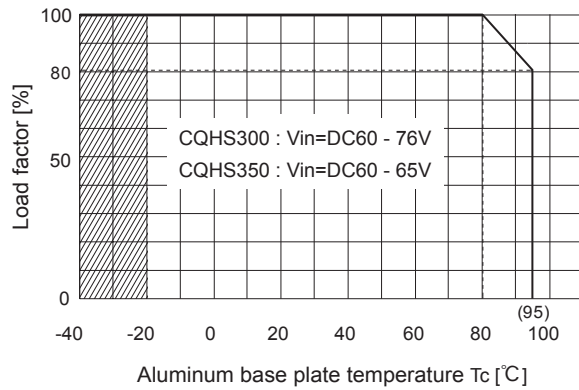

Instruction Manual

◆ It is necessary to read the "Instruction Manual" and "Before using our product" before you use our product.

Instruction Manual <https://www.cosel.co.jp/redirect/catalog/en/CQHS/>  
 Before using our product <https://en.cosel.co.jp/technical/caution/index.html>

CQHS



NOTICE



### Basic Characteristics Data

Model	Circuit method	Switching frequency [kHz]	Input current	Rated input fuse	Inrush current protection	PCB/Pattern			Series/Redundancy operation availability	
						Material	Single sided	Double sided	Series operation	Redundancy operation
CQHS250	Full-bridge converter	140	*1	-	-	glass fabric base, epoxy resin		Multilayer	Yes	*2
CQHS300	Forward converter	250	*1	-	-	Aluminum	Yes		Yes	*2
CQHS350	Forward converter	250	*1	-	-	Aluminum	Yes		Yes	*2

\*1 Refer to Specification.

\*2 Refer to Instruction Manual.

# Mouser Electronics

Authorized Distributor

Click to View Pricing, Inventory, Delivery & Lifecycle Information:

Cosel:

[CQHS3004850-T](#) [CQHS3004832](#) [CQHS3004832-T](#) [CQHS3004832-RT](#) [CQHS3004850-R](#) [CQHS3004850-RT](#)  
[CQHS3004850](#) [CQHS3004832-R](#) [CQHS3504850](#) [CQHS2504832](#) [CQHS3504832](#) [CQHS2504850](#)