

# MAC212A8, MAC212A10

Triacs – 400V - 800V

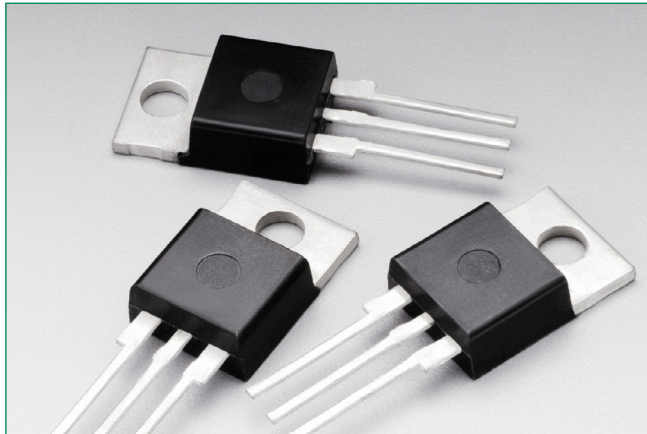

## Description

Designed primarily for full-wave AC control applications, such as light dimmers, motor controls, heating controls and power supplies; or wherever full-wave silicon gate controlled solid-state devices are needed. Triac type thyristors switch from a blocking to a conducting state for either polarity of applied main terminal voltage with positive or negative gate triggering.

## Features & Benefits

- Blocking Voltage to 800 Volts
- All Diffused and Glass Passivated Junctions for Greater Parameter Uniformity and Stability
- Small, Rugged, Thermowatt Construction for Low Thermal Resistance, High Heat Dissipation and Durability
- Gate Triggering Guaranteed in Four Modes (Quadrants)
- Pb-Free Packages are Available

## Additional Information



Resources



Accessories



Samples

## Functional Diagram

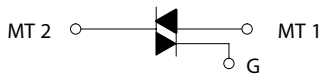

## Pin Out

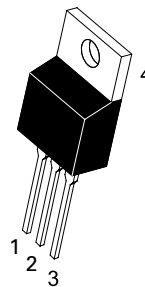

**TO-220AB  
CASE 221A  
STYLE 4**

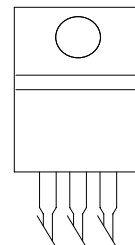

# MAC212A8, MAC212A10

## Triacs – 400V - 800V

### Maximum Ratings ( $T_J = 25^\circ\text{C}$ unless otherwise noted)

Rating	Symbol	Value	Unit
Peak Repetitive Off-State Voltage (Note 1) (– 40 to 125°C, Sine Wave, 50 to 60 Hz, Gate Open)	MAC212A8	600 800	V
	MAC212A10	800	
On-State RMS Current (Full Cycle Sine Wave, 50 to 60 Hz, $T_C = +85^\circ\text{C}$ )	$I_{T(RMS)}$	12	A
Peak Non-Repetitive Surge Current (One Full Cycle Sine Wave, 60 Hz, $T_C = +25^\circ\text{C}$ ) Preceded and followed by rated current	$I_{TSM}$	100	A
Circuit Fusing Considerations ( $t = 8.3$ ms)	$I^2t$	40	A <sup>2</sup> sec
Peak Gate Power ( $T_C = +85^\circ\text{C}$ , Pulse Width = 10 $\mu\text{s}$ )	$P_{GM}$	20	W
Average Gate Power ( $t = 8.3$ ms, $T_C = +85^\circ\text{C}$ )	$P_{G(AV)}$	0.35	W
Peak Gate Current ( $T_C = +85^\circ\text{C}$ , Pulse Width = 10 $\mu\text{s}$ )	$I_{GM}$	2.0	A
Operating Junction Temperature Range	$T_J$	-40 to +125	°C
Storage Temperature Range	$T_{stg}$	-40 to +150	°C

Maximum ratings are those values beyond which device damage can occur. Maximum ratings applied to the device are individual stress limit values (not normal operating conditions) and are not valid simultaneously. If these limits are exceeded, device functional operation is not implied, damage may occur and reliability may be affected.

1.  $V_{DRM}$  and  $V_{RRM}$  for all types can be applied on a continuous basis. Ratings apply for zero or negative gate voltage; however, positive gate voltage shall not be applied concurrent with negative potential on the anode. Blocking voltages shall not be tested with a constant current source such that the voltage ratings of the devices are exceeded.

### Thermal Characteristics

Rating	Symbol	Value	Unit
Thermal Resistance, Junction-to-Case (AC) Junction-to-Ambient	$R_{\theta JC}$	2.0	°C/W
	$R_{\theta JA}$	62.5	
Maximum Lead Temperature for Soldering Purposes, 1/8" from case for 10 seconds	$T_L$	260	°C

### Electrical Characteristics - OFF ( $T_J = 25^\circ\text{C}$ unless otherwise noted ; Electricals apply in both directions)

Characteristic	Symbol	Min	Typ	Max	Unit	
Peak Repetitive Blocking Current ( $V_D = V_{DRM} = V_{RRM}$ ; Gate Open)	$I_{DRM}$ $I_{RRM}$	$T_J = 25^\circ\text{C}$	-	-	10	$\mu\text{A}$
		$T_J = 125^\circ\text{C}$	-	-	2.0	mA

### Electrical Characteristics - ON ( $T_J = 25^\circ\text{C}$ unless otherwise noted; Electricals apply in both directions)

Characteristic	Symbol	Min	Typ	Max	Unit	
Peak On-State Voltage ( $I_{TM} = 17$ A Peak; Pulse Width = 1 to 2 ms, Duty Cycle $\leq 2\%$ )	$V_{TM}$	-	1.3	1.75	V	
Gate Trigger Current (Continuous dc) (Main Terminal Voltage = 12 Vdc, $R_L = 100 \Omega$ )	$I_{GT}$	MT2(+), G(+)	-	12	50	mA
		MT2(+), G(-)	-	12	50	
		MT2(-), G(-)	-	20	50	
		MT2(-), G(+)	-	35	75	
Gate Trigger Voltage (Continuous dc) (Main Terminal Voltage = 12 Vdc, $R_L = 100 \Omega$ )	$V_{GT}$	MT2(+), G(+)	-	0.9	2.0	V
		MT2(+), G(-)	-	0.9	2.0	
		MT2(-), G(-)	-	1.1	2.0	
		MT2(-), G(+)	-	1.4	2.5	
Gate Non-Trigger Voltage (Continuous dc) Main Terminal Voltage = 12 V, $R_L = 100 \Omega$ , $T_J = +125^\circ\text{C}$ ) All Four Quadrants	$V_{GD}$	0.2	-	-	V	
Holding Current (Main Terminal Voltage = 12 Vdc, Gate Open, Initiating Current = $\pm 200$ mA)	$I_H$	-	6.0	50	mA	
Turn-On Time (Rated $V_{DRM}$ , $I_{TM} = 17$ A) ( $I_{GT} = 120$ mA, Rise Time = 0.1 $\mu\text{s}$ , Pulse Width = 2 $\mu\text{s}$ )	$t_{gt}$	-	1.5	-	$\mu\text{s}$	

# MAC212A8, MAC212A10

## Triacs – 400V - 800V

### Dynamic Characteristics

Characteristic	Symbol	Min	Typ	Max	Unit
Critical Rate of Rise of Commutation Voltage ( $V_D = \text{Rated } V_{DRM}$ , $I_{TM} = 17 \text{ A}$ , Commutating $di/dt = 6.1 \text{ A/ms}$ , Gate Unenergized, $T_c = +85^\circ\text{C}$ )	$di/dt_{(c)}$	–	5.0	–	V/ $\mu\text{s}$
Critical Rate of Rise of Off-State Voltage ( $V_D = \text{Rated } V_{DRM}$ , Exponential Waveform, Gate Open, $T_c = +85^\circ\text{C}$ )	$dv/dt$	–	100	–	V/ $\mu\text{s}$

### Voltage Current Characteristic of SCR

Symbol	Parameter
$V_{DRM}$	Peak Repetitive Forward Off State Voltage
$I_{DRM}$	Peak Forward Blocking Current
$V_{RRM}$	Peak Repetitive Reverse Off State Voltage
$I_{RRM}$	Peak Reverse Blocking Current
$V_{TM}$	Maximum On State Voltage
$I_H$	Holding Current

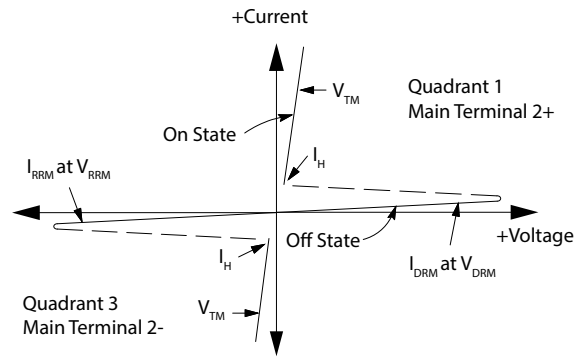

### Quadrant Definitions for a Triac

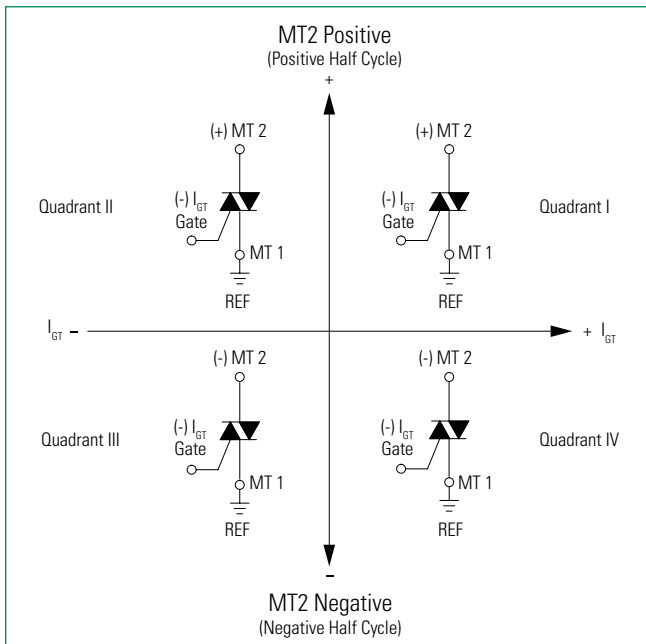

All Polarities are referenced to MT1.  
With in-phase signals (using standard AC lines) quadrants I and III are used

# MAC212A8, MAC212A10

Triacs – 400V - 800V

**Figure 1.**  
Current Derating

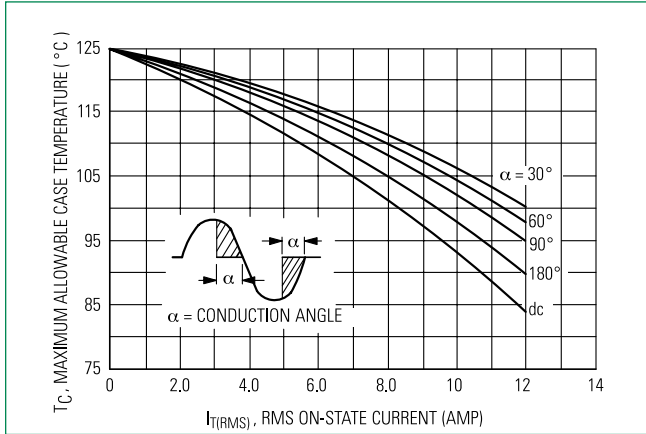

**Figure 2.**  
Power Dissipation

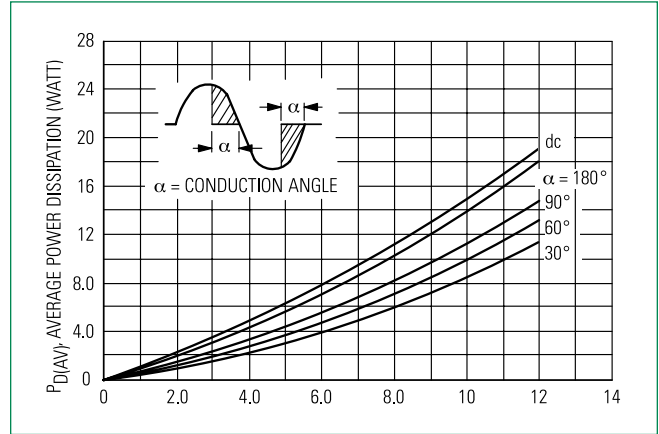

**Figure 3.**  
Maximum On-State Characteristics

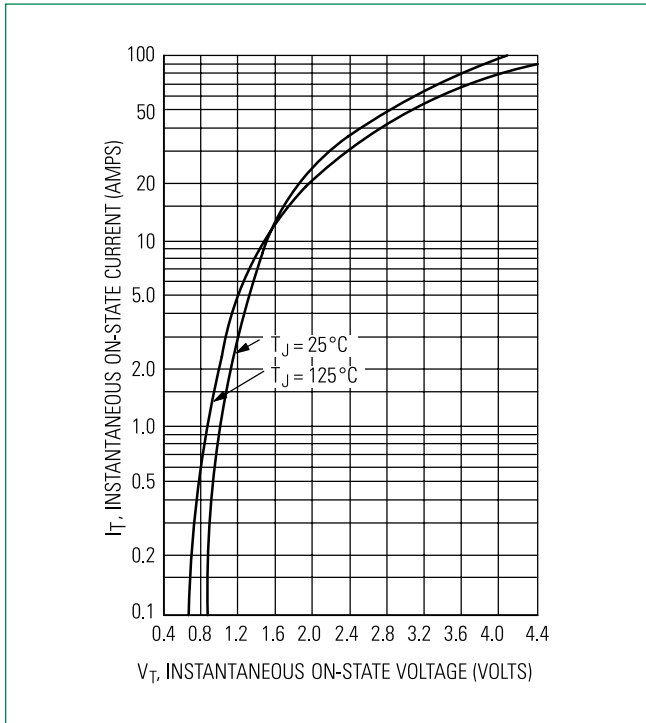

**Figure 4.**  
Maximum Non-Repetitive Surge Current

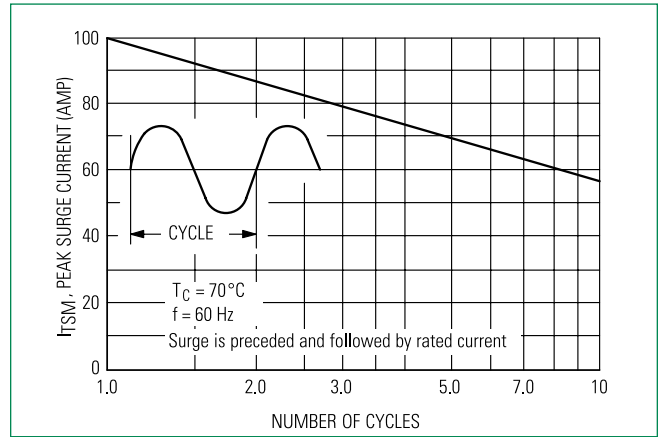

**Figure 5.**  
Typical Gate Trigger Voltage

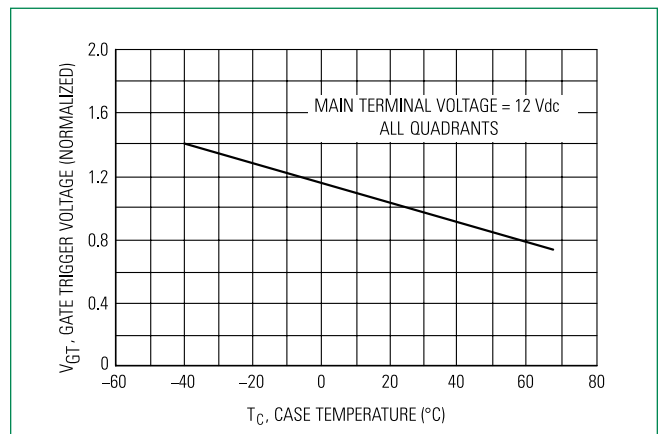

# MAC212A8, MAC212A10

Triacs – 400V - 800V

**Figure 6.**  
Typical Gate Trigger Current

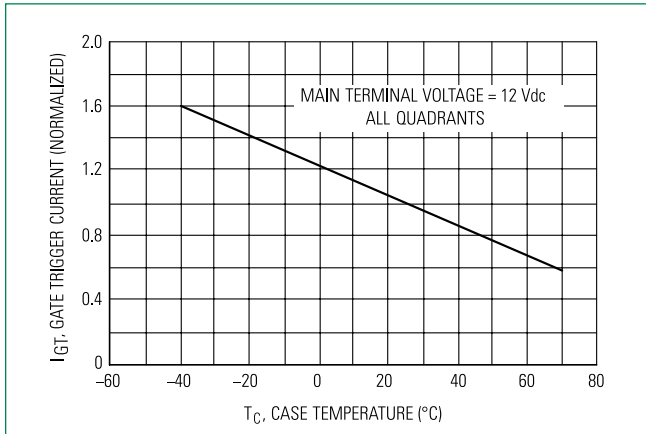

**Figure 7.**  
Typical Holding Current

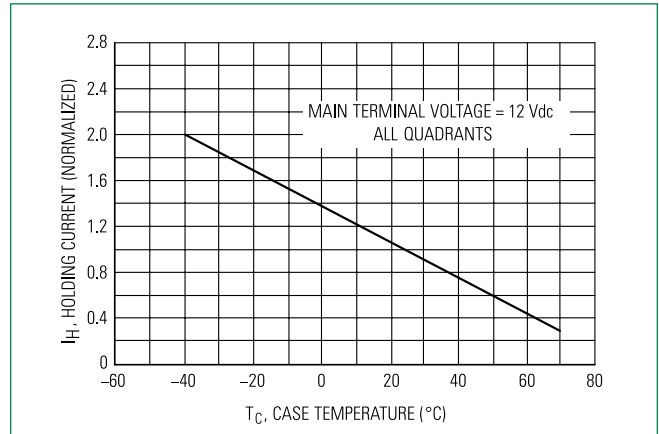

**Figure 8.**  
Thermal Response

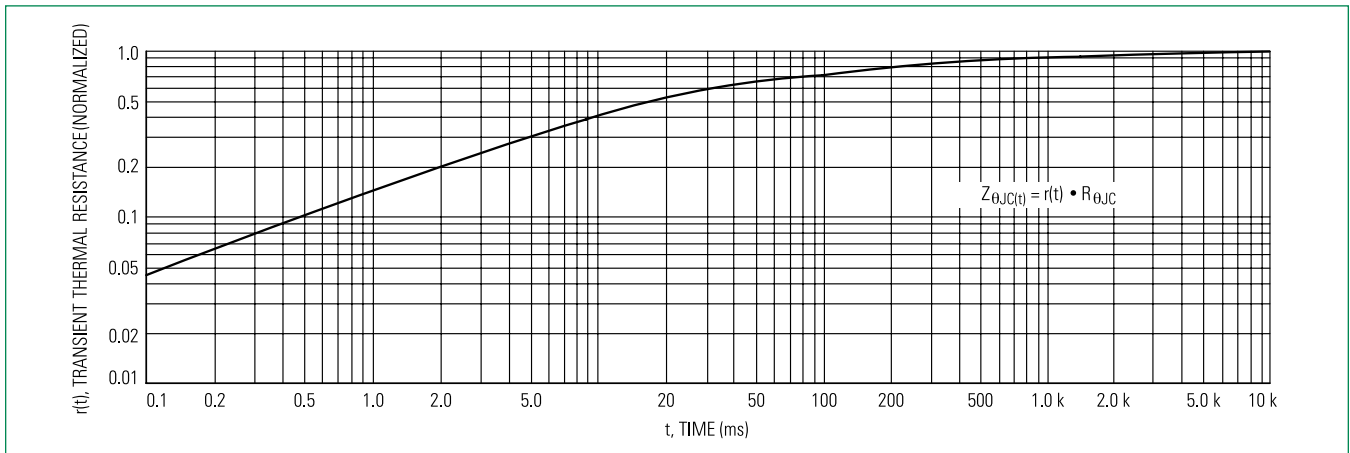

# MAC212A8, MAC212A10

Triacs – 400V - 800V

## Dimensions

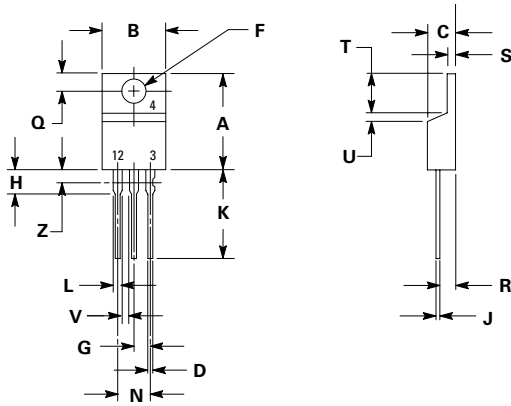

## Part Marking System

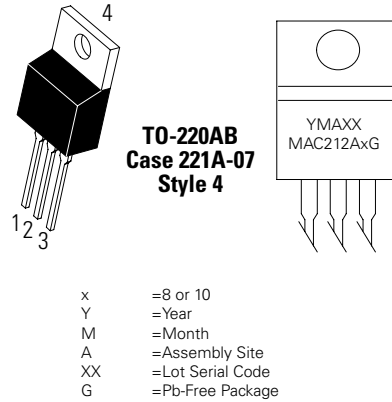

Dim	Inches		Millimeters	
	Min	Max	Min	Max
A	0.590	0.620	14.99	15.75
B	0.380	0.420	9.65	10.67
C	0.178	0.188	4.52	4.78
D	0.025	0.035	0.64	0.89
F	0.142	0.147	3.61	3.73
G	0.095	0.105	2.41	2.67
H	0.110	0.130	2.79	3.30
J	0.018	0.024	0.46	0.61
K	0.540	0.575	13.72	14.61
L	0.060	0.075	1.52	1.91
N	0.195	0.205	4.95	5.21
Q	0.105	0.115	2.67	2.92
R	0.085	0.095	2.16	2.41
S	0.045	0.060	1.14	1.52
T	0.235	0.255	5.97	6.47
U	0.000	0.050	0.00	1.27
V	0.045	—	1.15	—
Z	—	0.080	—	2.04

1. Dimensioning and tolerancing per ansi y14.5m, 1982.
2. Controlling dimension: inch.
3. Dimension z defines a zone where all body and lead irregularities are allowed.

Pin Assignment	
1	Cathode
2	Anode
3	Gate
4	Anode

## Ordering Information

Device	Package	Shipping
MAC212A8	TO-220AB	1000 Units/ Box
MAC212A8G	TO-220AB (Pb-Free)	
MAC212A10	TO-220AB	
MAC212A10G	TO-220AB (Pb-Free)	

**Disclaimer Notice** - Information furnished is believed to be accurate and reliable. However, users should independently evaluate the suitability of and test each product selected for their own applications. Littelfuse products are not designed for, and may not be used in, all applications. Read complete Disclaimer Notice at <http://www.littelfuse.com/disclaimer-electronics>.

# Mouser Electronics

Authorized Distributor

Click to View Pricing, Inventory, Delivery & Lifecycle Information:

[Littelfuse:](#)

[MAC212A8G](#) [MAC212A10G](#)