



Photocoupler Product Data Sheet

LTV-816/ 826/ 846

(M, S, S-TA, S-TA1, S-TP,
S-TP1) Series

Spec No. :DS-70-97-0013

Effective Date: 08/09/2017

Revision: K

LITE-ON DCC

RELEASE

BNS-OD-FC001/A4

LITE-ON Technology Corp. / Optoelectronics

No.90,Chien 1 Road, Chung Ho, New Taipei City 23585, Taiwan, R.O.C.

Tel: 886-2-2222-6181 Fax: 886-2-2221-1948 / 886-2-2221-0660

<http://www.liteon.com/opto>

1. DESCRIPTION

1.1 Features

- Current transfer ratio (CTR : MIN. 50% at $I_F = 5\text{mA}$, $V_{CE} = 5\text{V}$)
- High input-output isolation voltage ($V_{iso} = 5,000\text{Vrms}$)
- Response time (t_r : TYP. $4\mu\text{s}$ at $V_{CE} = 2\text{V}$, $I_C = 2\text{mA}$, $R_L = 100\Omega$)
- Dual-in-line package :
 - LTV-816 : 1-channel type
 - LTV-826 : 2-channel type
 - LTV-846 : 4-channel type
- Wide lead spacing package :
 - LTV-816M : 1-channel type
 - LTV-826M : 2-channel type
 - LTV-846M : 4-channel type
- Surface mounting package :
 - LTV-816S : 1-channel type
 - LTV-826S : 2-channel type
 - LTV-846S : 4-channel type
- Tape and reel packaging :
 - LTV-816S-TA : 1-channel type
 - LTV-816S-TA1 : 1-channel type
 - LTV-816S-TP : 1-channel type
 - LTV-816S-TP1 : 1-channel type
 - LTV-826S-TA : 2-channel type
 - LTV-826S-TA1 : 2-channel type
- Safety approval
 - UL 1577
 - VDE DIN EN60747-5-5 (VDE 0884-5)
 - CSA CA5A
 - CQC GB4943.1-2011/ GB8898-2011 (meet Altitude up to 5000m)
 - Nordic Safety (FIMKO/NEMKO/SEMKO/DEMKO)
 - BSI
- RoHS Compliance
 - All materials be used in device are followed EU RoHS directive (No.2002/95/EC).
- ESD pass HBM 8000V/MM2000V
- MSL class1

1.2 Applications

- Hybrid substrates that require high density mounting.
- Programmable controllers

Photocoupler LTV-8x6 series

2. PACKAGE DIMENSIONS

2.1 LTV-816

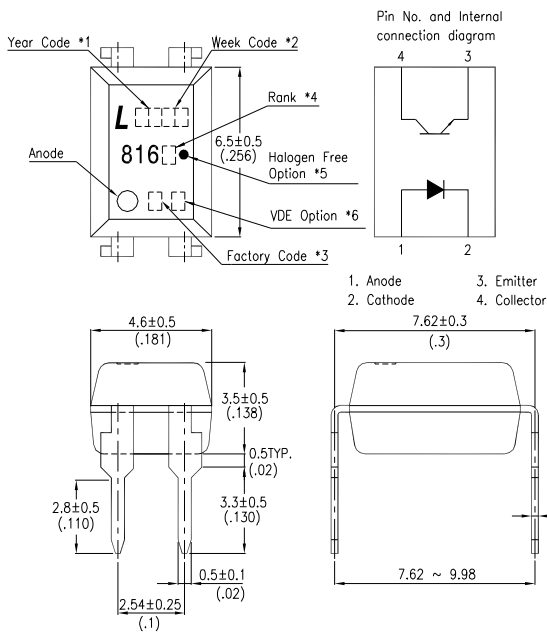

2.2 LTV-816M

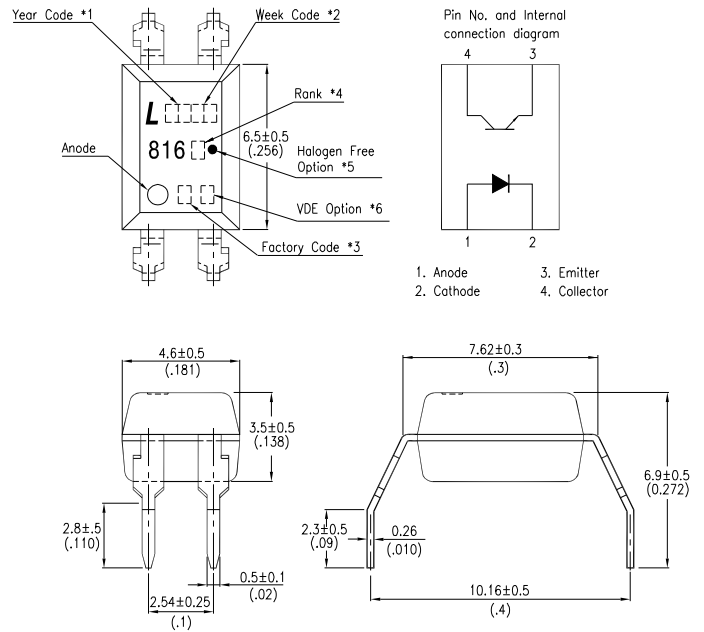

2.3 LTV-816S

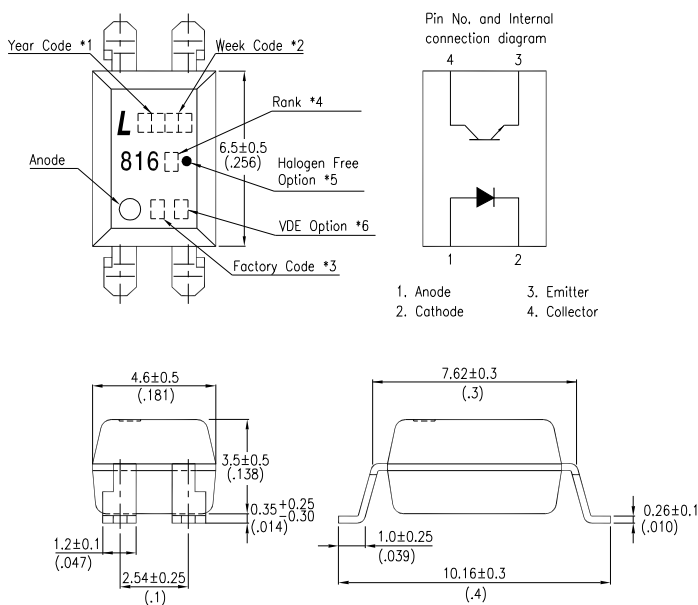

Notes :

1. 2-digit year code.
2. 2-digit work week.
3. Factory identification mark shall be marked (W: China-CZ, Y: Thailand)
4. Rank shall be or shall not be marked.
5. "●" for halogen free option.
6. "4" or "V" for VDE option.

Dimensions in millimeters (inches).

Photocoupler LTV-8x6 series

2.4 LTV-826

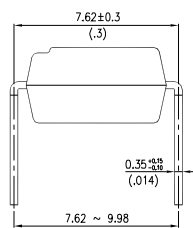
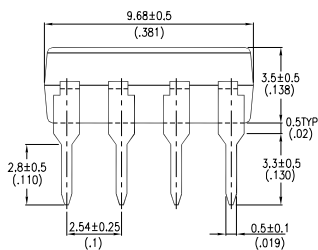
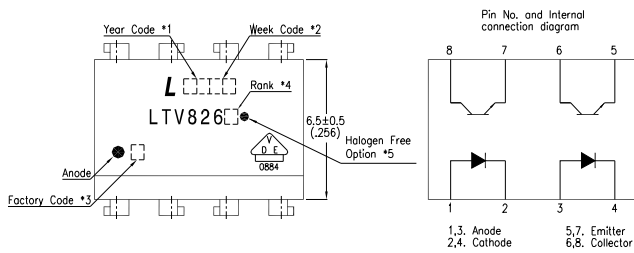

2.5 LTV-826M

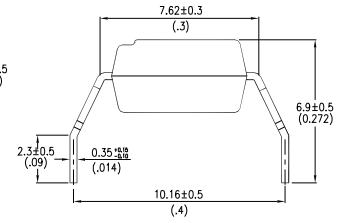
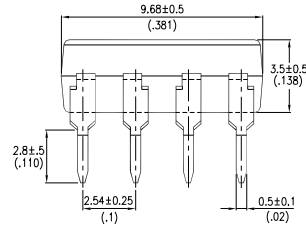
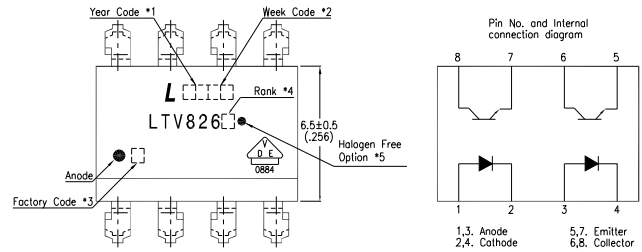

2.6 LTV-826S

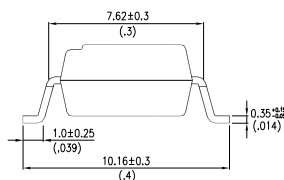
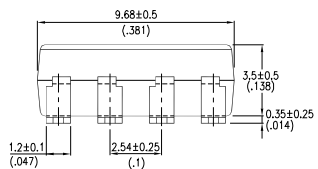
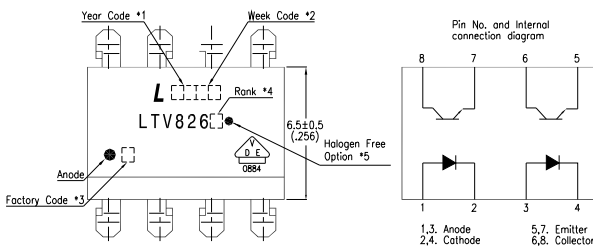

Notes :

- 2-digit year code.
- 2-digit work week.
- Factory identification mark shall be marked (W: China-CZ, Y: Thailand)
- Rank shall be or shall not be marked.
- “●” for halogen free option.
- “” for VDE option.

Dimensions in millimeters (inches).

Photocoupler LTV-8x6 series

2.7 LTV-846

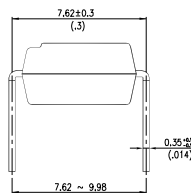
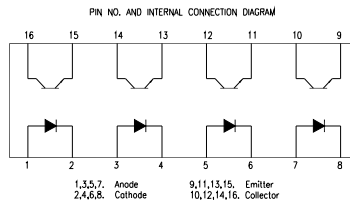
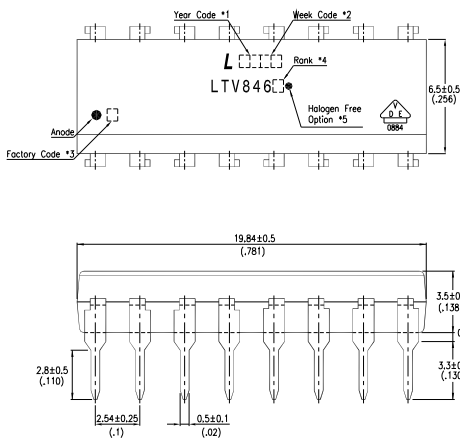

2.8 LTV-846M

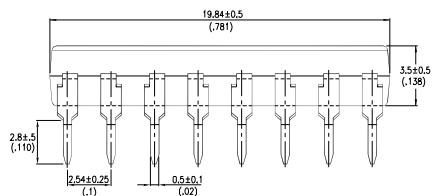
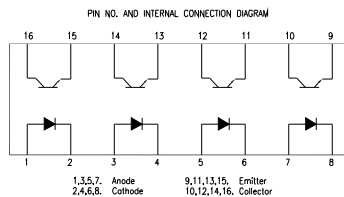
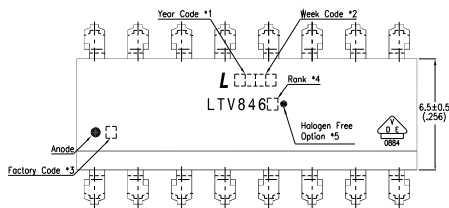

2.9 LTV-846S

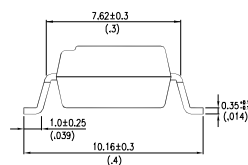
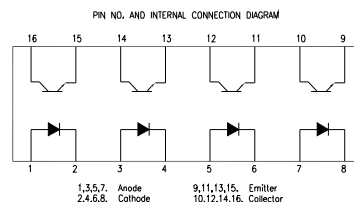
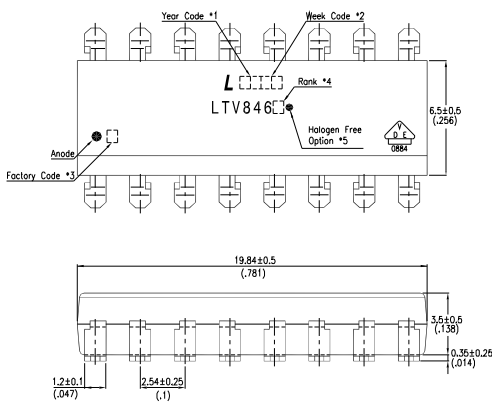

Notes :

1. 2-digit year code.
2. 2-digit work week.
3. Factory identification mark shall be marked (W: China-CZ, Y: Thailand)
4. Rank shall be or shall not be marked.
5. "●" for halogen free option.
6. "0884" for VDE option.

Dimensions in millimeters (inches).

Photocoupler LTV-8x6 series

3. TAPING DIMENSIONS

3.1 LTV-816S-TA

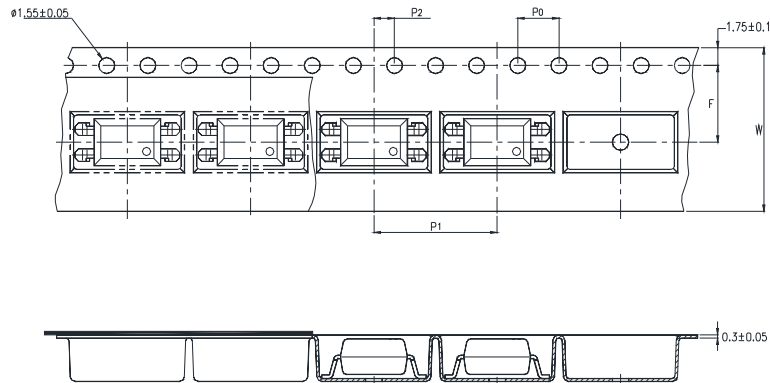

3.2 LTV-816S-TA1

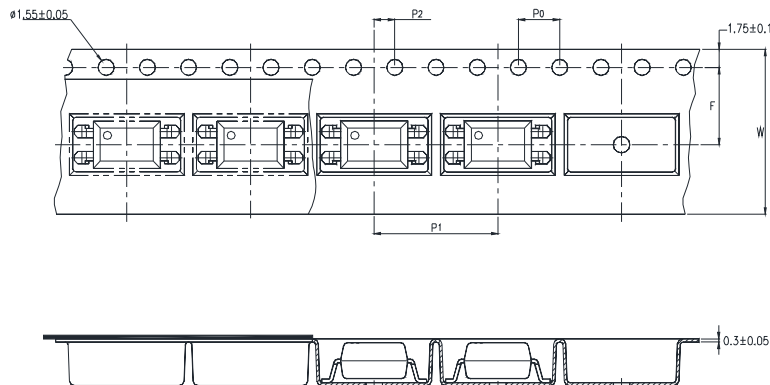

| Description | Symbol | Dimension in mm (inch) |
|--|----------------|------------------------|
| Tape wide | W | 16±0.3 (0.63) |
| Pitch of sprocket holes | P ₀ | 4±0.1 (0.15) |
| Distance of compartment | F | 7.5±0.1 (0.295) |
| | P ₂ | 2±0.1 (0.079) |
| Distance of compartment to compartment | P ₁ | 12±0.1 (0.472) |

3.3 Quantities Per Reel

| Package Type | TA / TA1 |
|------------------|----------|
| Quantities (pcs) | 1000 |

Photocoupler LTV-8x6 series

3.4 LTV-816S-TP

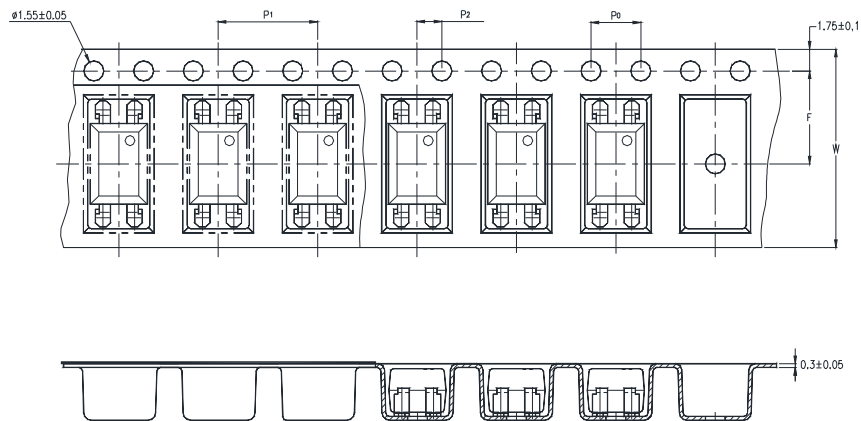

3.5 LTV-816S-TP1

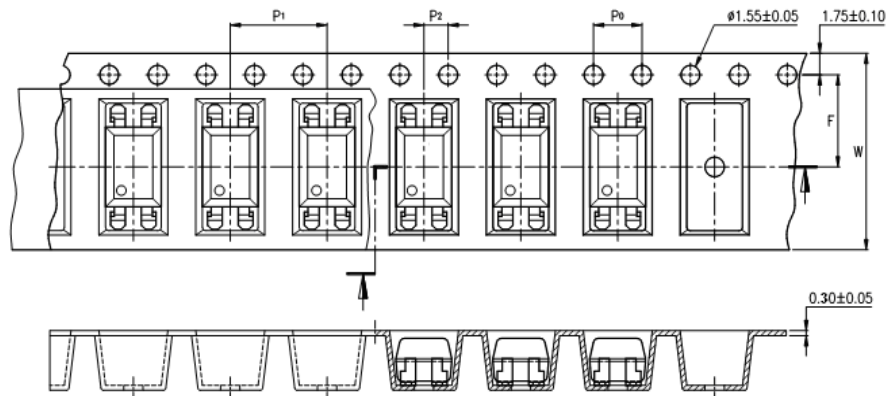

| Description | Symbol | Dimension in mm (inch) |
|--|----------------|------------------------|
| Tape wide | W | 16±0.3 (0.63) |
| Pitch of sprocket holes | P ₀ | 4±0.1 (0.15) |
| Distance of compartment | F | 7.5±0.1 (0.295) |
| | P ₂ | 2±0.1 (0.079) |
| Distance of compartment to compartment | P ₁ | 8±0.1 (0.472) |

3.6 Quantities Per Reel

| Package Type | TP / TP1 |
|------------------|----------|
| Quantities (pcs) | 2000 |

Photocoupler LTV-8x6 series

3.7 LTV-826S-TA

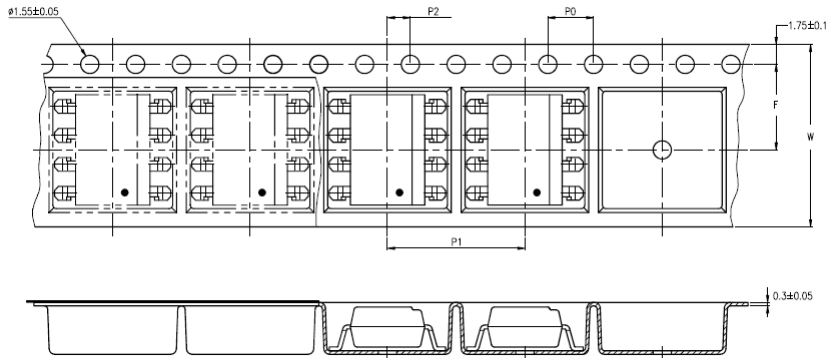

3.8 LTV-826S-TA1

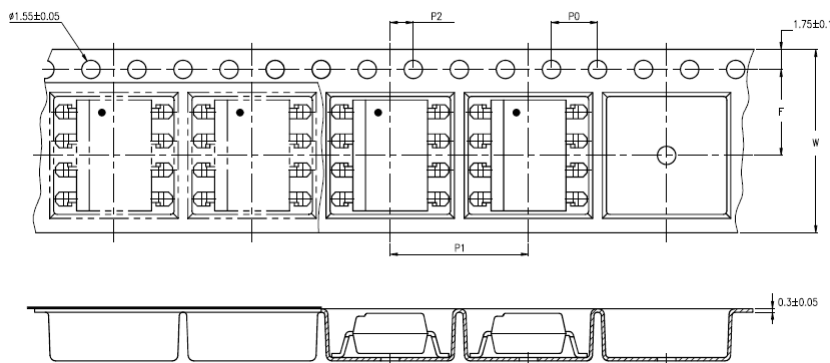

| Description | Symbol | Dimension in mm (inch) |
|--|----------------|------------------------|
| Tape wide | W | 16±0.3 (0.63) |
| Pitch of sprocket holes | P ₀ | 4±0.1 (0.15) |
| Distance of compartment | F | 7.5±0.1 (0.295) |
| | P ₂ | 2±0.1 (0.079) |
| Distance of compartment to compartment | P ₁ | 12±0.1 (0.47) |

3.9 Quantities Per Reel

| Package Type | TA / TA1 |
|------------------|----------|
| Quantities (pcs) | 1000 |

Photocoupler LTV-8x6 series

4. RATING AND CHARACTERISTICS

4.1 Absolute Maximum Ratings at Ta=25°C

| | Parameter | Symbol | Rating | Unit |
|--------|-------------------------------------|-----------|------------|-----------|
| Input | Forward Current | I_F | 50 | mA |
| | Reverse Voltage | V_R | 6 | V |
| | Power Dissipation | P | 70 | mW |
| | Junction Temperature | T_J | 125 | °C |
| Output | Collector - Emitter Voltage | V_{CEO} | 80 | V |
| | Emitter - Collector Voltage | V_{ECO} | 6 | V |
| | Collector Current | I_C | 50 | mA |
| | Collector Power Dissipation | P_C | 150 | mW |
| | Total Power Dissipation | P_{tot} | 200 | mW |
| 1. | Isolation Voltage | V_{iso} | 5000 | V_{rms} |
| | Operating Temperature (LTV-826/846) | T_{opr} | -30 ~ +100 | °C |
| | Operating Temperature (LTV-816) | T_{opr} | -55 ~ +110 | °C |
| | Storage Temperature | T_{stg} | -55 ~ +125 | °C |
| 2. | Soldering Temperature | T_{sol} | 260 | °C |

1. AC For 1 Minute, R.H. = 40 ~ 60%

Isolation voltage shall be measured using the following method.

- (1) Short between anode and cathode on the primary side and between collector and emitter on the secondary side.
- (2) The isolation voltage tester with zero-cross circuit shall be used.
- (3) The waveform of applied voltage shall be a sine wave.

2. For 10 Seconds

Photocoupler LTV-8x6 series

4.2 ELECTRICAL OPTICAL CHARACTERISTICS at Ta=25°C

| Parameter | | Symbol | Min. | Typ. | Max. | Unit | Test Condition |
|--------------------------|--------------------------------------|---------------|--------------------|--------------------|------|---------------|--|
| Input | Forward Voltage | V_F | — | 1.2 | 1.4 | V | $I_F=20\text{mA}$ |
| | Reverse Current | I_R | — | — | 10 | μA | $V_R=4\text{V}$ |
| | Terminal Capacitance | C_t | — | 30 | 250 | pF | $V=0, f=1\text{KHz}$ |
| Output | Collector Dark Current | I_{CEO} | — | — | 100 | nA | $V_{CE}=20\text{V}, I_F=0$ |
| | Collector-Emitter Breakdown Voltage | BV_{CEO} | 80 | — | — | V | $I_C=0.1\text{mA}, I_F=0$ |
| | Emitter-Collector Breakdown Voltage | BV_{ECO} | 6 | — | — | V | $I_E=10\mu\text{A}, I_F=0$ |
| TRANSFER CHARACTERISTICS | Collector Current | I_C | 2.5 | — | 30 | mA | $I_F=5\text{mA}, V_{CE}=5\text{V}$ |
| | 1. Current Transfer Ratio | CTR | 50 | — | 600 | % | |
| | Collector-Emitter Saturation Voltage | $V_{CE(sat)}$ | — | 0.1 | 0.2 | V | $I_F=20\text{mA}, I_C=1\text{mA}$ |
| | Isolation Resistance | R_{iso} | 5×10^{10} | 1×10^{11} | — | Ω | DC500V, 40 ~ 60% R.H. |
| | Floating Capacitance | C_f | — | 0.6 | 1 | pF | $V=0, f=1\text{MHz}$ |
| | Cut-off Frequency | f_c | — | 80 | — | kHz | $V_{CE}=5\text{V}, I_C=2\text{mA}$ $R_L=100\Omega, -3\text{dB}$ |
| | Response Time (Rise) | t_r | — | 4 | 18 | μs | $V_{CE}=2\text{V}, I_C=2\text{mA}$ $R_L=100\Omega,$ |
| | Response Time (Fall) | t_f | — | 3 | 18 | μs | |

$$1. \text{CTR} = \frac{I_C}{I_F} \times 100\%$$

Photocoupler LTV-8x6 series

5. RANK TABLE OF CURRENT TRANSFER RATIO

| | CTR Rank | Min | Max | Condition |
|---------|-----------------------|-----|-----|---------------------------------------|
| LTV-816 | L | 50 | 100 | $I_F=5mA, V_{CE}=5V, T_a=25^{\circ}C$ |
| | A | 80 | 160 | |
| | B | 130 | 260 | |
| | C | 200 | 400 | |
| | D | 300 | 600 | |
| | L or A or B or C or D | 50 | 600 | |
| LTV-826 | No Bin | 50 | 600 | |
| | B | 130 | 260 | |
| | C | 200 | 400 | |
| | BC | 130 | 400 | |
| | CD | 200 | 600 | |
| LTV-846 | No Bin | 50 | 600 | |
| | BC | 130 | 400 | |
| | CD | 200 | 600 | |

Photocoupler LTV-8x6 series

6. CHARACTERISTICS CURVES

Fig.1 Forward Current vs. Ambient Temperature

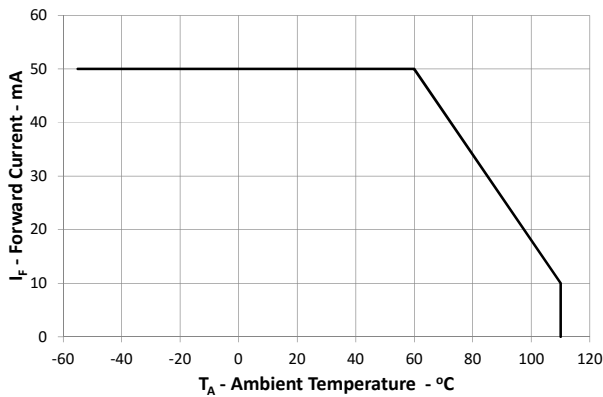

Fig.2 Collector Power Dissipation vs. Ambient Temperature

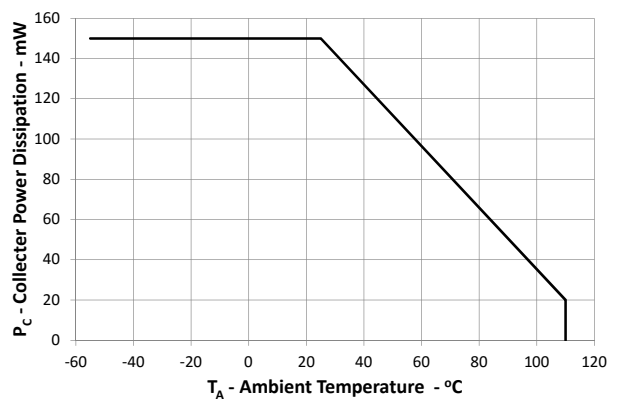

Fig.3 Collector-emitter Saturation Voltage vs. Forward Current

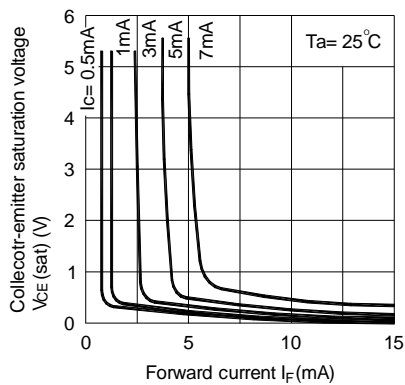

Fig.4 Forward Current vs. Forward Voltage

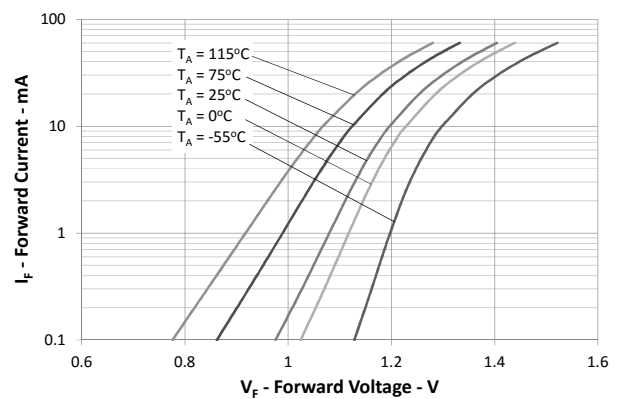

Fig.5 Normalized CTR vs. Forward Current

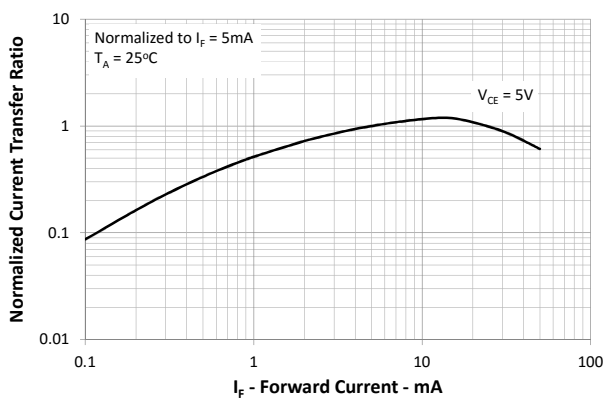
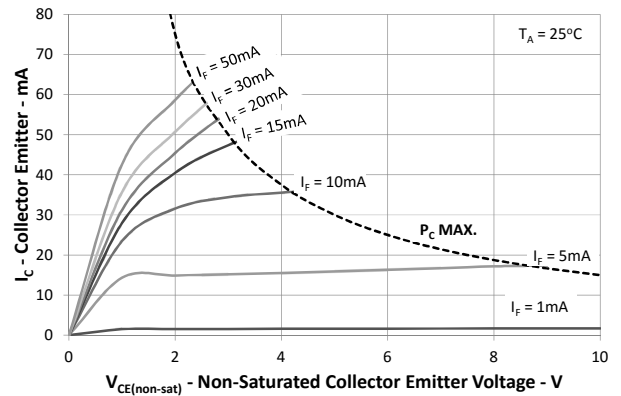

Fig.6 Collector Current vs. Collector-emitter Voltage



Photocoupler LTV-8x6 series

Fig.7 Relative Current Transfer Ratio vs. Ambient Temperature

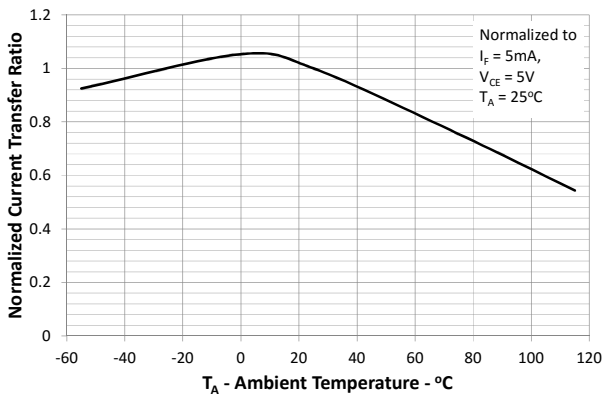

Fig.8 Collector-emitter Saturation Voltage vs. Ambient Temperature

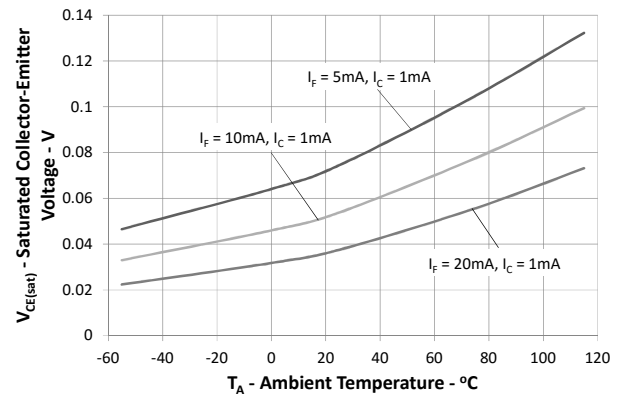

Fig.9 Collector Dark Current vs. Ambient Temperature

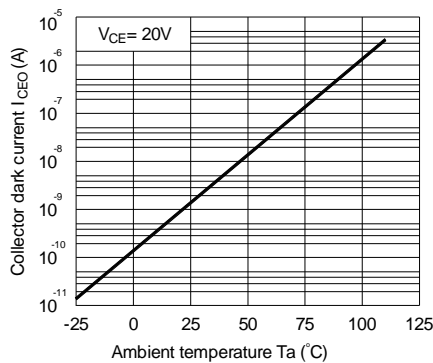

Fig.10 Response Time vs. Load Resistance

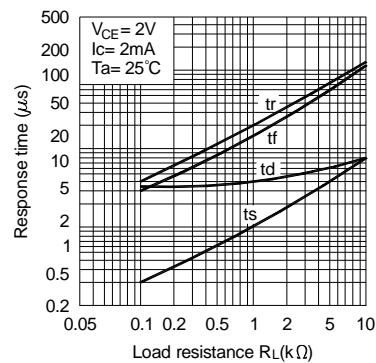
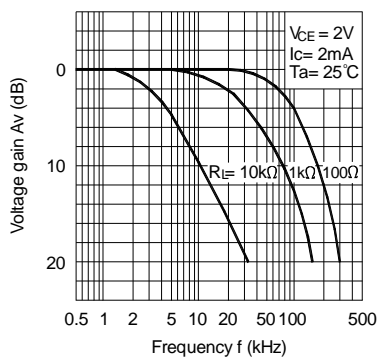
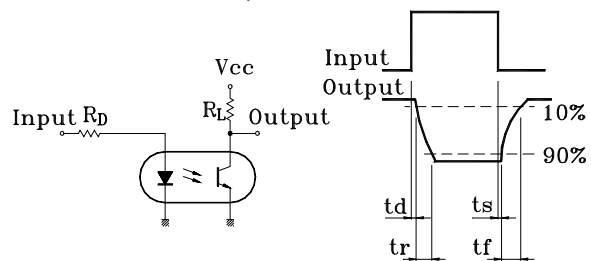

Fig.11 Frequency Response



Test Circuit for Response Time



Test Circuit for Frequency Response

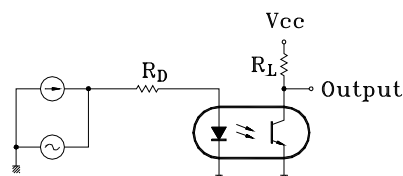

Photocoupler LTV-8x6 series

7. TEMPERATURE PROFILE OF SOLDERING

7.1 IR Reflow soldering (JEDEC-STD-020C compliant)

One time soldering reflow is recommended within the condition of temperature and time profile shown below. Do not solder more than three times.

| Profile item | Conditions |
|----------------------------------|----------------|
| Preheat | |
| - Temperature Min (T_{Smin}) | 150°C |
| - Temperature Max (T_{Smax}) | 200°C |
| - Time (min to max) (ts) | 90±30 sec |
| Soldering zone | |
| - Temperature (T_L) | 217°C |
| - Time (t_L) | 60 sec |
| Peak Temperature (T_P) | 260°C |
| Ramp-up rate | 3°C / sec max. |
| Ramp-down rate | 3~6°C / sec |

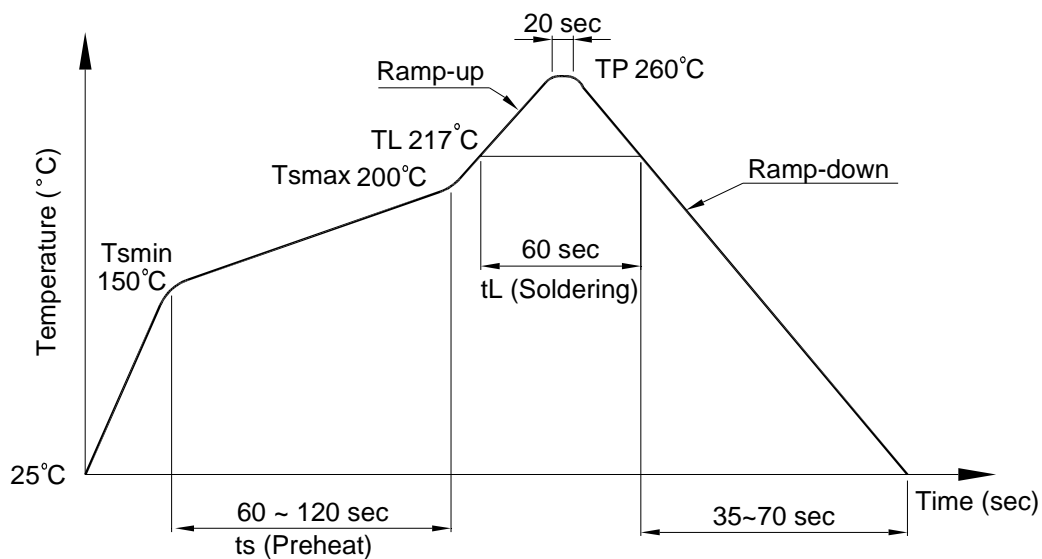

**Photocoupler
LTV-8x6 series**

7.2 Wave soldering (JEDEC22A111 compliant)

One time soldering is recommended within the condition of temperature.

Temperature: $260 \pm 0/-5^{\circ}\text{C}$

Time: 10 sec.

Preheat temperature: 25 to 140°C

Preheat time: 30 to 80 sec.

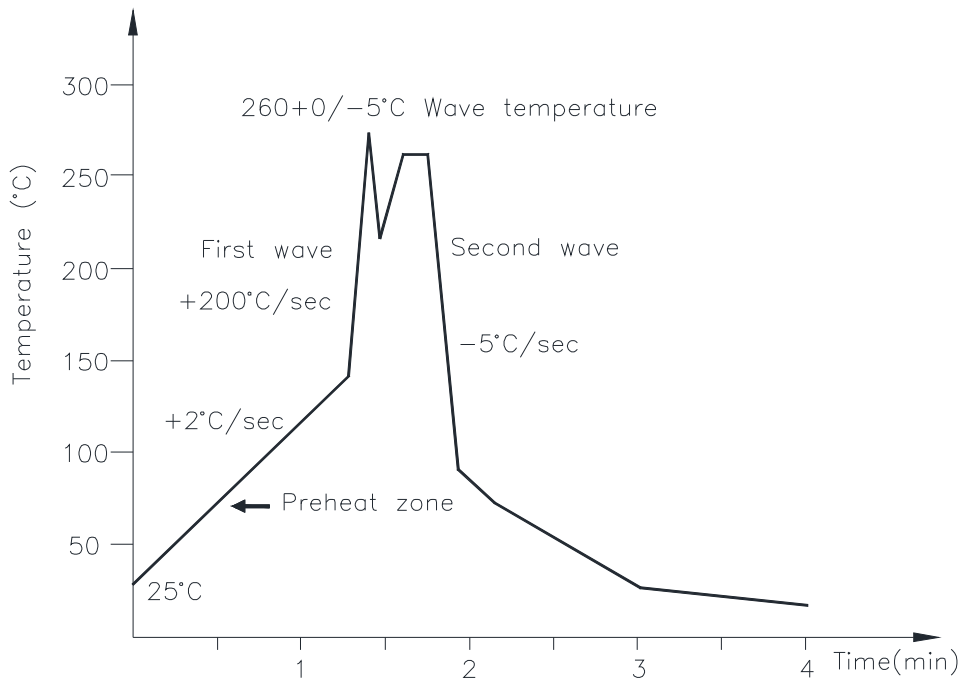

7.3 Hand soldering by soldering iron

Allow single lead soldering in every single process. One time soldering is recommended.

Temperature: $380 \pm 0/-5^{\circ}\text{C}$

Time: 3 sec max.

8. RRECOMMENDED FOOT PRINT PATTERNS (MOUNT PAD)

8.1 4 PIN

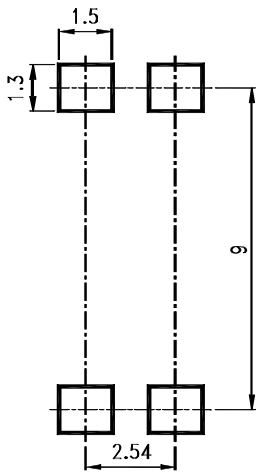

8.2 8 PIN

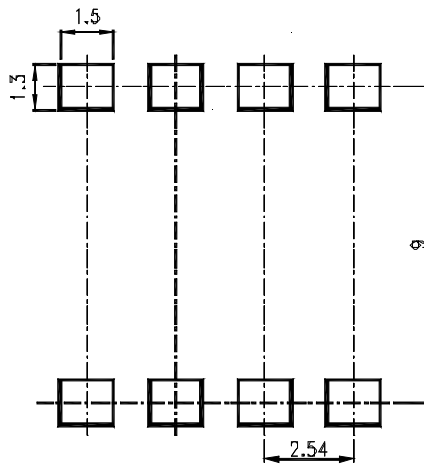

8.3 16 PIN

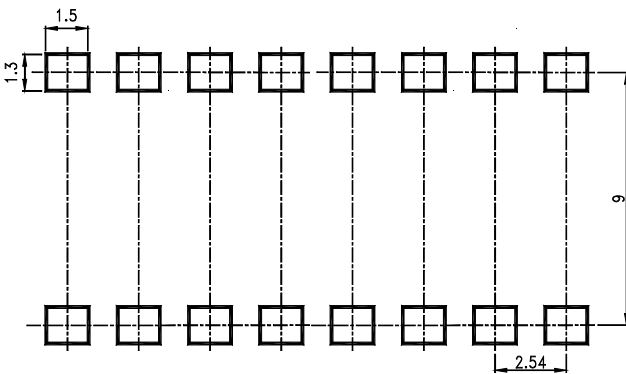

Note :

Dimensions in millimeters.

9. Naming rule

LTV-8X6(1)-(2)-(3)-G

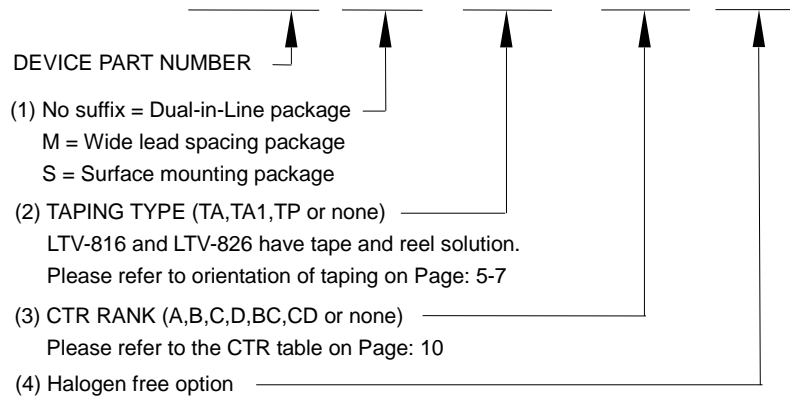

Example : LTV-816S-TA1-A-G

LTV8X6(1)(2)(3)-V-G

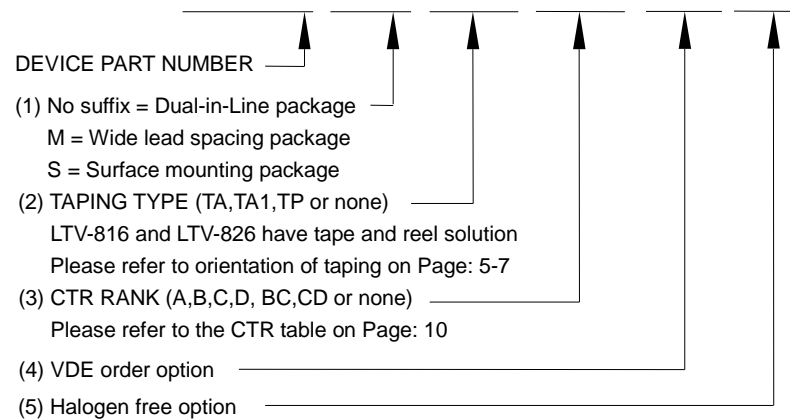

Example : LTV816STA1A-V-G

Photocoupler LTV-8x6 series

10. Notes:

- LiteOn is continually improving the quality, reliability, function or design and LiteOn reserves the right to make changes without further notices.
- The products shown in this publication are designed for the general use in electronic applications such as office automation equipment, communications devices, audio/visual equipment, electrical application and instrumentation.
- For equipment/devices where high reliability or safety is required, such as space applications, nuclear power control equipment, medical equipment, etc, please contact our sales representatives.
- When requiring a device for any "specific" application, please contact our sales in advice.
- If there are any questions about the contents of this publication, please contact us at your convenience.
- The contents described herein are subject to change without prior notice.
- Immerge unit's body in solder paste is not recommended.
- The contents described herein are subject to change without prior notice.
- Immerge unit's body in solder paste is not recommended.

Mouser Electronics

Authorized Distributor

Click to View Pricing, Inventory, Delivery & Lifecycle Information:

[Lite-On:](#)

[LTV-816S](#) [LTV-826S](#) [LTV-846](#) [LTV-826](#) [LTV-816](#) [LTV-846S](#) [LTV-816M](#) [LTV-816S-TA](#) [LTV-816S-TA1](#) [LTV-826S-](#)
[TA](#) [LTV-826S-TA1](#) [LTV 816S-TA1-A-V](#)