

**SURFACE MOUNT SCHOTTKY BARRIER RECTIFIER**
**Features**

- Low Forward Voltage Drop
- Guard Ring Construction for Transient Protection
- High Conductance
- **Lead, Halogen and Antimony Free, RoHS Compliant "Green" Device (Notes 3 and 4)**
- **Qualified to AEC-Q101 Standards for High Reliability**

**Mechanical Data**

- Case: SOD-323
- Case Material: Molded Plastic. UL Flammability Classification Rating 94V-0
- Moisture Sensitivity: Level 1 per J-STD-020D
- Lead Free Plating (Matte Tin Finish annealed over Alloy 42 leadframe). Solderable per MIL-STD-202, Method 208
- Polarity: Cathode Band
- Marking Information: See Page 3
- Ordering Information: See Page 3
- Weight: 0.004 grams (approximate)



Top View

**Maximum Ratings** @T<sub>A</sub> = 25°C unless otherwise specified

Single phase, half wave, 60Hz, resistive or inductive load.  
For capacitance load, derate current by 20%.

Characteristic	Symbol	Value	Unit
Peak Repetitive Reverse Voltage	V <sub>RRM</sub>	30	V
Working Peak Reverse Voltage	V <sub>RWM</sub>		
DC Blocking Voltage	V <sub>R</sub>		
RMS Reverse Voltage	V <sub>R(RMS)</sub>	21	V
Average Rectified Output Current (See Figure 1)	I <sub>O</sub>	0.5	A
Peak Repetitive Forward Current tp = 8.3ms, half sine-wave	I <sub>FRM</sub>	3.5	A
Non-Repetitive Peak Forward Surge Current 8.3ms single half sine-wave superimposed on rated load	I <sub>FSM</sub>	2	A

**Thermal Characteristics**

Characteristic	Symbol	Value	Unit
Power Dissipation (Note 1)	P <sub>D</sub>	235	mW
Typical Thermal Resistance Junction to Ambient (Note 1)	R <sub>θJA</sub>	426	°C/W
Operating and Storage Temperature Range	T <sub>J</sub> , T <sub>STG</sub>	-40 to +125	°C

**Electrical Characteristics** @T<sub>A</sub> = 25°C unless otherwise specified

Characteristic	Symbol	Min	Typ	Max	Unit	Test Conditions
Reverse Breakdown Voltage (Note 2)	V <sub>(BR)R</sub>	30	—	—	V	I <sub>R</sub> = 500μA
Forward Voltage Drop	V <sub>F</sub>	—	—	0.36 0.45	V	I <sub>F</sub> = 0.1A I <sub>F</sub> = 0.5A
Leakage Current (Note 2)	I <sub>R</sub>	—	—	80 100 500	μA	V <sub>R</sub> = 15V V <sub>R</sub> = 20V V <sub>R</sub> = 30V
Total Capacitance	C <sub>T</sub>	—	58	—	pF	f = 1MHz, V <sub>R</sub> = 0V DC

- Notes:
1. Part mounted on FR-4 PC board with recommended pad layout, which can be found on our website at <http://www.diodes.com/datasheets/ap02001.pdf>.
  2. Short duration pulse test used to minimize self-heating effect.
  3. No purposefully added lead. Halogen and Antimony Free.
  4. Product manufactured with Data Code V9 (week 33, 2008) and newer are built with Green Molding Compound. Product manufactured prior to Date Code V9 are built with Non-Green Molding Compound and may contain Halogens or Sb<sub>2</sub>O<sub>3</sub> Fire Retardants.

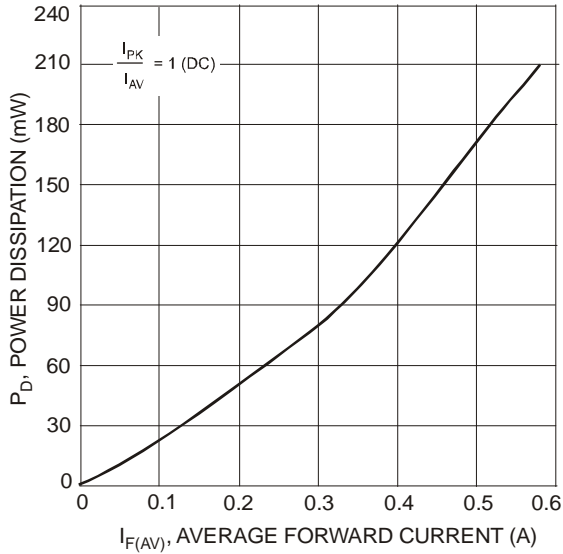

Fig. 1 Forward Power Dissipation

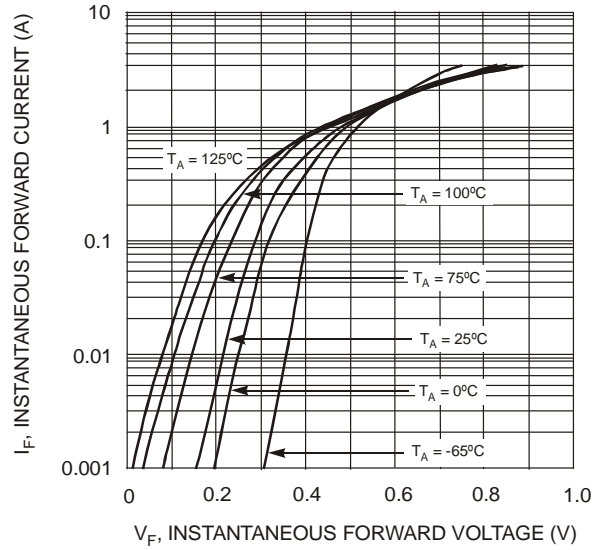

Fig. 2 Typical Forward Characteristics

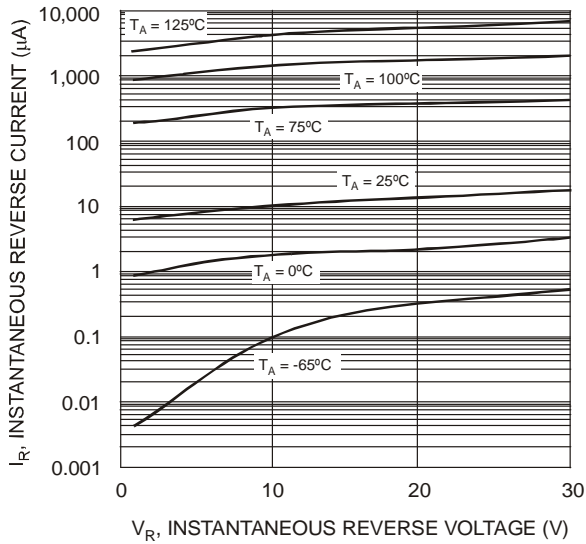

Fig. 3 Typical Reverse Characteristics

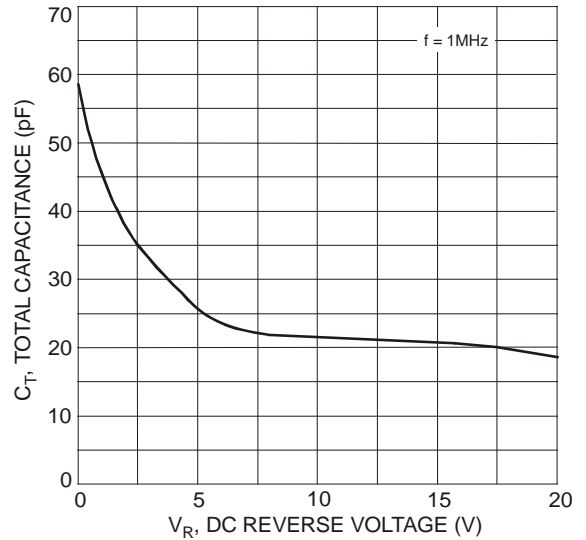

Fig. 4 Total Capacitance vs. Reverse Voltage

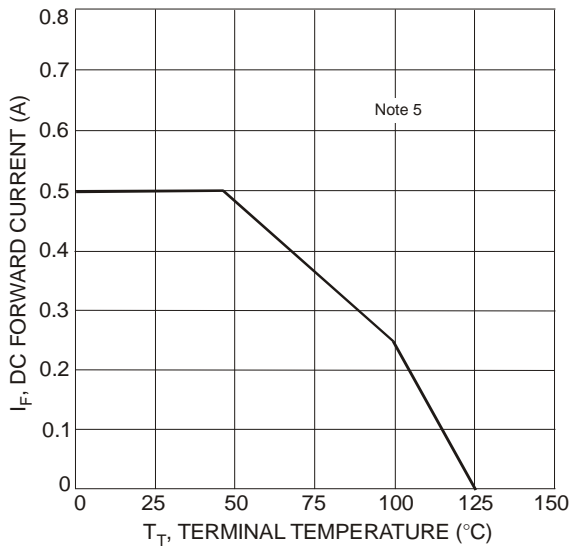

Fig. 5 Forward Current Derating Curve

### Ordering Information (Note 6)

Part Number	Case	Packaging
B0530WS-7-F	SOD-323	3000/Tape & Reel

Notes: 6. For packaging details, go to our website at <http://www.diodes.com/datasheets/ap02007.pdf>.

### Marking Information

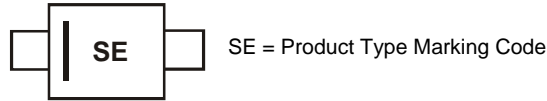

### Package Outline Dimensions

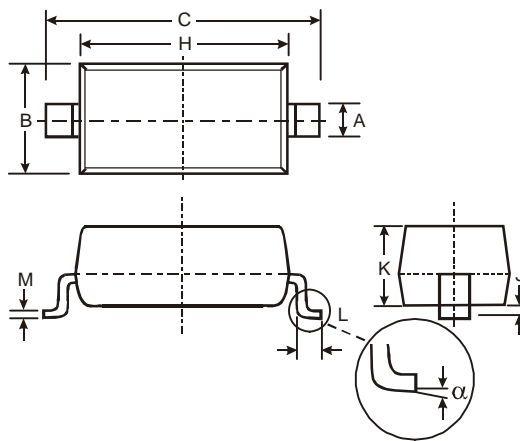

SOD-323		
Dim	Min	Max
A	0.25	0.35
B	1.20	1.40
C	2.30	2.70
H	1.60	1.80
J	0.00	0.10
K	1.0	1.1
L	0.20	0.40
M	0.10	0.15
$\alpha$	0°	8°
All Dimensions in mm		

### Suggested Pad Layout

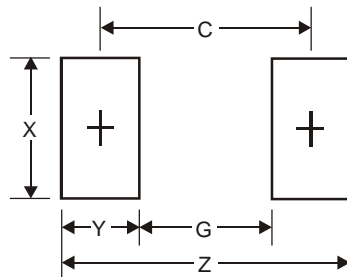

Dimensions	Value (in mm)
Z	3.75
G	1.05
X	0.65
Y	1.35
C	2.40

#### IMPORTANT NOTICE

Diodes Incorporated and its subsidiaries reserve the right to make modifications, enhancements, improvements, corrections or other changes without further notice to any product herein. Diodes Incorporated does not assume any liability arising out of the application or use of any product described herein; neither does it convey any license under its patent rights, nor the rights of others. The user of products in such applications shall assume all risks of such use and will agree to hold Diodes Incorporated and all the companies whose products are represented on our website, harmless against all damages.

#### LIFE SUPPORT

Diodes Incorporated products are not authorized for use as critical components in life support devices or systems without the expressed written approval of the President of Diodes Incorporated.