

SPECIFICATION

Customer : QUARTZ-1

Applied To :

Product Name : Mini strobe siren

Model Name : KP-G120R-24-195

Drawing No. : KTC195

Compliance with ROHS(本品符合ROHS指令)

Signature of Approval

--

Signature of KEPO

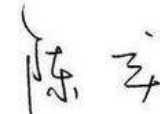
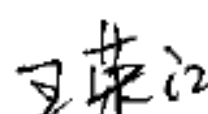
Approved by	Checked by	Issued by	Date
			

宁波凯普电子有限公司

Ningbo Kepo Electronics Co.,Ltd.



宁波东钱湖镇东钱湖工业区宝源路 25 号

TEL:+86-574-88370330 FAX:+86-574-88370329

No.25 Baoyuan road Dongqian Lake, Industry Area, Dongqian town,Ningbo City,
China(Post Code:315121)

Sales@chinaacoustic.com

www.chinaacoustic.com

Specification for Electronic Siren	Page	3/8
	Revision No.	1.0
	Drawing No.	KTC195

Model No. : KP-G120R-24-195

1. Scope

This product specification is applied to the siren used for sounder in alarm systems. Please contact us when using this product for any other applications than described in the above.

本规格书适用于报警器，通常它用在系统中做报警或提示，如果将该产品用于其它领域，请与我们联系。

2. General

2.1 Out-Diameter : 122x73 mm

外径: 122x73 mm

2.2 Height : 50 mm

高度: 50 mm

2.3 Weight : 115 gr.

重量: 115克

2.4 Operating Temperature range:

-20~+60°C without loss of function

工作温度: -20~+60°C

2.5 Store Temperature range:

-30~+70°C without loss of function

储藏温度: -30~+70°C

3. Electrical and Acoustic Characteristics.

Test condition : 15 ~ 35 °C, 25% ~ 85% RH, 860~1060 mbar

测试条件: 15~35 °C, 25%~85%RH, 860~1060mbar

	Items 项目	Specification 规格
1	Rated Voltage 额定电压	24VDC
2	Operating Voltage 工作电压	18-27VDC
3	Max. Rated Current 额定电流	100mA/24VDC
4	Sound Pressure Level 额定声压	108± 2dB/24VDC/30cm
5	Flashes/Min 闪光次	150 times
6	Tone Nature 音调	Siren
7	Case Material 壳体材质	PC/ABS
8	Color 颜色	Red/White

Specification for Electronic Siren	Page	4/8
	Revision No.	1.0
	Drawing No.	KTC195

Model No. : KP-G120R-24-195

4. Reliability Test

After test(1~6item), the electronic siren SOUND METER OR EQUIVALENT difference shall be within $\pm 10\text{dB}$, and the appearance not exist any change to be harmful to normal operation(e.g.cracks,rusts,damages and especially distortion).

在1-6项试验后，报警器的声压变化值在 $\pm 10\text{dB}$ 之内，外观无变化（例如：开裂、生锈、损伤、变形等现象）。

	Item	Specification
1	High Temperature Test 高温试验	After being woked in a chamber with $+60\pm 2\text{ }^\circ\text{C}$ for 2h and then being placed in natural condition for 2h, sounder shall be measured. 将产品置于 $+60\pm 2\text{ }^\circ\text{C}$ 试验箱中，先工作 2小时，然后在正常大气压条件下恢复2小时后，进行测量
2	Low Temperature Test 低温试验	First being worked in a chamber with $-20\pm 2\text{ }^\circ\text{C}$ for 2h and then being placed in a chamber with $-20\pm 2\text{ }^\circ\text{C}$ for 16h, finally being placed in natural condtion for 2h, sounder shall be measured. 将产品置于 $-20\pm 2\text{ }^\circ\text{C}$ 试验箱中，先工作 2小时，再放置16小时，然后在正常大气压条件下恢复2小时后，进行测量
3	Humidity Test 潮湿试验	After being placed in a chamber with 90 to 95%R.H. at $+40\pm 2\text{ }^\circ\text{C}$ for 2 h and then being placed in natural condition for 2h , sounder shall be measured. 将产品置于湿度为 90-95%R.H, 温度为 $40\pm 2\text{ }^\circ\text{C}$ 试验箱中 2小时，然后在正常大气压条件下恢复2小时后，进行测量
4	Shock 耐冲击性	Under acceleration of peak $100\text{m/s}^2(10\text{g})$ & half sine wave pulse (pulse time is 16ms)condition.run into product 1000 times continuously. 峰值加速度 $100\text{m/S}^2(10\text{g})$,脉冲持续时间为16ms的半正弦波脉冲对试样连续碰撞1000次，测试报警器.

Specification for Electronic Siren	Page	5/8
	Revision No.	1.0
Model No. : KP-G120R-24-195	Drawing No.	KTC195

4. Reliability Test

	Item	Specification
5	Drop Test 跌落试验	Siren packed in the carton are dropped in six direction from the height of 50cm to the concrete floor. 跌落高度50cm,6个不同方向整箱跌落到水泥地, 试验后进行测量.
6	Vibration Resistance 振动试验	Siren shall be measured after being applied vibration of amplitude of 1.5mm with 10to 30Hz band of vibration frequency to each of 3 perpendicular directions for 2 hour. 振幅为1.5mm, 频率为10-30Hz, 三个不同轴方向各振动2小时, 试验后进行测量.

5. Measurement Block Diagram

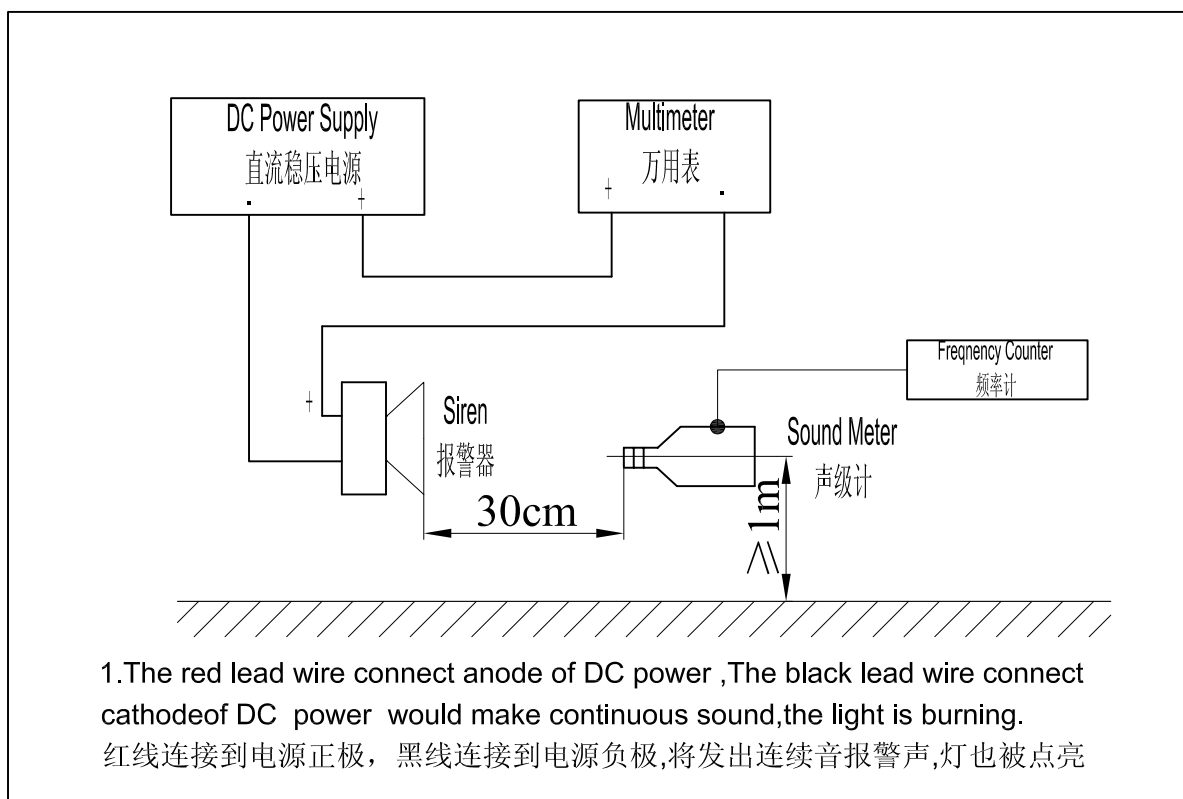

Specification for Electronic Siren		Page	6/8
		Revision No.	1.0
Model No. :	KP-G120R-24-195	Drawing No.	KTC195

7. Dimensions

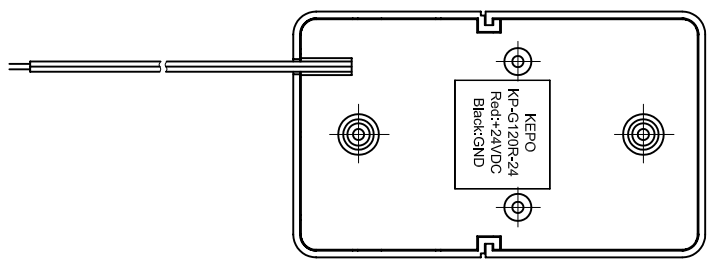
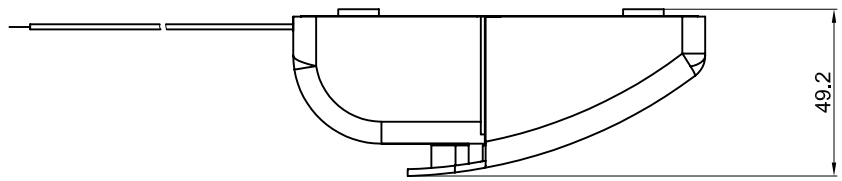
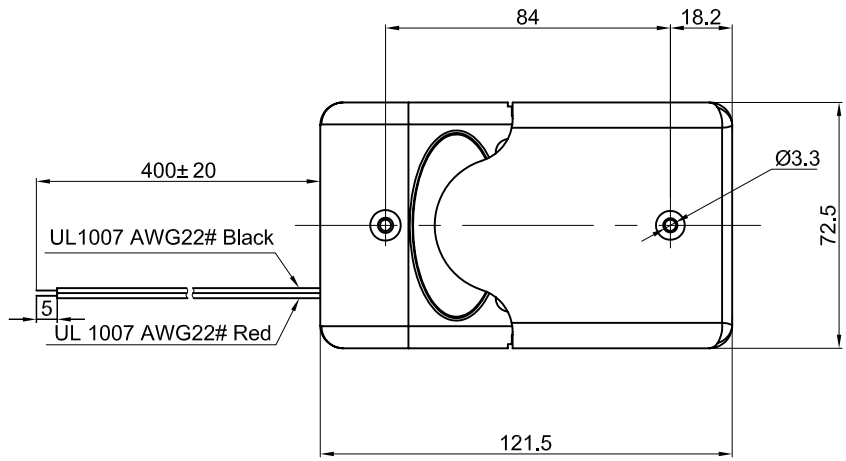

FIRST ANGLE PROJECTION

UNIT : mm
Tolerance : ±0.5