



Pushing Performance

# HARTING Han-Yellock®



## Transforming customer wishes into concrete solutions



The HARTING Technology Group is skilled in the fields of electrical, electronic and optical connection, transmission and networking, as well as in manufacturing, mechatronics and software creation.

The Group uses these skills to develop customized solutions and products such as connectors for energy and data transmission applications including, for example, mechanical engineering, rail technology, wind energy plants, factory automation and the telecommunications sector. In addition, HARTING also produces electromagnetic components for the automobile industry and offers solutions in the field of Enclosures and Shop Systems.

The HARTING Group currently comprises 32 subsidiary companies and worldwide distributors employing a total of approximately 3,000 staff.



HARTING Subsidiary company



HARTING Representatives



### WE ASPIRE TO TOP PERFORMANCE.

Connectors ensure functionality. As core elements of electrical and optical wiring, connection and infrastructure technologies, they are essential in enabling the modular construction of devices, machines and systems across a very wide range of industrial applications. Their reliability is a crucial factor guaranteeing smooth functioning in the manufacturing area, in telecommunications, applications in medical technology – in fact, connectors are at work in virtually every conceivable application area. Thanks to the consistent further development of our technologies, customers enjoy investment security and benefit from durable, long term functionality.

### ALWAYS AT HAND, WHEREVER OUR CUSTOMERS MAY BE.

Increasing industrialization is creating growing markets characterized by widely diverging demands and requirements. The search for perfection, increasingly efficient processes and reliable technologies is a common factor in all sectors across the globe. HARTING is providing these technologies – in Europe, America and Asia. The HARTING professionals at our international subsidiaries engage in close, partnership based interaction with our customers, right from the very early product development phases, in order to realize customer demands and requirements in the best possible manner.

Our people on location form the interface to the centrally coordinated development and production departments. In this way, our customers can rely on consistently high, superior product quality – worldwide.

### OUR CLAIM: PUSHING PERFORMANCE.

HARTING provides more than optimally attuned components. In order to serve our customers with the best possible solutions, HARTING is able to contribute a great deal more and play a closely integrative role in the value creation process.

From ready assembled cables through to control racks or ready-to-go control desks: Our aim is to generate the maximum benefits for our customers – without compromise!

### QUALITY CREATES RELIABILITY – AND WARRANTS TRUST.

The HARTING brand stands for superior quality and reliability – worldwide. The standards we set are the result of consistent, stringent quality management that is subject to regular certifications and audits.

EN ISO 9001, the EU Eco-Audit and ISO 14001:2004 are key elements here. We take a proactive stance to new requirements, which is why HARTING ranks among the first companies worldwide to have obtained the new IRIS quality certificate for rail vehicles.

## HARTING TECHNOLOGY CREATES ADDED VALUE FOR CUSTOMERS.

Technologies by HARTING are at work worldwide. HARTING's presence stands for smoothly functioning systems, powered by intelligent connectors, smart infrastructure solutions and mature network systems. In the course of many years of close, trust-based cooperation with its customers, the HARTING Technology Group has advanced to one of the worldwide leading specialists for connector technology. Extending beyond the basic functionalities demanded, we offer individual customers specific and innovative solutions. These tailored solutions deliver sustained effects, provide investment security and enable customers to achieve strong added value.

## OPTING FOR HARTING OPENS UP AN INNOVATIVE, COMPLEX WORLD OF CONCEPTS AND IDEAS.

In order to develop connectivity and network solutions serving an exceptionally wide range of connector applications and task scopes in a professional and cost optimized manner, HARTING not only

commands the full array of conventional tools and basic technologies. Over and beyond these capabilities, HARTING is constantly harnessing and refining its broad base of knowledge and experience to create new solutions that ensure continuity at the same time. In securing this know-how lead, HARTING draws on a wealth of sources from both in-house research and the world of applications alike.

Salient examples of these sources of innovative knowledge include microstructure technologies, 3D design and construction technology, as well as high temperature or ultrahigh frequency applications that are finding use in telecommunications or automation networks, in the automotive industry, or in industrial sensor and actuator applications, RFID and wireless technologies, in addition to packaging and housing made of plastics, aluminum or stainless steel.

## HARTING SOLUTIONS EXTEND ACROSS TECHNOLOGY BOUNDARIES.

Drawing on the comprehensive resources of the group's technology pool, HARTING devises

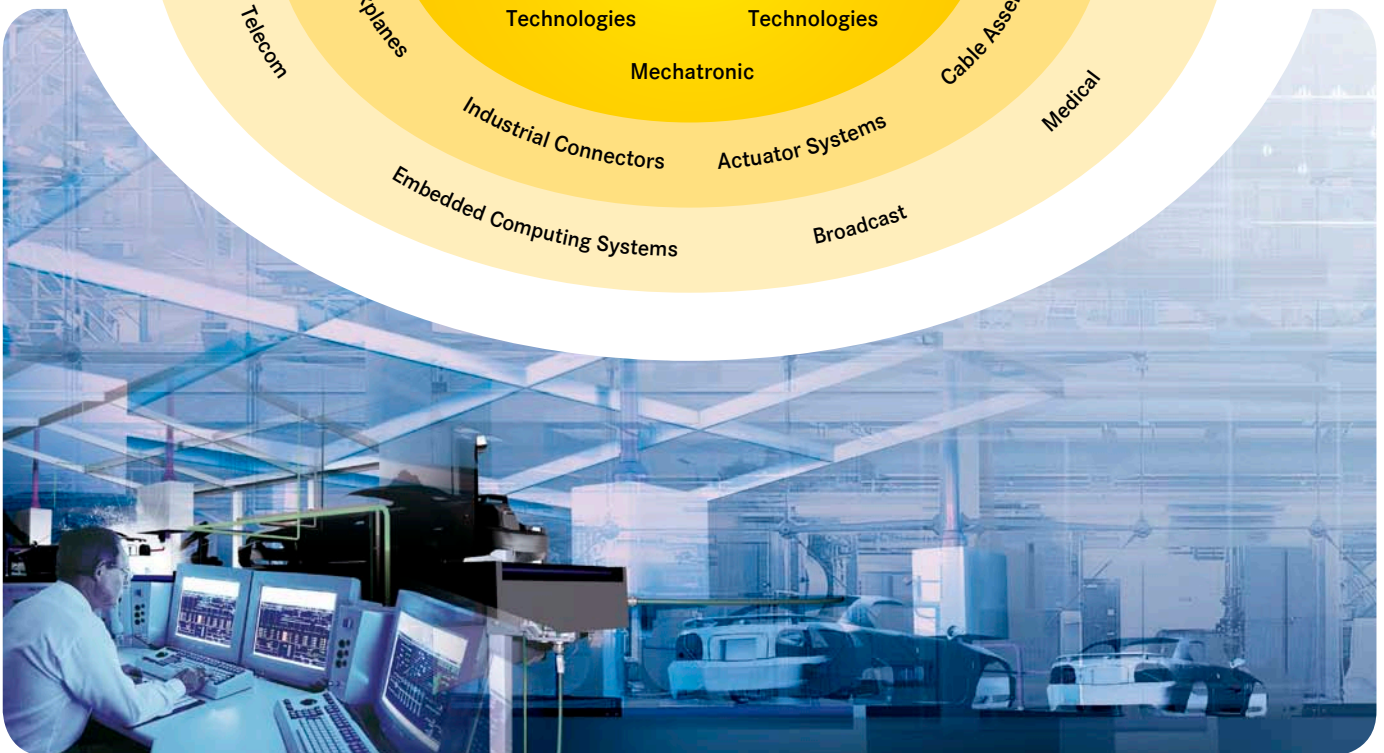
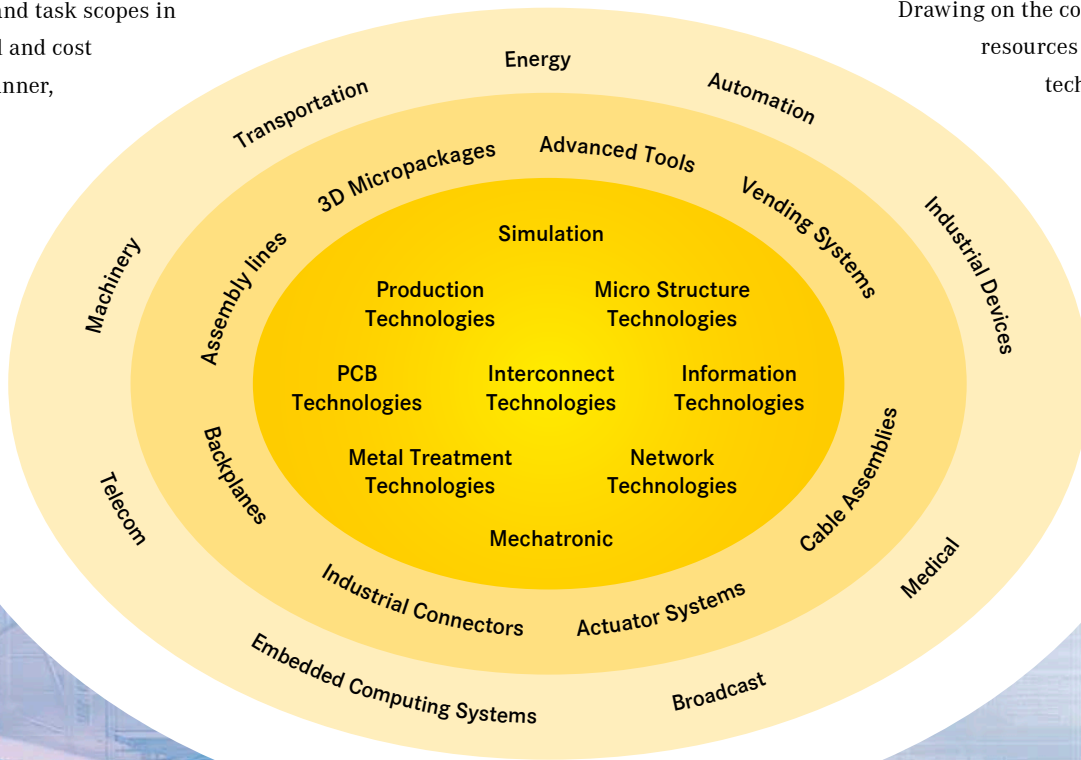

practical solutions for its customers. Whether this involves industrial networks for manufacturing automation, or hybrid interface solutions for wireless telecommunication infrastructures, 3D circuit carriers with microstructures, or cable assemblies for high-temperature applications in the automotive industry - HARTING technologies offer far more than components, and represent mature, comprehensive solutions attuned to individual customer requirements and wishes. The range covers ready-to-use cable configurations, completely assembled backplanes and board system carriers, as well as fully wired and tested control panels.

In order to ensure the future proof design of RF- and EMC-compatible interface solutions, the central HARTING laboratory (certified to EN 45001) provides simulation tools, as well as experimental, testing and diagnostics facilities all the way through to scanning electron microscopes. In the selection of materials and processes, lifecycle and environmental aspects play a key role, in addition to product and process capability considerations.

#### **HARTING KNOWLEDGE IS PRACTICAL KNOW-HOW GENERATING SYNERGY EFFECTS.**

HARTING commands decades of experience with regard to the applications conditions of connectors in telecommunications, computer and network technologies and medical technologies, as well as industrial automation technologies, such as the mechanical engineering and plant engineering areas, in addition to the power generation industry or the transportation sector. HARTING is highly conversant with the specific application areas in all of these technology fields.

The key focus is on applications in every solution approach. In this context, uncompromising, superior quality is our hallmark. Every new solution found will invariably flow back into the HARTING technology pool, thereby enriching our resources. And every new solution we go on to create will draw on this wealth of resources in order to optimize each and every individual solution. In this way, HARTING is synergy in action.

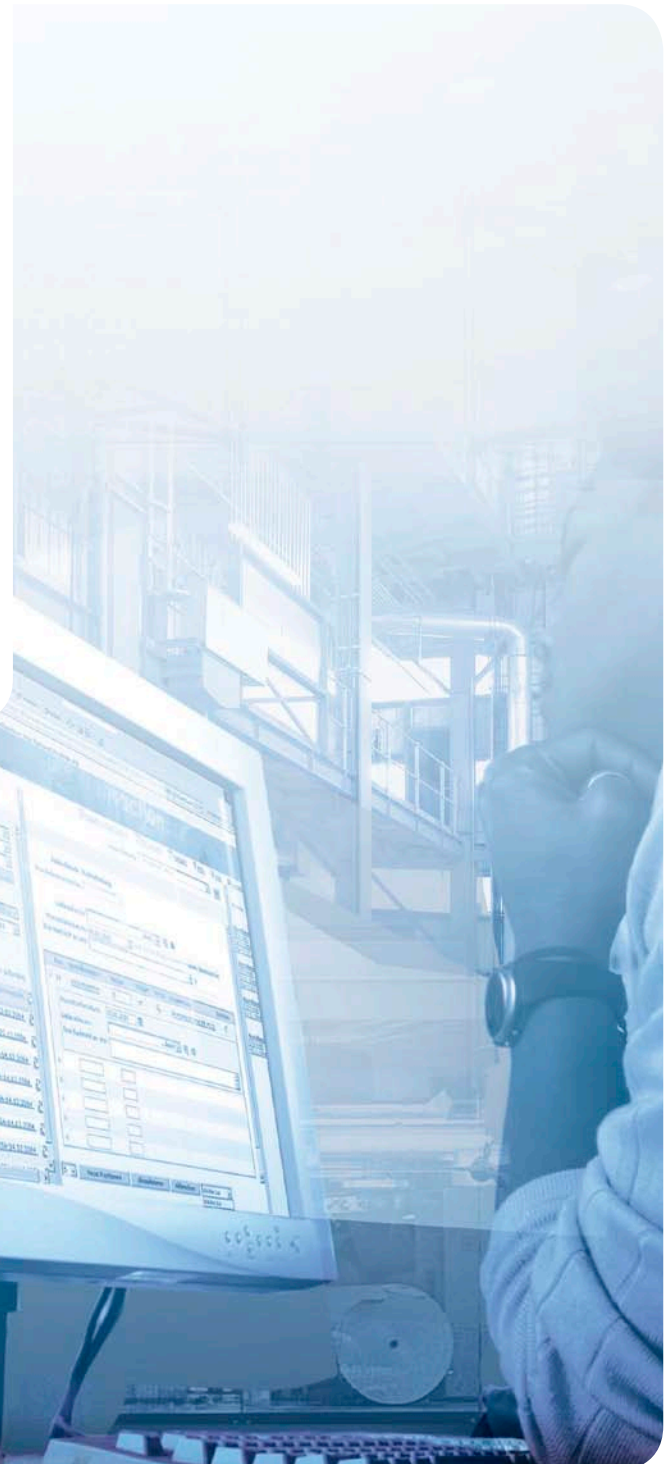

## Field of application

HARTING Industrial Connectors are applicable in a wide variety of electronic and electrical applications. The degree of protection of all hoods and housings is in accordance with International Standard IEC 60 529, EN 60 529.

- Power Utilities
- Robotics
- Chemical Plants
- Machine Tool Controls
- Injection Moulding
- Industrial Instrumentation
- Conveyor Equipment
- Cabinet builders
- and many more.



Certified according to EN ISO 9001 in design/development, production, installation and servicing

## Specifications:

DIN EN 60 664-1  
Table concerning clearance and creepage distances

DIN EN 61 984  
Connectors and plug devices

## Note:

Connectors should not be coupled and decoupled under electrical load. Connectors of the same or different series being mounted side by side may be protected against incorrect mating by the use of coding options.

## General information:

It is the user's responsibility to check whether the components illustrated in this catalogue comply with different regulations from those stated in special fields of application which we are unable to foresee.

We reserve the right to modify designs in order to improve quality, keep pace with technological advancement or meet particular requirements in production.

No part of this catalogue may be reproduced in any form (print, photocopy, microfilm or any other process) or processed, duplicated or distributed by means of electronic systems without the prior written consent of HARTING Electric GmbH & Co. KG, Espelkamp. We are bound by the German version only.



## Description of the Han-Yellock® system

### The Han-Yellock® - a special Han® connector

Han-Yellock® is a new product series which retains the core functionality but differs significantly from current size and shape formats. The approach of this series makes many new functions possible, for example:

- ❑ An internal, latched locking mechanism on the hood
- ❑ Multiplies the potentials in the connector with Han-Yellock® modules
- ❑ Usage of Han-Modular® modules with adapter frames
- ❑ Insulators can snap into the front or back walls of the housing
- ❑ Protected Earth contact (PE) in crimp or Quick Lock termination

These new technical features encourage sustained and effective improvements:

When purchasing products –

- ❑ Less article numbers and less inventory,

When planning for the electrical and mechanical layout –

- ❑ Less wiring work within a machine,

During the work flow –

- ❑ Less steps in the work flow and quicker assembly,

And during the after-sales stage –

- ❑ Reduced down times because of the latched locking mechanism and maintenance-friendly design

Thus, the Han-Yellock® offers improved functionality in the form of increased variability, multiplied potential, simplified handling, reduced incidence of errors and maximized safety.

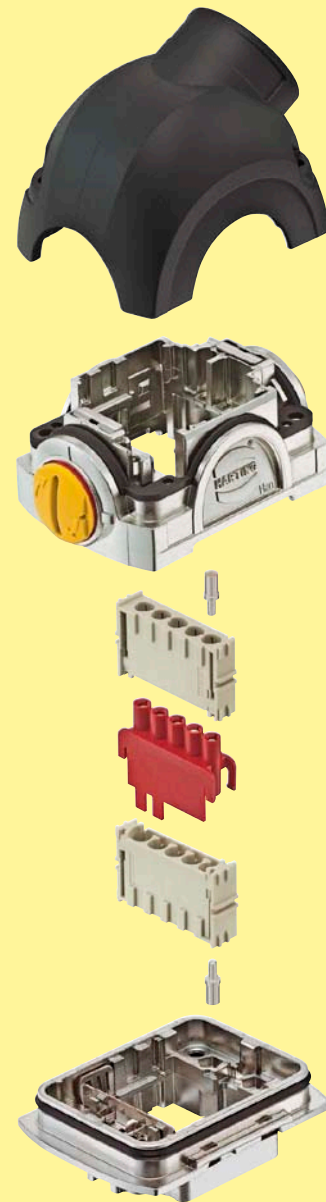

Assembly details

### Design overview

The Han-Yellock® interface consists of a housing, bulkhead mounting, on the housing side and a carrier hood with cover on the cable side.

Han-Yellock® offers the following features when assembling components:

- ❑ Han-Yellock® modules require only male crimp contacts.
- ❑ The PE is contacted on the housing; it can be connected with crimp and/or Quick Lock contacts.
- ❑ The Han-Yellock® hoods/housing are not plug-compatible with all other Han® hood/housing series.

The Han-Yellock® system can be used with a variety of insulators and contact inserts in order to establish an interface.



## The Locking

The locking ability is a key function of the Han-Yellock®. The function makes connections and disconnections safe, simple and quick – even under harsh industrial conditions.

Main advantages include:

- ❑ Easy handling
- ❑ Resistance to vibrations and shock
- ❑ Protected against accidental opening
- ❑ Compact, space-saving design

Han-Yellock® features a patented internal locking mechanism. The locking takes place as the cable and device sides are simply joined together. A red ring around the perimeter of the push button will be visible if the housing halves do not snap together properly. This ring disappears as soon as the internally protected stainless steel springs snap into place.

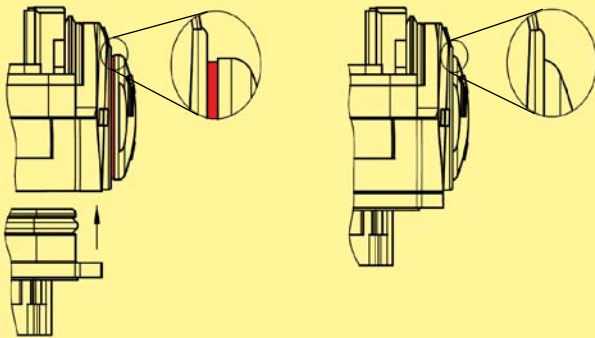

unlocked

locked

This press-button locking also features an integrated blocking function. The locking mechanism can be locked by rotating the button 90°. It is then no longer possible to open the connector.

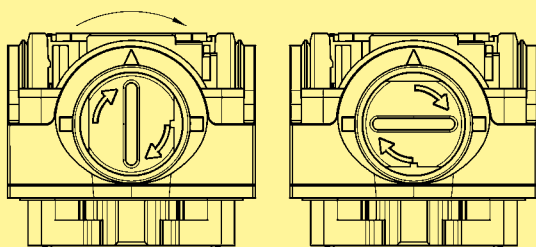

„open“

„blocked“

The press button can be set back to its visually open position only after the button is turned back 90°. It is then possible to release the two housing halves by pressing the snap-in button.

This feature provides an elegant mechanism for preventing an accidental opening of the connector – and no additional components are needed for it.

## Han-Yellock® modules

This new product series enables an improved approach and strategy for electrical planning and procurement.

For assembling the Han-Yellock® connector only male crimp contacts are needed. The conduct between the two male contacts is made by multipliers.

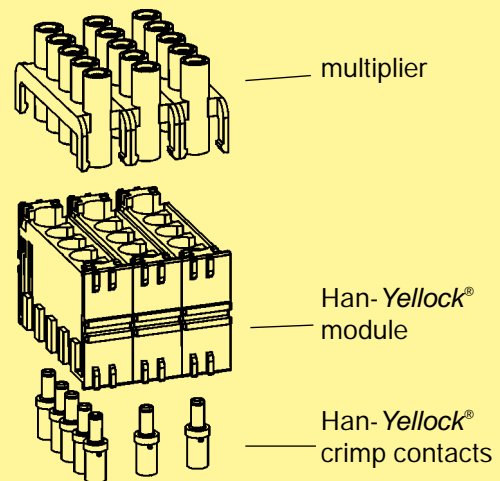

This concept allows a 1:1 wire to wire arrangement and in addition the use of bridges. Two to five contacts can be arranged.

It does not matter if the bridge attachment is inserted on the cable side or the housing side of the connector.

In the past, terminals blocks have been responsible for the function of multiplying potentials. But now this function has been integrated into the connector for a quick, compact and easy-to-service solution.

Inserting the module into the hoods/housing

- ❑ The Han-Yellock® module should only be inserted into the „A“ plug-in position in the metal clamp.

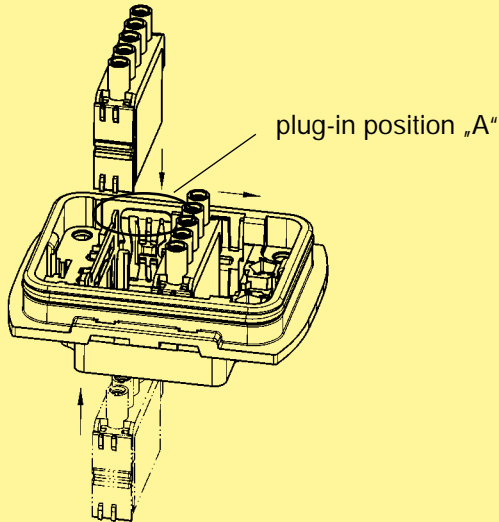

- ❑ The illustration shows the orientation of the module (see arrangement of contacts 1 ... 5).

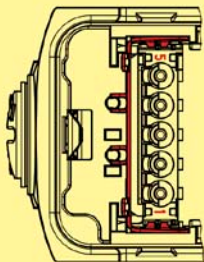

Carrier hood, mating side

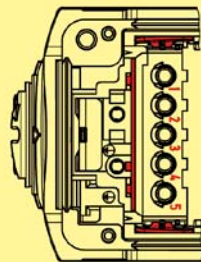

Carrier hood, connection side

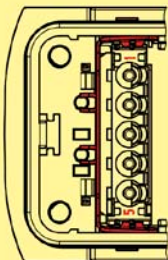

Housing, bulkhead mounting, mating side

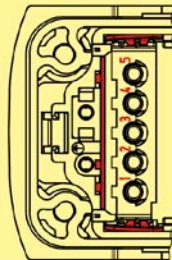

Housing, bulkhead mounting, connection side

- ❑ A distinct click can be heard when the module snaps into position. It is then pushed along the rail to its final position.

The plug-in slots must always be completely filled.

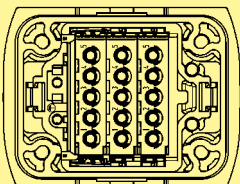

Disassembling the Han-Yellock® module

- ❑ The removal tool (part no. 11 99 000 0001) is required to take out the module.
- ❑ The following illustration shows how to insert the removal tool into the metal clamp. The tool should then be pressed down until it reaches the end stop.
- ❑ The tool is then pulled back and the module comes out of the housing.
- ❑ The removal can be made from the connection side as well as from the mating side.

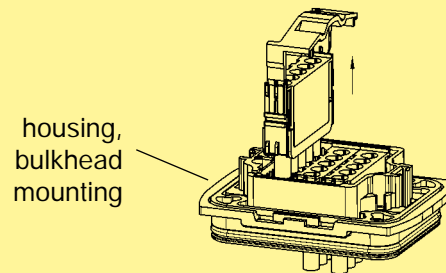
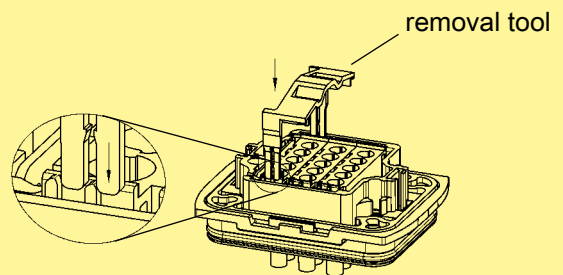

- ❑ The process is identical for both housings, bulkhead mounting, and carrier hoods.
- ❑ The removal tool can be stored on the carrier hood:

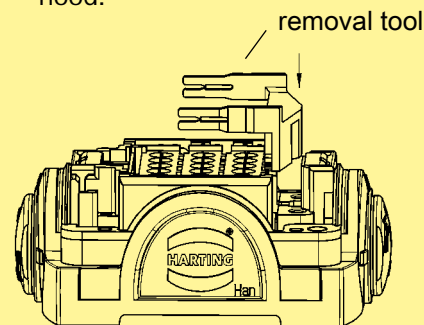

carrier hood

## Han-Yellock® adapter frame

Han-Modular® series interfaces can be established using the Han-Yellock® adapter frame. The connection is based on a male/female contact arrangement.

Inserting the adapter frame in the housing:

- ❑ The adapter frame can be snapped into the housing, bulkhead mounting, on the termination side and the mating side (refer to the illustration).
- ❑ The lateral plastic tabs („B“) are pressed into the metal clamps on the housing.
- ❑ The adapter frame then snaps in with a distinctly audible click.

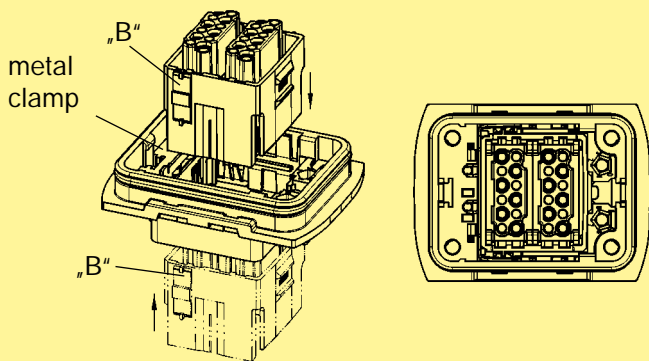

Removal the adapter frame:

- ❑ The removal tool part no. 11 99 000 0001 is required for disassembly.
- ❑ The removal tool is inserted into the metal clamp and pressed down as shown in the following illustration. A screwdriver need also be placed into the notch in the housing.
- ❑ The removal tool should then be pulled outwards to remove the adapter frame from the housing.
- ❑ The removal can be made from the termination side as well as from the mating side.
- ❑ The process is identical for both housings, bulkhead mounting, and carrier hoods.

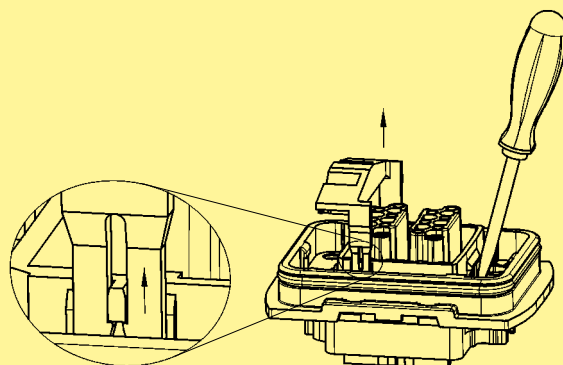
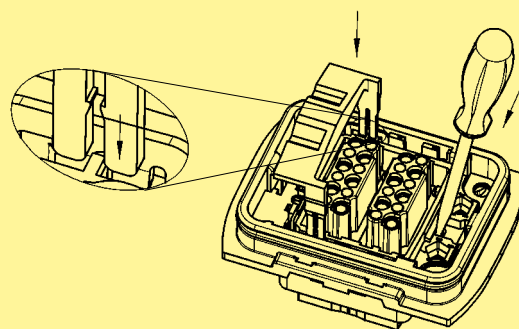

## Han-Yellock® Protection covers

### Protection cover function

To protect the insert against dust and water it is possible to use a Han-Yellock® protection cover.

The protection cover comes with a metal bearing pedestal and can be installed during initial or retrofit installation.

The Han-Yellock® design offer the possibility to snap in the pedestal either on the left or on the right side of the housing.

The direction of the cover movement can flip without turning the housing and inserts.

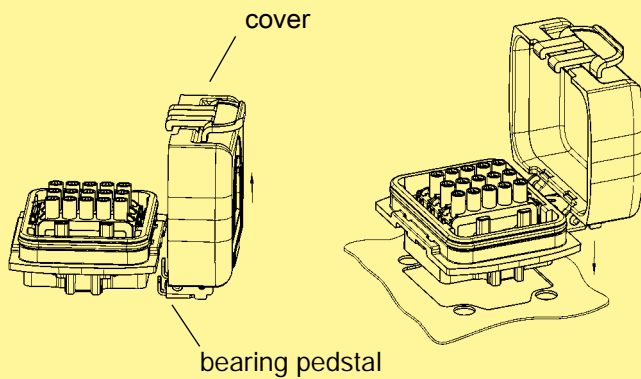

## Han-Yellock® Ground terminal

### Ground terminal assembly

On the housing side ground terminals can be used.

After placing the frame deeply inside the housing slots the housing will be fixed to the panel leading to solid mounting of the complete set.

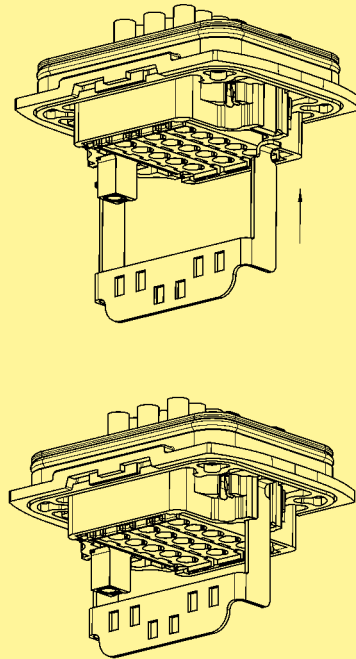

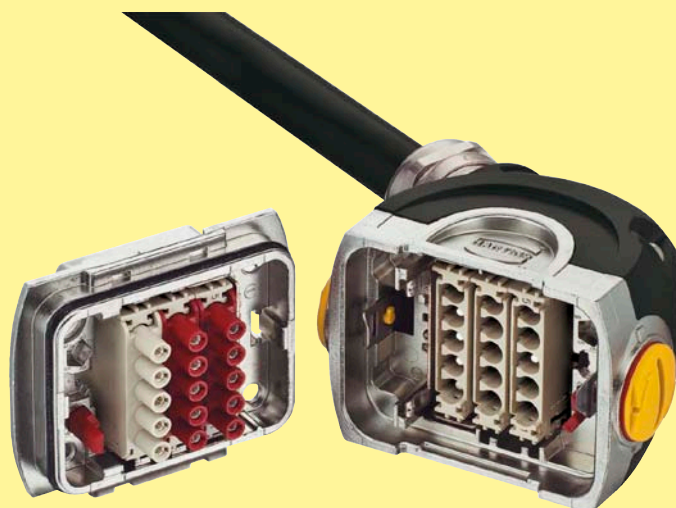

Han-Yellock® hoods/housings



page 14

Han-Yellock® modules

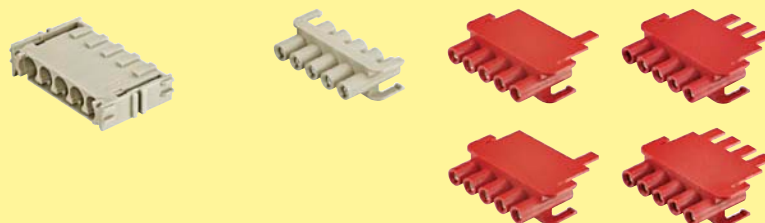

page 20

Han-Yellock® adapter frames



page 24

## Features

- Two-part hoods for easy wiring and testing
- High robustness via an internal locking mechanism
- Earthed contacts PE in crimped or Quick Lock termination technique
- Protection cover retrofit on housing side

## Technical Characteristics

### Shell

Material	aluminium
Surface	powder-coated
Locking element	stainless steel
Limiting temperatures	-40 °C ... +125 °C
Degree of protection acc. to DIN EN 60 529 when locking	IP 67
Tightening torque	
M4 fixing screw	1.2 Nm

### Carrier hoods and Housings, bulkhead mounting

Number of Han-Yellock® modules	
Han-Yellock® 30	3
Han-Yellock® 60	6
Material	Zinc die-cast
Surface	
Locking element	PA / stainless steel
Hoods/Housings sealing	NBR
Limiting temperatures	-40 °C ... +125 °C
Un-/Locking temperature	-10 °C ... +85 °C
Degree of protection acc. to DIN EN 60 529 when locking	IP 67
Mechanical working life	
- mating cycles	500
PE wire	
termination gauge	≤ 4 mm <sup>2</sup>
Tightening torque	
M4 fixing screw	≥ 1 Nm
panel fastener	2.3 Nm

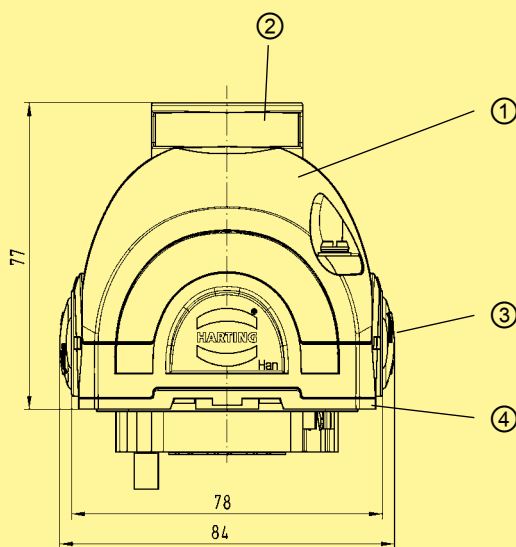



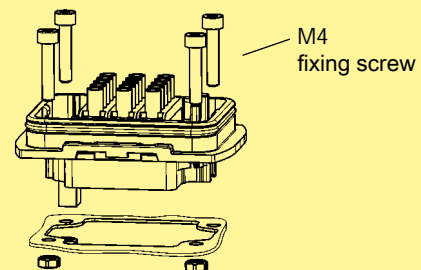
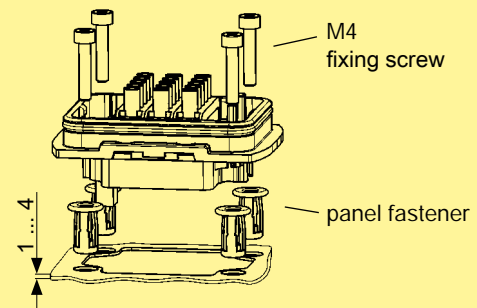



- ① Shell with top entry
- ② cable entry M25
- ③ Carrier hood with push button release
- ④ Housing, bulkhead mounting



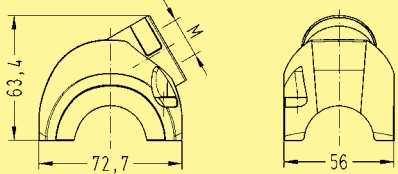

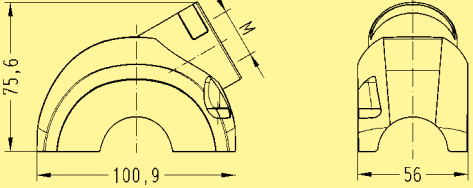

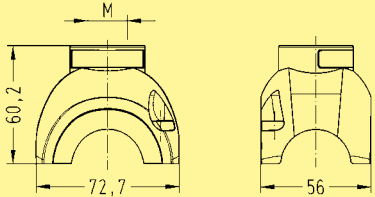
### Protection covers

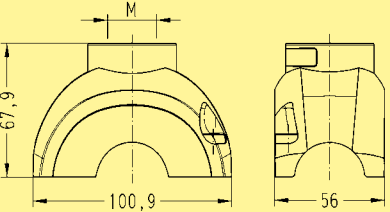
Material	PA
Hoods/Housings sealing	NBR
Degree of protection acc. to DIN EN 60 529 when locking	IP 67
Flammability acc. to UL 94	V0

## Han-Yellok® Hoods

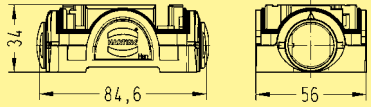
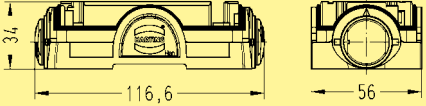

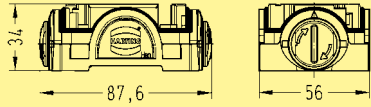
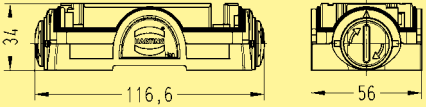
Identification	Part number	Cable entry metric	Drawing	Dimensions in mm		
Shell side entry  Han-Yellok® 30        Han-Yellok® 60		11 12 300 1500	M20		56	
		11 12 300 1501	M25			
		11 12 300 1502	M32			
		11 12 600 1501	M25		56	
		11 12 600 1502	M32			
		11 12 600 1503	M40			
	Shell top entry  Han-Yellok® 30        Han-Yellok® 60		11 12 300 1400	M20		56
			11 12 300 1401	M25		
			11 12 300 1402	M32		
		11 12 600 1401	M25		56	
		11 12 600 1402	M32			
		11 12 600 1403	M40			

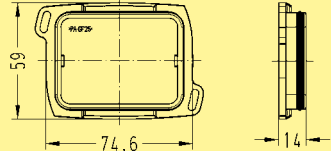
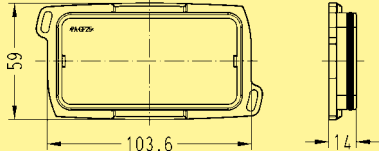
## Han-Yellock® Hoods

Identification	Part number	Cable entry metric	Drawing	Dimensions in mm
Carrier hood plain push button  	Han-Yellock® 30	-		84,6 56
	Han-Yellock® 60	-		116,6 56
Carrier hood push button, slot  	Han-Yellock® 30	-		87,6 56
	Han-Yellock® 60	-		116,6 56
Protection cover for carrier hoods with cord  	Han-Yellock® 30	-		74,6 59 14
	Han-Yellock® 60	-		103,6 59 14

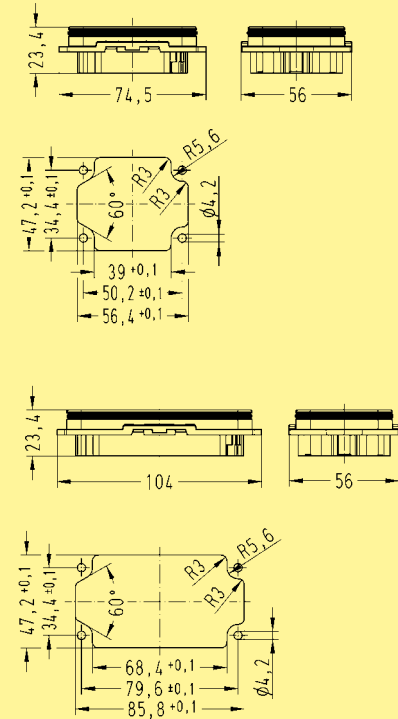

## Han-Yellok® Housings

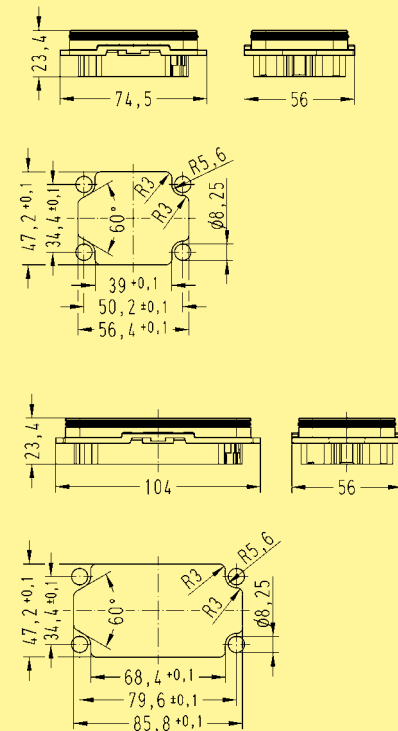
Identification	Part number	Cable entry metric	Drawing	Dimensions in mm
<p>Housing, bulkhead mounting</p>  <p>Han-Yellok® 30</p> <p>Han-Yellok® 60</p>	<p>11 12 300 0301</p> <p>11 12 600 0301</p>			
<p>Housing, bulkhead mounting</p>  <p>Han-Yellok® 30</p> <p>Set consists of Han-Yellok® 30 housing, bulkhead mounting and panel fastener</p> <p>Han-Yellok® 60</p> <p>Set consists of Han-Yellok® 60 housing, bulkhead mounting and panel fastener</p>	<p>11 12 300 0302</p> <p>11 12 600 0302</p>			

## Han-Yellock® Housings

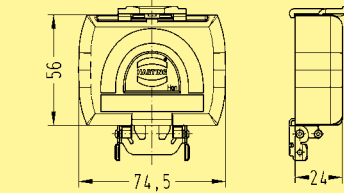
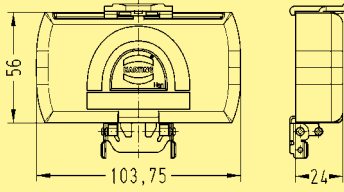
Identification	Part number	Cable entry metric	Drawing	Dimensions in mm
<p>Protection cover for housings, bulkhead mounting</p>  <p>Han-Yellock® 30</p> <p>Set consists of protection cover and bearing pedestal</p> <p>Han-Yellock® 60</p> <p>Set consists of protection cover and bearing pedestal</p>	<p>11 12 300 5401</p> <p>11 12 600 5401</p>		 	



## Features

- Snap-in assembly from mating side and from termination side
- Wiring with male contacts only
- Bus bar within bridge attachments
- Finger safe design
- Fast and tool-less assembly

Placement for Han-Yellok® 30  
with 3 Han-Yellok® modules

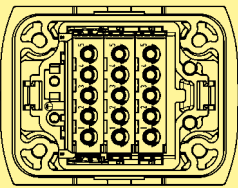

Placement for Han-Yellok® 60  
with 6 Han-Yellok® modules

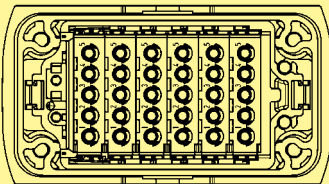

## Current carrying capacity

The current carrying capacity of the connectors is limited by the thermal load capability of the contact element material including the connections and the insulating parts. The derating curve is therefore valid for currents which flow constantly (non-intermittent) through each contact element of the connector evenly, without exceeding the allowed maximum temperature.

Measuring and testing techniques according to DIN EN 60 512-5

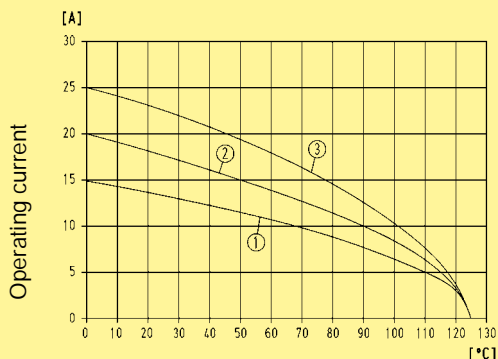

Ambient temperature

① Wire gauge: 1.5 mm<sup>2</sup>

② Wire gauge: 2.5 mm<sup>2</sup>

③ Wire gauge: 4.0 mm<sup>2</sup>

for connector with 3 Han-Yellok® modules, fully loaded  
(multiplier 1:1)

## Technical Characteristics

Specifications	DIN EN 60 664-1 DIN EN 61 984
----------------	----------------------------------

### Modules

Electrical data acc. to DIN EN 61 984	<b>20 A 500 V 6 kV 3</b>
Rated current	20 A
Rated voltage	500 V
Rated impulse voltage	6 kV
Pollution degree	3
Pollution degree 2 also	20 A 690 V 8 kV 2

Insulation resistance	≥ 10 <sup>10</sup> Ω
Material	Polycarbonate
Limiting temperatures	-40 °C ... +125 °C
Flammability acc. to UL 94	V0
Mechanical working life - mating cycles	≥ 500

### Contacts

Material	copper alloy
Surface	
- hart-silver plated	3 μm Ag
Contact resistance	≤ 2 mΩ
Crimp terminal	
- wire gauge <sup>1)</sup>	0.14 ... 4 mm <sup>2</sup>
- AWG	26 ... 12
- Stripping length	6.5 mm

Number of contacts

# 5



Identification	Part number	Drawing	Dimensions in mm
Han-Yellock® module	11 05 105 3001		

Identification	Wire gauge (mm²)	Part number	Drawing	Dimensions in mm																											
Han-Yellock® Crimp contacts male contact Han-Yellock® TC20  silver-plated  	0.14-0.37 0.5 0.75 1.0 1.5 2.5 3.0 4.0	11 05 000 6101 11 05 000 6102 11 05 000 6103 11 05 000 6104 11 05 000 6105 11 05 000 6106 11 05 000 6107 11 05 000 6108	  <table border="1"> <thead> <tr> <th colspan="2">Wire gauge</th> <th>Stripping length</th> </tr> </thead> <tbody> <tr> <td>0.14 - 0.37</td> <td>mm² AWG 26-22</td> <td>6.5 mm</td> </tr> <tr> <td>0.5</td> <td>mm² AWG 20</td> <td>6.5 mm</td> </tr> <tr> <td>0.75</td> <td>mm² AWG 18</td> <td>6.5 mm</td> </tr> <tr> <td>1</td> <td>mm² AWG 18</td> <td>6.5 mm</td> </tr> <tr> <td>1.5</td> <td>mm² AWG 16</td> <td>6.5 mm</td> </tr> <tr> <td>2.5</td> <td>mm² AWG 14</td> <td>6.5 mm</td> </tr> <tr> <td>3</td> <td>mm² AWG 12</td> <td>6.5 mm</td> </tr> <tr> <td>4</td> <td>mm² AWG 12</td> <td>6.5 mm</td> </tr> </tbody> </table>	Wire gauge		Stripping length	0.14 - 0.37	mm² AWG 26-22	6.5 mm	0.5	mm² AWG 20	6.5 mm	0.75	mm² AWG 18	6.5 mm	1	mm² AWG 18	6.5 mm	1.5	mm² AWG 16	6.5 mm	2.5	mm² AWG 14	6.5 mm	3	mm² AWG 12	6.5 mm	4	mm² AWG 12	6.5 mm	
Wire gauge		Stripping length																													
0.14 - 0.37	mm² AWG 26-22	6.5 mm																													
0.5	mm² AWG 20	6.5 mm																													
0.75	mm² AWG 18	6.5 mm																													
1	mm² AWG 18	6.5 mm																													
1.5	mm² AWG 16	6.5 mm																													
2.5	mm² AWG 14	6.5 mm																													
3	mm² AWG 12	6.5 mm																													
4	mm² AWG 12	6.5 mm																													







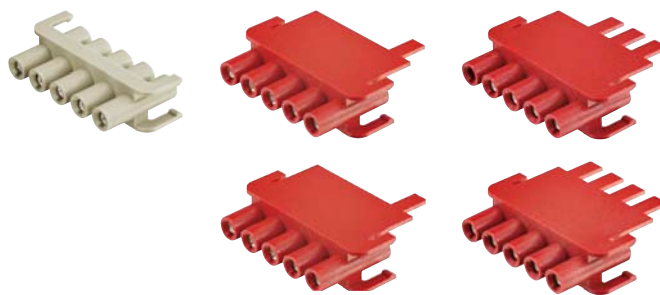

Removal tool for crimp contacts	09 99 000 0319	
---------------------------------	----------------	--

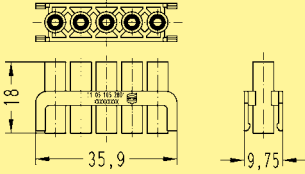

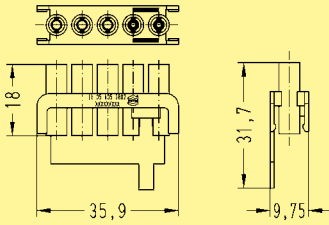
Number of contacts

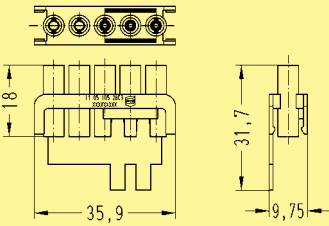
# 5

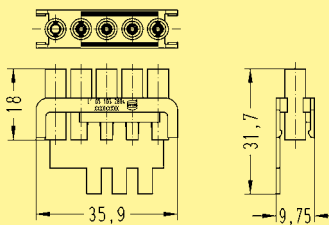

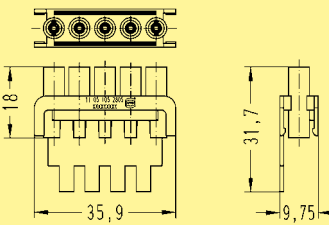
Identification	Part number	Drawing	Dimensions in mm
<b>Han-Yellock® multiplier</b>			
multiplier 1:1 	<b>11 05 105 2801</b>		
multiplier 2:3 	<b>11 05 105 2802</b>		
multiplier 3:2 	<b>11 05 105 2803</b>		
multiplier 4:1 	<b>11 05 105 2804</b>		
multiplier 5:0 	<b>11 05 105 2805</b>		

## Features

- Suitable for Han-Modular® modules up to 4 mm<sup>2</sup>
- Snap-in functionality from mating side and from termination side

## Technical Characteristics

Specifications	DIN EN 60 664-1 DIN EN 61 984
----------------	----------------------------------

### Adapter frames

Number of modules	max. 2
Material	Polycarbonate
Flammability acc. to UL 94	V0

## Mounting

- The adapter frame can be snapped into the housing, bulkhead mounting, on the connection side and the plug-in side (refer to the illustration).
- The lateral plastic tabs („B“) are pressed into the metal clamps on the housing.
- The adapter frame then snaps in with a distinctly audible click.

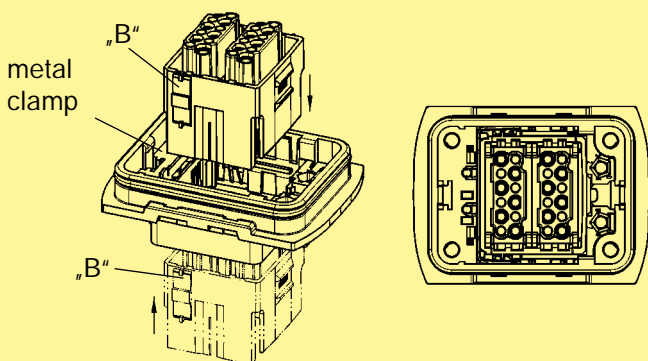

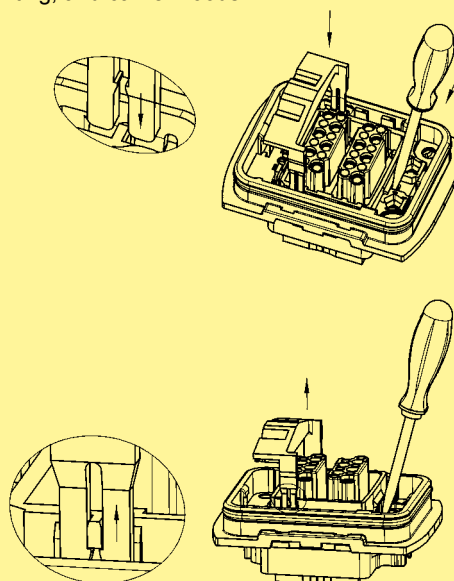

## Removal

- The removal tool part no. 09 99 000 0001 is required for removal.
- The removal tool is inserted into the metal clamp and pressed down as shown in the following illustration. A screwdriver can also be placed into the notch in the housing.
- The removal tool should then be pulled outwards to remove the adapter frame from the housing.
- The removal can be made from the connection side as well as from the plug-in side.
- The process is identical for both housings, bulkhead mounting, and carrier hoods.



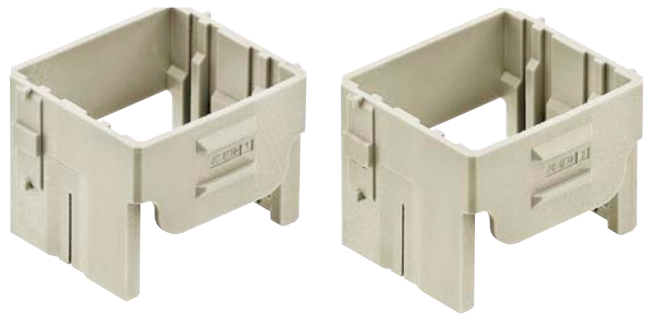













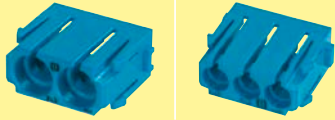







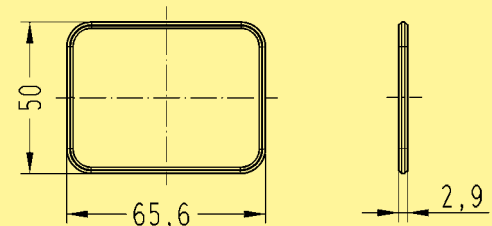
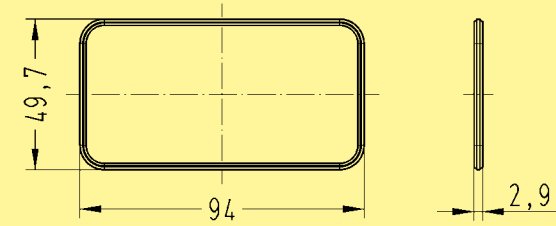

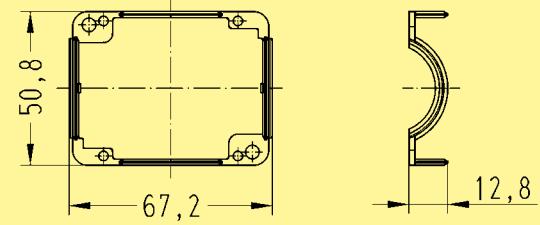
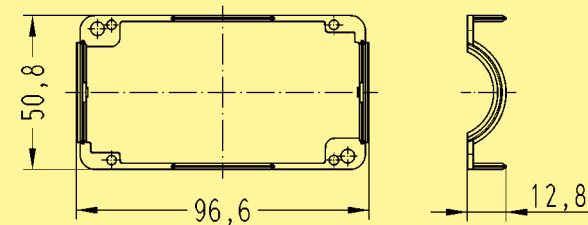

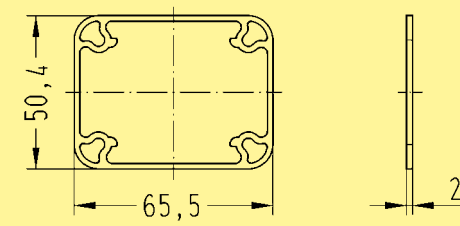
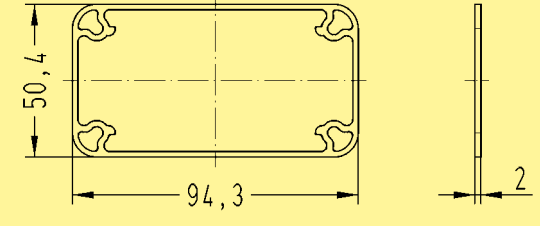

Identification	Part number	Drawing	Dimensions in mm
<p>Han-Yellock® 30 Adapter frame</p> <p>for carrier hoods</p> 	<p><b>11 00 300 0101</b></p>		
<p>for housings, bulkhead mounting</p> 	<p><b>11 00 300 0301</b></p>		

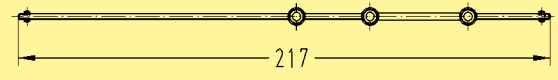
Modules	Han® CC Protected module	Han® CD module	Han E® module	Han® EE module
Number of contacts	4	3 / 4	6	8
Termination	Crimp terminal	Crimp terminal	Crimp terminal	Crimp terminal
Rated current	40 A	40 A / 10 A	16 A	16 A
Rated voltage	830 V	830 V / 830 V	500 V	400 V
Wire gauge	1.5 - 6 mm <sup>2</sup>	1.5 - 6 mm <sup>2</sup> / 0.14 - 2.5 mm <sup>2</sup>	0.5 - 4 mm <sup>2</sup>	0.5 - 4 mm <sup>2</sup>
Modules	Han® EE module	Han E® Protected module	Han® EEE module	Han® ES module
Number of contacts	8	6	20	5
Termination	Quick Lock terminal	Crimp terminal	Crimp terminal	Cage-clamp terminal
Rated current	16 A	16 A	16 A	16 A
Rated voltage	400 V	830 V	500 V	400 V
Wire gauge	0.5 - 2.5 mm <sup>2</sup>	0.5 - 4 mm <sup>2</sup>	0.5 - 4 mm <sup>2</sup>	0.14 - 2.5 mm <sup>2</sup>
Modules	Han DD® module	Han® DDD module	Han® High Density module	Han® D-Sub module
Number of contacts	12	17	25	9
Termination	Crimp terminal	Crimp terminal	Crimp terminal	Crimp terminal
Rated current	10 A	10 A	4 A	5 A
Rated voltage	250 V	160 V	50 V	50 V
Wire gauge	0.14 - 2.5 mm <sup>2</sup>	0.14 - 2.5 mm <sup>2</sup>	0.08 - 0.52 mm <sup>2</sup>	0.08 - 0.52 mm <sup>2</sup>
Modules	Han® USB module	Han® FireWire module	Han® RJ45 module	Han® GigaBit module
Number of contacts	4	6	8	8
Termination	USB 2.0	IEEE 1394	Ethernet Cat. 5e	Ethernet Cat. 6

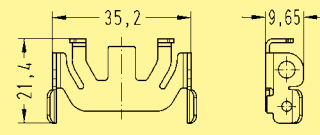
Modules	Han-Quintax® module				Han® Multi Contact module	
Number of contacts	2				4	
Contacts	 <p>Quintax contact 4 + shielding</p>	 <p>High Density Quintax contact 8 + shielding</p>	 <p>Han D° Coax contact 1 + shielding</p> <p>75 Ω</p>	 <p>Han E° Coax contact 1 + shielding</p> <p>50 Ω</p>	 <p>F.O. contact</p> <p>Multimode F.O. HCS®*/PCF F.O. 1 mm POF</p>	 <p>Coaxial contact</p> <p>50 Ω RG 174 75 Ω RG 179 50 Ω RG 58</p>
Modules	Han® Pneumatic module		Han® SC module			
Number of contacts	2		3		4	
Contacts	 <p>Pneumatic contacts</p>  <p>Ø 6.0 mm</p>		 <p>SC contact</p>  <p>Ø 1.6 mm Ø 3.0 mm Ø 4.0 mm</p>			

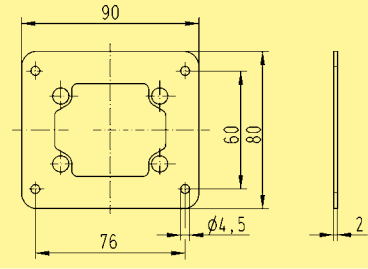
\* HCS®=Hard Clad Silica (is registered trade mark of SpecTran Corporation)

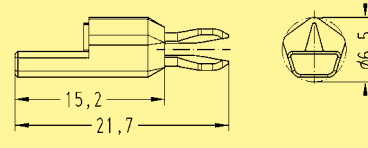
Identification	Part number	Drawing	Dimensions in mm
<p><b>Han-Yellock® Profile seal</b></p>  <p>for Han-Yellock® 30</p>	<p>11 00 300 9501</p>		
<p>for Han-Yellock® 60</p>	<p>11 00 600 9501</p>		
<p><b>Han-Yellock® Seal for carrier hoods</b></p>  <p>for Han-Yellock® 30</p>	<p>11 00 300 9502</p>		
<p>for Han-Yellock® 60</p>	<p>11 00 600 9502</p>		
<p><b>Han-Yellock® Gasket</b></p>  <p>for Han-Yellock® 30</p>	<p>11 00 300 9503</p>		
<p>for Han-Yellock® 60</p>	<p>11 00 600 9503</p>		

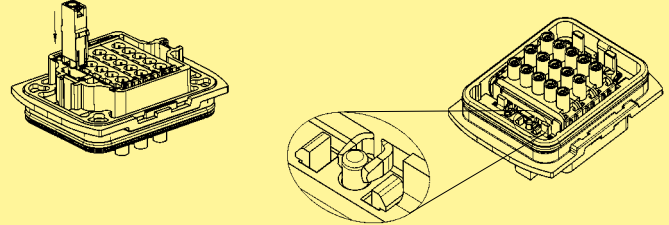
Identification	Part number	Drawing	Dimensions in mm
<p>Han-Yellock® Fixing cord for protection cover cable side</p> 	11 00 000 9507		
<p>Han-Yellock® Bearing pedestal</p> 	11 00 000 9506		
<p>Han-Yellock® 30 Adapter plate circular 68 mm punch to Han-Yellock® panel cut out</p> 	11 00 300 9601		
<p>Han-Yellock® Identification sticks</p>	11 00 000 9601		
<p>Han-Yellock® Coding pins Set of 8 coding pins</p> 	11 00 000 9501		
<p>PE Contact chamber with Quick Lock termination</p> 	11 05 001 2601		

Identification	Part number	Drawing	Dimensions in mm
<p>BUCHANAN crimping tool</p> <p>Locator Han-<i>Yellock</i><sup>®</sup></p> <p>Multiple crimping tool depth adjustment gauge</p>	<p><b>09 99 000 0001</b></p> <p><b>09 99 000 0342</b></p> <p><b>09 99 000 0379</b></p>	<p>Wire gauge 0.14 ... 4 mm<sup>2</sup></p> <p>Wire gauge 0.14 ... 0.37 mm<sup>2</sup> Ø 1.00 0.5 ... 1.0 mm<sup>2</sup> Ø 1.55 1.5 ... 2.5 mm<sup>2</sup> Ø 1.80 3.0 ... 4.0 mm<sup>2</sup> Ø 2.00</p>	<p>order separately</p>
<p>HARTING crimping tool Han D<sup>®</sup>, Han E<sup>®</sup>, Han<sup>®</sup> C locator included</p> <p>Locator Han-<i>Yellock</i><sup>®</sup></p>	<p><b>09 99 000 0110</b></p> <p><b>09 99 000 0341</b></p>	<p>Wire gauge 0.5 ... 4 mm<sup>2</sup></p>	
<p>HARTING Service crimping tool Han D<sup>®</sup>, Han E<sup>®</sup> locator included</p> <p>Locator Han-<i>Yellock</i><sup>®</sup></p>	<p><b>09 99 000 0021</b></p> <p><b>09 99 000 0343</b></p>	<p>Wire gauge 0.14 ... 1.5 mm<sup>2</sup></p>	
<p>Removal tool for Han-<i>Yellock</i><sup>®</sup> modules and frames</p>	<p><b>11 99 000 0001</b></p>		
<p>Removal tool for crimp contacts</p>	<p>09 99 000 0319</p>	<p>This removal tool is necessary if contacts are to be replaced in the insert. The tool is inserted from the wiring side until a stop is noticeable. The wire with the crimp contact can then be pulled out from the same side of the insert.</p>	
<p>Panel Punch panel cut out tool panel thickness steel: ≤ 2.5 mm stainless steel: ≤ 2.0 mm for hydraulic pump punch force: ≥ 60 kN thread: 3/4" UNF</p> <p>for Han-<i>Yellock</i><sup>®</sup> 30</p>	<p><b>11 99 300 0001</b></p>		

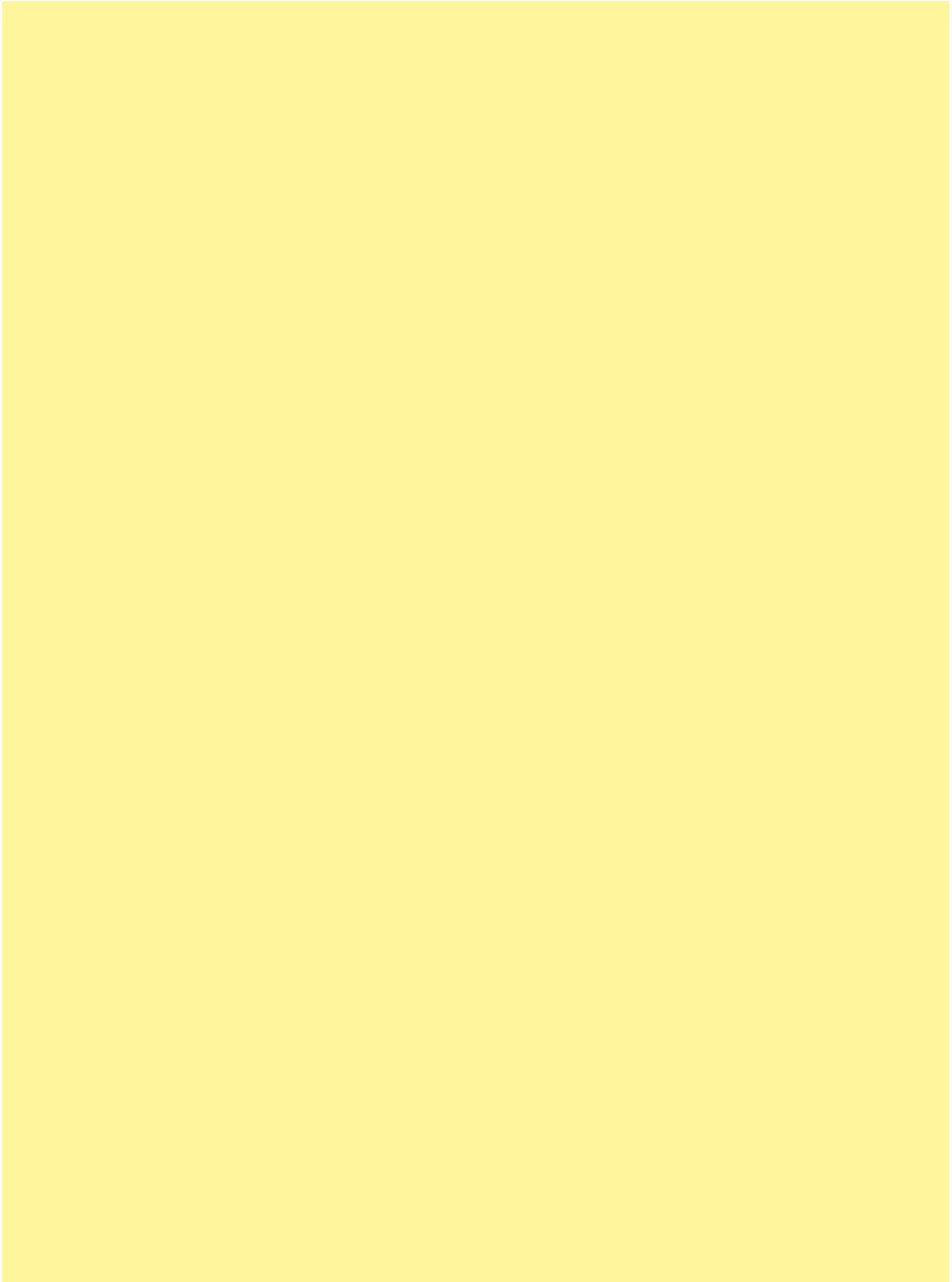

Part number	Page	Part number	Page
09 99 000 0001	30	11 12 300 0100	16
09 99 000 0021	30	11 12 300 0110	16
09 99 000 0110	30	11 12 300 0301	17
09 99 000 0319	21	11 12 300 0302	17
09 99 000 0319	30	11 12 300 1400	15
09 99 000 0341	30	11 12 300 1401	15
09 99 000 0342	30	11 12 300 1402	15
09 99 000 0343	30	11 12 300 1500	15
09 99 000 0379	30	11 12 300 1501	15
		11 12 300 1502	15
		11 12 300 5401	18
11 00 000 9501	29	11 12 300 5451	16
11 00 000 9506	29		
11 00 000 9507	29	11 12 600 0100	16
11 00 000 9601	29	11 12 600 0101	16
		11 12 600 0301	17
11 00 300 0101	25	11 12 600 0302	17
11 00 300 0301	25	11 12 600 1401	15
11 00 300 9501	28	11 12 600 1402	15
11 00 300 9502	28	11 12 600 1403	15
11 00 300 9503	28	11 12 600 1501	15
11 00 300 9601	29	11 12 600 1502	15
		11 12 600 1503	15
11 00 600 9501	28	11 12 600 5401	18
11 00 600 9502	28	11 12 600 5451	16
11 00 600 9503	28		
		11 99 000 0001	30
		11 99 300 0001	30
11 05 000 6101	21		
11 05 000 6102	21		
11 05 000 6103	21		
11 05 000 6104	21		
11 05 000 6105	21		
11 05 000 6106	21		
11 05 000 6107	21		
11 05 000 6108	21		
11 05 001 2601	29		
11 05 105 2801	23		
11 05 105 2802	23		
11 05 105 2803	23		
11 05 105 2804	23		
11 05 105 2805	23		
11 05 105 3001	21		



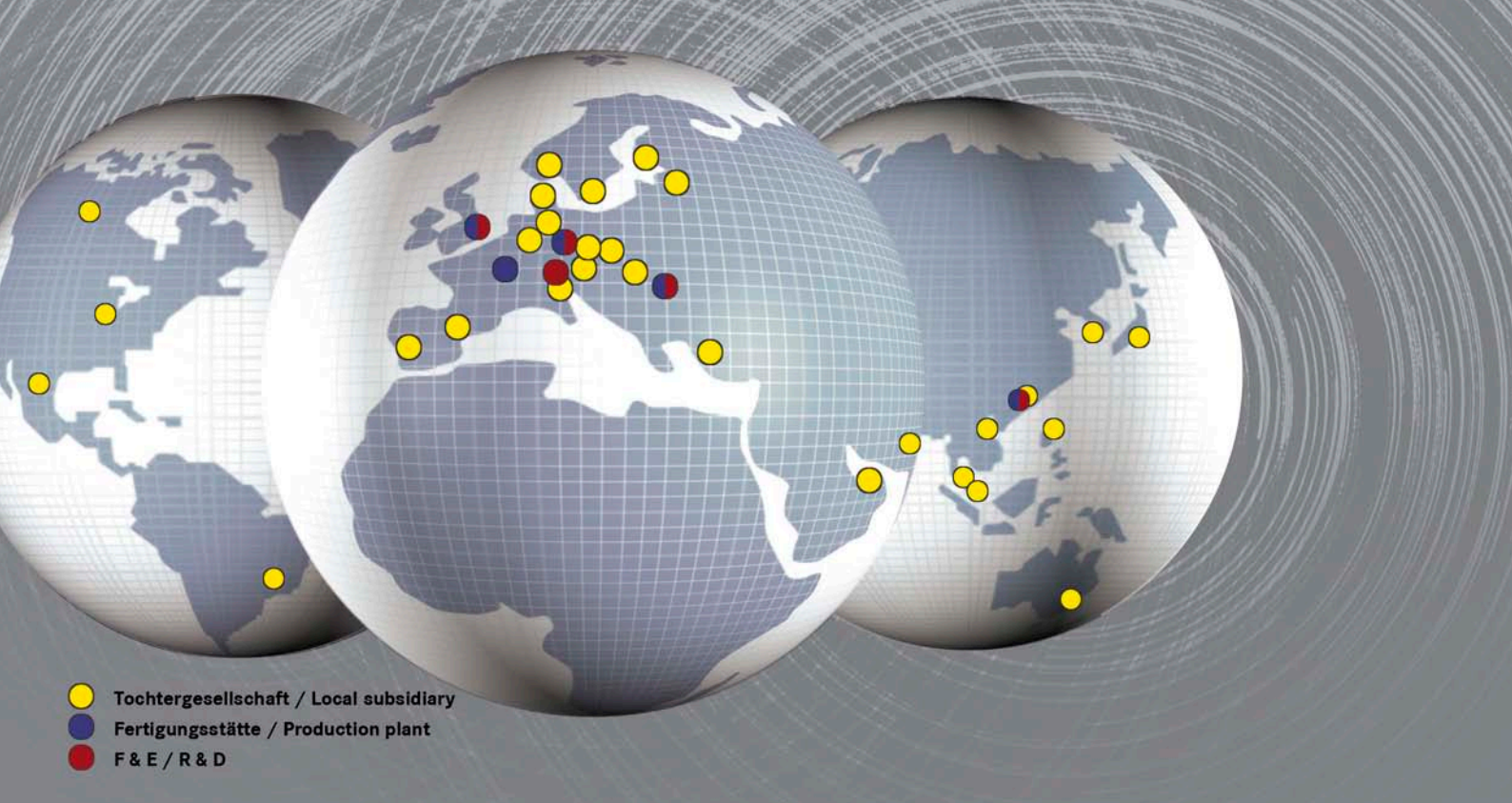

## Sales Network – worldwide



### Albania

see Eastern Europe

### Argentina

see Brazil

### Armenia

see Eastern Europe

### Australia

HARTING Pty Ltd  
Suite 11 / 2 Enterprise Drive  
Bundoora 3083, AUS-Victoria  
Phone +61 9466 7088  
Fax +61 9466 7099  
au@HARTING.com  
www.HARTING.com

### Austria

HARTING Ges.m.b.H.  
Deutschstraße 19, A-1230 Wien  
Phone +431 6162121  
Fax +431 6162121-21  
at@HARTING.com  
www.HARTING.at

### Azerbaijan

see Eastern Europe

### Belarus

see Eastern Europe

### Belgium

HARTING N.V./S.A.  
Z.3 Doornveld 23, B-1731 Zellik  
Phone +32 2 466 0190  
Fax +32 2 466 7855  
be@HARTING.com  
www.HARTING.be

### Bosnia and Herzegovina

see Eastern Europe

### Brazil

HARTING Ltda.  
Av. Dr. Lino de Moraes  
Pq. Jabaquara, 255  
CEP 04360-001 – São Paulo –  
SP – Brazil  
Phone +55 11 5035 0073  
Fax +55 11 5034 4743  
br@HARTING.com  
www.HARTING.com.br

### Brunei

see Singapore

### Bulgaria

see Eastern Europe

### Canada

see USA

### China

Zhuhai HARTING Limited  
Shanghai branch  
Room 5403, HK New World Tower  
300 Huai Hai Road (M.)  
Shanghai 200021, China  
Phone +86 21 6386 2200  
Fax +86 21 6386 8636  
cn@HARTING.com  
www.HARTING.com.cn

### Croatia

see Eastern Europe

### Czech Republic

HARTING s.r.o.  
Mlýnská 2, CZ-160 00 Praha 6  
Phone +420 220 380 460  
Fax +420 220 380 461  
cz@HARTING.com  
www.HARTING.cz

### Denmark

HARTING ApS  
Hjulmagervej 4a  
DK - 7100 Vejle  
Phone +45 70 25 00 32  
Fax +45 75 80 64 99  
dk@HARTING.com  
www.HARTING.com

**Eastern Europe**

HARTING Eastern Europe GmbH  
Bamberger Straße 7  
D-01187 Dresden  
Phone +49 351 4361 760  
Fax +49 351 436 1770  
Eastern.Europe@HARTING.com  
www.HARTING.com

**Estonia**

see Eastern Europe

**Finland**

HARTING Oy  
Teknobulevardi 3-5, PL 35  
FI-01530 Vantaa  
Phone +358 9 350 87 300  
Fax +358 9 350 87 320  
fi@HARTING.com  
www.HARTING.fi

**France**

HARTING France  
181 avenue des Nations, Paris Nord 2  
BP 66058 Tremblay en France  
F-95972 Roissy Charles de Gaulle  
Cédex  
Phone +33 1 4938 3400  
Fax +33 1 4863 2306  
fr@HARTING.com  
www.HARTING.fr

**Germany**

HARTING Deutschland GmbH & Co. KG  
P.O. Box 2451, D-32381 Minden  
Simeons carré 1, D-32427 Minden  
Phone +49 571 8896 0  
Fax +49 571 8896 282  
de@HARTING.com  
www.HARTING-Deutschland.de

**Germany (Office)**

HARTING Deutschland GmbH & Co. KG  
Blankenauer Straße 99  
D-09113 Chemnitz  
Phone +49 0371 429211  
Fax +49 0371 429222  
de@HARTING.com  
www.HARTING-Deutschland.de

**Georgia**

see Eastern Europe

**Great Britain**

HARTING Ltd., Caswell Road  
Brackmills Industrial Estate  
GB-Northampton, NN4 7PW  
Phone +44 1604 827 500  
Fax +44 1604 706 777  
gb@HARTING.com  
www.HARTING.co.uk

**Hong Kong**

HARTING (HK) Limited  
Regional Office Asia Pacific  
3512 Metroplaza Tower 1  
223 Hing Fong Road  
Kwai Fong, N. T., Hong Kong  
Phone +852 2423 7338  
Fax +852 2480 4378  
ap@HARTING.com  
www.HARTING.com.hk

**Hungary**

HARTING Magyarország Kft.  
Fehérvári út 89-95, H-1119 Budapest  
Phone +36 1 205 34 64  
Fax +36 1 205 34 65  
hu@HARTING.com  
www.HARTING.hu

**Iceland**

Smith & Norland, Nóatún 4  
IS – 105 Reykjavík  
Phone +354 520 3000  
Fax +354 520 3011  
olaf@sminor.is, www.sminor.is

**India**

HARTING India Private Limited  
No. D, 4th Floor, 'Doshi Towers'  
No. 156 Poonamallee High Road  
Kilpauk, Chennai 600 010  
Tamil Nadu, India  
Phone +91 44 435604 15 / 416  
Fax +91 44 435604 17  
in@HARTING.com  
www.HARTING.com

**Indonesia**

see Malaysia

**Israel**

COMTEL  
Israel Electronic Solutions Ltd.  
Bet Hapamon, 20 Hataas st.  
P.O.Box 66  
Kefar-Saba 44425  
Phone +972-9-7677240  
Fax +972-9-7677243  
sales@comtel.co.il  
www.comtel.co.il

**Italy**

HARTING SpA  
Via Dell' Industria 7  
I-20090 Vimodrone (Milano)  
Phone +39 02 250801  
Fax +39 02 2650 597  
it@HARTING.com  
www.HARTING.it

**Japan**

HARTING K. K.  
Yusen Shin-Yokohama 1 Chome Bldg., 2F  
1-7-9, Shin-Yokohama, Kohoku-ku  
Yokohama 222-0033 Japan  
Phone +81 45 476 3456  
Fax +81 45 476 3466  
jp@HARTING.com  
www.HARTING.co.jp

**Kazakhstan**

see Eastern Europe

**Kirghizia**

see Eastern Europe

**Korea (South)**

HARTING Korea Limited  
#308 Yatap Leaders Building, 342-1  
Yatap-dong, Bundang-gu  
Sungnam-City, Kyunggi-do  
463-828, Republic of Korea  
Phone +82 31 781 4615  
Fax +82 31 781 4616  
kr@HARTING.com  
www.HARTING.com.cn/kr

**Kosovo**

see Eastern Europe

**Latvia**

see Eastern Europe

**Lithuania**

see Eastern Europe

**Macedonia**

see Eastern Europe

**Malaysia (Office)**

HARTING Singapore Pte Ltd  
Malaysia Branch  
11-02 Menara Amcorp  
Jln. Persiaran Barat  
46200 PJ, Sel. D. E., Malaysia  
Phone +60 3 / 7955 6173  
Fax +60 3 / 7955 5126  
sg@HARTING.com

**Montenegro**

see Eastern Europe

**Netherlands**

HARTING B.V.  
Larenweg 44  
NL-5234 KA 's-Hertogenbosch  
Postbus 3526  
NL-5203 DM 's-Hertogenbosch  
Phone +31 736 410 404  
Fax +31 736 440 699  
nl@HARTING.com  
www.HARTINGbv.nl

**New Zealand**

see Australia

## Norway

HARTING A/S  
Østensjøveien 36, N-0667 Oslo  
Phone +47 22 700 555  
Fax +47 22 700 570  
no@HARTING.com  
www.HARTING.no

## Philippines

see Malaysia

## Poland

HARTING Polska Sp. z o. o.  
ul. Kamieńskiego 201-219  
PL-51-126 Wrocław  
Phone +48 71 352 81 71  
Fax +48 71 320 74 44  
pl@HARTING.com  
www.HARTING.pl

## Portugal

HARTING Iberia, S. A.  
Avda. Josep Tarradellas 20-30 4º 6a  
E-08029 Barcelona  
Phone +351 219 673 177  
Fax +351 219 678 457  
es@HARTING.com  
www.HARTING.es/pt

## Republic of Moldova

see Eastern Europe

## Romania

HARTING Romania SCS  
Europa Unita str. 21  
550018-Sibiu, Romania  
Phone +40 369-102 671  
Fax +40 369-102 622  
ro@HARTING.com  
www.HARTING.com

## Russia

HARTING ZAO  
Maliy Sampsoniyevsky prospect 2A  
194044 Saint Petersburg, Russia  
Phone +7 812 327 6477  
Fax +7 812 327 6478  
ru@HARTING.com  
www.HARTING.ru

## Serbia

see Eastern Europe

## Singapore

HARTING Singapore Pte Ltd.  
25 International Business Park  
#02-06 German Centre  
Singapore 609916  
Phone +65 6225 5285  
Fax +65 6225 9947  
sg@HARTING.com  
www.HARTING.com

## Slovakia

HARTING s.r.o.  
Sales office Slovakia  
Povázska 2, SK - 940 67 Nové Zámky  
Phone +421 356-493 993  
Fax +421 356-402 114  
sk@HARTING.com  
www.HARTING.sk

## Slovenia

see Eastern Europe

## South Africa

HellermannTyton Pty Ltd.  
Private Bag X158 Rivonia 2128  
34 Milky Way Avenue  
Linbro Business Park 2065, Johannesburg  
Phone +27(0)11879-6600  
Fax +27(0)11879-6606  
sales.jhb@hellermann.co.za

## Spain

HARTING Iberia S.A.  
Avda. Josep Tarradellas 20-30 4º 6ª  
E-08029 Barcelona  
Phone +34 93 363 84 75  
Fax +34 93 419 95 85  
es@HARTING.com  
www.HARTING.es

## Sweden

HARTING AB  
Gustavslundsvägen 141 B 4tr  
S-167 51 Bromma  
Phone +46 8 445 7171  
Fax +46 8 445 7170  
se@HARTING.com  
www.HARTING.se

## Switzerland

HARTING AG  
Industriestrasse 26  
CH-8604 Volketswil  
Phone +41 44 908 20 60  
Fax +41 44 908 20 69  
ch@HARTING.com  
www.HARTING.ch

## Taiwan

HARTING R.O.C. Limited  
Room 1, 5/F  
495 GuangFu South Road  
RC-110 Taipei, Taiwan  
Phone +886 227 586 177  
Fax +886 227 587 177  
tw@HARTING.com  
www.HARTING.com.tw

## Tajikistan

see Eastern Europe

## Thailand

see Malaysia

## Turkey

HARTING TURKEI Elektronik Ltd. Şti.  
Barbaros Mah. Dereboyu Cad.  
Fesleğen Sok.  
Uphill Towers, A-1b Kat:8 D:45  
34746 Ataşehir, İstanbul  
Phone +90 216 688 81 00  
Fax +90 216 688 81 01  
ahmetcan.ayan@HARTING.com  
www.HARTING.com.tr

## Turkmenistan

see Eastern Europe

## Ukraine

see Eastern Europe

## USA

HARTING Inc. of North America  
1370 Bowes Road  
USA-Elgin, Illinois 60123  
Phone +1 (877) 741-1500 (toll free)  
Fax +1 (866) 278-0307 (Inside Sales)  
Fax +1 (847) 717-9430 (Sales and Marketing)  
us@HARTING.com  
www.HARTING-USA.com

## Uzbekistan

see Eastern Europe

## Vietnam (Office)

HARTING Singapore Pte Ltd  
Hanoi Representative Office  
Suite 518, 5th Floor  
Press Club Building  
59A Ly Thai To Street  
Hoan Kiem District  
Hanoi, Vietnam  
Phone +84 4 / 3936 7851  
Fax +84 4 / 3936 8069  
sg@HARTING.com

## Distributors – worldwide



Farnell:  
www.farnell.com

RS Components:  
www.rs-components.com

## Other countries and general contact



HARTING Electric GmbH & Co. KG  
P.O. Box 1473, D-32328 Espelkamp  
Phone +49 5772 47-97100  
Fax + 49 5772 47-495  
electric@HARTING.com



**Pushing Performance**

[www.HARTING.com](http://www.HARTING.com)