



LED Display Product Data Sheet LTS-2301AWC

Spec No.: DS-30-98-019

Effective Date: 01/26/2005

Revision: A

LITE-ON DCC

RELEASE

BNS-OD-FC001/A4

FEATURES

- * 0.28 inch (7.0-mm) DIGIT HEIGHT
- * CONTINUOUS UNIFORM SEGMENTS
- * LOW POWER REQUIREMENT
- * EXCELLENT CHARACTERS APPEARANCE
- * HIGH BRIGHTNESS & HIGH CONTRAST
- * WIDE VIEWING ANGLE
- * SOLID STATE RELIABILITY
- * CATEGORIZED FOR LUMINOUS INTENSITY
- * **LEAD-FREE PACKAGE (ACCORDING TO ROHS)**

DESCRIPTION

The LTS-2301AWC is a 0.28 inch (7-mm) digit height single digit low current seven-segment display. This device uses AlGaAs red LED chips(AlGaAs epi on GaAs substrate). The display has gray face and white segments.

This low current seven-segment display is designed to perform under low power consumption. It is tested and selected for it's excellent low current characteristics. It can be driven in low current condition and the segments are matched. This driving current as low as 1mA per segment is applicable.

DEVICE

PART NO.	DESCRIPTION
AlGaAs RED	Common Cathode
LTS-2301AWC	Rt. Hand Decimal

PACKAGE DIMENSIONS

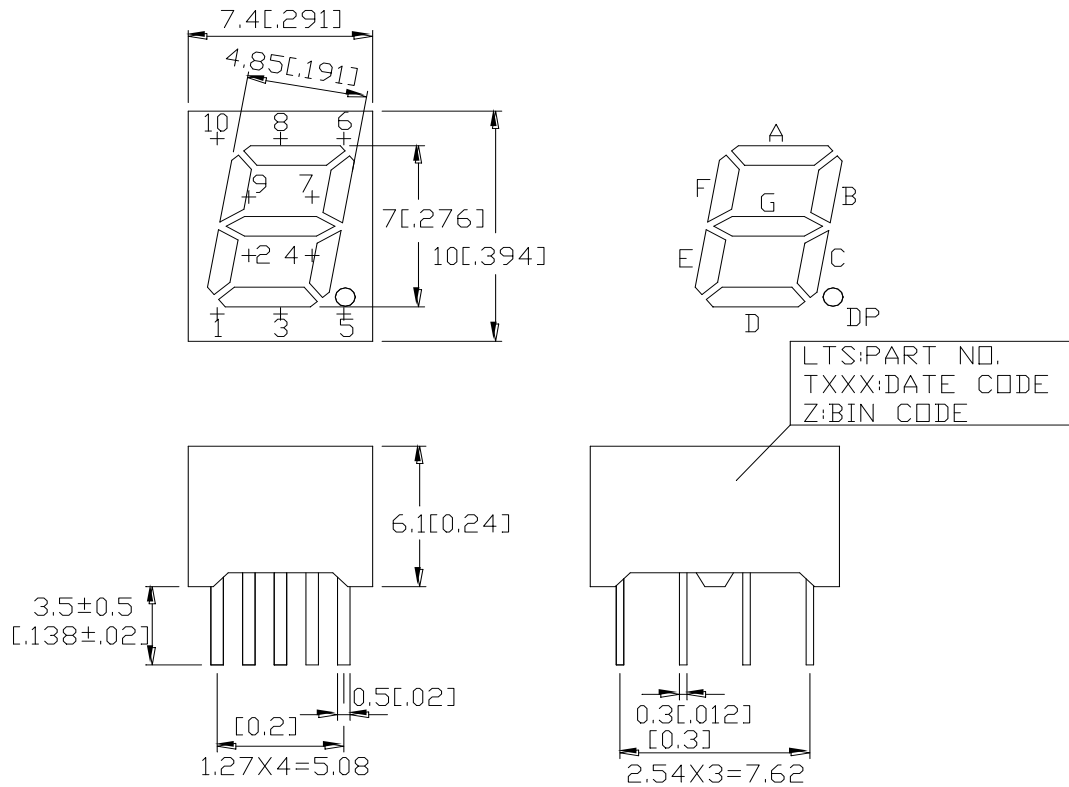

NOTES: All dimensions are in millimeters. Tolerance is ± 0.25 mm (0.01") unless otherwise noted.

INTERNAL CIRCUIT DIAGRAM

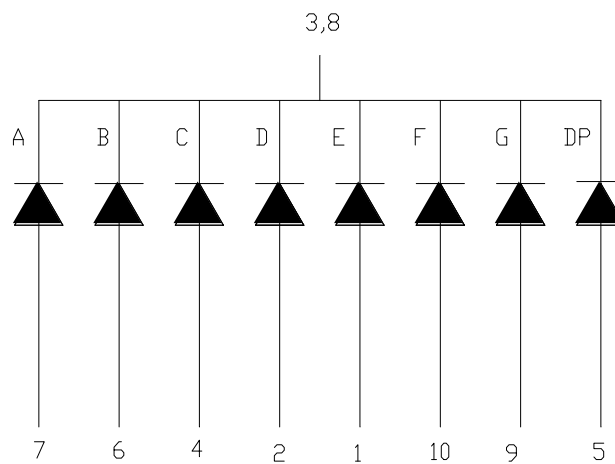

PIN CONNECTION

No.	CONNECTION
1	ANODE E
2	ANODE D
3	COMMON CATHODE
4	ANODE C
5	ANODE D.P.
6	ANODE B
7	ANODE A
8	COMMON CATHODE
9	ANODE G
10	ANODE F

ABSOLUTE MAXIMUM RATING

PARAMETER	MAXIMUM RATING	UNIT
Power Dissipation Per Segment	75	mW
Peak Forward Current Per Segment (Frequency 1Khz, 10% duty cycle)	125*	mA
Continuous Forward Current Per Segment	30	mA
Forward Current Derating from 25 ⁰ C	0.4	mA/ ⁰ C
Reverse Voltage Per Segment	5	V
Operating Temperature Range	-35 ⁰ C to +85 ⁰ C	
Storage Temperature Range	-35 ⁰ C to +85 ⁰ C	
Soldering Conditions: 1/16 inch below eating plane for 3 seconds at 260 ⁰ C.		

* see figure 5 to establish pulsed condition

ELECTRICAL / OPTICAL CHARACTERISTICS AT T_A=25⁰C

PARAMETER	SYMBOL	MIN.	TYP.	MAX.	UNIT	TEST CONDITION
Average Luminous Intensity	I _v	200	600		μcd	I _F =1mA
			3400		μcd	I _F =5mA
Peak Emission Wavelength	λ _p		660		nm	I _F =20mA
Spectral Line Half-Width	Δλ		35		nm	I _F =20mA
Dominant Wavelength	λ _d		638		nm	I _F =20mA
Forward Voltage Per Segment	V _F		1.6	2.4	V	I _F =1mA
			1.7			I _F =5mA
			1.8			I _F =20mA
Reverse Current Per Segment	I _R			100	μA	V _R =5V
Luminous Intensity Matching Ratio	I _v -m			2:1		I _F =10mA

Note: Luminous intensity is measured with a light sensor and filter combination that approximates the CIE (Commision Internationale DE L'Eclairage) eye-response curve.

TYPICAL ELECTRICAL / OPTICAL CHARACTERISTIC CURVES

(25°C Ambient Temperature Unless Otherwise Noted)

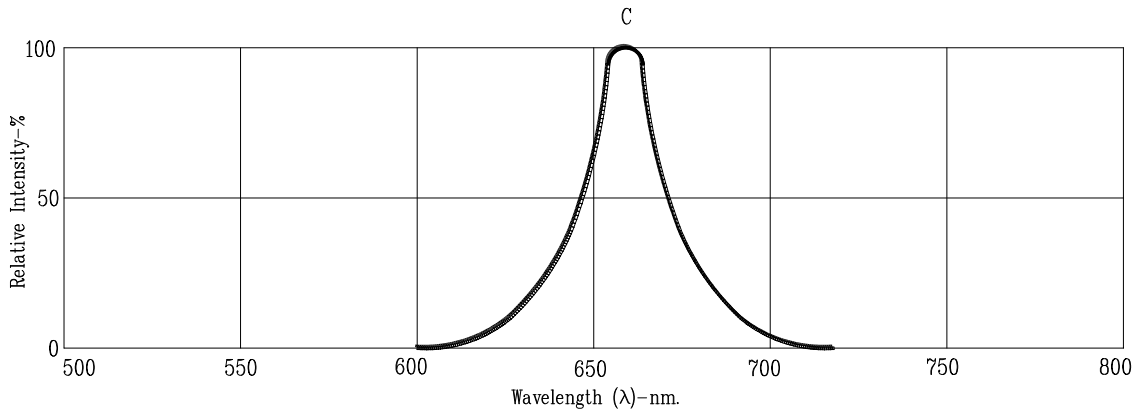

Fig1. RELATIVE INTENSITY VS. WAVELENGTH

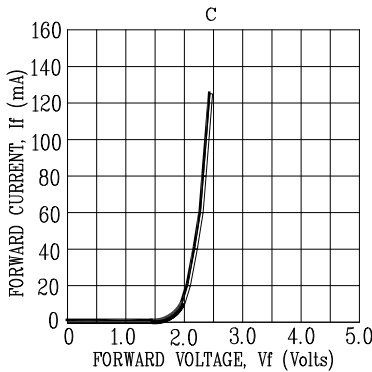

Fig2. Forward Current vs. Forward Voltage

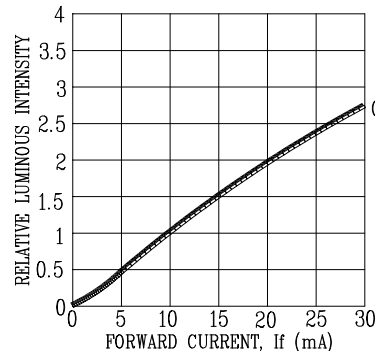

Fig3. Relative Luminous Intensity vs. DC Forward Current

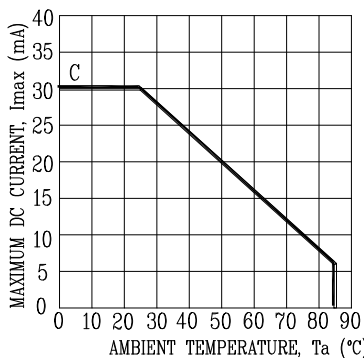

Fig4. Maximum Allowable DC Current vs. Ambient Temperature

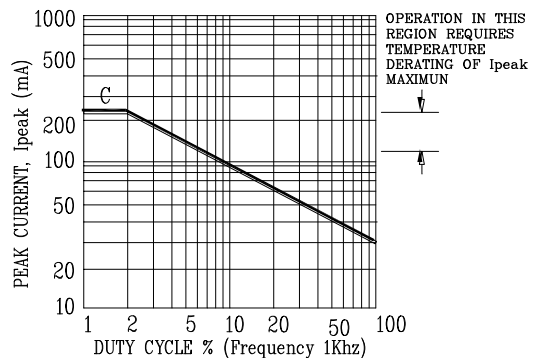

Fig5. Maximum Peak Current vs. Duty Cycle %

NOTE: C=AlGaAs RED

Mouser Electronics

Authorized Distributor

Click to View Pricing, Inventory, Delivery & Lifecycle Information:

[Lite-On:](#)

[LTS-2301AWC](#)