

Product Data Sheet 4412F/2GP-535

ebmpapst

Die Wahl der Ingenieure



4412F/2GP-535

INDEX

1	General	3
2	Mechanics	3
2.1	General	3
2.2	Connections	3
3	Operating Data	5
3.1	Operating Data - Electrical Interface - Input	5
3.2	Electrical Operating Data	7
3.3	Operating Data - Electrical Interface - Output	8
3.4	Electrical Features	9
3.5	Aerodynamics	10
3.6	Sound Data	11
4	Environment	11
4.1	General	11
4.2	Climatic Requirements*)	11
5	Safety	12
5.1	Electrical Safety	12
5.2	Approval Tests	12
6	Reliability	12
6.1	General	12

1 General

Fan type	Axial fan	
Rotating direction looking at rotor	Counterclockwise	
Airflow direction	Air outlet over struts	
Bearing system	Sleeve bearing	
Mounting position	Any	

2 Mechanics**2.1 General**

Width	119,0 mm	
Height	119,0 mm	
Depth	25,4 mm	
Mass	0,175 kg	
Housing material	Plastic	
Impeller material	Plastic	
Max. torque when mounted across both mounting flanges	wire outlet corner: 40 Ncm remaining corners: 10 Ncm	
Screw size	ISO 4762 - M4 degreased, without an additional brace and without washer	

2.2 Connections

Electrical connection	Wires - Plug	
Lead wire length	L = 325 mm	
Tolerance	+ - 10,0 mm	
Wire size (AWG)	24	
Insulation diameter	1,55 mm	
Contact	See drawing	

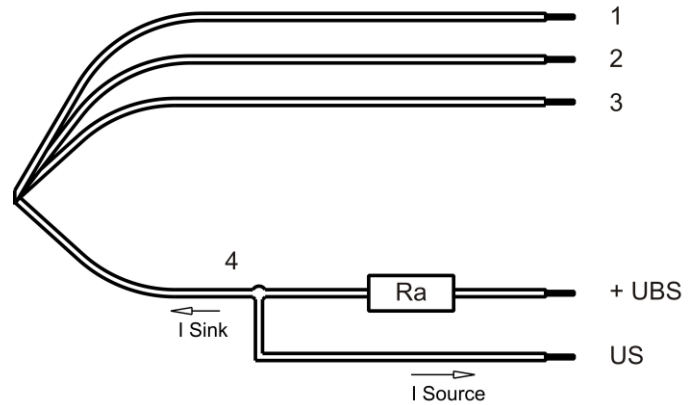

	Colour	Operation
Wire 1	red	+ UB
Wire 2	blue	- GND
Wire 3	violet	PWM
Wire 4	white	Tacho

The auxiliaries shown on the schematic diagram (which are required for the intended use) are not part of our delivery.

3 Operating Data

3.1 Operating Data - Electrical Interface - Input

Control input	PWM
---------------	-----

Features

Inpute type	Open collector	
PWM - Frequency		21 kHz - 28 kHz Typical: 25 kHz
Max. voltage for logic "Low"		0,8 V
Max. voltage for logic "High"	Open circuit voltage	5,25 V
Maximum source current	short circuit current	5 mA
4 wire startup condition	PWM duty cycle	> 20 %
4 wire operation condition after startup	PWM duty cycle	10 % - 100 %
PWM not applicable	PWM n.a.	0 % - 10 %

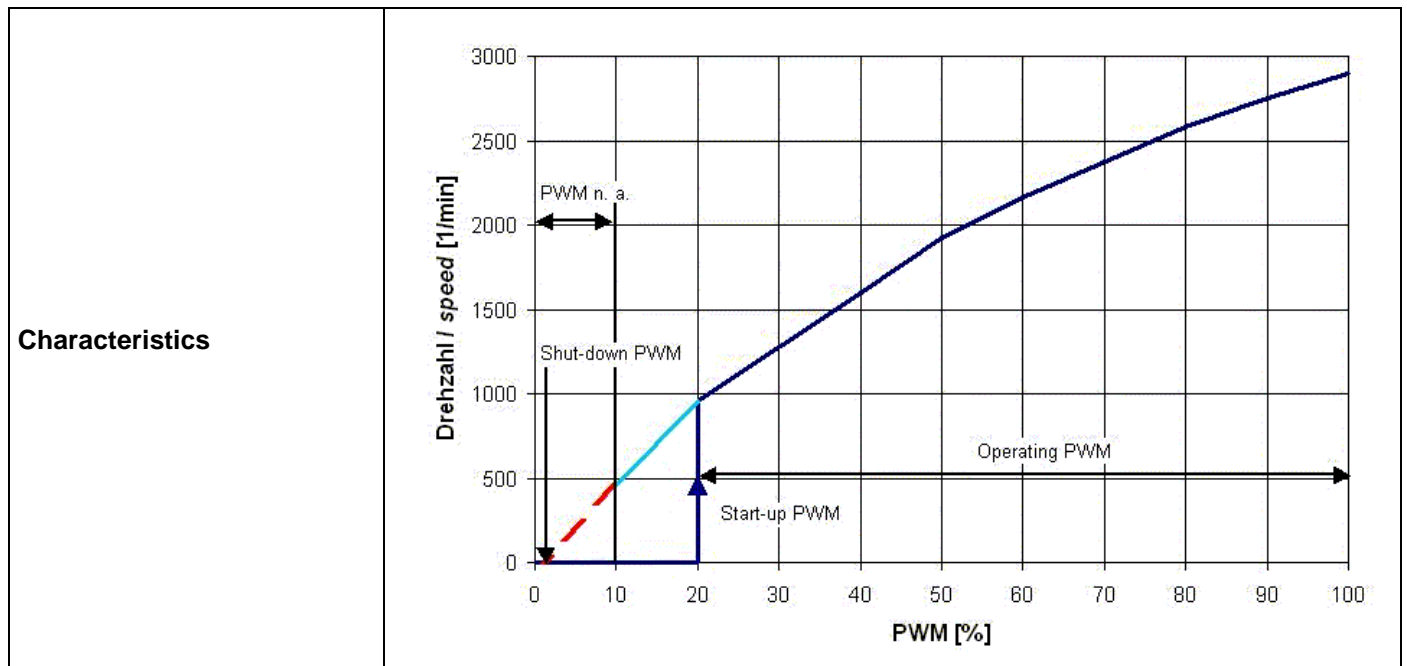

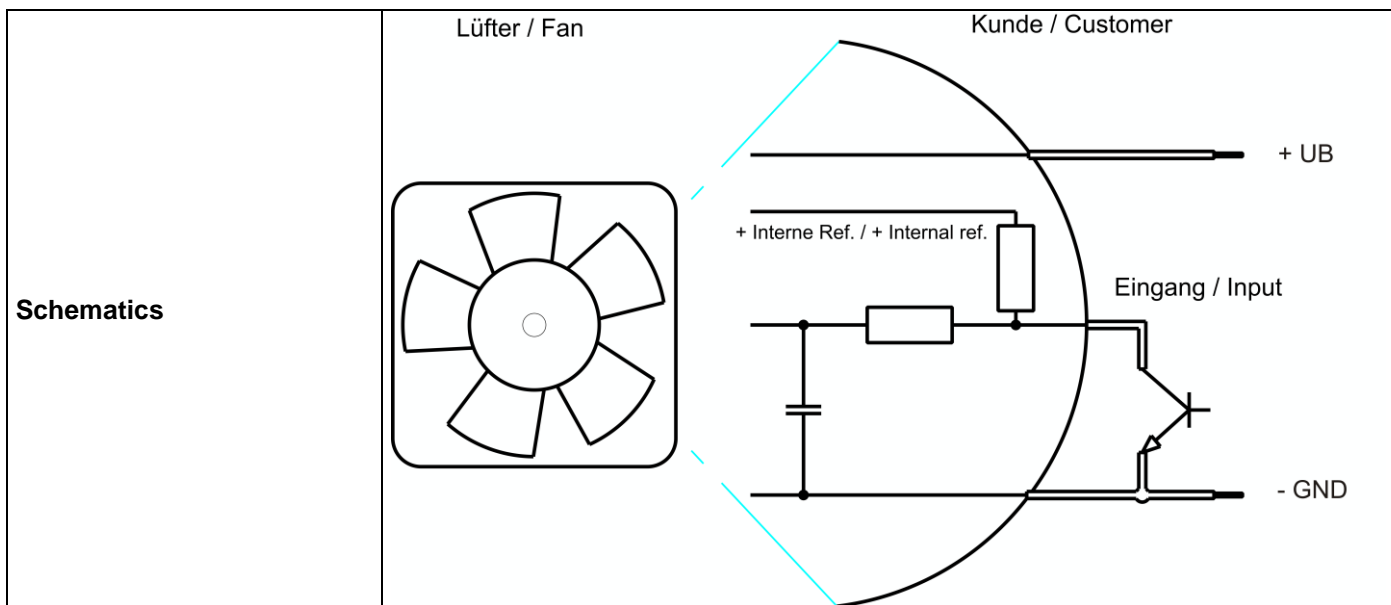

3.2 Electrical Operating Data

Measurement conditions: Normal air density = 1,2 kg/m³; Temperature 23°C +/- 3°C; Motor axis horizontal; warm-up time before measuring 5 minutes (unless otherwise specified). In the intake and outlet area should not be any solid obstruction within 0,5 m.

$\Delta p = 0$: corresp. to free air flow (see section 3.5)
 I: corresp. to arithm. mean current value

Name	Condition		
PWM 0001	PWM: 100 %;	f: 21 kHz	f: 25 kHz

Features	Condition	Symbol	Values		
Voltage range	$\Delta p = 0$	U	10,8 V		12,6 V
Nominal voltage	$\Delta p = 0$	U_N		12,0 V	
Power consumption	$\Delta p = 0$	P	5,2 W	6,5 W	7,2 W
Tolerance	PWM 0001		+/- 17,5 %	+/- 12,5 %	+/- 15,0 %
Current consumption	$\Delta p = 0$	I	480 mA	545 mA	570 mA
Tolerance	PWM 0001		+/- 17,5 %	+/- 12,5 %	+/- 15,0 %
Speed	$\Delta p = 0$	n	2.650 1/min	2.900 1/min	3.000 1/min
Tolerance	PWM 0001		+/- 12,5 %	+/- 7,5 %	+/- 10,0 %
Starting current consumption				<= 1.200 mA	

Name	Condition		
PWM 0002	PWM: 50 %;	f: 21 kHz	f: 25 kHz

Features	Condition	Symbol	Values		
Voltage range	$\Delta p = 0$	U	10,8 V		12,6 V
Nominal voltage	$\Delta p = 0$	U_N		12,0 V	
Power consumption	$\Delta p = 0$	P	1,6 W	2,0 W	2,2 W
Tolerance	PWM 0002		+/- 17,5 %	+/- 12,5 %	+/- 15,0 %
Current consumption	$\Delta p = 0$	I	145 mA	165 mA	175 mA
Tolerance	PWM 0002		+/- 17,5 %	+/- 12,5 %	+/- 15,0 %
Speed	$\Delta p = 0$	n	1.750 1/min	1.950 1/min	2.050 1/min
Tolerance	PWM 0002		+/- 12,5 %	+/- 7,5 %	+/- 10,0 %

3.3 Operating Data - Electrical Interface - Output

Tacho type	/2 (open collector)
------------	---------------------

Signal-Ausgangsspannung / Signal output voltage

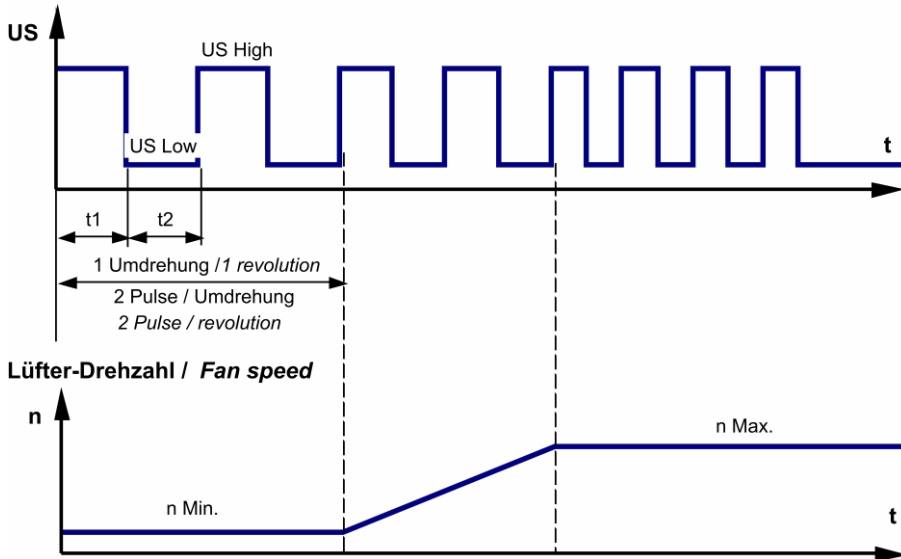

$$R_a = \frac{U_{BS} - U_{S\ Low}}{I_{Sink}}$$

Features	Note	Values
Tacho operating voltage (UBS)		<= 30,0 V
Tacho signal Low	I sink: 2 mA	<= 0,4 V
Tacho signal High	I source: 0 mA	30,0 V
Maximum sink current		<= 4 mA
External resistor	External resistor Ra from UBS to US required. All voltages measured to GND.	
Tacho frequency	(2 x n) / 60	
Tacho isolated from motor	No	
Slew rate		=> 0,5 V/us

Alarm type	None
------------	------

3.4 Electrical Features

Electronic function	Speed-Controlled	
Reversed polarity protection Max. residual current at U_n	Rectifying diode $I_F \leq 100 \mu\text{A}$	
Locked rotor protection	Auto restart	
Locked rotor current at U_n	approx. 1.200 mA	
Clock signal t_3/t_4 at locked rotor	Typical: 1,9 s / 8,2 s t_3 : 0,8 s... 4,7 s t_4 : 2,8 s... 27,0 s	

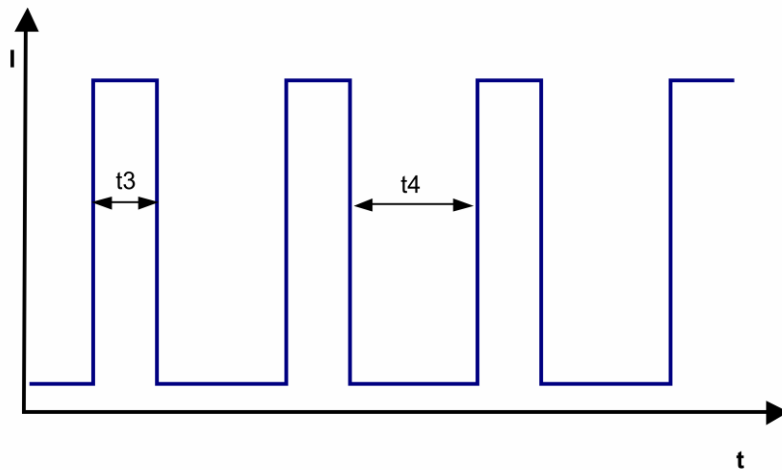

3.5 Aerodynamics

Measurement conditions:

Measured with a double chamber intake rig acc. to DIN EN ISO 5801.
 Normal air density = 1,2 kg/m³; Temperature 23°C +/- 3°C;
 In the intake and outlet area should not be any solid obstruction within 0,5 m.
 The information is only valid under the specified test conditions and may be changed by the installation conditions. If there are deviations from the standard test conditions, the characteristic values must be checked under the installed conditions.

a.) Operation condition:

2.900 1/min at free air flow	PWM 100 %;	f: 21 kHz	f: 25 kHz
------------------------------	------------	-----------	-----------

Max. free-air flow ($\Delta p = 0 / \dot{V} = \text{max.}$)	168,0 m ³ /h	
Max. static pressure ($\Delta p = \text{max.} / \dot{V} = 0$)	67 Pa	

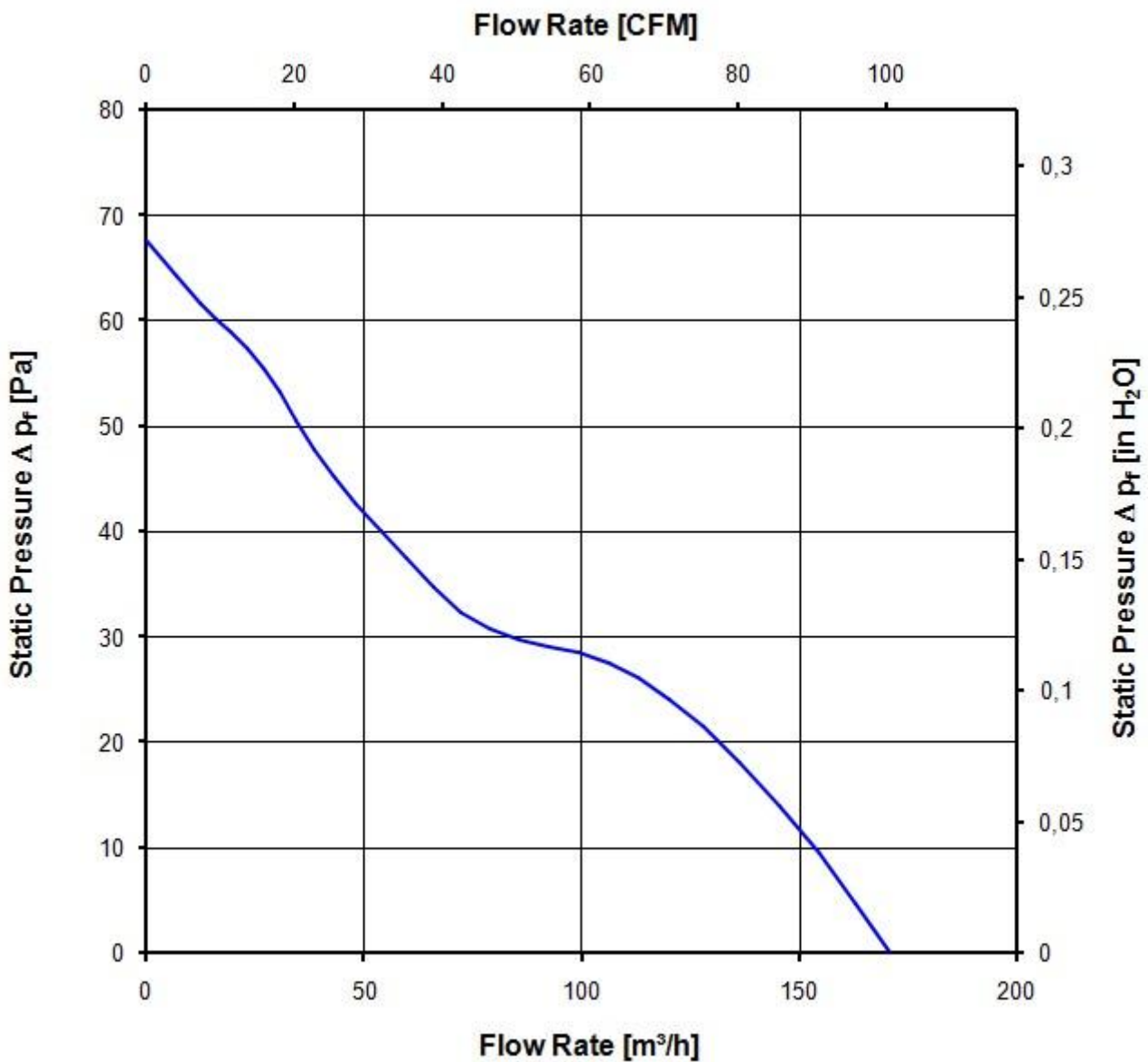

3.6 Sound Data

Measurement conditions: Sound pressure level: 1 Meter distance between microphone and the air intake.
 Sound power level: Acc. to DIN 45635 part 38 (ISO 10302)
 Measured in a semianchoic chamber with a background noise level of $L_p(A) < 5 \text{ dB(A)}$
 For further measurement conditions see section 3.5

a.) Operation condition:

2.900 1/min at free air flow	PWM 100 %	PWM min.: ; f: 21 kHz	PWM max.:; f: 25 kHz
------------------------------	-----------	-----------------------	----------------------

Optimal operating point	124,0 m3/h @ 19 Pa	
Sound power level at the optimal operating point	5,4 bel(A)	
Sound pressure level at free air flow, measured in rubber bands	43,0 dB(A)	

4 Environment

4.1 General

Min. permitted ambient temperature TU min.	-20 °C	
Max. permitted ambient temperature TU max.	60 °C	
Min. permitted storage temperature TL min.	-40 °C	
Max. permitted storage temperature TL max.	80 °C	

4.2 Climatic Requirements *)

Humidity requirements	humid heat, constant; according to DIN EN 60068-2-78, 14 days	
Water exposure	None	
Dust requirements	None	
Salt fog requirements	None	

*) Permitted application area:

The product is intended for use in sheltered rooms with controlled temperature and controlled humidity. Directly exposure to water must be avoided.

Pollution degree 1 (according DIN EN 60664-1)

There is either no pollution or it occurs only dry, non-conductive pollution. The pollution has no negative impact.

5 Safety

5.1 Electrical Safety

Dielectric strength DIN EN 60950 (VDE 0805) and DIN EN 60335 (VDE 0700) A.) Type test Measuring conditions: After 48h of storage at 95% R.H. and 25°C. No arcing or breakdown is allowed! All connections together to ground. B.) Routine test Measuring conditions: At indoor climate. No arcing or breakdown is allowed! All connections together to ground.	500 VAC / 1 Min. 500 VAC / 1 Sec.	
Isolation resistance Measuring conditions: After 48h of storage at 95% R.H. and 25°C measured with U=500 VDC for 1 min.	RI > 10 MOhm	
clearance / creepage distance	1,0 mm / 1,2 mm	
Protection class	III	

5.2 Approval Tests

CE	EC Declaration of Conformity	No
EAC	Eurasian Conformity	Yes
UL	Underwriters Laboratories	Yes / UL507, Electric Fans
VDE	Association for Electrical, Electronic and Information Technologies	Yes / Approval acc. to EN 60950 (VDE 0805) - Information technology equipment
CSA	Canadian Standards Association	Yes / C22.2 No. 113 Fans and Ventilators
CCC	China Compulsory Certification	No

6 Reliability

6.1 General

Life expectancy L10 at TU = 40 °C	60.000 h	
Life expectancy L10 at TU max.	37.500 h	
Life expectancy L10 IPC (40 °C)	102.500 h	

Copying of this document, and giving it to others and the use or communication of the contents thereof, are prohibited without the written consent of the manufacturer. All rights are reserved in the event of the grant of a patent, or the registration of a utility model or design.

Schutzrecht nach DIN ISO 9016 beachten/
 Refer to protection notice DIN ISO 9016!

Steckergehäuse
 47054-1000 Fa. Molex
 Kontakt
 08-56-0109 Fa. Molex
 Steckerbelegung:
 PIN 1 = blau (-)
 PIN 2 = rot (+)
 PIN 3 = weiß (Tacho)
 PIN 4 = violett (PWM)

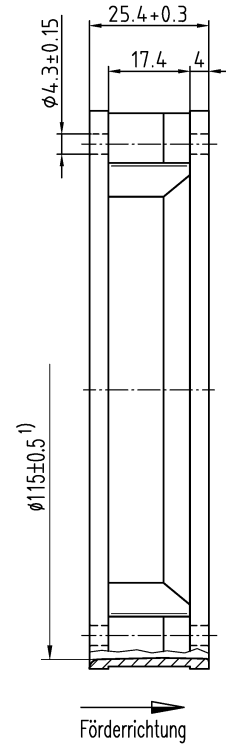
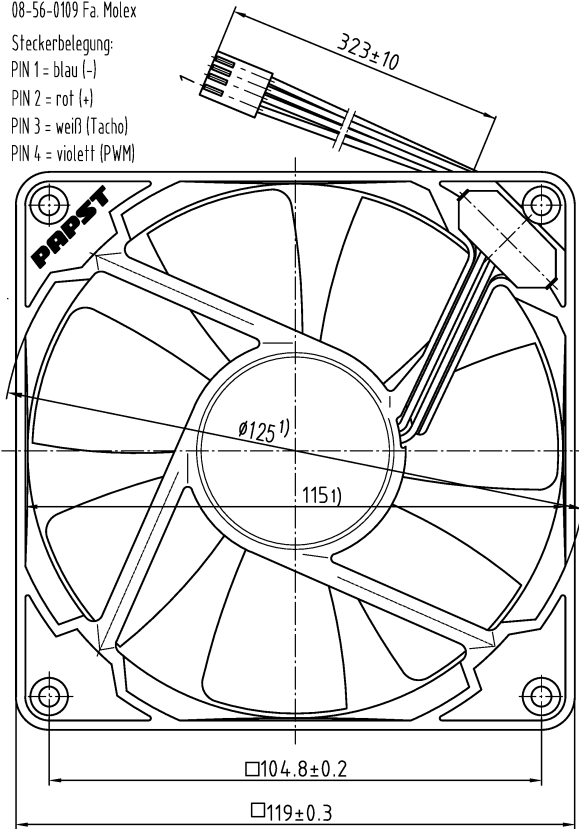

Axialspiel bei Kugellagerung (K) : 0 (mit Federausgleich)
 Axialspiel bei Gleitlagerung (G) : 0.1 - 0.6
 1) Maße für Montagewand

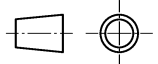
Tolerierung/Tolerances: DIN 7167			
Allgemeintoleranzen/ Gen. Tolerances:		DIN ISO 2768-mK-E	
		Artikel/Title	
		Massstab/scale	
Datum/Date		Name/Name	
Bearb./Drawn:			
Index/Index		Aend.-Nr./Change-No.	
gepr. u. zur Verwendung freigegeben/Checked for release von/am by/on		 ebmpapst Zchg.-Nr. / Dwg.-No.: Ers.f.Zchg./ Replaces:	
ebm-papst St. Georgen GmbH & Co. KG		Blatt/Page	
		A4	

Mouser Electronics

Authorized Distributor

Click to View Pricing, Inventory, Delivery & Lifecycle Information:

[ebm-papst:](#)

[4412F/2GP-535](#)