

**Model 72960
SMA PLUG R/A CRIMP, RG142, 400**



Model 72960 SMA PLUG R/A CRIMP, RG142, 400

High bandwidth, small size, and durability for confident connections

Features

- DC – 12.4 GHz
- Meets MIL-C-39012, IEC 169-15, CECC 22110.
- Small size and durability for mobile communications.
- Precision machined and gold-plated for low loss.

Materials

- Body is machined brass with gold plating.
- Center Contacts - Plug is gold plated brass and Jack is gold plated Beryllium copper.
- Insulators are high quality PTFE.
- Crimp Ferrules are copper with gold or nickel plating.
- Gaskets are silicone rubber.

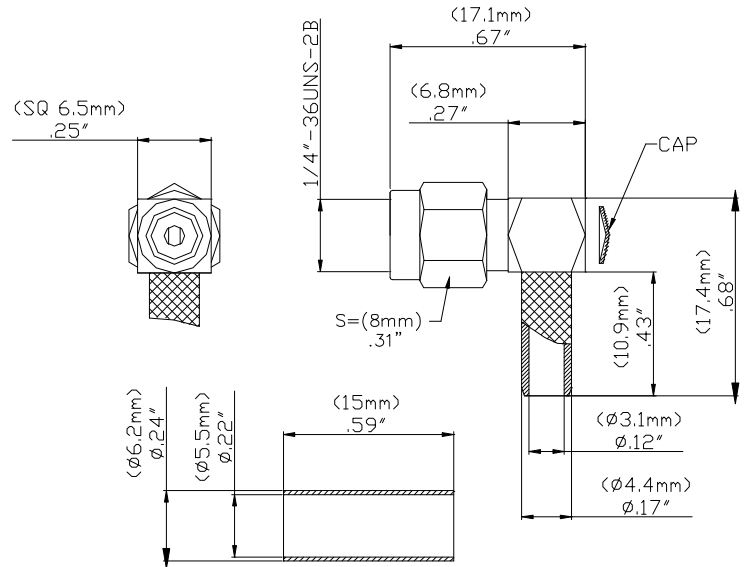

Specifications

Impedance	50 Ω
Frequency Range	DC – 12.4 GHz max.
Working Voltage	< 500 V _{peak}
Dielectric Withstanding Voltage	1,000 V _{rms}
VSWR	1.4 max.
Center/Outer Contact Resistance	0.003/0.002 Ω max
Insulation resistance	> 5000 MΩ
Number of Insertions	500 cycles minimum
Temperature Range	-65° C to 165° C, -85° F to 329° F

Ordering Information

Model: 72960
Description: SMA PLUG R/A CRIMP, RG142, 400

USA: Sales: 800-490-2361
Technical Support: technicalsupport@pomonatest.com
Fax: 425-446-5844

Europe: 31-(0) 40 2675 150 International: 425-446-5500

Where to Buy: www.pomonaelectronics.com

All dimensions are in inches. Tolerances (except noted): .xx = ±.02" (.51 mm), .xxx = ±.005" (.127 mm). All specifications are to the latest revisions. Specifications are subject to change without notice. Registered trademarks are the property of their respective companies.
D2003395 REV 001

Model 72960
SMA PLUG R/A CRIMP, RG142, 400

Cable Types and Crimp Die Information

Connector Model #	Cable Groups	Crimp Die Cavity Size for Outer Ferrule
72960	RG 142, 400	.230 (5.9)

Cable Assembly Instructions

1. CUT CABLE END EVENLY AND PERPENDICULAR

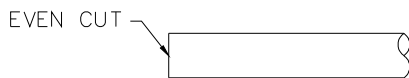

2. SLIDE OUTER FERRULE OVER CABLE END.

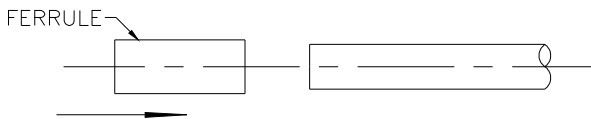

3. STRIP CABLE JACKET, BRAID, AND DIELECTRIC TO SPECIFICATION LENGTHS.

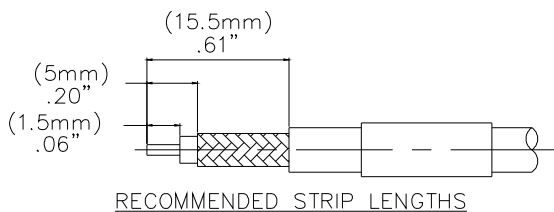

4. FLARE BRAID END SLIGHTLY.

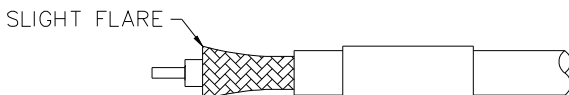

5. SLIDE CONNECTOR BODY OVER CENTER CONTACT AND SLIDE OUTER FERRULE OVER BRAID AND UP AGAINST BODY ASSEMBLY.

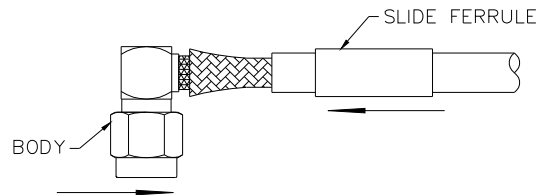

6. PRESS CAP AS SHOWN INTO CONNECTOR BODY. SLIDE OUTER FERRULE OVER BRAID AND UP AGAINST BODY ASSEMBLY.

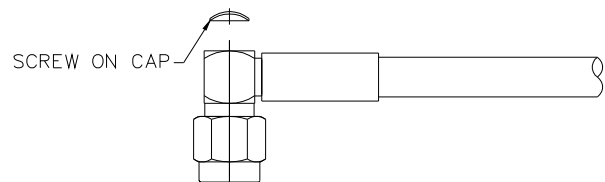

7. CRIMP OUTER FERRULE WITH APPROPRIATE CRIMP TOOL.

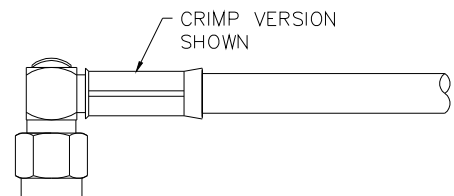

USA: Sales: 800-490-2361
 Technical Support: technicalsupport@pomonatest.com
 Fax: 425-446-5844
Europe: 31-(0) 40 2675 150 **International:** 425-446-5500
Where to Buy: www.pomonaelectronics.com

All dimensions are in inches. Tolerances (except noted): .xx = ±.02" (.51 mm), .xxx = ±.005" (.127 mm). All specifications are to the latest revisions. Specifications are subject to change without notice. Registered trademarks are the property of their respective companies.
 D2003395 REV 001

Mouser Electronics

Authorized Distributor

Click to View Pricing, Inventory, Delivery & Lifecycle Information:

[Pomona:](#)

[72960](#)