

24 V 25 W PD with Isolated Flyback Converter Evaluation

Introduction

Microchip's EV18R03A evaluation board (see [Figure 2](#)) provides designers with the environment needed for evaluating the performance and implementation of low-profile PD applications based on the PD70201 device.

The board uses a single PD device, PD70201ILQ, to support the detection, classification, and powering phases on the 2/4 pairs of the Cat5 cable, and implements DC-DC converter with a planar transformer. PD70201ILQ supports a standard IEEE[®] 802.3af and IEEE 802.3at Type 2 interface. This document provides all the necessary steps and connection instructions required to install and operate this board. The EV18R03A evaluation board supports a 25 W at 24 V output. The following figure shows the EV18R03A block diagram.

Figure 1. EV18R03A Block Diagram

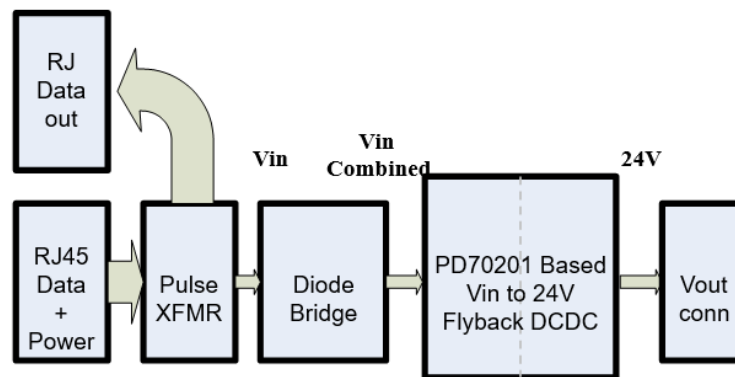
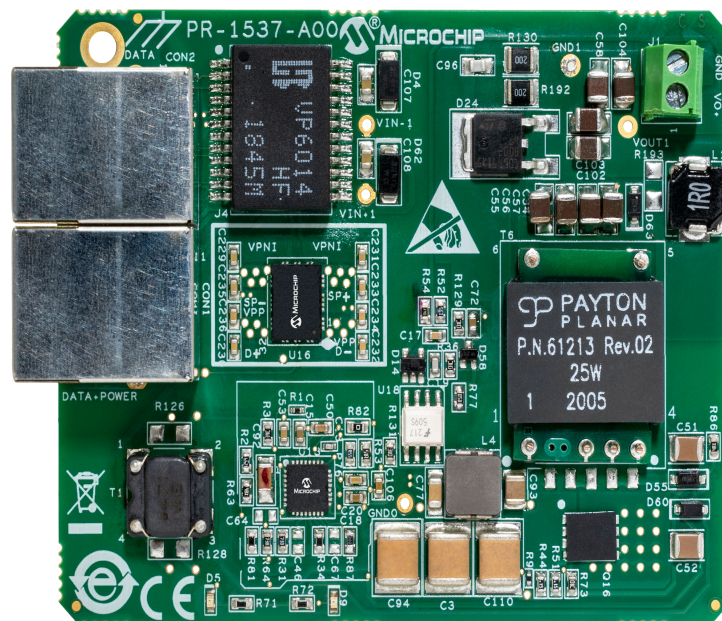

Figure 2. EV18R03A Evaluation Board—General View



Microchip's PD70201ILQ device is part of a family of devices that are targeted for realizing the IEEE 802.3at standard PD interface. The following table lists the PD interface family of devices.

Table 1. PoE PD Devices

P/N	Type	Package	IEEE 802.3af Support	IEEE 802.3at Support	HDBaseT Support	UPoE Support
PD70100	Front end	3 mm x 4 mm 12L DFN	x	—	—	—
PD70101	Front end + PWM	5 mm x 5 mm 32L QFN	x	—	—	—
PD70200	Front end	3 mm x 4 mm 12L DFN	x	x	—	—
PD70201	Front end + PWM	5 mm x 5 mm 32L QFN	x	x	—	—
PD70210	Front end	4 mm x 5 mm 16L DFN	x	x	x	x
PD70210A	Front end	4 mm x 5 mm 16L DFN	x	x	x	x
PD70210AL	Front end	5 mm x 7 mm 38L QFN	x	x	x	x
PD70211	Front end + PWM	6 mm x 6 mm 36L MLPQ	x	x	x	x
PD70224	Ideal Diode Bridge	7.5 mm x 10 mm 52L MLP	x	x	x	x

Table of Contents

Introduction.....	1
1. Overview.....	4
1.1. Ordering Information.....	4
1.2. Evaluation Board Features.....	4
1.3. Physical Characteristics.....	4
2. Physical Description.....	5
2.1. Package Contents.....	5
2.2. Connectors.....	5
2.3. Indications.....	7
3. Electrical Characteristics.....	8
4. Installation.....	9
4.1. Preliminary Considerations and Safety Precautions.....	9
4.2. Initial Configuration.....	9
5. Board Test Waveforms.....	10
6. Efficiency.....	14
6.1. Efficiency for 48 V Input at Input Connector.....	14
7. Schematic.....	15
8. Bill of Materials.....	16
9. Board Layout.....	20
10. Reference Documents.....	22
11. Revision History.....	23
The Microchip Website.....	24
Product Change Notification Service.....	24
Customer Support.....	24
Microchip Devices Code Protection Feature.....	24
Legal Notice.....	24
Trademarks.....	25
Quality Management System.....	25
Worldwide Sales and Service.....	26

1. Overview

The following sections provide an overview of the EV18R03A evaluation board.

1.1 Ordering Information

Microchip supplies the following list of evaluation boards.

Table 1-1. Microchip Evaluation Boards

Ordering Number	Description
EV18R03A	IEEE 802.3at Type 2 PD, based on PD70201 device, controls an isolated flyback converter and has a 24 V at 1.05 A output.

1.2 Evaluation Board Features

The following features are supported in the EV18R03A evaluation board.

- Support for data and spare current by a single PD70201 device
- Two RJ45 connectors (Data and Power In, Data Out)
- Output voltage connector
- On-Board Power Good LED indicator
- On-Board AT detected LED indicator
- Pulse transformer for routing the data to PD application to enable full PD evaluation
- Evaluation board working temperature: 0 °C to 50 °C
- RoHS compliant

1.3 Physical Characteristics

The following table lists the physical characteristics of the evaluation board.

Table 1-2. Physical Characteristics

Parameter	Value (mm)
Mechanical dimensions	81 x 65 x 8 (L x W x H ¹)

Note:

1. The height excluding input and output connectors.

2. Physical Description

The following sections provide the physical description of the EV18R03A evaluation board.

2.1 Package Contents

Package content for standard shipments: EV18R03A Evaluation Board.

If it is damaged, contact your local Microchip CEM or ESE.

2.2 Connectors

The following sections provide information about the unit's connectors.

2.2.1 Connectors Table

The following table lists the evaluation board's connectors.

Table 2-1. Connectors List

#	Connector	Name	Description
1	CON1	RJ45 Connector	RJ45 port for Data and Power In for PSE connection
2	CON2	RJ45 Connectors	RJ45 port for Data Out for PD data connection
4	J1	Converter Output	Terminal blocks for connecting a load to output regulator

2.2.2 Connectors Detailed Explanation

RJ45 Connectors

The following table lists the pin descriptions of the connectors listed in [Table 2-1](#).

Table 2-2. RJ45 Connectors

Connector	Pin Number	Signal Name	Description
CON2	1, 2, 3, 4, 5, 6, 7, and 8	Data Out	Data output to PD
CON1	1, 2, 3, 4, 5, 6, 7, and 8	Data and Power In	Data and power input to a powered device

The following figure shows the two dedicated RJ45 connectors.

Figure 2-1. Front RJ45

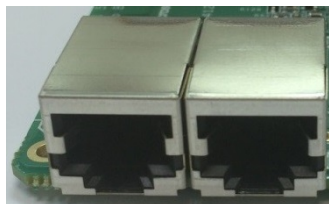

V_{out} Connectors

J1 is the DC/DC output connection used for connecting to an external load.

Pin Number	Signal Name	Description
J1 (Left)—Pin 1	V _{out}	Positive DC/DC output voltage
J1 (Right)—Pin 2	V _{out_Rtn}	Return of DC/DC output voltage

The following figure shows the details of the V_{out} connectors.

Figure 2-2. V_{out} Connectors

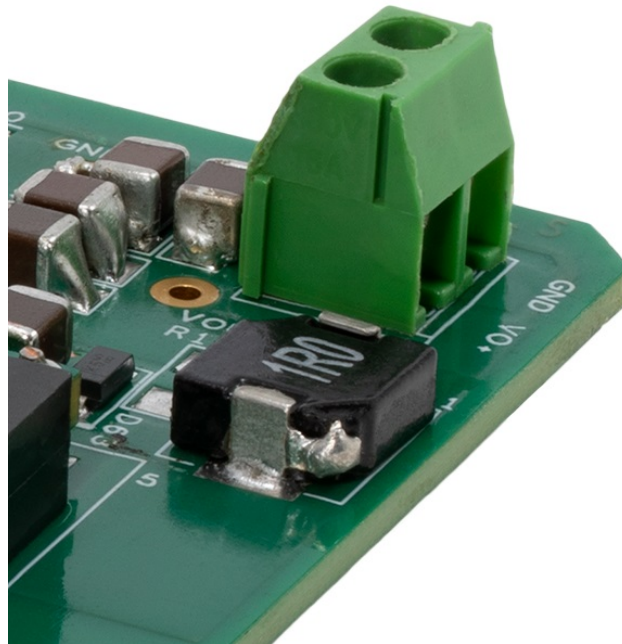

2.3 Indications

The following section provides general information about unit indications.

LED Indication

The following figure shows the LEDs on the evaluation board.

- D5 is the Power_GOOD indication LED. The PD70201 device output signal indicates if the device isolation switch is in operation. The PWM converter must be turned ON only after this signal is active.
- D9 is the AT flag indication LED. The PD70201 device output signal indicates that the device has detected two or more classification "fingers". Therefore, the PSE side is AT level capable. This signal is an indication to the PD environment that AT power level is supported.

Figure 2-3. LED Indications

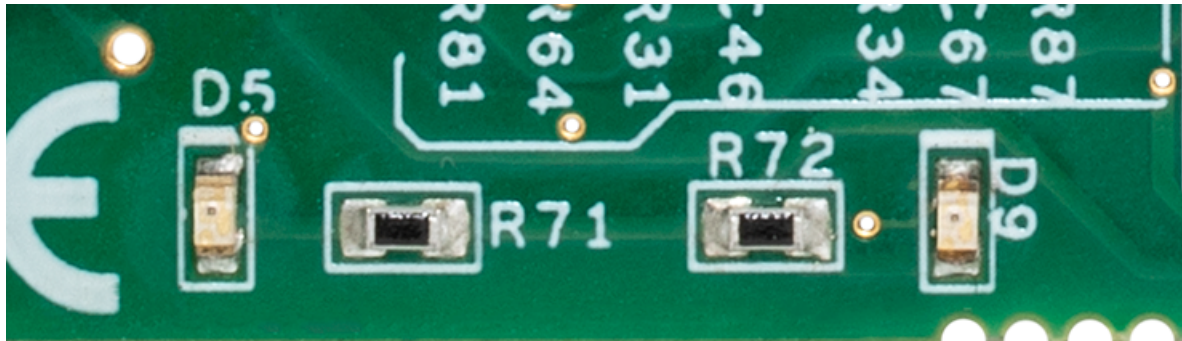

3. Electrical Characteristics

The following table lists the EV18R03A evaluation board's electrical characteristics.

Table 3-1. Electrical Characteristics

Parameter	Min	Max	Unit
Main DC supply—CON1 and J2	42	57	V
Maximum available current	24 V/1.05 A	—	A
Port isolation to chassis	—	1.5	kVrms

Note: Minimum load of 10 mA is required to keep 24 V output within the regulation band. The unit is not damaged without this minimum load, but output voltage can go up to 28 V.

4. Installation

The following sections describe the installation process of the EV18R03A evaluation board.

4.1 Preliminary Considerations and Safety Precautions

Verify if board's power supply is turned OFF before all peripheral devices are connected.

Note: In maximum power at the output, some of the devices might reach high temperatures (still less than 70 degrees). Attention must be paid while testing these devices.

4.2 Initial Configuration

Prior to starting any operation, verify that the evaluation board is setup, as shown in the following figure.

Perform the following steps to verify the board set up.

1. Connect load to main board (J1).
2. Connect a Cat 5 cable from PSE to the evaluation board (CON1). Alternatively, connect a power cable from the power supply to the evaluation board (J2).
3. When testing the Ethernet data, connect Ethernet cable from the evaluation board (CON2) to PD Ethernet host.

Figure 4-1. Test Setup

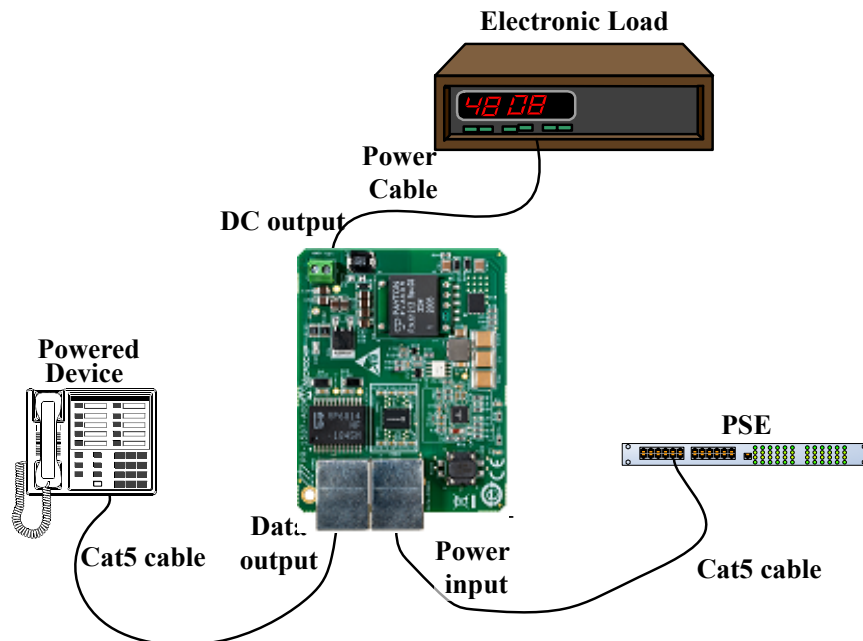

5. Board Test Waveforms

The following section shows snapshots of signals on the 24 V board. Waveforms were taken in Microchip's lab on a single board. Minor changes might be seen, based on test setup and device variance.

Figure 5-1. 24 V/25 W Flyback Output Voltage Ripple at Full Load

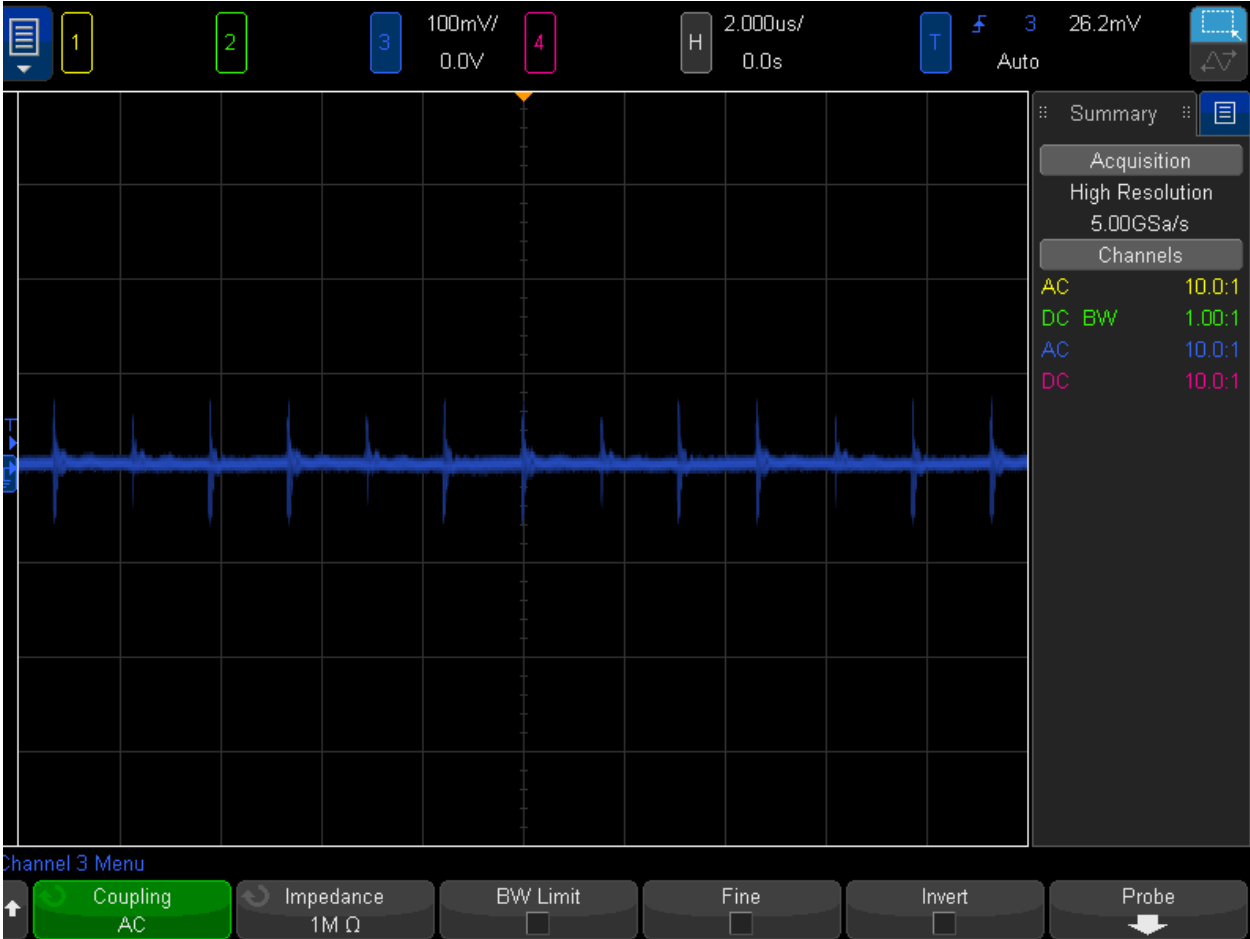

Output voltage ripple at full load: 150 mV peak-to-peak.

Figure 5-2. 24 V/25 W Flyback Output Voltage at Load Switching from 90% to 20%

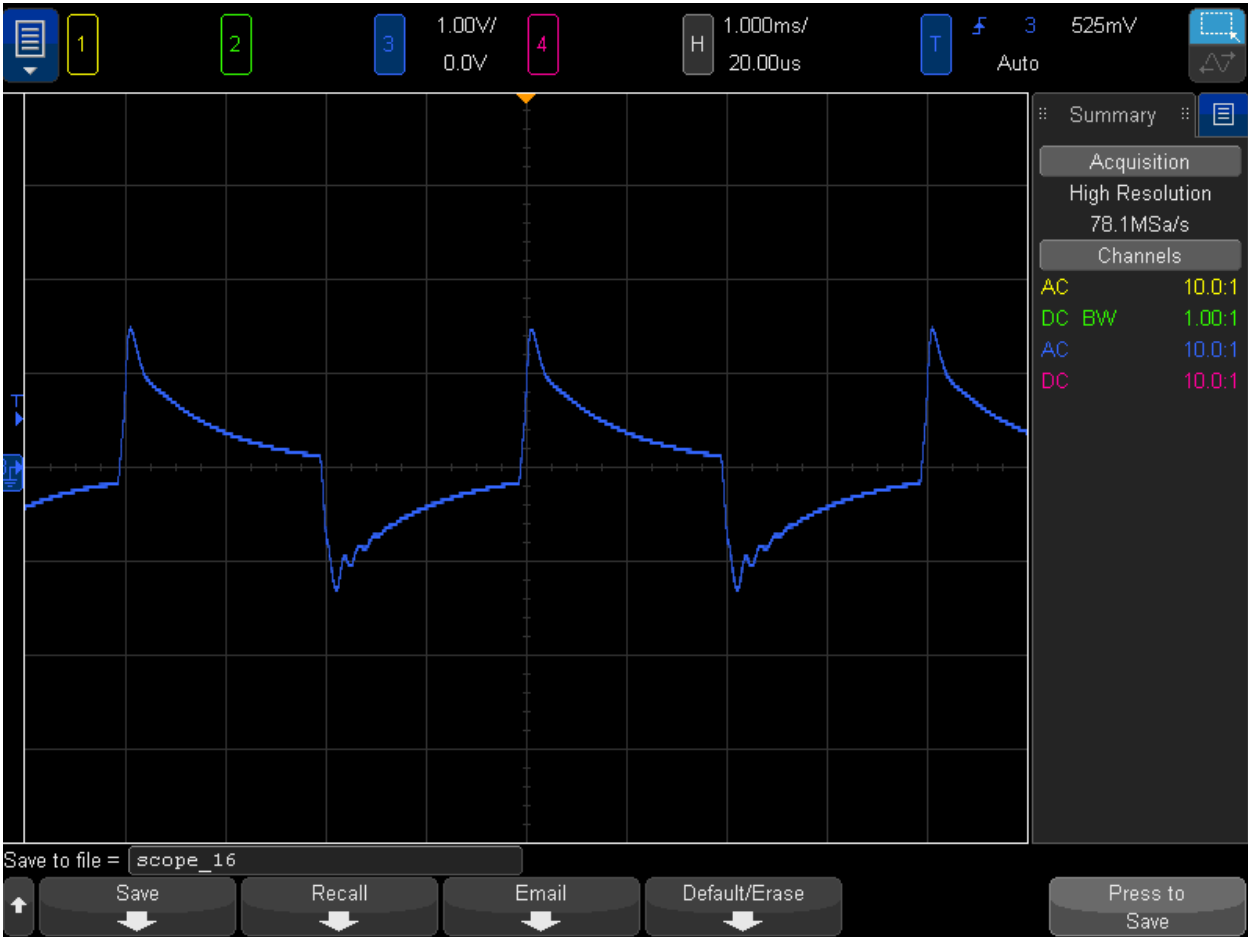
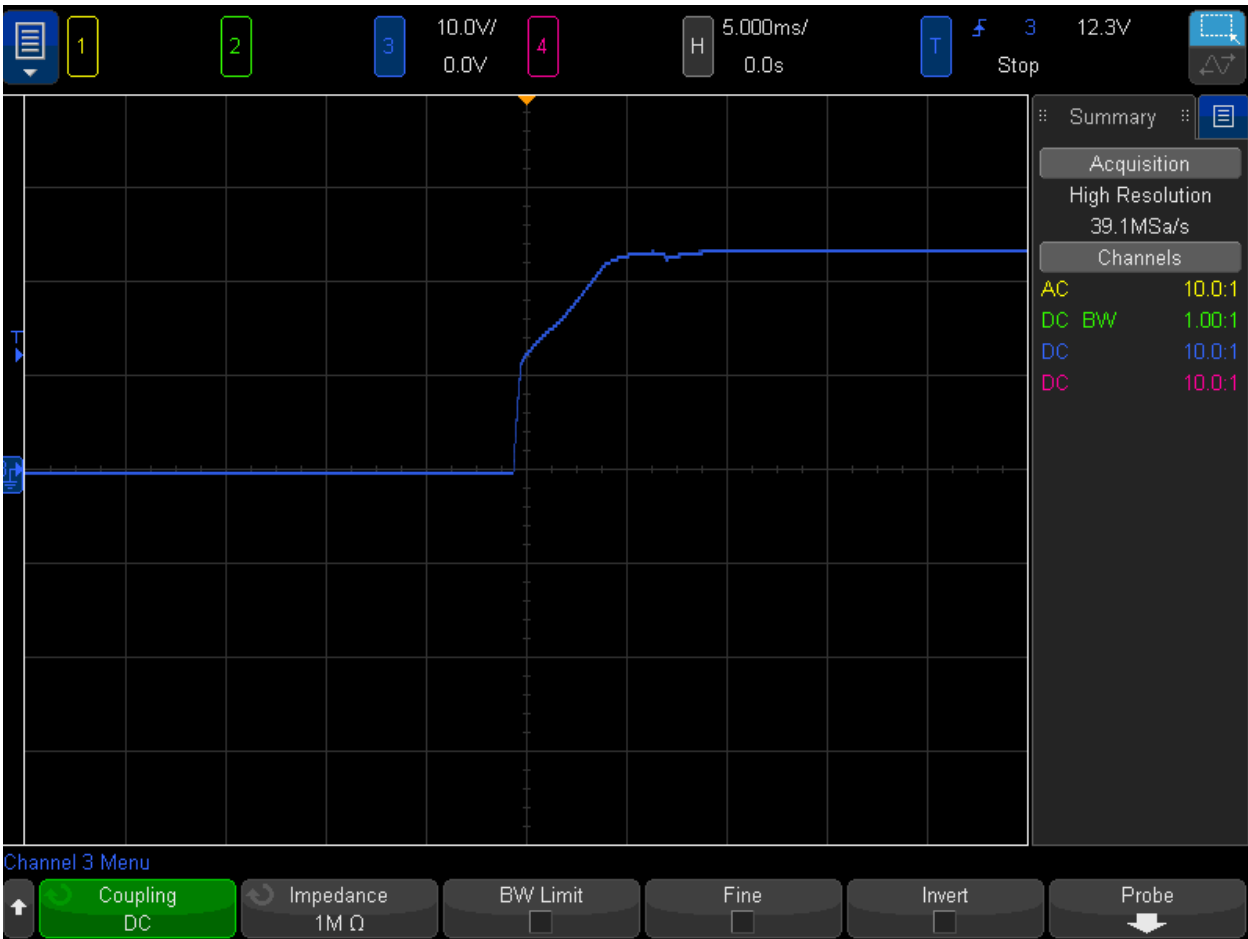
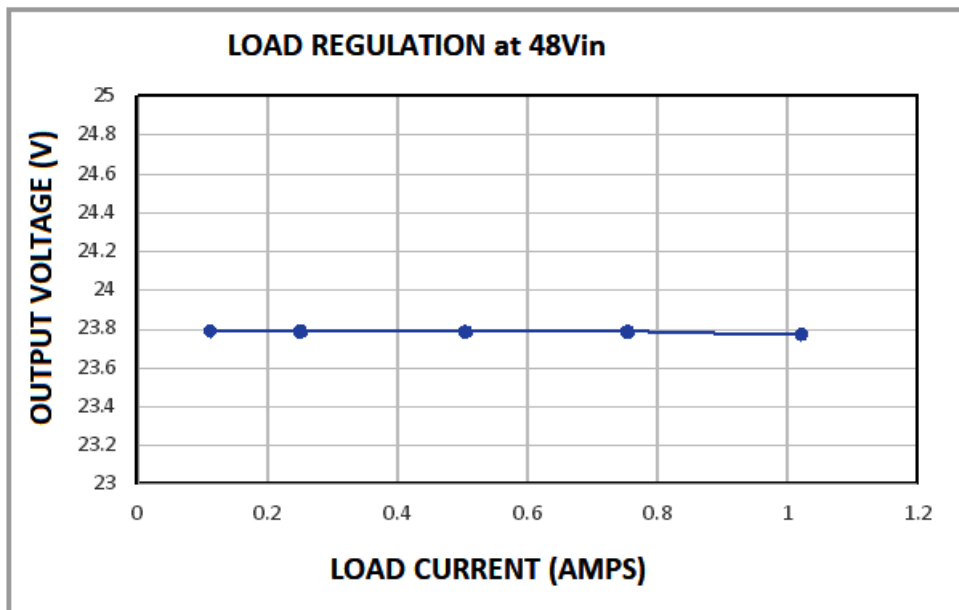

Figure 5-3. 24 V/25 W Output Voltage Initial Turn On at Full Load



The following figure shows the typical output voltage load regulation.

Figure 5-4. Output Voltage as a Function of Load Current



Note: The unit requires 10 mA minimum load to keep voltage within the regulation band $24\text{ V} \pm 2\%$. Without this minimum load, the output voltage might go out of the regulation band (up to 28 V).

6. Efficiency

The following section describes typical total EVB efficiency under various load levels.

Total efficiency is measured between RJ45 input connector and output voltage connector. It includes losses in rectifier bridge, but does not include losses in the connectors.

$$\text{Total Eff} = (V_{\text{out}} \cdot I_{\text{out}}) / (V_{\text{in}} \cdot I_{\text{in}})$$

6.1 Efficiency for 48 V Input at Input Connector

The following figure shows the EV18R03A efficiency at 48 V.

Figure 6-1. EV18R03A Efficiency at 48 V

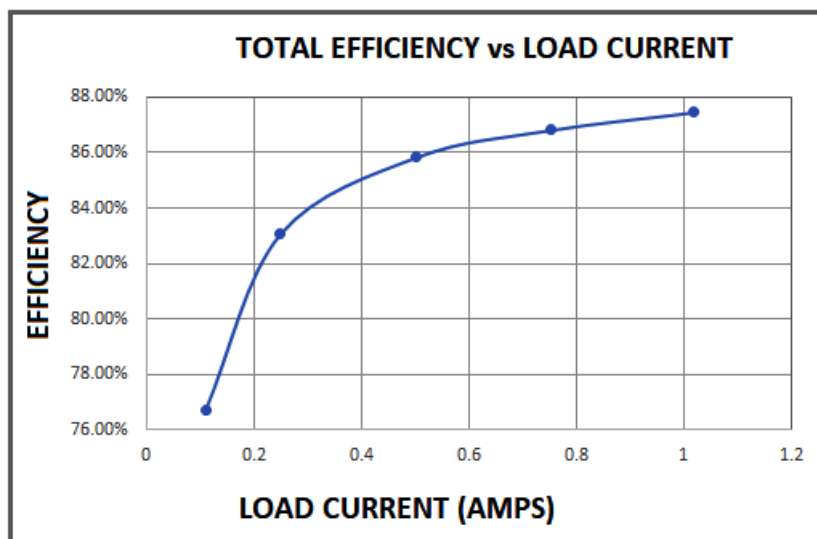

7. Schematic
Figure 7-1. Schematic

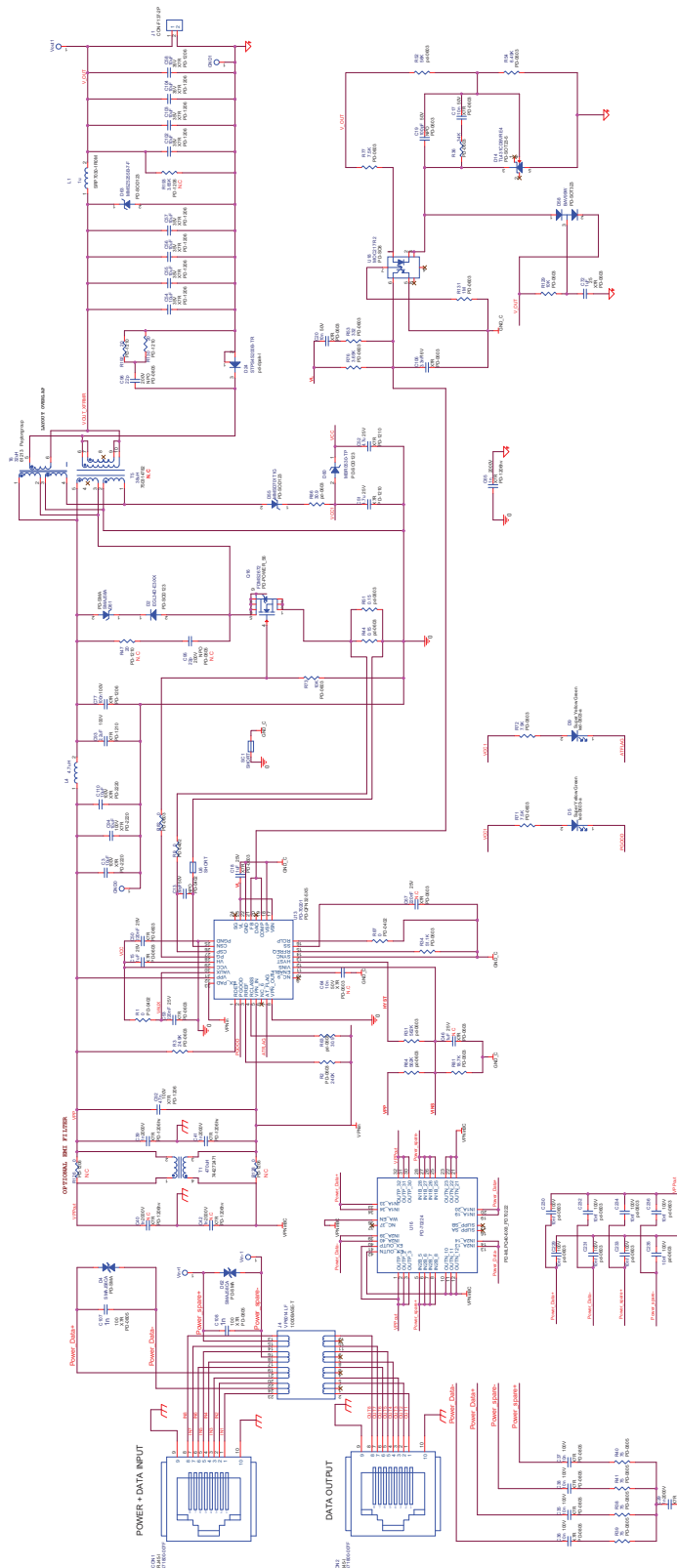

8. Bill of Materials

The following table lists the EV18R03A parts.

Table 8-1. EV18R03A Assembly

Item	Qty	Ref	VALUE	DESCRIPTION	Mfr. Part Number	Mfr. Name
1	2	CON1	RJ45	CON RJ45 SINGLE 8 POS. SHIELDED	SS71800-007F	Bel Stewart
—	—	CON2	RJ45	CON RJ45 SINGLE 8 POS. SHIELDED	SS71800-007F	Bel Stewart
2	3	C3	10 µF	CAP CRM 10 µF 100 V 20% X7R 2220	22201C106MAT2A	AVX
—	—	C94	10 µF	CAP CRM 10 µF 100 V 20% X7R 2220	22201C106MAT2A	AVX
—	—	C110	10 µF	CAP CRM 10 µF 100 V 20% X7R 2220	22201C106MAT2A	AVX
3	1	C13	39 pF	CAP CRM 39PF 50V 5% C0G 0402	GRM1555C1H390JZ01D	Murata
4	3	C15	1 µF	CAP CRM,X7R 1 µF 25 V 10% 0603	GRM188R71E105KA12D	Murata
—	—	C18	1 µF	CAP CRM X7R 1 µF 25 V 10% 0603	GRM188R71E105KA12D	Murata
—	—	C46	1 µF	CAP CRM X7R 1µF 25 V 10% 0603	GRM188R71E105KA12D	Murata
5	2	C17	10 n	CAP CRM 10 nF 50 V 10% X7R 0603 SMT	MCH185CN103KK	Rohm
—	—	C20	10 n	CAP CRM 10 nF 50 V 10% X7R 0603 SMT	MCH185CN103KK	Rohm
6	1	C19	100 pF	CAP COG 100 pF 50 V 5% 0603	C1608C0G1H101J	TDK
7	1	C29	1 n	CAP CRM 1 nF/2000 V 10% X7R 1206 SMT	1206GC102KAT1A	AVX
8	4	C35	10 n	CAP CRM 10 nF 100 V 5% X7R 0805 SMT	C0805C103J1RAC	Kemet
—	—	C36	10 n	CAP CRM 10nF 100 V 5% X7R 0805 SMT	C0805C103J1RAC	Kemet
—	—	C37	10 n	CAP CRM 10 nF 100 V 5% X7R 0805 SMT	C0805C103J1RAC	Kemet
—	—	C38	10 n	CAP CRM 10 nF 100V 5% X7R 0805 SMT	C0805C103J1RAC	Kemet
9	2	C39	1 n	CAP CRM 1 nF/2000 V 10% X7R 1206 SMT	1206GC102KAT1A	AVX
—	—	C41	1 n	CAP CRM 1 nF/2000 V 10% X7R 1206 SMT	1206GC102KAT1A	AVX
10	3	C50	220 nF	CAP CRM 220NF 25V X7R 10% 0603	C1608X7R1E224K	TDK
—	—	C53	220 nF	CAP CRM 220NF 25 V X7R 10% 0603	C1608X7R1E224K	TDK
—	—	C67 ¹	220 nF	CAP CRM 220NF 25 V X7R 10% 0603	C1608X7R1E224K	TDK
11	2	C51	4.7 µ	CAP CRM X7R 4.7 µF 25 V 10% 1210	TMK325BJ475KN-T	Taiyo Yuden
—	—	C52	4.7 µ	CAP CRM X7R 4.7 µF 25 V 10% 1210	TMK325BJ475KN-T	Taiyo Yuden
12	8	C54	10 µF	CAP CRM X7R 10 µF 35 V 10% 1206	CL31B106KLHNNNE	Samsung
—	—	C55	10 µF	CAP CRM X7R 10 µF 35 V 10% 1206	CL31B106KLHNNNE	Samsung
—	—	C56	10 µF	CAP CRM X7R 10 µF 35 V 10% 1206	CL31B106KLHNNNE	Samsung
—	—	C57	10 µF	CAP CRM X7R 10 µF 35 V 10% 1206	CL31B106KLHNNNE	Samsung
—	—	C58	10 µF	CAP CRM X7R 10 µF 35 V 10% 1206	CL31B106KLHNNNE	Samsung

EV18R03A

Bill of Materials

.....continued						
Item	Qty	Ref	VALUE	DESCRIPTION	Mfr. Part Number	Mfr. Name
—	—	C102	10 µF	CAP CRM X7R 10 µF 35 V 10% 1206	CL31B106KLHNNNE	Samsung
—	—	C103	10 µF	CAP CRM X7R 10 µF 35V 10% 1206	CL31B106KLHNNNE	Samsung
—	—	C104	10 µF	CAP CRM X7R 10 µF 35V 10% 1206	CL31B106KLHNNNE	Samsung
13	1	C64 ¹	10 n	CAP CRM 10 nF 50 V 10% X7R 0603 SMT	B37931-K5103-K60	EPCOS
14	1	C65	1 n	CAP CRM 1 nF/2000 V 10% X7R 1206 SMT	1206B102K202CT	Walsin
15	1	C72	1 µF	CAP CRM X7R 1 µF 25 V 10% 0603 SMT	C0603C105K3RACTU	Kemet
16	1	C77	100 n	CAP CRM 100 nF 100V 10% X7R 1206 SMT	12061C104KAT2A	AVX
17	1	C92	47 n	CAP CRM 47 nF 100V 10% X7R 1206 SMT	12061C473KAT2A	AVX
18	1	C93	2.2 µF	CAP CRM 2.2 µF 100 V 10% X7R 1210 SMT	C3225X7R2A225K	TDK
19	2	C95 ¹	22 p	CAP CRM 22 pF 200 V 5% NPO 0805 SMT	0805N220J201NT	Novacap
—	—	C96	22 p	CAP CRM 22 pF 200 V 5% NPO 0805 SMT	0805N220J201NT	Novacap
20	1	C106	3.3 nF	CAP CRM,3.3 nF 16 V 10% X7R 0603	C1608X7R1C332K	TDK
21	2	C107	1 n	CAP CRM 1nF 100 V 5% X7R 0805 SMT	C2012X7R2A102K	TDK
		C108	1 n	CAP CRM 1 nF 100 V 5% X7R 0805 SMT	C2012X7R2A102K	TDK
22	2	C229	10 nf	CAP CRM 100 nF 100V 10% X7R 0603 SMT	C0603C103K1RACTU	Kemet
		C230	10 nf	CAP CRM 100nF 100V 10% X7R 0603 SMT	C0603C103K1RACTU	Kemet
23	6	C231	10 nf	CAP CRM 10 nF 100 V 10% X7R 0603 SMT	C0603C103K1RACTU	Kemet
—	—	C232	10 nf	CAP CRM 10 nF 100V 10% X7R 0603 SMT	C0603C103K1RACTU	Kemet
—	—	C233	10 nf	CAP CRM 10 nF 100V 10% X7R 0603 SMT	C0603C103K1RACTU	Kemet
—	—	C234	10 nf	CAP CRM 10 nF 100 V 10% X7R 0603 SMT	C0603C103K1RACTU	Kemet
—	—	C235	10 nf	CAP CRM 10 nF 100V 10% X7R 0603 SMT	C0603C103K1RACTU	Kemet
—	—	C236	10 nf	CAP CRM 10 nF 100 V 10% X7R 0603 SMT	C0603C103K1RACTU	Kemet
24	1	D2	EGL34D	Diode Switching 200 V 500 mA SOD123	EGL34D	Vishay
25	2	D4	SMAJ58CA	TVS DIODE 58VWM 93.6VC SMA	SMAJ58CA	Diodes Inc.
		D62	SMAJ58CA	TVS DIODE 58VWM 93.6VC SMA	SMAJ58CA	Diodes Inc.
26	2	D5	LED	LED SuperYelGrn 0603 SMD	19-21-SYGCS530E3	Everlight
—	—	D9	LED	LED SuperYelGrn 0603 SMD	19-21-SYGCS530E3	Everlight
27	1	D14	TL431	IC Prog Shunt Ref 2.5 V 2% SOT23-5 SMT	TL431CDBVRE4	TI
28	1	D24	STPS4S200B	DIODE SCHOTTKY 200 V 4 A DPAK	STPS4S200B-TR	STMicro
29	1	D55	MMSD701T	DIODE SCHOTTKY 70 V 0.2 A 225 W SOD123	MMSD701T1G	ON Semi
30	1	D58	BAV99W	Diode, Dual Switching BAV99W SOT323	BAV99W	NXP

EV18R03A

Bill of Materials

.....continued						
Item	Qty	Ref	VALUE	DESCRIPTION	Mfr. Part Number	Mfr. Name
31	1	D60	MBR0530	DIODE SCHOTTKY 30 V 500 MA SOD123	MBR0530-TP	Micro Commer
32	1	D61	SMAJ58A	DIO TVS 58 V 40 A SMA SMT	SMAJ58A	Vishay
33	1	D63	MMSZ5255B	Diode Zener, 28 V 500 mW 5% SOD123	MMSZ5255B	Diodes Inc.
36	1	J1	PD-CON2	Terminal block 2 Pole 3.5 mm	MB332-350M02	Deca
37	1	J4	VP6014 LF	1000 BASE-T SINGLE PORT VOIP MAG	VP6014 LF	BOTHHAND
38	1	L1	1 μ	INDUCTOR 1UH IRMS = 11A SMT	SRP7030-1R0M	Bourns
39	1	L4	4.7 μ H	FIXED IND 4.7 μ H 5.5 A 40 m Ω SMD	IHLP2525CZER4R7M01	Vishay
40	1	Q16	FDMS2672	MOSFET N-CH 200 V 3.7 A POWER56 SMT	FDMS2672	Fairchild
41	2	R1	0	Resistor, 0 Ω 5% 1/16 W 0402 SMT	CRCW04020000Z0ED	Vishay
—	—	R87	0	Resistor 0 Ω 5% 1/16 W 0402 SMT	CRCW04020000Z0ED	Vishay
42	1	R2	240K	Resistor, 240K 1% 1/10 W 0603	RK73H1JTDD2403F	KOA
43	1	R3	24.9K	RES 24.9 K 62.5 mW 1% 0603 SMT	RC1608F2492CS	Samsung
44	1	R9	0	Resistor, 0 Ω , 5% 1/16 W 0402	MCR01MZPJ000	Rohm
45	2	R31	562K	RES 562K 1% 1/16 W 0603 SMT	MCR03EZPFX5623	Rohm
—	—	R64	562K	RES 562K 1% 1/16 W 0603 SMT	MCR03EZPFX5623	Rohm
46	1	R34	51.1K	RES 51.1K 62.5 mW 1%0603 SMT	MCR03EZPFX5112	Rohm
47	1	R36	34K	RES 34K 62.5 mW 1%0603 SMT	D11 100 34K F P5	Vishay
48	4	R38	75	RES 75R 125 mW 1% 0805SMT	CR0805-FX-75R0-E	Bourns
—	—	R39	75	RES 75R 125mW 1% 0805SMT	CR0805-FX-75R0-E	Bourns
—	—	R40	75	RES 75R 125 mW 1% 0805SMT	CR0805-FX-75R0-E	Bourns
—	—	R41	75	RES 75R 125 mW 1% 0805SMT	CR0805-FX-75R0-E	Bourns
49	2	R44	0.15	RES TCK FLM 0.15R 0.1 W 1% 0603 SMT	CRL0603-JW-R150ELF	Bourns
—	—	R51	0.15	RES TCK FLM 0.15R 0.1 W 1% 0603 SMT	CRL0603-JW-R150ELF	Bourns
50	3	R47 ¹	20	RES 20 Ω 1/2 W 5% 1210 SMT	RK73B2ETTD200J	KOA
—	—	R130	20	RES 20 Ω 1/2 W 5% 1210 SMT	RK73B2ETTD200J	KOA
—	—	R192	20	RES 20 Ω 1/2 W 5% 1210 SMT	RK73B2ETTD200J	KOA
51	1	R52	56K	Resistor SMT 56K 1% 1/10 W 0603	RC0603FR-0756KL	Yageo
52	1	R53	332	RES 332R 62.5 mW 1% 0603 SMT	RC0603FRF07332R	Yageo
53	1	R54	6.49K	RES 6.49K 62.5 mW 1% 0603 SMT	RC1608F6491CS	Samsung
54	2	R63	30.9	Resistor 30.9R 1% 1/10 W 0603	ERJ3EKF30R9V	Panasonic
—	—	R86	30.9	Resistor 30.9R 1% 1/10 W 0603	ERJ3EKF30R9V	Panasonic
55	3	R71	7.5K	RES 7.5K 62.5 mW 1% 0603 SMT	RC1608F7501CS	Samsung

EV18R03A

Bill of Materials

.....continued						
Item	Qty	Ref	VALUE	DESCRIPTION	Mfr. Part Number	Mfr. Name
—	—	R72	7.5K	RES 7.5K 62.5 mW 1% 0603 SMT	RC1608F7501CS	Samsung
—	—	R77	7.5K	RES 7.5K 62.5 mW 1% 0603 SMT	RC1608F7501CS	Samsung
56	1	R73	10K	RES 10K 62.5 mW 1% 0603 SMT	MCR03EZPFX1002	Rohm
57	1	R76	3.65K	RES 3.65K 0.1 W 1% 0603 SMT	ERJ3EKF3651V	Panasonic
58	1	R81	18.7K	Resistor, 18.7K, 1% 1/16 W 0603	RC1608F1872CS	Samsung
59	1	R82	0	RES TCK FLM 0R 62.5 mW 5% 0603 SMT	MCR03EZPJ000	Rohm
60	1	R129	10K	RES 10K 62.5 mW 1% 0603 SMT	RC1608F1002CS	Samsung
61	1	R131	1M	RES 1M 62.5 mW 1% 0603 SMT	RC0603FRF071M	Yageo
62	1	T1	470 μ H	Common Mode Choke 470 μ H 1.6 A SMT	744272471	Würth
64	1	T6	32 μ H	Planar transformer 24 V/25 W 32 μ H	61213	Payton Group
65	1	U13	PD70201	AT POE PD controller IEEE 802.3	PD70201	Microchip
66	1	U16	PD70224	Ideal Diode Bridge dual 6 x 8 SMT	PD70224	Microchip
67	1	U18	MOC217	IC OPTOISOLATOR MOC217	MOC217 R2	Fairchild

Notes:

1. These parts are not installed (optional).
2. Parts might be replaced by equivalent alternatives.
3. Planar power transformer T6 might be replaced by Würth p/n 750314782, if low profile is not required.

9. Board Layout

EV18R03A is a two-layer board. The layers use two ounce copper. The following figures show the two copper layers and the silk board for tracking the device placements.

Figure 9-1. Top Silk

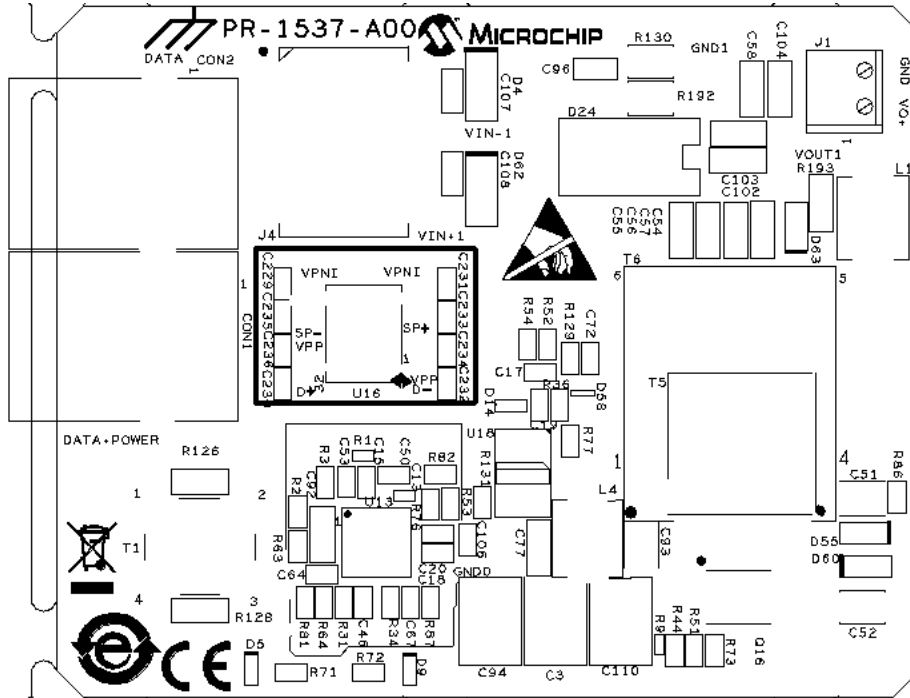

Figure 9-2. Top Layer

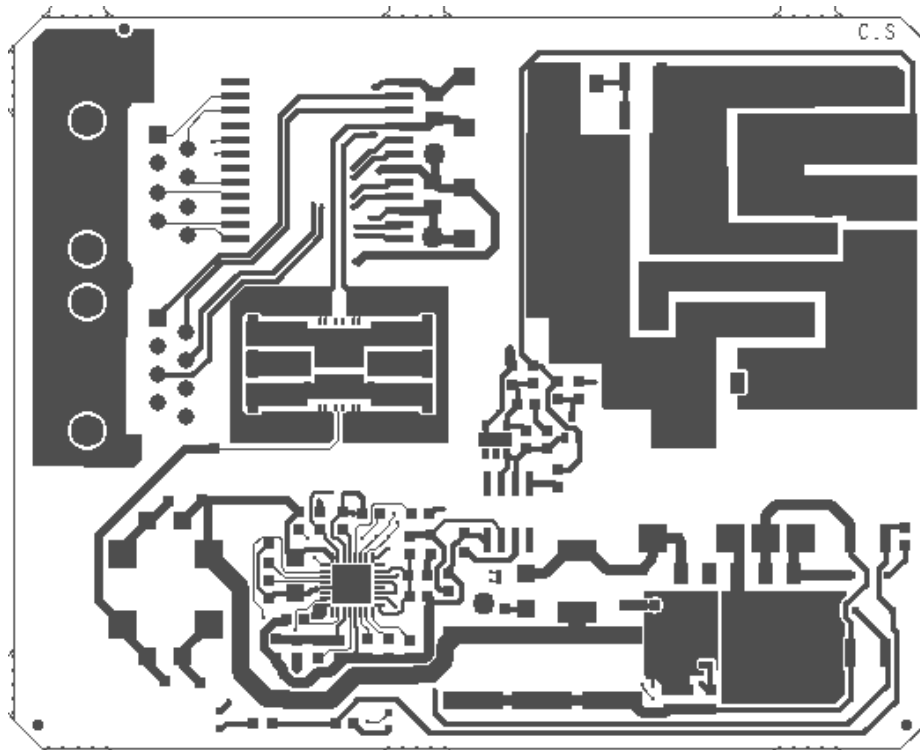

Figure 9-3. Bottom Layer

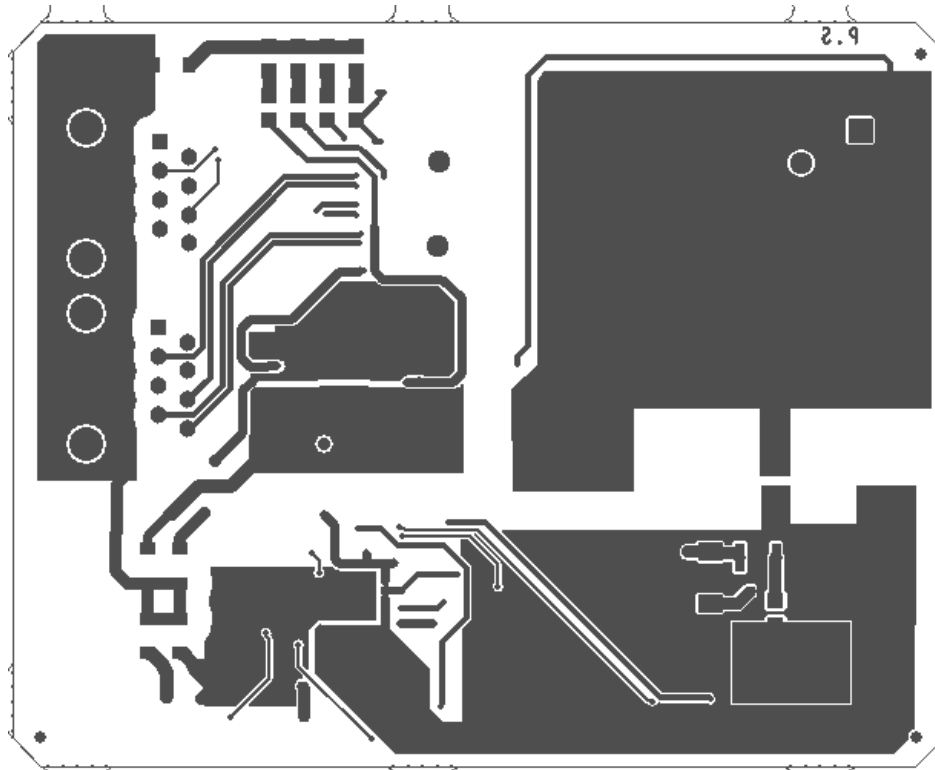
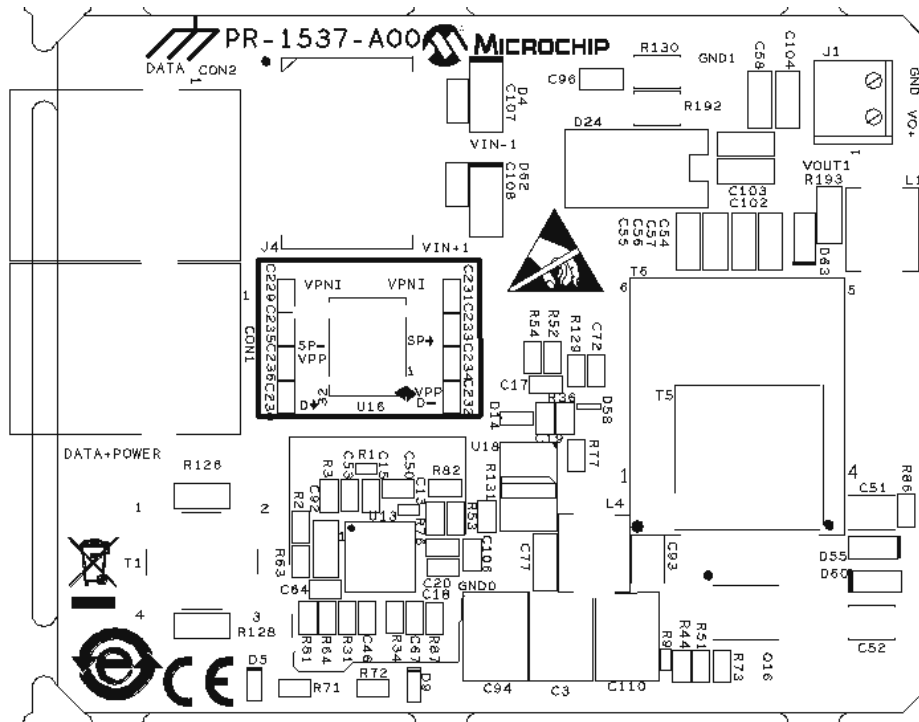

Figure 9-4. Bottom Silk



10. Reference Documents

- *PD70101/PD70201 Datasheet Power over Ethernet 802.3af/at PD Controller.*
- *AN3551 PD70101 and PD70201 PD Device Layout Guidelines.*
- *AN3471 Designing a Type 1/2 802.3 or HDBaseT Type 3 Powered Device Using PD702x1 and PD701x1 ICs.*
- *AN3472 Implementing Auxiliary Power in PoE.*

11. Revision History

Revision	Date	Description
A	08/2020	This is the initial release of the document.

The Microchip Website

Microchip provides online support via our website at www.microchip.com/. This website is used to make files and information easily available to customers. Some of the content available includes:

- **Product Support** – Data sheets and errata, application notes and sample programs, design resources, user's guides and hardware support documents, latest software releases and archived software
- **General Technical Support** – Frequently Asked Questions (FAQs), technical support requests, online discussion groups, Microchip design partner program member listing
- **Business of Microchip** – Product selector and ordering guides, latest Microchip press releases, listing of seminars and events, listings of Microchip sales offices, distributors and factory representatives

Product Change Notification Service

Microchip's product change notification service helps keep customers current on Microchip products. Subscribers will receive email notification whenever there are changes, updates, revisions or errata related to a specified product family or development tool of interest.

To register, go to www.microchip.com/pcn and follow the registration instructions.

Customer Support

Users of Microchip products can receive assistance through several channels:

- Distributor or Representative
- Local Sales Office
- Embedded Solutions Engineer (ESE)
- Technical Support

Customers should contact their distributor, representative or ESE for support. Local sales offices are also available to help customers. A listing of sales offices and locations is included in this document.

Technical support is available through the website at: www.microchip.com/support

Microchip Devices Code Protection Feature

Note the following details of the code protection feature on Microchip devices:

- Microchip products meet the specification contained in their particular Microchip Data Sheet.
- Microchip believes that its family of products is one of the most secure families of its kind on the market today, when used in the intended manner and under normal conditions.
- There are dishonest and possibly illegal methods used to breach the code protection feature. All of these methods, to our knowledge, require using the Microchip products in a manner outside the operating specifications contained in Microchip's Data Sheets. Most likely, the person doing so is engaged in theft of intellectual property.
- Microchip is willing to work with the customer who is concerned about the integrity of their code.
- Neither Microchip nor any other semiconductor manufacturer can guarantee the security of their code. Code protection does not mean that we are guaranteeing the product as "unbreakable."

Code protection is constantly evolving. We at Microchip are committed to continuously improving the code protection features of our products. Attempts to break Microchip's code protection feature may be a violation of the Digital Millennium Copyright Act. If such acts allow unauthorized access to your software or other copyrighted work, you may have a right to sue for relief under that Act.

Legal Notice

Information contained in this publication regarding device applications and the like is provided only for your convenience and may be superseded by updates. It is your responsibility to ensure that your application meets with

your specifications. MICROCHIP MAKES NO REPRESENTATIONS OR WARRANTIES OF ANY KIND WHETHER EXPRESS OR IMPLIED, WRITTEN OR ORAL, STATUTORY OR OTHERWISE, RELATED TO THE INFORMATION, INCLUDING BUT NOT LIMITED TO ITS CONDITION, QUALITY, PERFORMANCE, MERCHANTABILITY OR FITNESS FOR PURPOSE. Microchip disclaims all liability arising from this information and its use. Use of Microchip devices in life support and/or safety applications is entirely at the buyer's risk, and the buyer agrees to defend, indemnify and hold harmless Microchip from any and all damages, claims, suits, or expenses resulting from such use. No licenses are conveyed, implicitly or otherwise, under any Microchip intellectual property rights unless otherwise stated.

Trademarks

The Microchip name and logo, the Microchip logo, Adaptec, AnyRate, AVR, AVR logo, AVR Freaks, BesTime, BitCloud, chipKIT, chipKIT logo, CryptoMemory, CryptoRF, dsPIC, FlashFlex, flexPWR, HELDO, IGLOO, JukeBlox, KeeLoq, Kleer, LANCheck, LinkMD, maXStylus, maXTouch, MediaLB, megaAVR, Microsemi, Microsemi logo, MOST, MOST logo, MPLAB, OptoLyzer, PackeTime, PIC, picoPower, PICSTART, PIC32 logo, PolarFire, Prochip Designer, QTouch, SAM-BA, SenGenuity, SpyNIC, SST, SST Logo, SuperFlash, Symmetricom, SyncServer, Tachyon, TempTrackr, TimeSource, tinyAVR, UNI/O, Vectron, and XMEGA are registered trademarks of Microchip Technology Incorporated in the U.S.A. and other countries.

APT, ClockWorks, The Embedded Control Solutions Company, EtherSynch, FlashTec, Hyper Speed Control, HyperLight Load, IntelliMOS, Libero, motorBench, mTouch, Powermite 3, Precision Edge, ProASIC, ProASIC Plus, ProASIC Plus logo, Quiet-Wire, SmartFusion, SyncWorld, Temux, TimeCesium, TimeHub, TimePictra, TimeProvider, Vite, WinPath, and ZL are registered trademarks of Microchip Technology Incorporated in the U.S.A.

Adjacent Key Suppression, AKS, Analog-for-the-Digital Age, Any Capacitor, AnyIn, AnyOut, BlueSky, BodyCom, CodeGuard, CryptoAuthentication, CryptoAutomotive, CryptoCompanion, CryptoController, dsPICDEM, dsPICDEM.net, Dynamic Average Matching, DAM, ECAN, EtherGREEN, In-Circuit Serial Programming, ICSP, INICnet, Inter-Chip Connectivity, JitterBlocker, KleerNet, KleerNet logo, memBrain, Mindi, MiWi, MPASM, MPF, MPLAB Certified logo, MPLIB, MPLINK, MultiTRAK, NetDetach, Omniscient Code Generation, PICDEM, PICDEM.net, PICkit, PICtail, PowerSmart, PureSilicon, QMatrix, REAL ICE, Ripple Blocker, SAM-ICE, Serial Quad I/O, SMART-I.S., SQI, SuperSwitcher, SuperSwitcher II, Total Endurance, TSHARC, USBCheck, VariSense, ViewSpan, WiperLock, Wireless DNA, and ZENA are trademarks of Microchip Technology Incorporated in the U.S.A. and other countries.

SQTP is a service mark of Microchip Technology Incorporated in the U.S.A.

The Adaptec logo, Frequency on Demand, Silicon Storage Technology, and Symmcom are registered trademarks of Microchip Technology Inc. in other countries.

GestIC is a registered trademark of Microchip Technology Germany II GmbH & Co. KG, a subsidiary of Microchip Technology Inc., in other countries.

All other trademarks mentioned herein are property of their respective companies.

© 2020, Microchip Technology Incorporated, Printed in the U.S.A., All Rights Reserved.

ISBN: 978-1-5224-6573-7

Quality Management System

For information regarding Microchip's Quality Management Systems, please visit www.microchip.com/quality.

Worldwide Sales and Service

AMERICAS	ASIA/PACIFIC	ASIA/PACIFIC	EUROPE
<p>Corporate Office 2355 West Chandler Blvd. Chandler, AZ 85224-6199 Tel: 480-792-7200 Tel: 480-792-7277 Technical Support: www.microchip.com/support Web Address: www.microchip.com</p> <p>Atlanta Duluth, GA Tel: 678-957-9614 Fax: 678-957-1455</p> <p>Austin, TX Tel: 512-257-3370</p> <p>Boston Westborough, MA Tel: 774-760-0087 Fax: 774-760-0088</p> <p>Chicago Itasca, IL Tel: 630-285-0071 Fax: 630-285-0075</p> <p>Dallas Addison, TX Tel: 972-818-7423 Fax: 972-818-2924</p> <p>Detroit Novi, MI Tel: 248-848-4000</p> <p>Houston, TX Tel: 281-894-5983</p> <p>Indianapolis Noblesville, IN Tel: 317-773-8323 Fax: 317-773-5453 Tel: 317-536-2380</p> <p>Los Angeles Mission Viejo, CA Tel: 949-462-9523 Fax: 949-462-9608 Tel: 951-273-7800</p> <p>Raleigh, NC Tel: 919-844-7510</p> <p>New York, NY Tel: 631-435-6000</p> <p>San Jose, CA Tel: 408-735-9110 Tel: 408-436-4270</p> <p>Canada - Toronto Tel: 905-695-1980 Fax: 905-695-2078</p>	<p>Australia - Sydney Tel: 61-2-9868-6733</p> <p>China - Beijing Tel: 86-10-8569-7000</p> <p>China - Chengdu Tel: 86-28-8665-5511</p> <p>China - Chongqing Tel: 86-23-8980-9588</p> <p>China - Dongguan Tel: 86-769-8702-9880</p> <p>China - Guangzhou Tel: 86-20-8755-8029</p> <p>China - Hangzhou Tel: 86-571-8792-8115</p> <p>China - Hong Kong SAR Tel: 852-2943-5100</p> <p>China - Nanjing Tel: 86-25-8473-2460</p> <p>China - Qingdao Tel: 86-532-8502-7355</p> <p>China - Shanghai Tel: 86-21-3326-8000</p> <p>China - Shenyang Tel: 86-24-2334-2829</p> <p>China - Shenzhen Tel: 86-755-8864-2200</p> <p>China - Suzhou Tel: 86-186-6233-1526</p> <p>China - Wuhan Tel: 86-27-5980-5300</p> <p>China - Xian Tel: 86-29-8833-7252</p> <p>China - Xiamen Tel: 86-592-2388138</p> <p>China - Zhuhai Tel: 86-756-3210040</p>	<p>India - Bangalore Tel: 91-80-3090-4444</p> <p>India - New Delhi Tel: 91-11-4160-8631</p> <p>India - Pune Tel: 91-20-4121-0141</p> <p>Japan - Osaka Tel: 81-6-6152-7160</p> <p>Japan - Tokyo Tel: 81-3-6880-3770</p> <p>Korea - Daegu Tel: 82-53-744-4301</p> <p>Korea - Seoul Tel: 82-2-554-7200</p> <p>Malaysia - Kuala Lumpur Tel: 60-3-7651-7906</p> <p>Malaysia - Penang Tel: 60-4-227-8870</p> <p>Philippines - Manila Tel: 63-2-634-9065</p> <p>Singapore Tel: 65-6334-8870</p> <p>Taiwan - Hsin Chu Tel: 886-3-577-8366</p> <p>Taiwan - Kaohsiung Tel: 886-7-213-7830</p> <p>Taiwan - Taipei Tel: 886-2-2508-8600</p> <p>Thailand - Bangkok Tel: 66-2-694-1351</p> <p>Vietnam - Ho Chi Minh Tel: 84-28-5448-2100</p>	<p>Austria - Wels Tel: 43-7242-2244-39 Fax: 43-7242-2244-393</p> <p>Denmark - Copenhagen Tel: 45-4485-5910 Fax: 45-4485-2829</p> <p>Finland - Espoo Tel: 358-9-4520-820</p> <p>France - Paris Tel: 33-1-69-53-63-20 Fax: 33-1-69-30-90-79</p> <p>Germany - Garching Tel: 49-8931-9700</p> <p>Germany - Haan Tel: 49-2129-3766400</p> <p>Germany - Heilbronn Tel: 49-7131-72400</p> <p>Germany - Karlsruhe Tel: 49-721-625370</p> <p>Germany - Munich Tel: 49-89-627-144-0 Fax: 49-89-627-144-44</p> <p>Germany - Rosenheim Tel: 49-8031-354-560</p> <p>Israel - Ra'anana Tel: 972-9-744-7705</p> <p>Italy - Milan Tel: 39-0331-742611 Fax: 39-0331-466781</p> <p>Italy - Padova Tel: 39-049-7625286</p> <p>Netherlands - Drunen Tel: 31-416-690399 Fax: 31-416-690340</p> <p>Norway - Trondheim Tel: 47-72884388</p> <p>Poland - Warsaw Tel: 48-22-3325737</p> <p>Romania - Bucharest Tel: 40-21-407-87-50</p> <p>Spain - Madrid Tel: 34-91-708-08-90 Fax: 34-91-708-08-91</p> <p>Sweden - Gothenberg Tel: 46-31-704-60-40</p> <p>Sweden - Stockholm Tel: 46-8-5090-4654</p> <p>UK - Wokingham Tel: 44-118-921-5800 Fax: 44-118-921-5820</p>