

ASDL-4264

High Efficiency T-1 3/4 (5mm) Infrared (940nm) Lamp



Data Sheet

Description

ASDL-4264 is a Infrared emitter that is optimized for high efficiency at emission wavelength of 940nm. This device is designed for high current and low forward voltage applications. It is encapsulated in T1-3/4 (5mm) package and is suitable for high performance replacements of standard emitters.

Applications

- Smoke Detector
- IR Remote Control for Consumer Devices
- IR Remote Control for Industrial Equipment
- Photo-interrupters
- Reflective Applications
- Infrared Illuminator Security Camera

Features

- T 1- 3/4 Package
- 940nm Wavelength
- Narrow Viewing Angle
- Low Forward Voltage
- Ideal for High Current and Low Forward Voltage Application
- Paired Device to ASDL-5770 and ASDL-5771
- Design for Smoke Detector & Fire Alarm Application
- Lead Free & ROHS Compliant
- Available in Tape & Reel

Ordering Information

| Part Number | Lead Form | Color | Packaging | Shipping Option |
|---------------|-----------|-------|-------------|------------------|
| ASDL-4264-C22 | Straight | Clear | Tape & Reel | 2000pcs |
| ASDL-4264-C31 | | | Bulk | 8000pcs / Carton |

Absolute Maximum Ratings at 25°C

| Parameter | Symbol | Min. | Max | Unit | Reference |
|--|---------------------|------|-----|------|-----------|
| Peak Forward Current | I_{FPK} | | 3 | A | 300pps |
| DC Forward Current | I_{FDC} | | 150 | mA | |
| Power Dissipation | P_{DISS} | | 250 | mW | |
| Reverse Voltage | V_R | | 5 | V | |
| Operating Temperature | T_0 | -40 | 85 | °C | |
| Storage Temperature | T_S | -55 | 100 | °C | |
| LED Junction Temperature | T_J | | 110 | °C | |
| Lead Soldering Temperature [1.6mm (0.063") From Body] | 260°C for 5 seconds | | | | |

Electrical Characteristics at 25°C

| Parameter | Symbol | Min. | Typ. | Max. | Unit | Condition |
|---|----------------|------|------|------|------|----------------|
| Forward Voltage | V_F | | 1.2 | 1.6 | V | $I_{FDC}=20mA$ |
| Reverse Voltage | V_R | 5 | | | V | $I_R=100\mu A$ |
| Thermal Resistance Junction to Ambient | $R\theta_{ja}$ | | 250 | | °C/W | |

Optical Characteristics at 25°C

| Parameter | Symbol | Min. | Typ. | Max. | Unit | Condition | Bin |
|---------------------------|-----------------|------|------|-------|-------|--|-------|
| Radiant On-Axis Intensity | I_E | 6.02 | | 12.63 | mW/Sr | $I_{FDC}=20mA$ | Bin A |
| | | 8.42 | | | | | Bin B |
| Viewing Angle | $2\theta_{1/2}$ | | 22 | | deg | | |
| Peak wavelength | λ_{PK} | | 940 | | nm | $I_{FDC} = 20mA$ | |
| Spectral Width | $\Delta\lambda$ | | 50 | | nm | $I_{FDC} = 20mA$ | |
| Optical Rise Time | t_r | | 1 | | us | $I_{FPK}=100mA$ Duty Factor=50% Pulse Width=10us | |
| Optical Fall Time | t_f | | 1 | | us | $I_{FPK}=100mA$ Duty Factor=50% Pulse Width=10us | |

Package Dimension

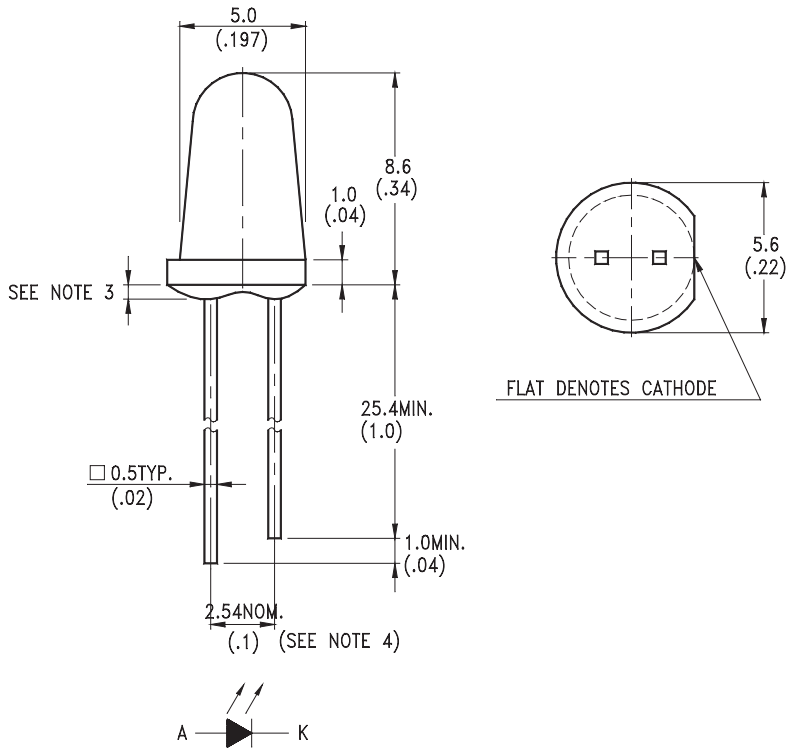

Notes:

1. All dimensions are in millimeters (inches)
2. Tolerance is + 0.25mm (.010") unless otherwise noted
3. Protuded resin under flange is 1.5mm (.059") max
4. Lead spacing is measured where leads emerge from package
5. Specifications are subject to change without notice

Typical Electrical / Optical Characteristics
 ($T_A = 25^\circ\text{C}$ Unless Otherwise Indicated)

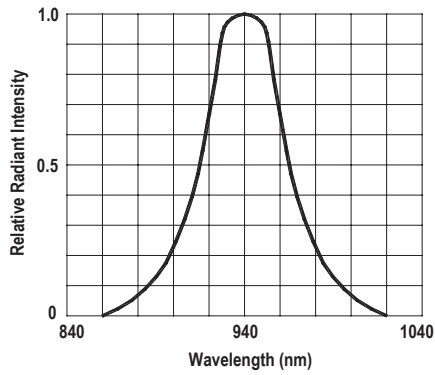

Figure 1. Spectral Distribution

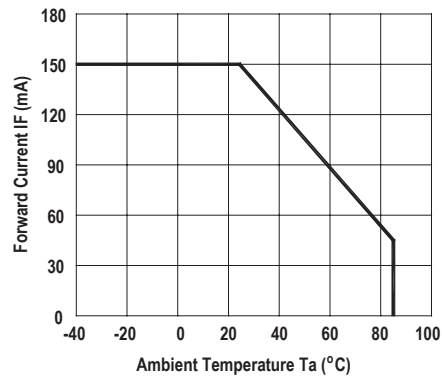

Figure 2. Forward Current Vs. Ambient Temperature

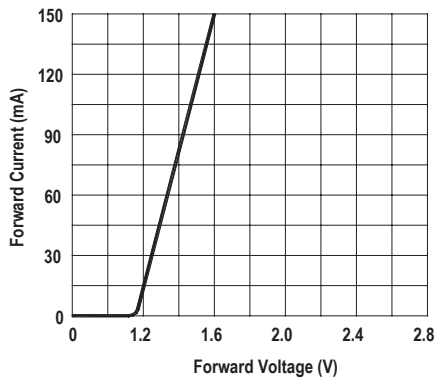

Figure 3. Forward Current Vs. Forward Voltage

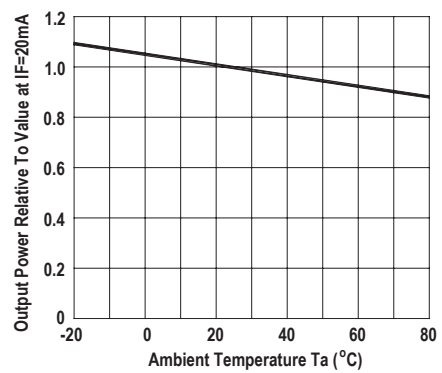

Figure 4. Relative Radiant Intensity Vs. Ambient Temperature

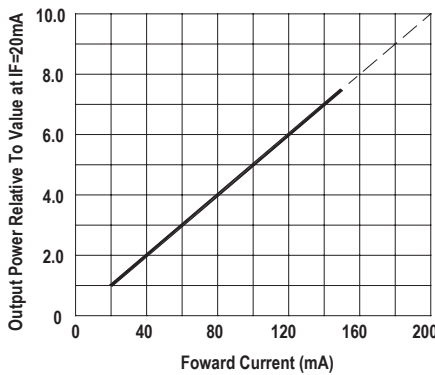

Figure 5. Relative Radiant Intensity Vs. Forward Current

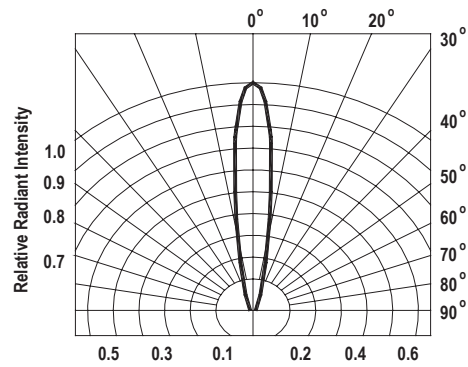

Figure 6. Radiation Diagram

For company and product information, please go to our web site: www.liteon.com or <http://optodatabook.liteon.com/databook/databook.aspx>

Data subject to change. Copyright © 2007 Lite-On Technology Corporation. All rights reserved.



Mouser Electronics

Authorized Distributor

Click to View Pricing, Inventory, Delivery & Lifecycle Information:

[Lite-On:](#)

[ASDL-4264-C22](#)