

- ▶ Timer multifunctional
- ▶ 8 Functions
- ▶ 7 time ranges
- ▶ Wide supply voltage range
- ▶ 2 change over contacts
- ▶ Width 22.5 mm
- ▶ Industrial design



Technical data

1. Functions

E	ON delay
R	OFF delay with control input
Es	ON delay with control input
Wu	Single shot leading edge voltage controlled
Ws	Single shot leading edge with control input
Wa	Single shot trailing edge with control input
Bi	Flasher pulse first
Bp	Flasher pause first

2. Time ranges

Time range	Adjustment range	
1s	50ms	1s
10s	500ms	10s
1min	3s	1min
10min	30s	10min
1h	3min	1h
10h	30min	10h
100h	5h	100h

3. Indicators

Green LED U/t ON:	indication of supply voltage
Green LED U/t flashes:	indication of time period
Yellow LED R ON/OFF:	indication of relay output

4. Mechanical design

Self-extinguishing plastic housing, IP rating IP40
 Mounted DIN-rail TS 35 according to EN 50022
 Mounting position: any
 Shockproof terminal connection according to VBG 4 (PZ1 required), IP rating IP20
 Tightening torque: max. 1Nm
 Terminal capacity:
 1 x 0.5 to 2.5mm² with/without multicore cable end
 1 x 4mm² without multicore cable end
 2 x 0.5 to 1.5mm² with/without multicore cable end
 2 x 2.5mm² flexible without multicore cable end

5. Input circuit

Supply voltage: terminals A1(+)-A2
 Types G2Z..12-240VAC/DC: 12 to 240V AC/DC
 Tolerance: 12V-10% to 240V+10%
 Rated consumption: 6VA (2W)
 Rated frequency: AC 48 to 63Hz
 Duty cycle: 100%
 Reset time: 100ms
 Residual ripple of DC: 10%
 Drop out voltage: >30% minimum rated supply voltage
 Overvoltage category: III (according to IEC 60664-1)
 Rated surge voltage: 4kV

6. Output circuit

2 potential free change over contacts
 Rated surge: 250V AC
 Switching capacity (distance <5mm):
 750VA (3A / 250V AC)
 Switching capacity (distance >5mm):
 1250V (5A / 250V AC)

Fusing: 5A fast acting
 Mechanical life: 20 x 10⁶ operations
 Electrical life: 2 x 10⁵ operations
 at 1000VA resistive load
 max. 60/min at 100VA resistive load
 max. 6/min at 1000VA resistive load
 (according to IEC 947-5-1)
 III. (according to IEC 60664-1)
 4kV
 Overvoltage category:
 Rated surge voltage: 4kV

7. Control input

Input not potential free: terminals A1-B1
 Loadable: yes
 Max. line length: 10m
 Trigger level (sensitivity): automatic adaption to supply voltage
 Min. control pulse length: DC 50 ms / AC 100 ms

8. Accuracy

Base accuracy: ±1% of maximum scale value
 Adjusting accuracy: <5% of maximum scale value
 Repetition accuracy: <0.5% or ±5ms
 Voltage influence: -
 Temperature influence: ≤0.01% / °C

9. Ambient conditions

Ambient temperature: -25 to +55°C (according to IEC 68-1)
 Storage temperature: -25 to +70°C
 Transport temperature: -25 to +70°C
 Relative humidity: 15% to 85%
 (according to IEC 721-3-3 Klasse 3K3)
 Pollution degree: 3 (according to IEC 664-1)
 Vibration resistance: 10 to 55 Hz 0.35mm
 (according to IEC 68-2-6)
 Shock resistance: 15g 11ms
 (according to IEC 68-2-27)

10. Dimensions

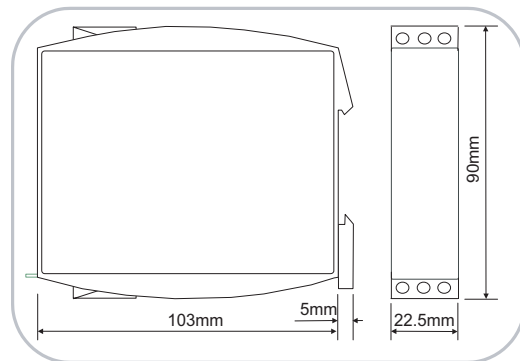

Functions

The function has to be set before connecting the relay to the supply voltage.

ON delay (E)

When the supply voltage U is applied, the set interval t begins (green LED U/t flashes). After the interval t has expired (green LED U/t illuminated) the output relay R switches into on-position (yellow LED illuminated). This status remains until the supply voltage is interrupted. If the supply voltage is interrupted before the expiry of the interval t, the interval already expired is erased and is restarted when the supply voltage is reapplied.

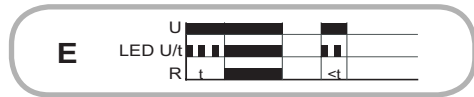

OFF delay (R)

The supply voltage U must be constantly applied to the device (green LED U/t illuminated). When the control contact S is closed, the output relay R switches into on-position (yellow LED illuminated). If the control contact is opened, the set interval t begins (green LED U/t flashes). After the interval t has expired (green LED U/t illuminated) the output relay switches into off-position (yellow LED not illuminated). If the control contact is closed again before the interval t has expired, the interval already expired is erased.

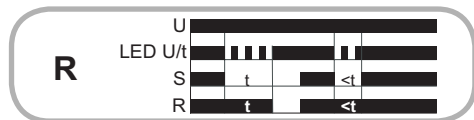

ON delay with control input (Es)

The supply voltage U must be constantly applied to the device (green LED U/t illuminated).

When the control contact S is closed, the set interval t begins (green LED U/t flashes). After the interval t has expired (green LED U/t illuminated) the output relay R switches into on-position (yellow LED illuminated). This status remains until the control contact is opened again.

If the control contact is opened before the interval t has expired, the interval already expired is erased and is restarted with the next cycle.

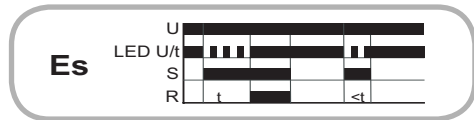

Connections

with control input

without control input

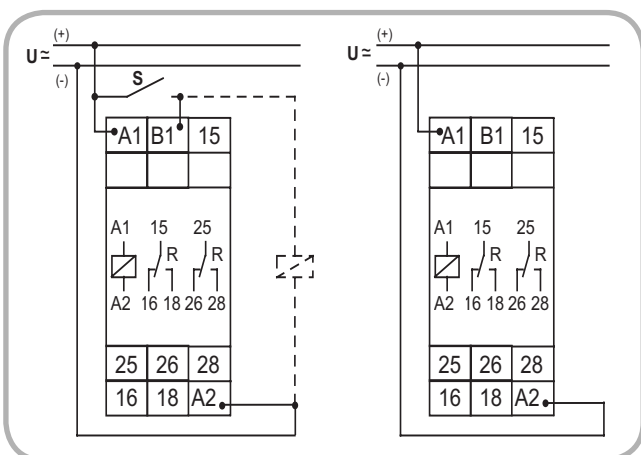

Single shot leading edge voltage controlled (Wu)

When the supply voltage U is applied, the output relay R switches into on-position (yellow LED illuminated) and the set interval t begins (green LED U/t flashes). After the interval t has expired (green LED U/t illuminated) the output relay switches into off-position (yellow LED not illuminated). This status remains until the supply voltage is interrupted. If the supply voltage is interrupted before the interval t has expired, the output relay switches immediately into off-position. The interval already is erased and is restarted when the supply voltage is reapplied.

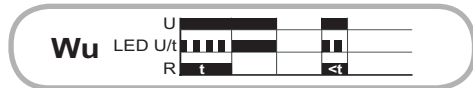

Single shot leading edge with control input (Ws)

The supply voltage U must be constantly applied to the device (green LED U/t illuminated). When the control contact S is closed, the output relay R switches into on-position (green LED U/t illuminated) and the set interval t begins (green LED U/t flashes). After the interval t has expired (green LED U/t illuminated) the output relay switches into off-position (yellow LED not illuminated). During the interval, the control contact can be operated any number of times. A further cycle can only be started when the cycle run has been completed.

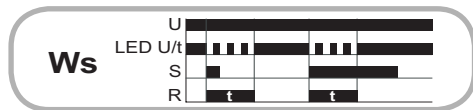

Single shot trailing edge with control input (Wa)

The supply voltage U must be constantly applied to the device (green LED U/t illuminated).

Closing the control contact S has no influence on the condition of the output R. When the control contact is opened, the output relay switches into on-position (yellow LED illuminated) and the set interval t begins (green LED U/t flashes). After the interval t has expired (green LED U/t illuminated), the output relay switches into off-position (yellow LED not illuminated). During the interval, the control contact can be operated any number of times. A further cycle can only be started when the cycle run has been completed.

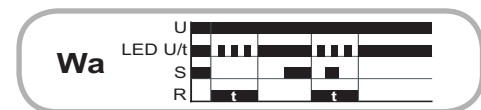

Flasher pulse first (Bi)

When the supply voltage U is applied, the output relay R switches into on-position (yellow LED illuminated) and the set interval t begins (green LED U/t flashes). After the interval t has expired, the output relay R switches into off-position (yellow LED not illuminated) and the set interval t begins again (green LED U/t flashes). The output relay is triggered at a ratio of 1:1 until the supply voltage is interrupted.

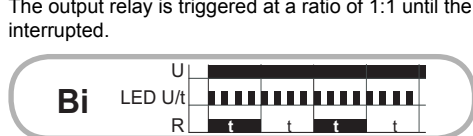

Flasher pause first (Bp)

When the supply voltage U is applied, the set interval t begins (green LED U/t flashes). After the interval t has expired, the output relay R switches into on-position (yellow LED illuminated) and the set interval t begins again. After the interval t has expired, the output relay switches into off-position (yellow LED not illuminated). The output relay is triggered at a ratio of 1:1 until the supply voltage is interrupted.

