

Large-size general purpose type well established
in various fields

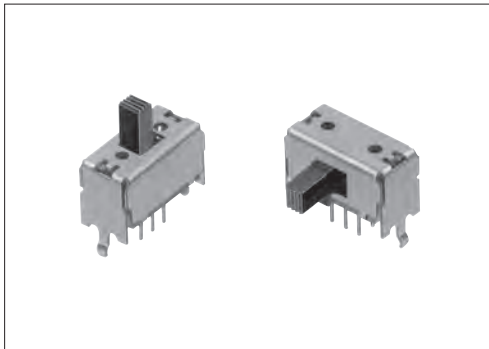

Typical Specifications



Items		Specifications
Rating (max.)/(min.) (Resistive load)		0.1A 30V DC / 50μA 3V DC
Contact resistance (Initial performance / After lifetime)		25mΩ max. / 65mΩ max.
Operating force		Refer to the dimensions.
Operating life	Without load	10,000 cycles
	With load	10,000 cycles (0.1A 30V DC)

Product Line

Travel (mm)	Actuator direction	Actuator length (mm)	Poles	Positions	Mounting method	Changeover timing	Soldering	Minimum order unit (pcs.)		Products No.	Drawing No.	
								Japan	Export			
2	Vertical	6	1	2	Snap-in (t1.6)	Non shorting	Manual, Dip	800	4,000	SSSF011700	1	
		9		3						SSSF012100		
		6		2						SSSF014800		2
		9	3	SSSF021500						3		
		6	2	SSSF021900								
		9	3	SSSF024800							4	
	Horizontal	1	6	4				2	600	3,000	SSSF111800	6
			9					2	800	4,000	SSSF112500	
			6					1	3	600	3,000	SSSF114900
			9	2					800	4,000	SSSF115300	
			6	2					2	600	3,000	SSSF121900
			9					3	800	4,000	SSSF122400	
		6	2					2	600	3,000	SSSF125300	9
		9		3				800	4,000	SSSF125800		
		6		4				2	800	4,000	SSSF141000	10
		9	3					800	4,000	SSSF141300		

Packing Specifications

Bulk

Products No.	Number of packages (pcs.)		Export package measurements (mm)
	1 case / Japan	1 case / export packing	
SSSF011700, SSSF012100 SSSF014800, SSSF021500 SSSF021900, SSSF024800 SSSF025100, SSSF040800 SSSF112500, SSSF115300 SSSF122400, SSSF125800 SSSF141000, SSSF141300	800	4,000	400×270×290
SSSF111800, SSSF114900 SSSF121900, SSSF125300	600	3,000	

■ Dimensions

Vertical Actuator Type

Unit:mm

No.	Style	PC board mounting hole dimensions (Viewed from direction A)
1	<p>1-pole, 2-position</p> <p>PC board mounting face Terminal No.①</p> <p>Operating force with detent : 2.5N l : shaft length</p>	<p>3-ϕ0.7 hole</p>
2	<p>1-pole, 3-position</p> <p>PC board mounting face Terminal No.①</p> <p>Operating force with detent : $a \rightarrow b$ } 2.2N $b \rightarrow a$ } 3N $c \rightarrow b$ } 2.2N $b \rightarrow c$ } 3N l : shaft length</p>	<p>5-ϕ0.7 hole</p>
3	<p>2-pole, 2-position</p> <p>PC board mounting face Terminal No.①</p> <p>Operating force with detent : 2.5N l : shaft length</p>	<p>6-ϕ0.7 hole</p>
4	<p>2-pole, 3-position</p> <p>PC board mounting face Terminal No.①</p> <p>Operating force with detent : $a \rightarrow b$ } 2.2N $b \rightarrow a$ } 3N $c \rightarrow b$ } 2.2N $b \rightarrow c$ } 3N l : shaft length</p>	<p>10-ϕ0.7 hole</p>
5	<p>4-pole, 2-position</p> <p>PC board mounting face Terminal No.①</p> <p>Operating force with detent : 2.5N l : shaft length</p>	<p>12-ϕ0.7 hole</p>

Detector
 Slide
 Push
 Rotary
 Power
 Dual-in-line Package Type
 Small size General Use Type
 Big size General Use Type

SSSF 8.5(H)mm, 2mm-travel Type

Dimensions

Horizontal Actuator Type

Unit:mm

No.	Style	PC board mounting hole dimensions (Viewed from direction A)
6	<p>1-pole, 2-position</p> <p>Operating force with detent : 2.5N l : shaft length</p>	<p>3-ϕ0.7 hole</p>
7	<p>1-pole, 3-position</p> <p>Operating force with detent : a \rightarrow b } 2N b \rightarrow a } 3N c \rightarrow b } b \rightarrow c } l : shaft length</p>	<p>5-ϕ0.7 hole</p>
8	<p>2-pole, 2-position</p> <p>Operating force with detent : 2.5N l : shaft length</p>	<p>6-ϕ0.7 hole</p>
9	<p>2-pole, 3-position</p> <p>Operating force with detent : a \rightarrow b } 2.2N b \rightarrow a } 3N c \rightarrow b } b \rightarrow c }</p> <p>l : shaft length</p>	<p>10-ϕ0.7 hole</p>
10	<p>4-pole, 2-position</p> <p>Operating force with detent : 2.5N l : shaft length</p>	<p>12-ϕ0.7 hole</p>

Circuit Diagram (Viewed from Direction A)

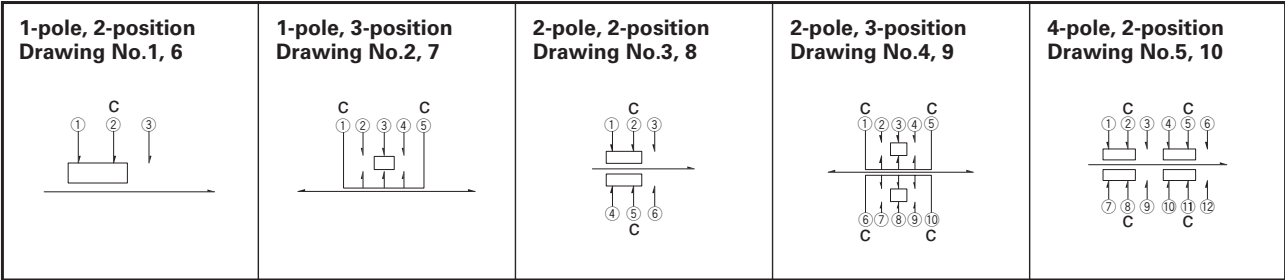

Actuator Configuration

Unit:mm

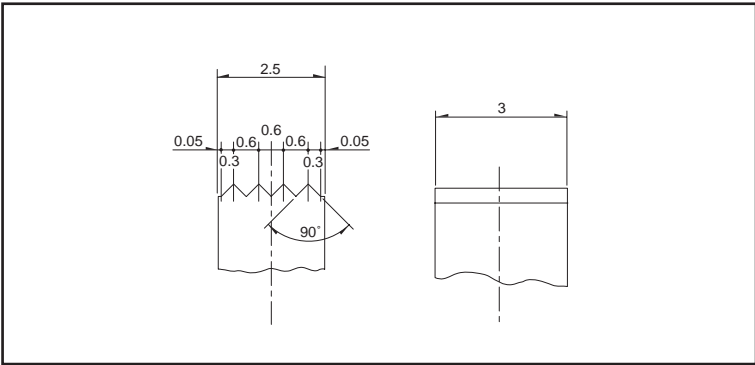

Shape of Frame Leg

Unit:mm

Pole - position	A	
	Vertical	Horizontal
1 - 2	15.5	15.5
1 - 3		
2 - 2		
2 - 3		
4 - 2	17.5	17.5

Thickness of PC board t=1.6

Detector

Slide

Push











Rotary

Power

Dual-in-line Packages Type

Small size General Use Type

Big size General Use Type

Series		SSSS2※	SSSS9	SSAC	SSSF	SSSU
Photo						
Actuator direction	Horizontal	●	●	●	●	●
	Vertical	●	●	—	●	●
Poles-positions	1-2	●	●	—	●	●
	1-3	●	●	—	●	●
	1-4	●	—	—	—	—
	2-2	●	●	●	●	●
	2-3	●	●	●	●	●
	2-4	●	—	—	—	—
	4-2	—	—	—	●	●
Travel (mm)		2	2	1.5	2	3
Operating temperature range		-40°C to +85°C		-10°C to +60°C	-40°C to +85°C	
Automotive use		—	—	—	—	—
Life cycle						
Rating (max.) (Resistive load)		0.3A 6V DC	0.1A 12V DC	1mA 5V DC	0.1A 30V DC	
Rating (min.) (Resistive load)		50μA 3V DC	1mA 5V DC	50μA 3V DC		
Durability	Operating life without load	10,000 cycles 100mΩ max.※	10,000 cycles 60mΩ max.	10,000 cycles 200mΩ max.	10,000 cycles 45mΩ max.	
	Operating life with load Load: as rating	10,000 cycles 130mΩ max.※	10,000 cycles 80mΩ max.		10,000 cycles 65mΩ max.	
Electrical performance	Initial contact resistance	70mΩ max.	30mΩ max.	100mΩ max.	25mΩ max.	
	Insulation resistance	100MΩ min. 500V DC		100MΩ min. 100V DC	100MΩ min. 500V DC	
	Voltage proof	500V AC for 1minute		100V AC for 1minute	500V AC for 1minute	
Mechanical performance	Terminal strength		3N for 1minute		5N for 1minute	
	Actuator strength	Operating direction	20N	30N	5N	30N
		Pulling direction	10N			
Environmental performance	Cold	-20°C 500h	-40°C 500h	-20°C 96h	-40°C 500h	
	Dry heat	85°C 500h		85°C 96h	85°C 500h	
	Damp heat	60°C, 90 to 95%RH 500h		40°C, 90 to 95%RH 96h	60°C, 90 to 95%RH 500h	
Page		85	90	96	98	102

Slide Switches Soldering Conditions	106
Slide Switches Cautions	107

Notes

- ※ Operating life for SSSS213202 is 100 cycles.
- Indicates applicability to all products in the series.

Example of Reflow Soldering Condition

1. Heating method: Double heating method with infrared heater.
2. Temperature measurement: Thermocouple ϕ 0.1 to 0.2 CA (K) or CC (T) at soldering portion (copper foil surface).
A heat resisting tape should be used for fixed measurement.
3. Temperature profile

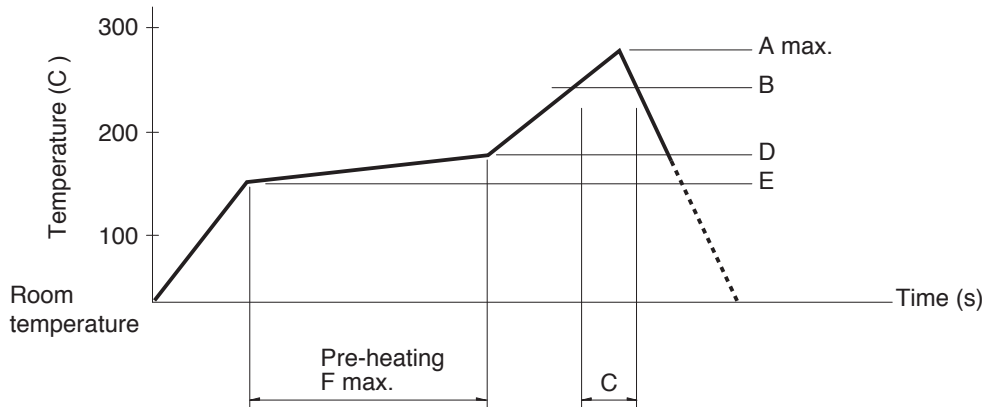

Series (Reflow type)		A (°C) 3s max.	B (°C)	C (s)	D (°C)	E (°C)	F (s)
SSSS2	Vertical 1-pole, 3-position	260	230	40	180	150	120
	Horizontal 1-pole, 2-position 1-pole, 3-position 2-pole, 3-position						
	Vertical 1-pole, 2-position	250					
SSAG, SSAJ, SSAL, SSSS8, SSS7		260					

Notes

1. The condition mentioned above is the temperature on the mounting surface of a PC board. There are cases where the PC board's temperature greatly differs from that of the switch, depending on the PC board's material, size, thickness, etc. The above-stated conditions shall also apply to switch surface temperatures.
2. Soldering conditions differ depending on reflow soldering machines. Prior verification of soldering condition is highly recommended.

Reference for Hand Soldering

Series	Soldering temperature	Soldering time
SSSF, SSSU	350±10°C	3+1/0s
SSSS2	350±10°C	4s max.
SSSS9	350±10°C	3s max.
SSAG, SSAJ, SSAL	350±5°C	3s max.
SSSS8	330±5°C	3s max.
SSSS7	320±5°C	3s max.
SSAC	300±10°C	2s max.

Reference for Dip Soldering

(For PC board terminal types)

Series	Items		Dip soldering	
	Preheating temperature	Preheating time	Soldering temperature	Duration of immersion
SSSS2	100°C max.	60s max.	260±5°C	3±1s
SSSS9	120°C max.	60s max.	260±5°C	5+0/-1s (2 times)
SSSF, SSSU	100°C max.	60s max.	260±5°C	10±1s/5±1s
SSAC	100°C max.	60s max.	260±5°C	5±1s