

Description

The AP7348 is a 4 channel low dropout regulator with high output voltage accuracy, low $R_{DS(ON)}$, high PSRR, low output noise and low quiescent current. This regulator is based on a CMOS process.

The AP7348 includes two voltage references, and four channels with each having an error amplifier, foldback current limiting, a discharge circuit and an independent resistor network to determine the fixed output voltage. The over temperature sensing is for each channel with all 4 channel being disabled during a temperature fault condition. The device has two enable inputs with EN1 controlling both V_{OUT1} and V_{OUT3} leaving V_{OUT2} and V_{OUT4} to be controlled by EN2. During disable the two associated channels will discharge.

With its low power consumption and line and load transient response, the AP7348 is well suited for low power handheld communication equipment.

The AP7348 is provided in the X1-DFN1612-8 (Type B) package allowing for a small footprint and a dense PCB layout.

Features

- Low V_{DD} and Wide V_{DD} Range: 1.7V to 5.25V
- Each Channel Output Current: 300mA
- V_{OUT} Accuracy $\pm 1\%$
- Ripple Rejection 75dB at 1kHz
- Low Output Noise, 60 μ Vrms from 10Hz to 100kHz
- Total 4 Channel Quiescent Current is Typically 160 μ A
- V_{OUT} Fixed 1.2V to 3.6V
- **Totally Lead-Free & Fully RoHS Compliant (Notes 1 & 2)**
- **Halogen and Antimony Free. "Green" Device (Note 3)**
- **For automotive applications requiring specific change control (i.e. parts qualified to AEC-Q100/101/200, PPAP capable, and manufactured in IATF 16949 certified facilities), please [contact us](mailto:contact@diodes.com) or your local Diodes representative. <https://www.diodes.com/quality/product-definitions/>**

- Notes:
1. No purposely added lead. Fully EU Directive 2002/95/EC (RoHS), 2011/65/EU (RoHS 2) & 2015/863/EU (RoHS 3) compliant.
 2. See <https://www.diodes.com/quality/lead-free/> for more information about Diodes Incorporated's definitions of Halogen- and Antimony-free, "Green" and Lead-free.
 3. Halogen- and Antimony-free "Green" products are defined as those which contain <900ppm bromine, <900ppm chlorine (<1500ppm total Br + Cl) and <1000ppm antimony compounds.

Pin Assignments

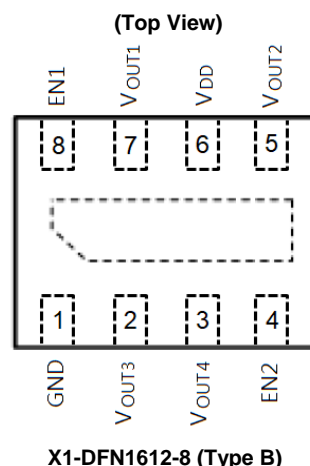

Applications

- Smart Phone/Tablet
- WIFI Access Points
- Communication Module
- Camera Module, Appliances
- RF Supply for IOT/LPWAN

Typical Applications Circuit

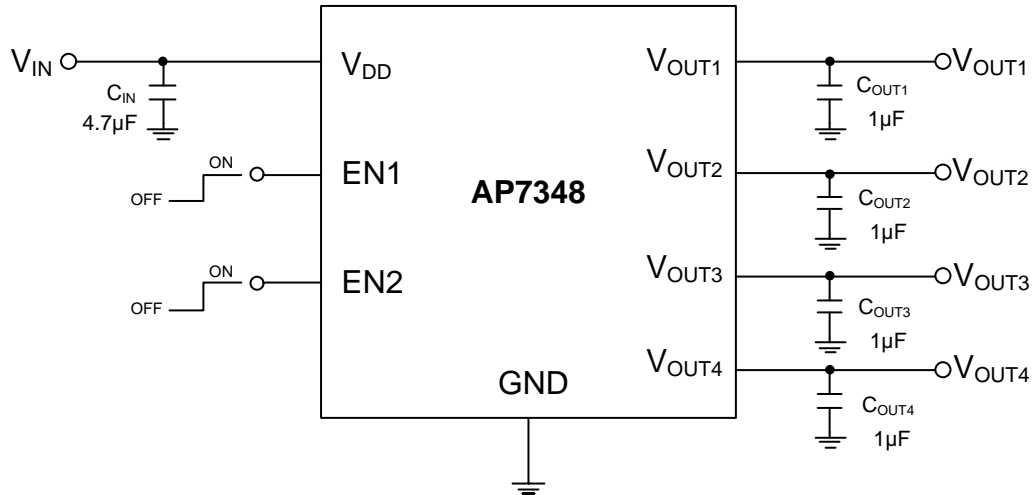

Pin Descriptions

Pin Number	Pin Name	Function
1	GND	Ground
2	VOUT3	Channel 3 Output Voltage Pin
3	VOUT4	Channel 4 Output Voltage Pin
4	EN2	Enable Pin to control CH2&CH4 This pin should be driven either high or low. Driving this pin high enables the regulator, while pulling it low puts the regulator into shutdown mode
5	VOUT2	Channel 2 Output Voltage Pin
6	VDD	Power Input Pin
7	VOUT1	Channel 1 Output Voltage Pin
8	EN1	Enable Pin to control CH1&CH3 This pin should be driven either high or low. Driving this pin high enables the regulator, while pulling it low puts the regulator into shutdown mode
—	Thermal Pad	This pad must be connected for thermal dissipation. Electrically it may be left open or connected to Ground. This does not replace the connection that is required for pin 1.

Functional Block Diagram

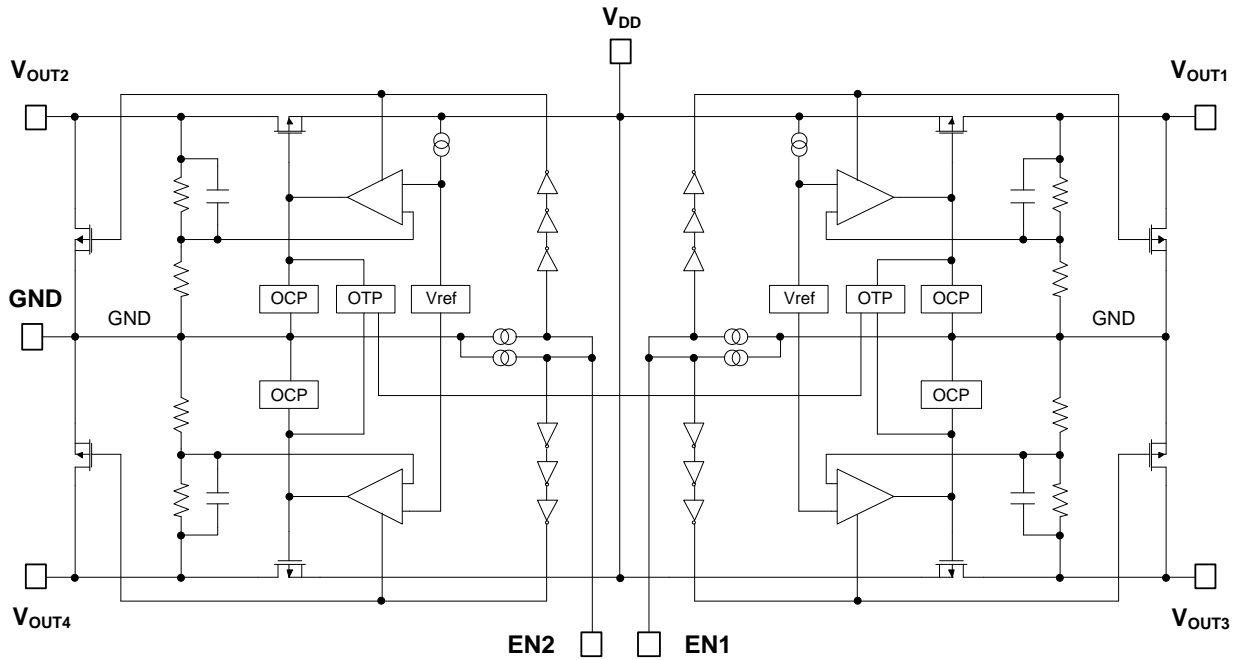

AP7348 (With Discharge)

Absolute Maximum Ratings (Note 4) (@ $T_A = +25^\circ\text{C}$, unless otherwise specified.)

Symbol	Parameter	Ratings	Unit
ESD HBM	Human Body Mode ESD Protection	± 2	kV
ESD CDM	Charge Device Model	± 500	V
V_{DD}	Input Voltage	6.0	V
V_{EN}	Input Voltage for EN Pins	6.0	V
V_{OUT}	Output Voltage	-0.3 to $V_{DD} + 0.3$	V
I_{OUT}	Each Channel Output Current	300	mA
P_D (Note 5)	Power Dissipation	600	mW
T_A	Operating Ambient Temperature	-40 to $+85$	$^\circ\text{C}$
T_{STG}	Storage Temperature	-55 to $+125$	$^\circ\text{C}$

- Notes:
4. a). Stresses beyond those listed under *Absolute Maximum Ratings* can cause permanent damage to the device. These are stress ratings only and functional operation of the device at these conditions is not implied. Exposure to absolute-maximum-rated conditions for extended period can affect device reliability.
 - b). Ratings apply to ambient temperature at $+25^\circ\text{C}$. The JEDEC High-K board design used to derive this data was a 2 inch \times 2 inch multilayer board with 1oz. internal power and ground planes and 2oz. copper traces on the top and bottom of the board.
 5. Even though AP7348 would provide each channel 300mA, user still need consider power dissipation can't over 600mW, or it will enable OTP function and get abnormal output voltage.

Recommended Operating Conditions (@ $T_A = +25^\circ\text{C}$, unless otherwise specified.)

Symbol	Parameter	Min	Max	Unit
V_{DD}	Input Voltage	1.7	5.25	V
I_{OUT}	Each Channel Output Current	0	300	mA
T_A	Operating Ambient Temperature	-40	$+85$	$^\circ\text{C}$

Electrical Characteristics (@ $T_A = +25^\circ\text{C}$, $V_{DD} = V_{EN} = V_{OUT_MAX\ Channel} + 1.0\text{V}$, $C_{IN} = 4.7\mu\text{F}$, $C_{OUT} = 1.0\mu\text{F}$, $I_{OUT} = 1.0\text{mA}$, unless otherwise specified.)

Parameter	Condition		Min	Typ	Max	Unit
Input Voltage	$T_A = -40^\circ\text{C}$ to $+85^\circ\text{C}$		1.7	—	5.25	V
Output Voltage Accuracy (Note 6)	$V_{OUT}(T) \geq 2.0\text{V}$, $V_{DD} = V_{OUT}(T)+1\text{V}$	$T_A = +25^\circ\text{C}$	$V_{OUT}(T)^*_{0.99}$	$V_{OUT}(T)$	$V_{OUT}(T)^*_{1.01}$	V
	$V_{OUT}(T) < 2.0\text{V}$, $V_{DD} = V_{OUT}(T)+1\text{V}$	$T_A = +25^\circ\text{C}$	$V_{OUT}(T)^*_{-20\text{mV}}$	$V_{OUT}(T)$	$V_{OUT}(T)^*_{+20\text{mV}}$	
Line Regulation ($dV_{OUT}/dV_{DD}/V_{OUT}$)	$V_{DD} = (V_{OUT_Nom} + 1.0\text{V})$ to 5.25V , $I_{OUT} = 1.0\text{mA}$		—	0.02	0.1	%/V
Load Regulation	$V_{DD} = V_{OUT_Nom} + 1.0\text{V}$, $I_{OUT} = 1\text{mA}$ to 300mA		—	15	30	mV
Quiescent Current (Note 7)	$I_{OUT} = 0\text{mA}$, $EN1 = \text{high}$, $EN2 = \text{low}$		—	80	140	μA
	$I_{OUT} = 0\text{mA}$, $EN1 = EN2 = \text{high}$		—	160	280	
Standby Current ($I_{STANDBY}$)	$V_{EN} = 0\text{V}$ (Disabled)		—	0.01	1.0	μA
Each Channel Output Current (Note 5)	—		300	—	—	mA
Fold-Back Short Current (Note 8)	V_{OUT} Short to Ground		—	55	—	mA
PSRR (Note 9)	$V_{DD} = (V_{OUT} + 1\text{V}) V_{DC} + 0.2\text{Vp-pAC}$, $V_{OUT} \geq 1.8\text{V}$, $I_{OUT} = 30\text{mA}$, $EN1$ turns on and $EN2$ turns off, or $EN1$ turns off and $EN2$ turns on	$f = 1\text{kHz}$	—	75	—	dB
Output Noise Voltage (Note 9) (Note 10)	$BW = 10\text{Hz}$ to 100kHz , $I_{OUT} = 30\text{mA}$		—	60	—	μVrms
Dropout Voltage (Note 11)	$I_{OUT} = 300\text{mA}$	$1.1\text{V} \leq V_{OUT} < 1.5\text{V}$	—	0.51	0.80	V
		$1.5\text{V} \leq V_{OUT} < 1.7\text{V}$	—	0.38	0.53	
		$1.7\text{V} \leq V_{OUT} < 2.0\text{V}$	—	0.34	0.48	
		$2.0\text{V} \leq V_{OUT} < 2.5\text{V}$	—	0.28	0.42	
		$2.5\text{V} \leq V_{OUT} < 2.8\text{V}$	—	0.27	0.36	
		$2.8\text{V} \leq V_{OUT} < 3.0\text{V}$	—	0.26	0.34	
		$3.0\text{V} \leq V_{OUT} < 3.6\text{V}$	—	0.25	0.33	
Output Voltage Temperature Coefficient	$I_{OUT} = 30\text{mA}$, $T_A = -40^\circ\text{C}$ to $+85^\circ\text{C}$		—	± 30	—	ppm/ $^\circ\text{C}$
Thermal Shutdown Threshold (TSHDN)	—		—	+155	—	$^\circ\text{C}$
Thermal Shutdown Hysteresis (THYS)	—		—	+25	—	$^\circ\text{C}$
EN Input Low Voltage	—		0	—	0.5	V
EN Input High Voltage	—		1.3	—	5.25	V
EN Input Leakage	$V_{EN} = 0$, $V_{DD} = 5.0\text{V}$ or $V_{EN} = 5.0\text{V}$, $V_{DD} = 0\text{V}$		-1.0	—	+1.0	μA
On Resistance of N-Channel for Auto-Discharge	$V_{DD} = 4.0\text{V}$, $V_{OUT} = 0.2\text{V}$, $V_{EN} = 0\text{V}$ (Disabled)		—	10	—	Ω
Thermal Resistance Junction to Ambient (θ_{JA})	X1-DFN1612-8 (Type B)		—	160	—	$^\circ\text{C/W}$
Thermal Resistance Junction to Case (θ_{JC})	X1-DFN1612-8 (Type B)		—	26	—	

- Notes:
5. Even though AP7348 would provide each channel 300mA, user still need consider power dissipation can't over 600mW, or it will enable OTP function and get abnormal output voltage.
 6. Potential multiple grades based on following output voltage accuracy.
 7. Quiescent current is defined here is the difference in current between the input and the output.
 8. Short circuit current is measured with V_{OUT} pulled to GND.
 9. This specification is guaranteed by design.
 10. To make sure lowest environment noise minimizes the influence on noise measurement.
 11. Dropout voltage is the voltage difference between the input and the output at which the output voltage drops 2% below its nominal value.

Typical Performance Characteristics (@ $T_A = +25^\circ\text{C}$, $C_{IN} = 4.7\mu\text{F}$, $C_{OUT1} = C_{OUT2} = C_{OUT3} = C_{OUT4} = 1\mu\text{F}$)

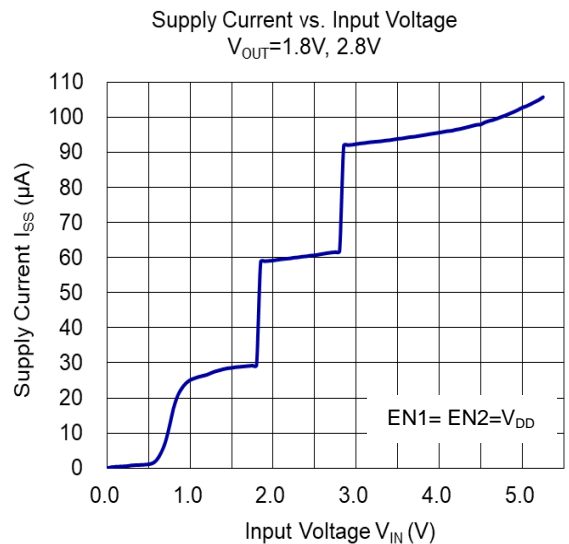
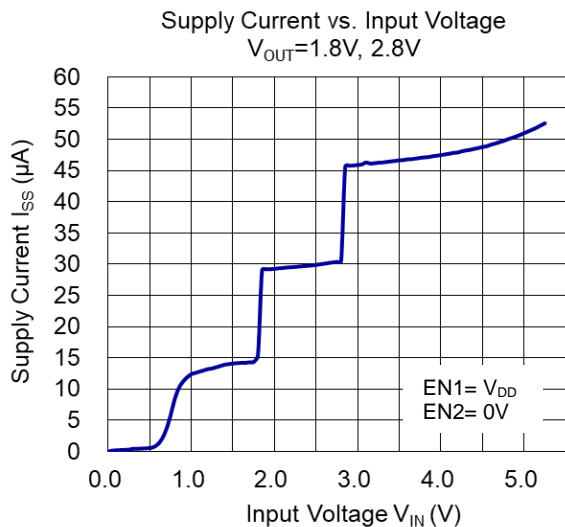
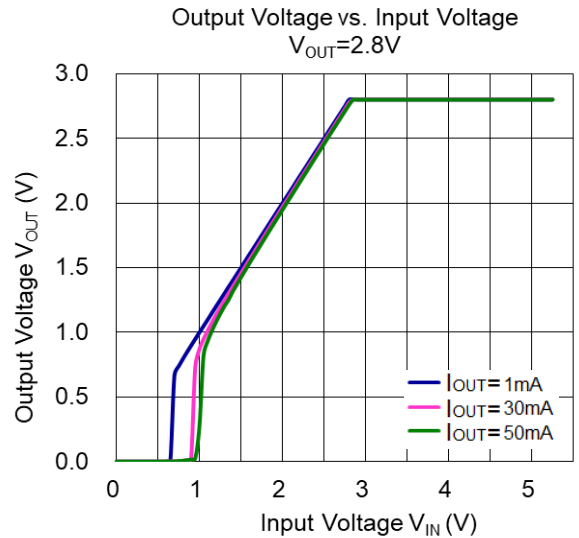
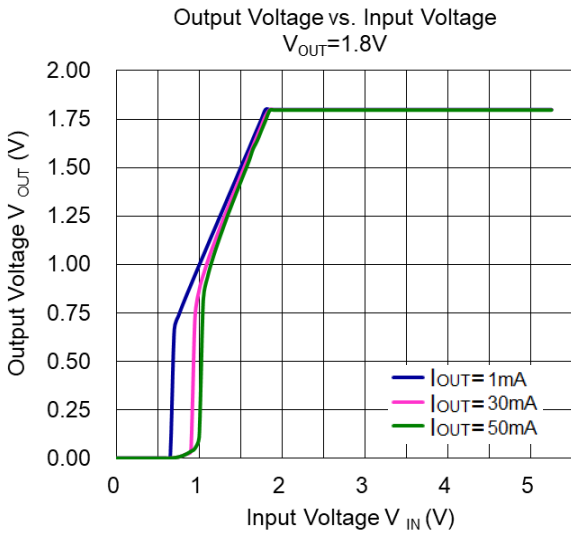
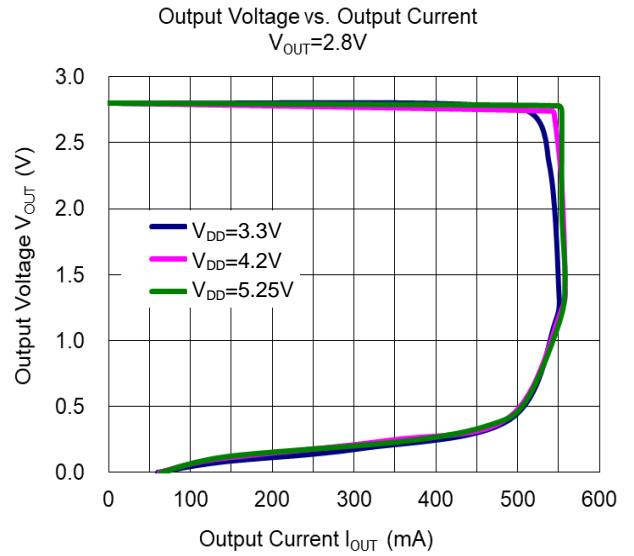
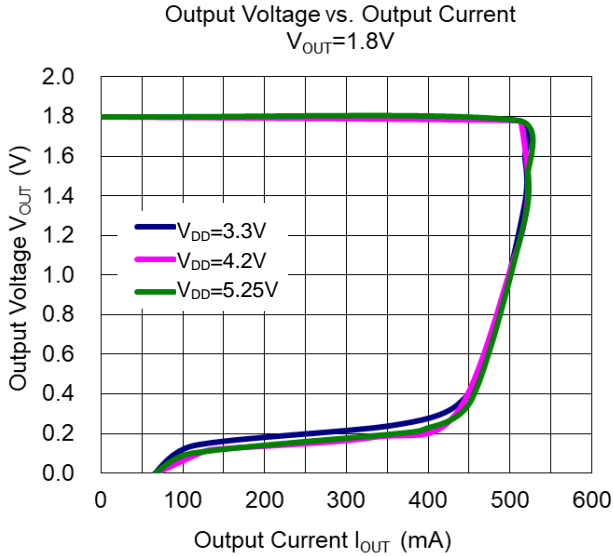

Typical Performance Characteristics (continued) (@T_A = +25°C, C_{IN} = 4.7μF, C_{OUT1} = C_{OUT2} = C_{OUT3} = C_{OUT4} = 1μF)

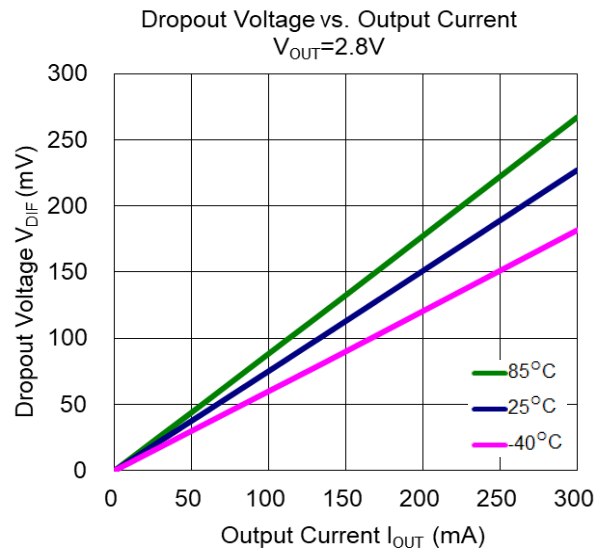
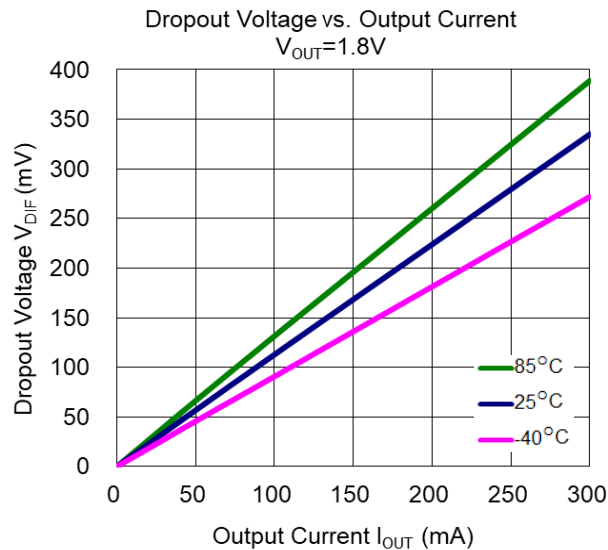
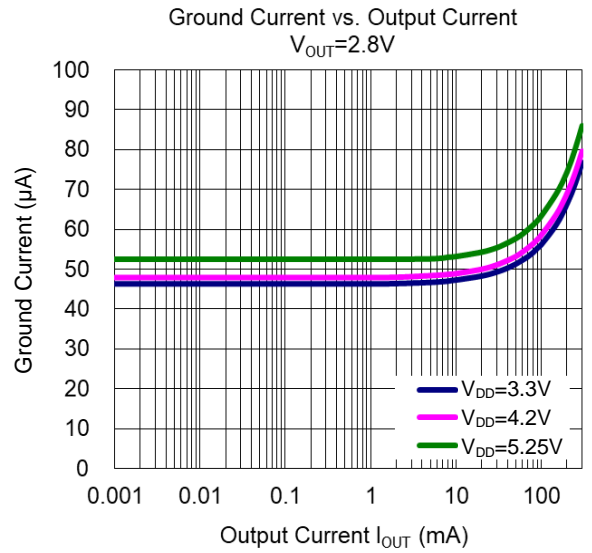
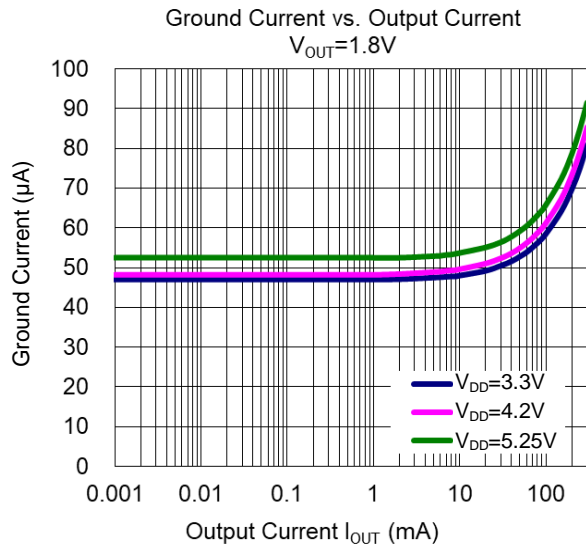
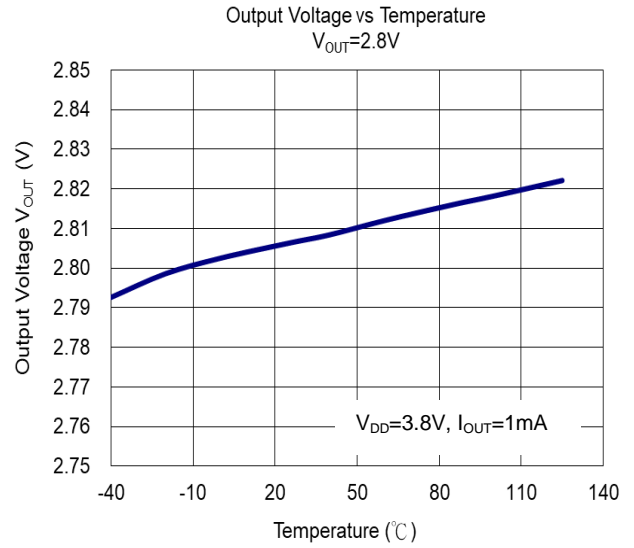
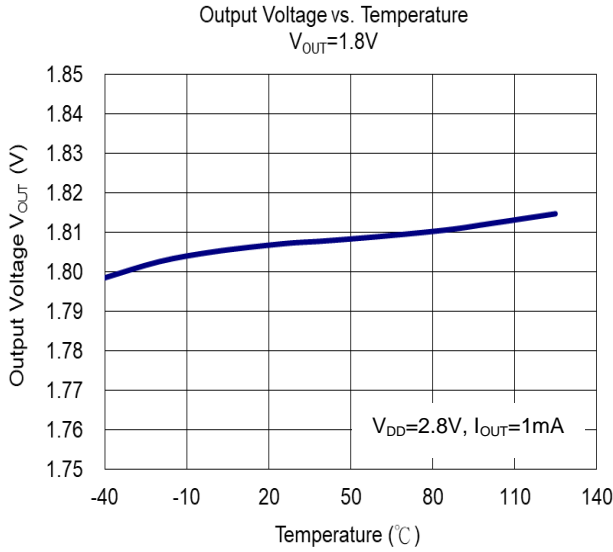

Typical Performance Characteristics (continued) (@T_A = +25°C, C_{IN} = 4.7μF, C_{OUT1} = C_{OUT2} = C_{OUT3} = C_{OUT4} = 1μF)

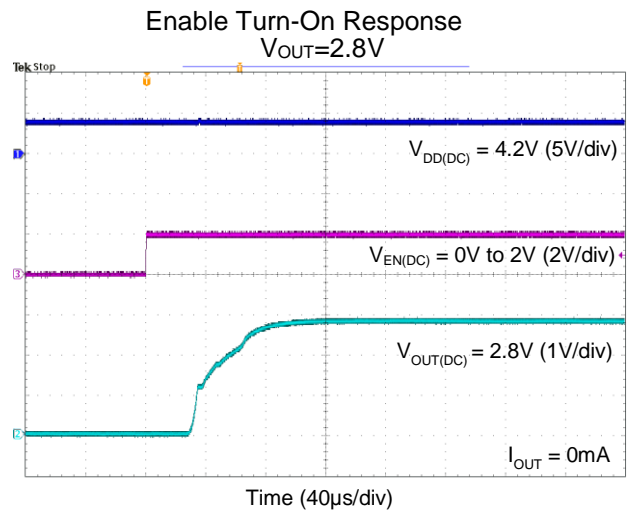
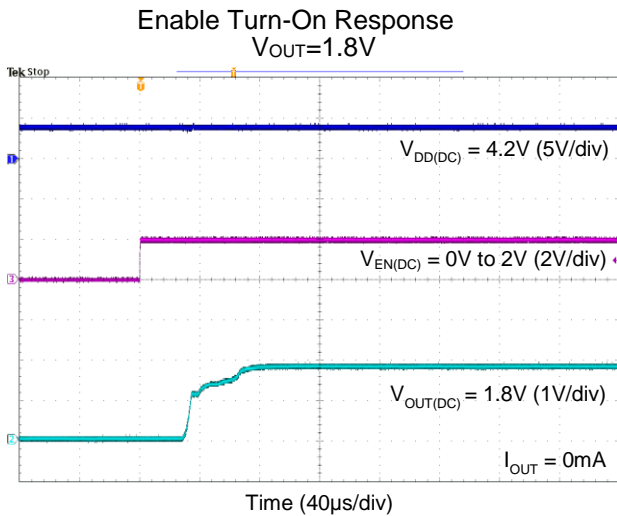
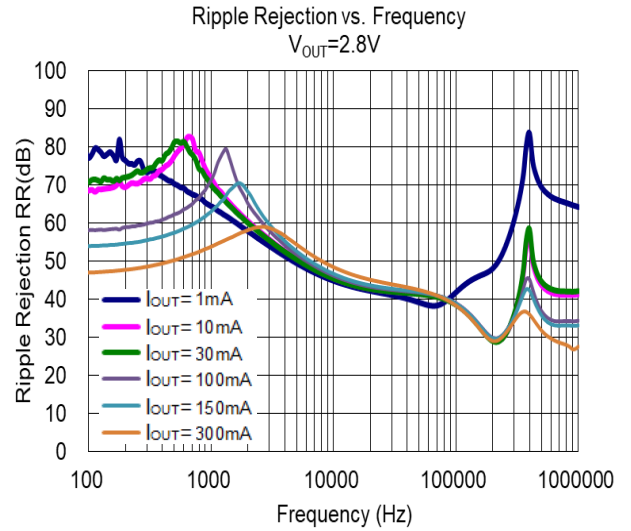
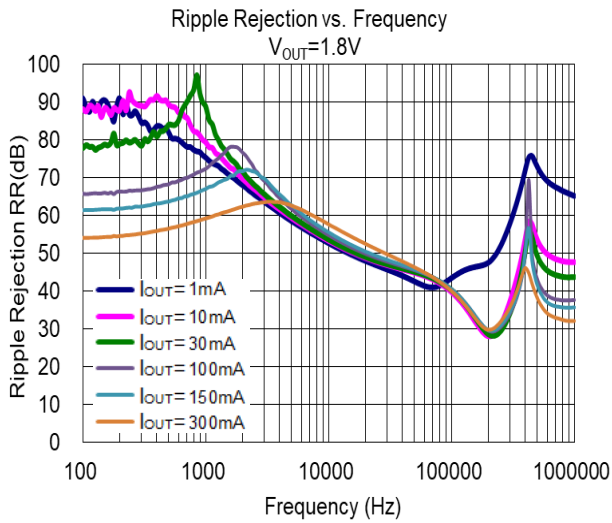
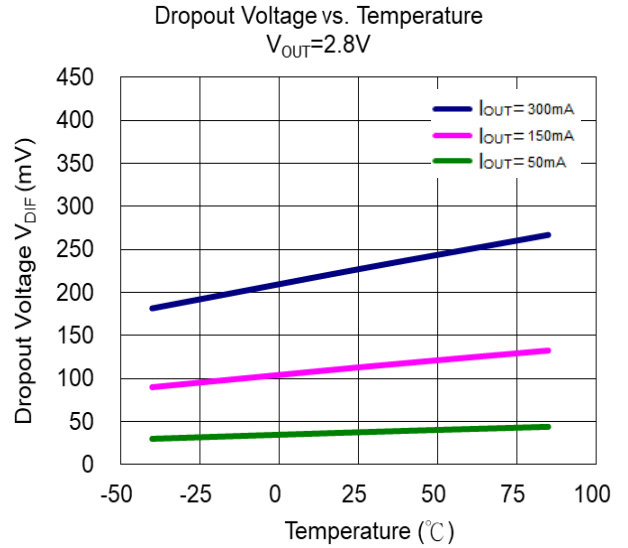
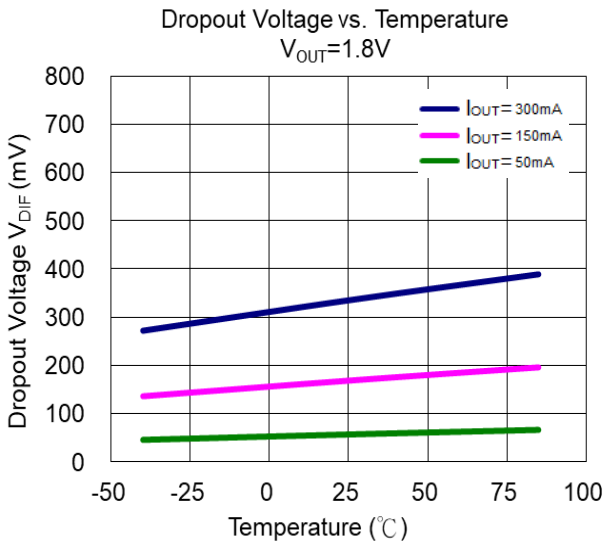

Typical Performance Characteristics (continued) (@T_A = +25°C, C_{IN} = 4.7μF, C_{OUT1} = C_{OUT2} = C_{OUT3} = C_{OUT4} = 1μF)

Enable Turn-On Response
V_{OUT}=1.8V

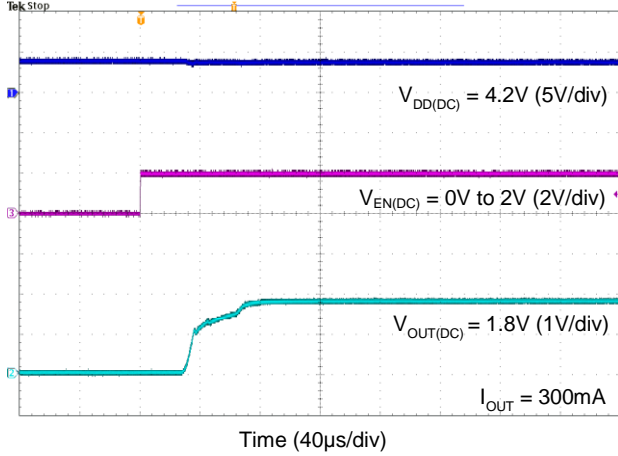

Enable Turn-On Response
V_{OUT}=2.8V

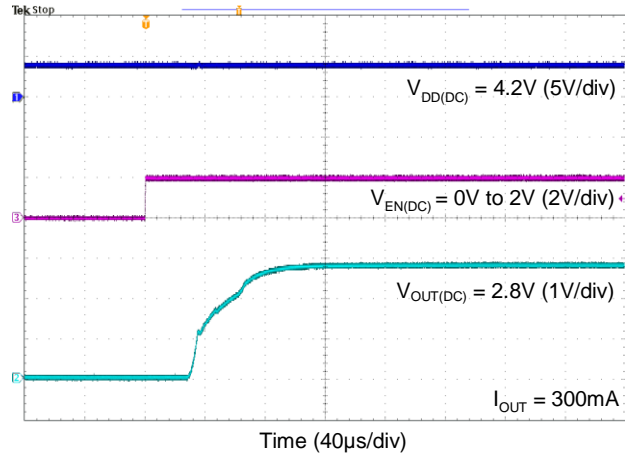

Enable Turn-Off Response
V_{OUT}=1.8V

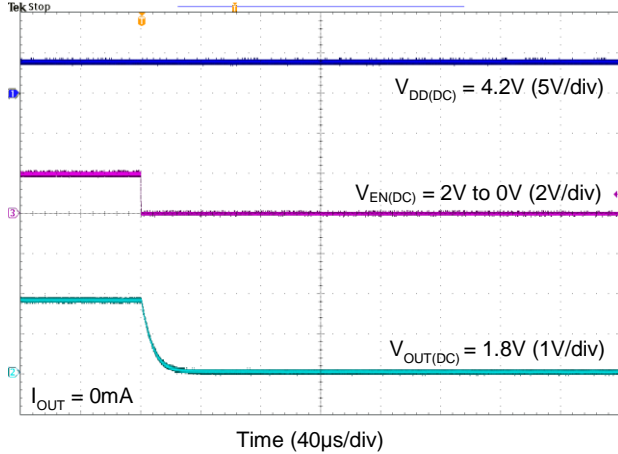

Enable Turn-Off Response
V_{OUT}=2.8V

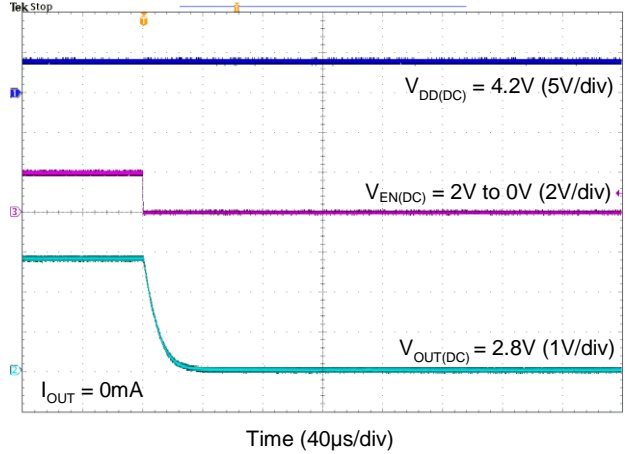

Enable Turn-Off Response
V_{OUT}=1.8V

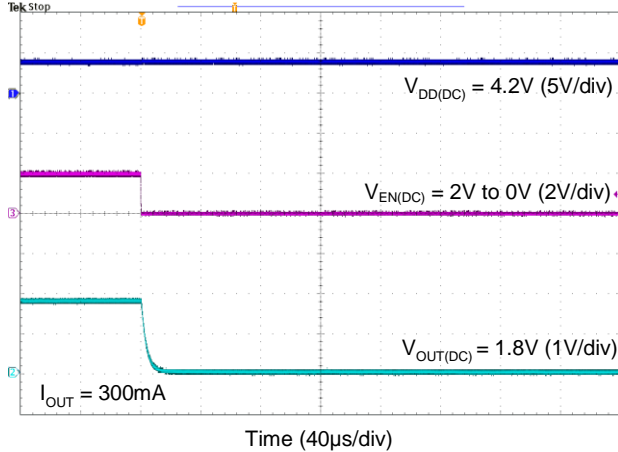

Enable Turn-Off Response
V_{OUT}=2.8V

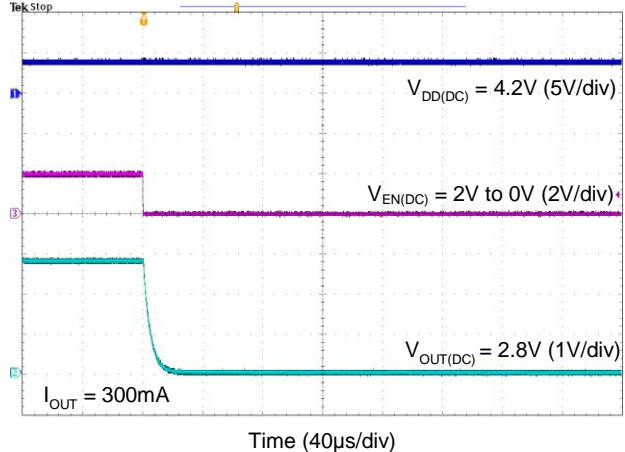

Typical Performance Characteristics (continued) (@T_A = +25°C, C_{IN} = 4.7μF, C_{OUT1} = C_{OUT2} = C_{OUT3} = C_{OUT4} = 1μF)

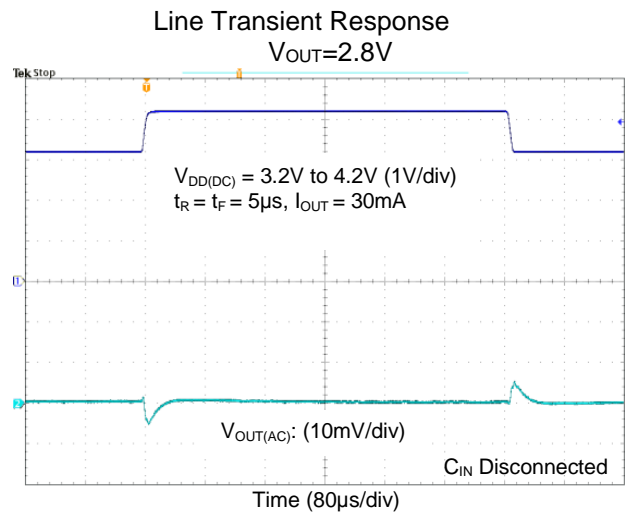
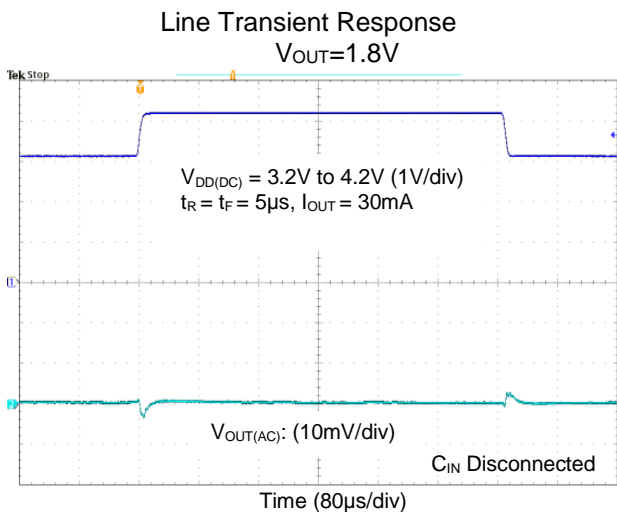
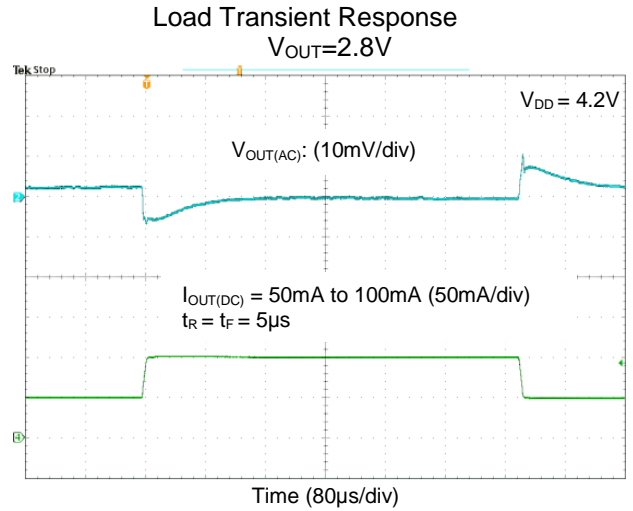
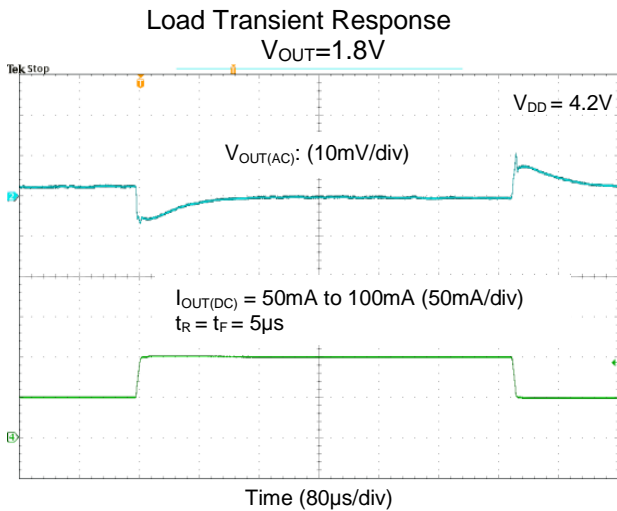
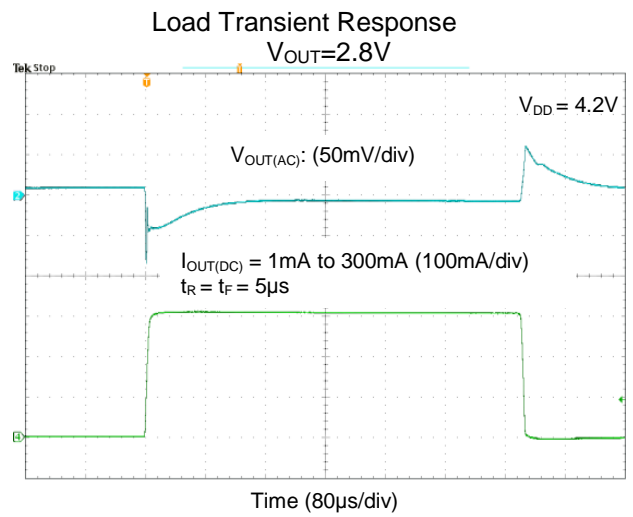
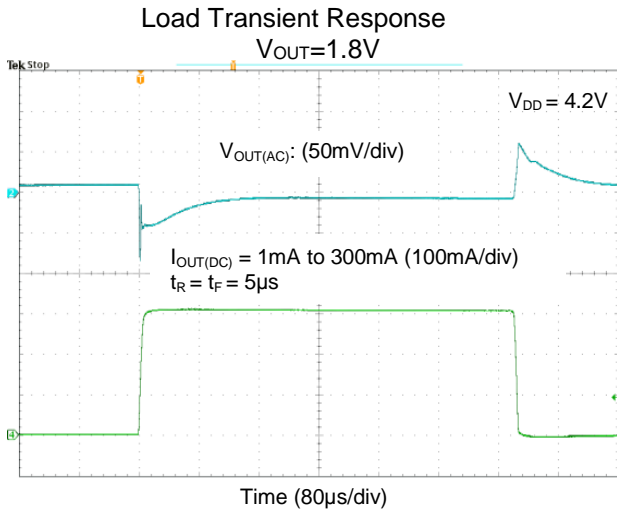

Application Information

Output Capacitor

An output capacitor (C_{OUT}) is needed to improve transient response and maintain stability. The AP7348 is stable with very small ceramic output capacitors. The ESR (equivalent series resistance) and capacitance drives the selection. If the application has large load variations, it is recommended to utilize low-ESR bulk capacitors. It is recommended to place ceramic capacitors as close as possible to the load and the ground pin and care should be taken to reduce the impedance in the layout.

Input Capacitor

To prevent the input voltage from dropping during load steps, it is recommended to utilize an input capacitor (C_{IN}). A minimum $4.7\mu\text{F}$ ceramic capacitor is recommended between V_{DD} and GND pins to decouple input power supply glitch. This input capacitor must be located as close as possible to the device to assure input stability and reduce noise. For PCB layout, a wide copper trace is required for both V_{DD} and GND pins.

Enable Control

The AP7348 is turned on by setting the EN pin high, and is turned off by pulling it low. When EN1 (EN2) pin pull high, the CH1 and CH3 (CH2 and CH4) are turned on at the same time. If this feature is not used, the EN pins should be tied to V_{DD} pin to keep the regulator output on at all times. To ensure proper operation, the signal source used to drive the EN pins must be able to swing above and below the specified turn-on/off voltage thresholds listed in the *Electrical Characteristics* section.

Short Circuit Protection

When V_{OUT} pin is short-circuit to GND, short circuit protection will be triggered and clamp the output current to approximately 55mA. This feature protects the regulator from overcurrent and damage due to overheating.

Layout Considerations

For good ground loop and stability, the input and output capacitors should be located close to the input, output, and ground pins of the device. The regulator ground pin should be connected to the external circuit ground to reduce voltage drop caused by trace impedance. Ground plane is generally used to reduce trace impedance. Wide trace should be used for large current paths from V_{IN} to V_{OUT} , and load circuit.

ESR vs. Output Current

Ceramic type output capacitor is recommended for this series; however, the other output capacitors with low ESR also can be used. The relations between I_{OUT} (Output Current) and ESR of an output capacitor are shown below. The stable region is marked as the hatched area in the graph.

Measurement conditions: Frequency Band: 10Hz to 2MHz, Temperature: -40°C to $+85^{\circ}\text{C}$.

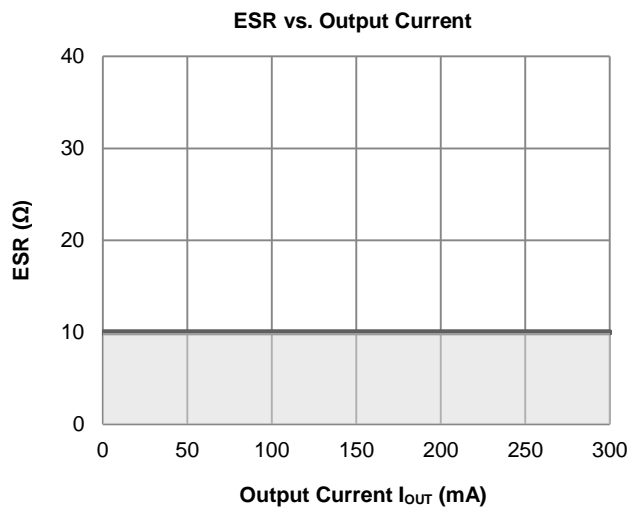

Ordering Information (Note 12)

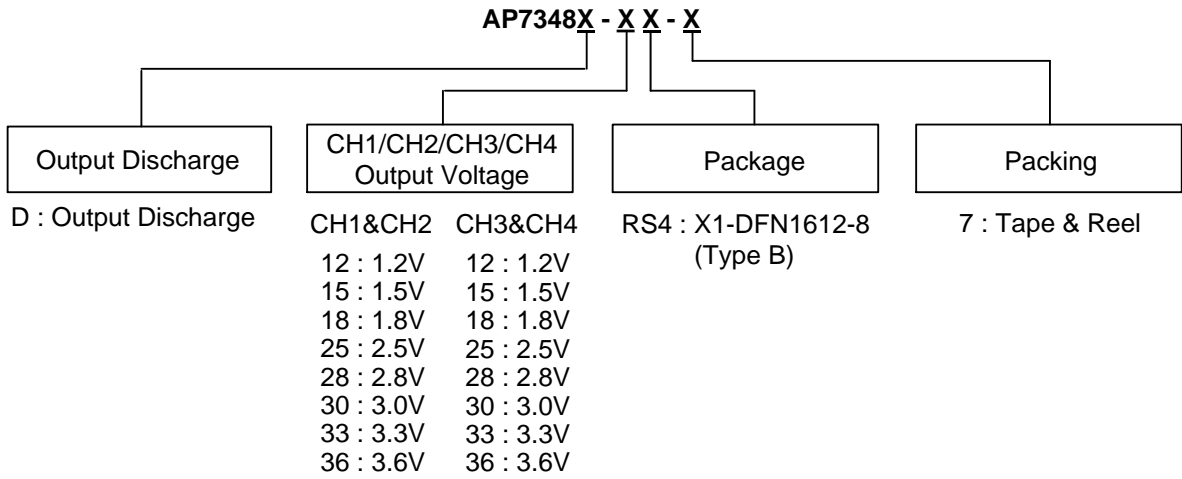

Part Number	Package Code	Packaging	7" Tape and Reel	
			Quantity	Part Number Suffix
AP7348D-XXXXRS4-7	Per marking table	X1-DFN1612-8 (Type B)	5,000/Tape & Reel	-7

Note: 12. For packaging details, go to our website at <https://www.diodes.com/design/support/packaging/diodes-packaging/>.

Marking Information

(1) X1-DFN1612-8 (Type B)

(Top View)

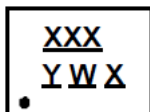

XXX : Identification Code
Y : Year : 0~9
W : Week : A~Z : 1~26 week;
 a~z : 27~52 week; z represents
 52 and 53 week
X : Internal code

Part Number	Package	Identification Code
AP7348D-1218RS4-7	X1-DFN1612-8 (Type B)	GAX
AP7348D-1528RS4-7 (Note 13)	X1-DFN1612-8 (Type B)	GAY
AP7348D-1815RS4-7 (Note 13)	X1-DFN1612-8 (Type B)	GAZ
AP7348D-1818RS4-7 (Note 13)	X1-DFN1612-8 (Type B)	GA2
AP7348D-1828RS4-7	X1-DFN1612-8 (Type B)	GA3
AP7348D-1833RS4-7	X1-DFN1612-8 (Type B)	GA4
AP7348D-2518RS4-7 (Note 13)	X1-DFN1612-8 (Type B)	GA5
AP7348D-2812RS4-7 (Note 13)	X1-DFN1612-8 (Type B)	GA6
AP7348D-2818RS4-7 (Note 13)	X1-DFN1612-8 (Type B)	GA7
AP7348D-2825RS4-7	X1-DFN1612-8 (Type B)	GA8
AP7348D-2833RS4-7	X1-DFN1612-8 (Type B)	GA9
AP7348D-3018RS4-7 (Note 13)	X1-DFN1612-8 (Type B)	GBA
AP7348D-3028RS4-7 (Note 13)	X1-DFN1612-8 (Type B)	GBB
AP7348D-3030RS4-7 (Note 13)	X1-DFN1612-8 (Type B)	GBC
AP7348D-3318RS4-7 (Note 13)	X1-DFN1612-8 (Type B)	GBD
AP7348D-3328RS4-7 (Note 13)	X1-DFN1612-8 (Type B)	GBE
AP7348D-3330RS4-7 (Note 13)	X1-DFN1612-8 (Type B)	GBF
AP7348D-3333RS4-7 (Note 13)	X1-DFN1612-8 (Type B)	GBG
AP7348D-3612RS4-7	X1-DFN1612-8 (Type B)	GBH

Note: 13. This voltage is supported upon request.

Package Outline Dimensions

Please see <http://www.diodes.com/package-outlines.html> for the latest version.

(1) Package Type: X1-DFN1612-8 (Type B)

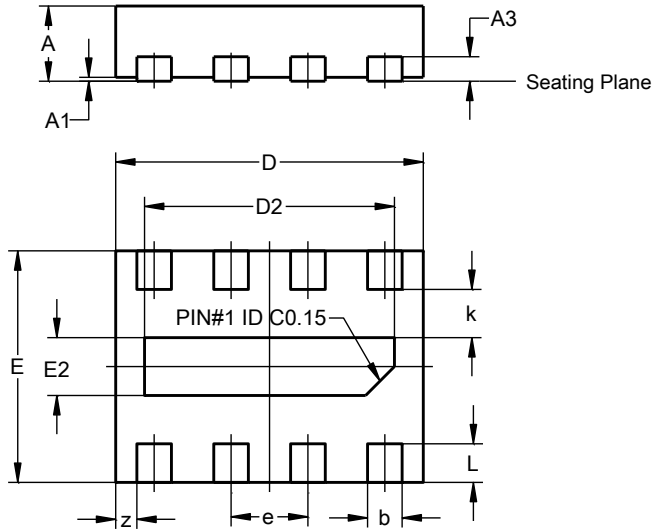

X1-DFN1612-8 (Type B)			
Dim	Min	Max	Typ
A	0.36	0.43	0.39
A1	0.00	0.05	0.02
A3	--	--	0.127
b	0.13	0.23	0.18
D	1.55	1.65	1.60
D2	1.20	1.40	1.30
E	1.15	1.25	1.20
E2	0.20	0.40	0.30
e	--	--	0.40
k	--	--	0.25
L	0.15	0.25	0.20
z	--	--	0.11
All Dimensions in mm			

Suggested Pad Layout

Please see <http://www.diodes.com/package-outlines.html> for the latest version.

(1) Package Type: X1-DFN1612-8 (Type B)

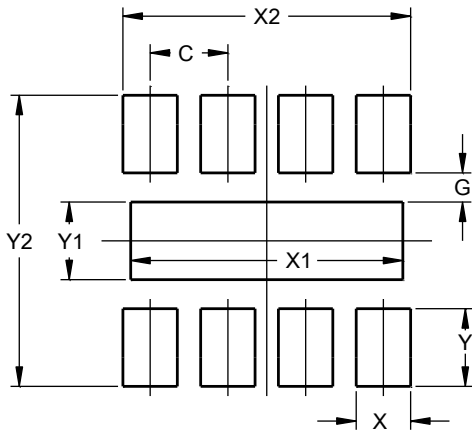

Dimensions	Value (in mm)
C	0.400
G	0.150
X	0.280
X1	1.400
X2	1.480
Y	0.400
Y1	0.400
Y2	1.500

Mechanical Data

- Moisture Sensitivity: Level 1 per J-STD-020
- Terminals: Finish- NiPdAu over Copper Leads, Solderable per JESD22-B102 Test Method 1 (e4)
- Weight: 2.359mg (Approximate)

Tape Orientation

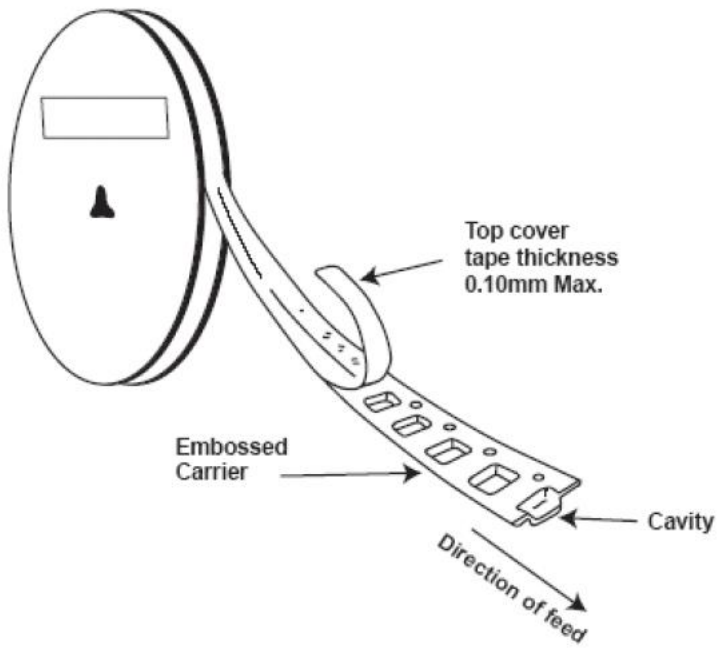
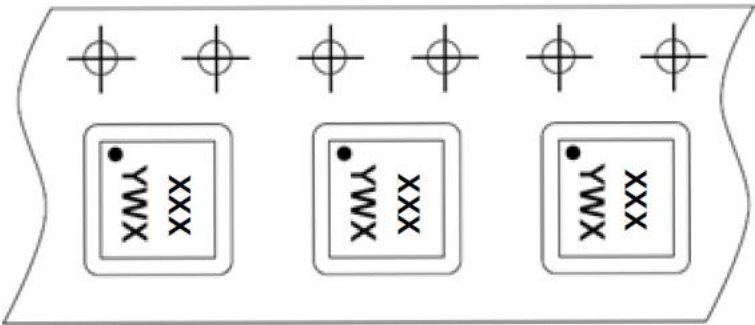

Note: 14. The taping orientation of the other package type can be found on our website at <https://www.diodes.com/assets/Packaging-Support-Docs/ap02007.pdf>.

IMPORTANT NOTICE

DIODES INCORPORATED MAKES NO WARRANTY OF ANY KIND, EXPRESS OR IMPLIED, WITH REGARDS TO THIS DOCUMENT, INCLUDING, BUT NOT LIMITED TO, THE IMPLIED WARRANTIES OF MERCHANTABILITY AND FITNESS FOR A PARTICULAR PURPOSE (AND THEIR EQUIVALENTS UNDER THE LAWS OF ANY JURISDICTION).

Diodes Incorporated and its subsidiaries reserve the right to make modifications, enhancements, improvements, corrections or other changes without further notice to this document and any product described herein. Diodes Incorporated does not assume any liability arising out of the application or use of this document or any product described herein; neither does Diodes Incorporated convey any license under its patent or trademark rights, nor the rights of others. Any Customer or user of this document or products described herein in such applications shall assume all risks of such use and will agree to hold Diodes Incorporated and all the companies whose products are represented on Diodes Incorporated website, harmless against all damages.

Diodes Incorporated does not warrant or accept any liability whatsoever in respect of any products purchased through unauthorized sales channel. Should Customers purchase or use Diodes Incorporated products for any unintended or unauthorized application, Customers shall indemnify and hold Diodes Incorporated and its representatives harmless against all claims, damages, expenses, and attorney fees arising out of, directly or indirectly, any claim of personal injury or death associated with such unintended or unauthorized application.

Products described herein may be covered by one or more United States, international or foreign patents pending. Product names and markings noted herein may also be covered by one or more United States, international or foreign trademarks.

This document is written in English but may be translated into multiple languages for reference. Only the English version of this document is the final and determinative format released by Diodes Incorporated.

LIFE SUPPORT

Diodes Incorporated products are specifically not authorized for use as critical components in life support devices or systems without the express written approval of the Chief Executive Officer of Diodes Incorporated. As used herein:

A. Life support devices or systems are devices or systems which:

1. are intended to implant into the body, or
2. support or sustain life and whose failure to perform when properly used in accordance with instructions for use provided in the labeling can be reasonably expected to result in significant injury to the user.

B. A critical component is any component in a life support device or system whose failure to perform can be reasonably expected to cause the failure of the life support device or to affect its safety or effectiveness.

Customers represent that they have all necessary expertise in the safety and regulatory ramifications of their life support devices or systems, and acknowledge and agree that they are solely responsible for all legal, regulatory and safety-related requirements concerning their products and any use of Diodes Incorporated products in such safety-critical, life support devices or systems, notwithstanding any devices- or systems-related information or support that may be provided by Diodes Incorporated. Further, Customers must fully indemnify Diodes Incorporated and its representatives against any damages arising out of the use of Diodes Incorporated products in such safety-critical, life support devices or systems.

Copyright © 2020, Diodes Incorporated

www.diodes.com

Mouser Electronics

Authorized Distributor

Click to View Pricing, Inventory, Delivery & Lifecycle Information:

Diodes Incorporated:

[AP7348D-3018RS4-7](#) [AP7348D-3318RS4-7](#) [AP7348D-2812RS4-7](#) [AP7348D-3330RS4-7](#) [AP7348D-3028RS4-7](#)
[AP7348D-1833RS4-7](#) [AP7348D-2518RS4-7](#) [AP7348D-1828RS4-7](#) [AP7348D-3328RS4-7](#) [AP7348D-1815RS4-7](#)
[AP7348D-3333RS4-7](#) [AP7348D-3030RS4-7](#) [AP7348D-2818RS4-7](#) [AP7348D-1818RS4-7](#) [AP7348D-2825RS4-7](#)
[AP7348D-2833RS4-7](#) [AP7348D-1528RS4-7](#) [AP7348D-3612RS4-7](#) [AP7348D-1218RS4-7](#)