

62 mm C-Series module with TRENCHSTOP™ IGBT7 and emitter controlled 7 diode

Features

- Electrical features
 - $V_{CES} = 1200\text{ V}$
 - $I_{C\text{nom}} = 800\text{ A} / I_{CRM} = 1600\text{ A}$
 - TRENCHSTOP™ IGBT7
 - $V_{CE,sat}$ with positive temperature coefficient
- Mechanical features
 - Standard housing
 - 4 kV AC 1 min insulation
 - High creepage and clearance distances
 - High power density
 - Isolated base plate
 - Package with CTI > 400



Typical appearance

Potential applications

- Three-level applications
- Commercial agriculture vehicles
- High-power converters
- Motor drives
- Servo drives
- Solar applications
- UPS systems

Product validation

- Qualified for industrial applications according to the relevant tests of IEC 60747, 60749 and 60068

Description

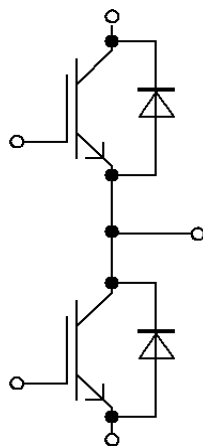

Table of contents

	Description	1
	Features	1
	Potential applications	1
	Product validation	1
	Table of contents	2
1	Package	3
2	IGBT, Inverter	3
3	Diode, Inverter	5
4	Characteristics diagrams	7
5	Circuit diagram	11
6	Package outlines	12
7	Module label code	13
	Revision history	14
	Disclaimer	15

1 Package

Table 1 Insulation coordination

Parameter	Symbol	Note or test condition	Values	Unit
Isolation test voltage	V_{ISOL}	RMS, $f = 50 \text{ Hz}$, $t = 60 \text{ s}$	4.0	kV
Material of module baseplate			Cu	
Internal isolation		basic insulation (class 1, IEC 61140)	Al_2O_3	
Creepage distance	d_{Creep}	terminal to heatsink	29.0	mm
Creepage distance	d_{Creep}	terminal to terminal	23.0	mm
Clearance	d_{Clear}	terminal to heatsink	23.0	mm
Clearance	d_{Clear}	terminal to terminal	11.0	mm
Comparative tracking index	CTI		> 400	
Relative thermal index (electrical)	RTI	housing	140	°C

Table 2 Characteristic values

Parameter	Symbol	Note or test condition	Values			Unit
			Min.	Typ.	Max.	
Stray inductance module	L_{sCE}			20		nH
Module lead resistance, terminals - chip	$R_{CC'+EE'}$	$T_C = 25^\circ\text{C}$, per switch		0.5		mΩ
Storage temperature	T_{stg}		-40		125	°C
Mounting torque for module mounting	M	- Mounting according to valid application note	M5, Screw	3	6	Nm
Terminal connection torque	M	- Mounting according to valid application note	M6, Screw	2.5	5	Nm
Weight	G			340		g

2 IGBT, Inverter

Table 3 Maximum rated values

Parameter	Symbol	Note or test condition	Values	Unit
Collector-emitter voltage	V_{CES}	$T_{vj} = 25^\circ\text{C}$	1200	V
Continuous DC collector current	I_{CDC}	$T_{vj\max} = 175^\circ\text{C}$ $T_C = 90^\circ\text{C}$	800	A
Maximum RMS module DC-terminal current	I_{tRMS}	$T_{Terminal} = 115^\circ\text{C}$, $T_C = 90^\circ\text{C}$	650	A
		$T_{Terminal} = 115^\circ\text{C}$, $T_C = 115^\circ\text{C}$	600	

(table continues...)
 Datasheet

Table 3 (continued) Maximum rated values

Parameter	Symbol	Note or test condition	Values	Unit
Repetitive peak collector current	I_{CRM}	t_p limited by $T_{vj\ op}$	1600	A
Gate-emitter peak voltage	V_{GES}		± 20	V

Table 4 Characteristic values

Parameter	Symbol	Note or test condition	Values			Unit
			Min.	Typ.	Max.	
Collector-emitter saturation voltage	$V_{CE\ sat}$	$I_C = 800\ A, V_{GE} = 15\ V$	$T_{vj} = 25\ ^\circ C$	1.50	1.75	V
			$T_{vj} = 125\ ^\circ C$	1.65		
			$T_{vj} = 150\ ^\circ C$	1.70		
			$T_{vj} = 175\ ^\circ C$	1.75		
Gate threshold voltage	V_{Geth}	$I_C = 16\ mA, V_{CE} = V_{GE}, T_{vj} = 25\ ^\circ C$	5.15	5.80	6.45	V
Gate charge	Q_G	$V_{GE} = \pm 15\ V, V_{CC} = 600\ V$		12.8		μC
Internal gate resistor	R_{Gint}	$T_{vj} = 25\ ^\circ C$		0.43		Ω
Input capacitance	C_{ies}	$f = 100\ kHz, T_{vj} = 25\ ^\circ C, V_{CE} = 25\ V, V_{GE} = 0\ V$		122		nF
Reverse transfer capacitance	C_{res}	$f = 100\ kHz, T_{vj} = 25\ ^\circ C, V_{CE} = 25\ V, V_{GE} = 0\ V$		0.6		nF
Collector-emitter cut-off current	I_{CES}	$V_{CE} = 1200\ V, V_{GE} = 0\ V$			0.1	mA
Gate-emitter leakage current	I_{GES}	$V_{CE} = 0\ V, V_{GE} = 20\ V, T_{vj} = 25\ ^\circ C$			100	nA
Turn-on delay time (inductive load)	t_{don}	$I_C = 800\ A, V_{CC} = 600\ V, V_{GE} = \pm 15\ V, R_{Gon} = 0.51\ \Omega$	$T_{vj} = 25\ ^\circ C$	0.500		μs
			$T_{vj} = 125\ ^\circ C$	0.517		
			$T_{vj} = 150\ ^\circ C$	0.522		
			$T_{vj} = 175\ ^\circ C$	0.527		
Rise time (inductive load)	t_r	$I_C = 800\ A, V_{CC} = 600\ V, V_{GE} = \pm 15\ V, R_{Gon} = 0.51\ \Omega$	$T_{vj} = 25\ ^\circ C$	0.065		μs
			$T_{vj} = 125\ ^\circ C$	0.073		
			$T_{vj} = 150\ ^\circ C$	0.075		
			$T_{vj} = 175\ ^\circ C$	0.077		
Turn-off delay time (inductive load)	t_{doff}	$I_C = 800\ A, V_{CC} = 600\ V, V_{GE} = \pm 15\ V, R_{Goff} = 0.51\ \Omega$	$T_{vj} = 25\ ^\circ C$	0.544		μs
			$T_{vj} = 125\ ^\circ C$	0.628		
			$T_{vj} = 150\ ^\circ C$	0.652		
			$T_{vj} = 175\ ^\circ C$	0.675		

(table continues...)

Table 4 (continued) Characteristic values

Parameter	Symbol	Note or test condition	Values			Unit
			Min.	Typ.	Max.	
Fall time (inductive load)	t_f	$I_C = 800 \text{ A}, V_{CC} = 600 \text{ V}, V_{GE} = \pm 15 \text{ V}, R_{Goff} = 0.51 \Omega$	$T_{vj} = 25 \text{ }^\circ\text{C}$		0.122	μs
			$T_{vj} = 125 \text{ }^\circ\text{C}$		0.260	
			$T_{vj} = 150 \text{ }^\circ\text{C}$		0.310	
			$T_{vj} = 175 \text{ }^\circ\text{C}$		0.360	
Turn-on energy loss per pulse	E_{on}	$I_C = 800 \text{ A}, V_{CC} = 600 \text{ V}, L_\sigma = 25 \text{ nH}, V_{GE} = \pm 15 \text{ V}, R_{Gon} = 0.51 \Omega, di/dt = 8700 \text{ A}/\mu\text{s} (T_{vj} = 175 \text{ }^\circ\text{C})$	$T_{vj} = 25 \text{ }^\circ\text{C}$		27.2	mJ
			$T_{vj} = 125 \text{ }^\circ\text{C}$		42.7	
			$T_{vj} = 150 \text{ }^\circ\text{C}$		48.7	
			$T_{vj} = 175 \text{ }^\circ\text{C}$		54.6	
Turn-off energy loss per pulse	E_{off}	$I_C = 800 \text{ A}, V_{CC} = 600 \text{ V}, L_\sigma = 25 \text{ nH}, V_{GE} = \pm 15 \text{ V}, R_{Goff} = 0.51 \Omega, dv/dt = 3400 \text{ V}/\mu\text{s} (T_{vj} = 175 \text{ }^\circ\text{C})$	$T_{vj} = 25 \text{ }^\circ\text{C}$		69.7	mJ
			$T_{vj} = 125 \text{ }^\circ\text{C}$		108	
			$T_{vj} = 150 \text{ }^\circ\text{C}$		120	
			$T_{vj} = 175 \text{ }^\circ\text{C}$		132	
SC data	I_{SC}	$V_{GE} \leq 15 \text{ V}, V_{CC} = 800 \text{ V}, V_{CEmax} = V_{CES} - L_{sCE} * di/dt$	$t_p \leq 8 \mu\text{s}, T_{vj} = 150 \text{ }^\circ\text{C}$		3000	A
			$t_p \leq 6 \mu\text{s}, T_{vj} = 175 \text{ }^\circ\text{C}$		2700	
Thermal resistance, junction to case	R_{thJC}	per IGBT			0.0483	K/W
Thermal resistance, case to heat sink	R_{thCH}	per IGBT		0.0251		K/W
Temperature under switching conditions	$T_{vj op}$		-40		175	$^\circ\text{C}$

Note: $T_{vj op} > 150 \text{ }^\circ\text{C}$ is allowed for operation at overload conditions. For detailed specifications, please refer to AN 2018-14.

3 Diode, Inverter

Table 5 Maximum rated values

Parameter	Symbol	Note or test condition	Values	Unit
Repetitive peak reverse voltage	V_{RRM}	$T_{vj} = 25 \text{ }^\circ\text{C}$	1200	V
Continuous DC forward current	I_F		800	A
Repetitive peak forward current	I_{FRM}	$t_p = 1 \text{ ms}$	1600	A

(table continues...)

Table 5 (continued) Maximum rated values

Parameter	Symbol	Note or test condition	Values	Unit	
I^2t - value	I^2t	$t_p = 10 \text{ ms}, V_R = 0 \text{ V}$	$T_{vj} = 125 \text{ }^\circ\text{C}$	53000	A^2s
			$T_{vj} = 175 \text{ }^\circ\text{C}$	41000	

Table 6 Characteristic values

Parameter	Symbol	Note or test condition	Values			Unit	
			Min.	Typ.	Max.		
Forward voltage	V_F	$I_F = 800 \text{ A}, V_{GE} = 0 \text{ V}$	$T_{vj} = 25 \text{ }^\circ\text{C}$		1.80	2.10	V
			$T_{vj} = 125 \text{ }^\circ\text{C}$		1.70		
			$T_{vj} = 150 \text{ }^\circ\text{C}$		1.65		
			$T_{vj} = 175 \text{ }^\circ\text{C}$		1.60		
Peak reverse recovery current	I_{RM}	$V_{CC} = 600 \text{ V}, I_F = 800 \text{ A}, V_{GE} = -15 \text{ V}, -di_F/dt = 8700 \text{ A}/\mu\text{s} (T_{vj} = 175 \text{ }^\circ\text{C})$	$T_{vj} = 25 \text{ }^\circ\text{C}$		540		A
			$T_{vj} = 125 \text{ }^\circ\text{C}$		720		
			$T_{vj} = 150 \text{ }^\circ\text{C}$		765		
			$T_{vj} = 175 \text{ }^\circ\text{C}$		810		
Recovered charge	Q_r	$V_{CC} = 600 \text{ V}, I_F = 800 \text{ A}, V_{GE} = -15 \text{ V}, -di_F/dt = 8700 \text{ A}/\mu\text{s} (T_{vj} = 175 \text{ }^\circ\text{C})$	$T_{vj} = 25 \text{ }^\circ\text{C}$		62		μC
			$T_{vj} = 125 \text{ }^\circ\text{C}$		117		
			$T_{vj} = 150 \text{ }^\circ\text{C}$		137		
			$T_{vj} = 175 \text{ }^\circ\text{C}$		156		
Reverse recovery energy	E_{rec}	$V_{CC} = 600 \text{ V}, I_F = 800 \text{ A}, V_{GE} = -15 \text{ V}, -di_F/dt = 8700 \text{ A}/\mu\text{s} (T_{vj} = 175 \text{ }^\circ\text{C})$	$T_{vj} = 25 \text{ }^\circ\text{C}$		27.9		mJ
			$T_{vj} = 125 \text{ }^\circ\text{C}$		54.5		
			$T_{vj} = 150 \text{ }^\circ\text{C}$		63.3		
			$T_{vj} = 175 \text{ }^\circ\text{C}$		72.1		
Thermal resistance, junction to case	R_{thJC}	per diode			0.0892	K/W	
Thermal resistance, case to heat sink	R_{thCH}	per diode		0.0333		K/W	
Temperature under switching conditions	T_{vjop}		-40		175	$^\circ\text{C}$	

Note: $T_{vjop} > 150 \text{ }^\circ\text{C}$ is allowed for operation at overload conditions. For detailed specifications, please refer to AN 2018-14.

4 Characteristics diagrams

Output characteristic (typical), IGBT, Inverter

$I_C = f(V_{CE})$
 $V_{GE} = 15 \text{ V}$

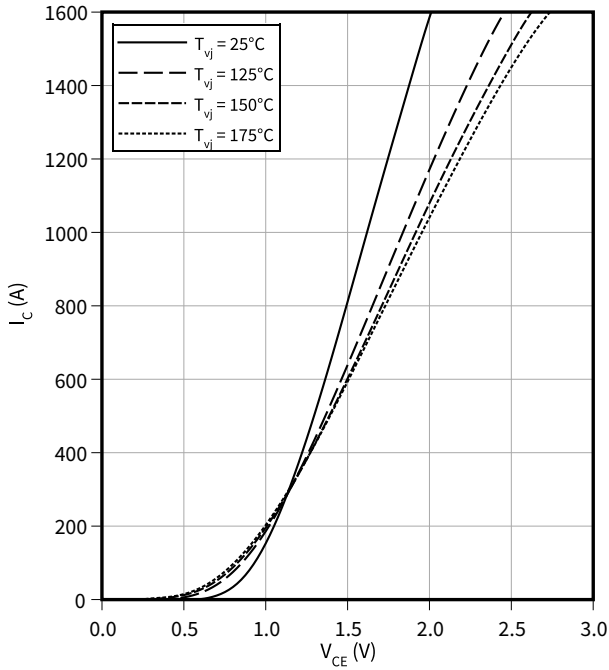

Output characteristic field (typical), IGBT, Inverter

$I_C = f(V_{CE})$
 $T_{vj} = 175 \text{ °C}$

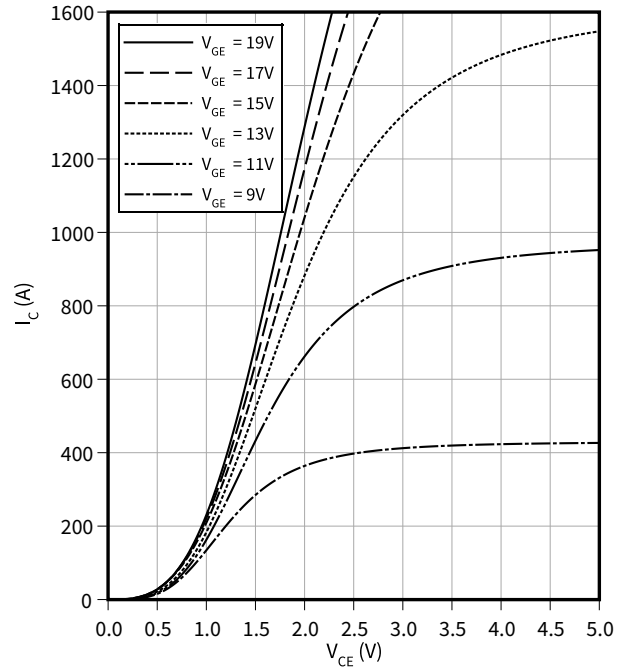

Transfer characteristic (typical), IGBT, Inverter

$I_C = f(V_{GE})$
 $V_{CE} = 20 \text{ V}$

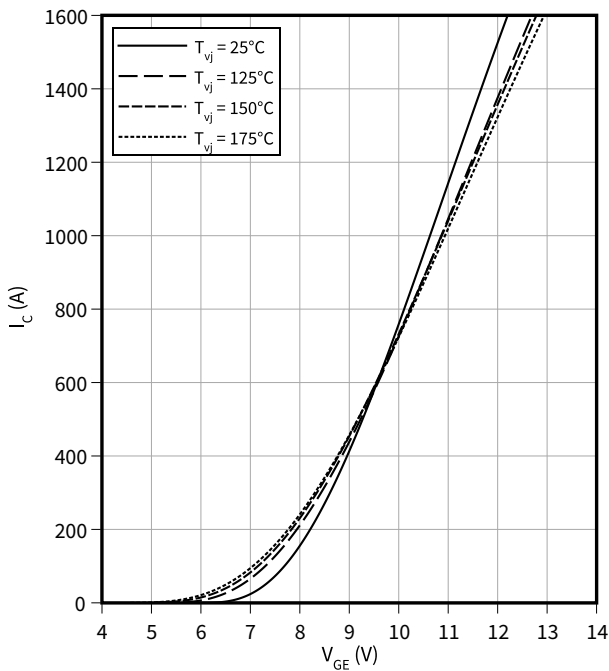

Switching losses (typical), IGBT, Inverter

$E = f(I_C)$
 $R_{Goff} = 0.51 \text{ } \Omega$, $R_{Gon} = 0.51 \text{ } \Omega$, $V_{CC} = 600 \text{ V}$, $V_{GE} = \pm 15 \text{ V}$

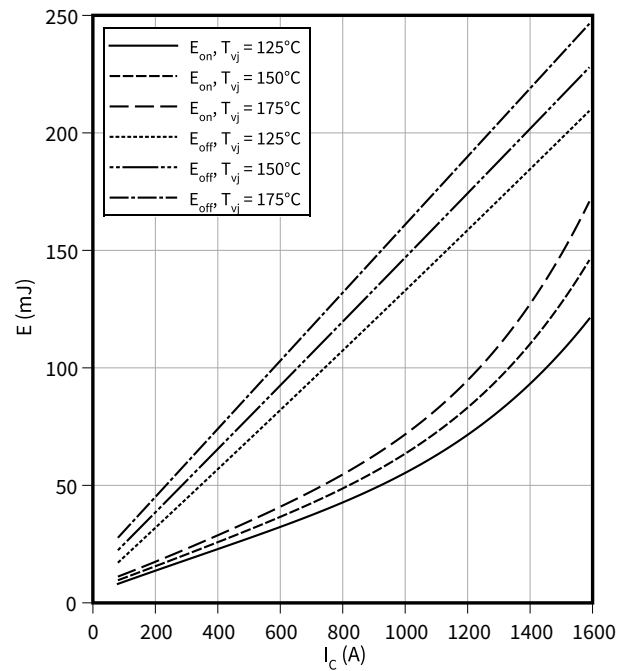

4 Characteristics diagrams

Switching losses (typical), IGBT, Inverter

$E = f(R_G)$

$I_C = 800 \text{ A}$, $V_{CC} = 600 \text{ V}$, $V_{GE} = \pm 15 \text{ V}$

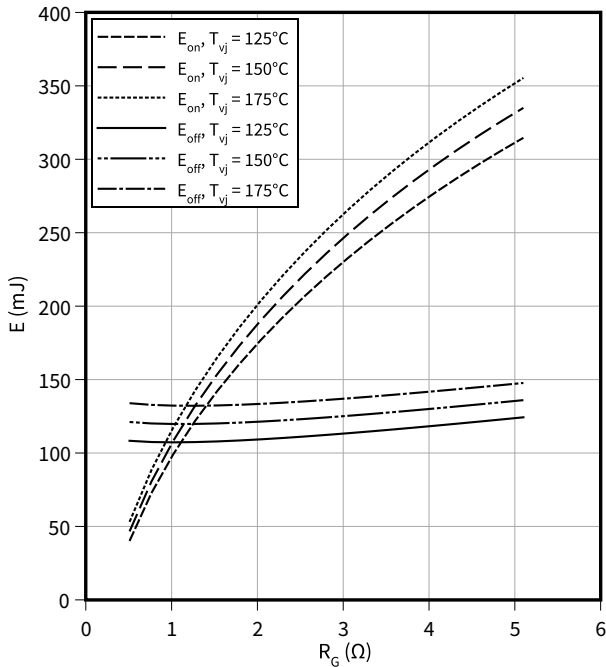

Switching times (typical), IGBT, Inverter

$t = f(I_C)$

$R_{Goff} = 0.51 \Omega$, $R_{Gon} = 0.51 \Omega$, $V_{CC} = 600 \text{ V}$, $V_{GE} = \pm 15 \text{ V}$, $T_{vj} = 175 \text{ °C}$

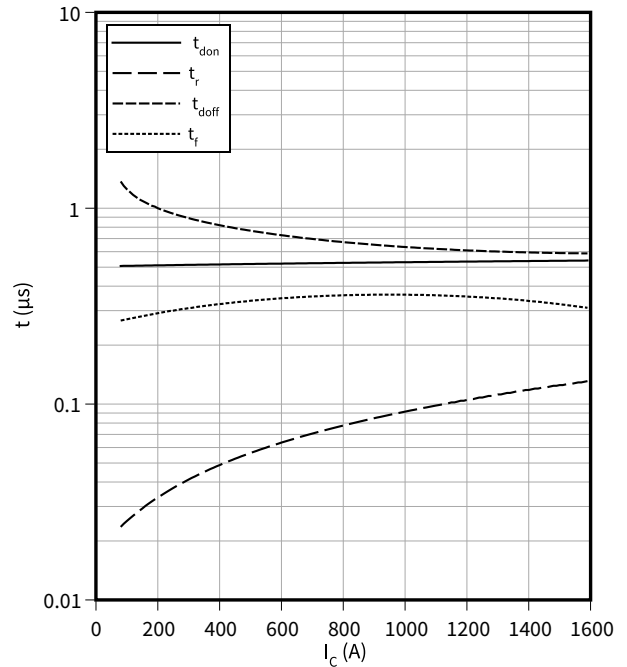

Switching times (typical), IGBT, Inverter

$t = f(R_G)$

$I_C = 800 \text{ A}$, $V_{CC} = 600 \text{ V}$, $V_{GE} = \pm 15 \text{ V}$, $T_{vj} = 175 \text{ °C}$

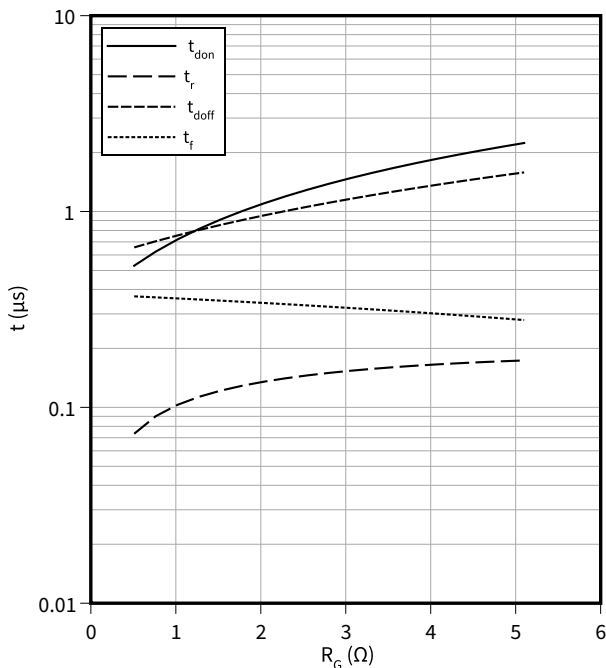

Voltage slope (typical), IGBT, Inverter

$dv/dt = f(R_G)$

$I_C = 800 \text{ A}$, $V_{CC} = 600 \text{ V}$, $V_{GE} = \pm 15 \text{ V}$, $T_{vj} = 25 \text{ °C}$

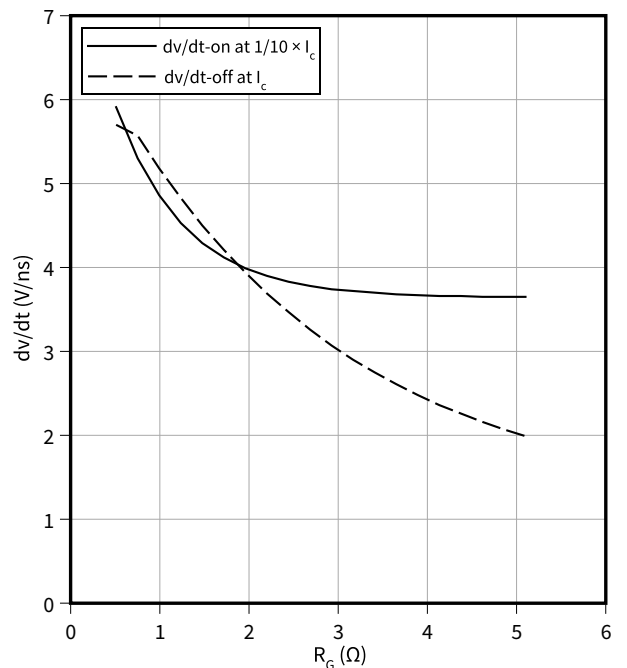

4 Characteristics diagrams

Transient thermal impedance, IGBT, Inverter

$Z_{th} = f(t)$

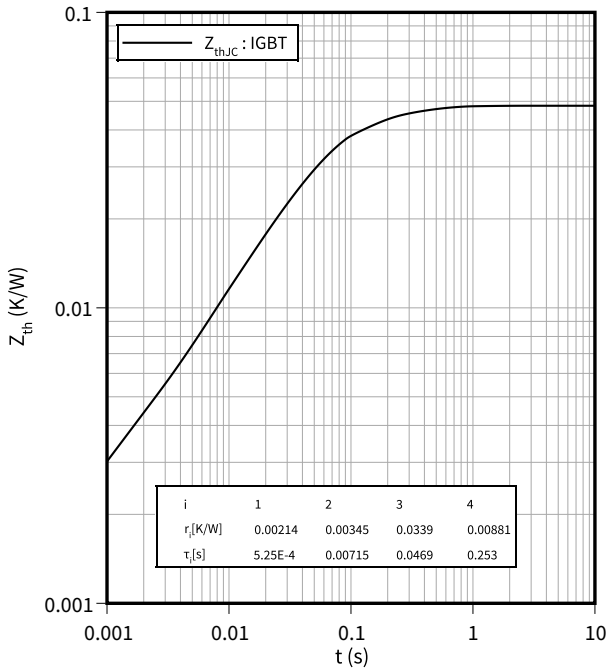

Reverse bias safe operating area (RBSOA), IGBT, Inverter

$I_C = f(V_{CE})$

$R_{Goff} = 0.51 \Omega, V_{GE} = \pm 15 V, T_{vj} = 175 \text{ }^\circ\text{C}$

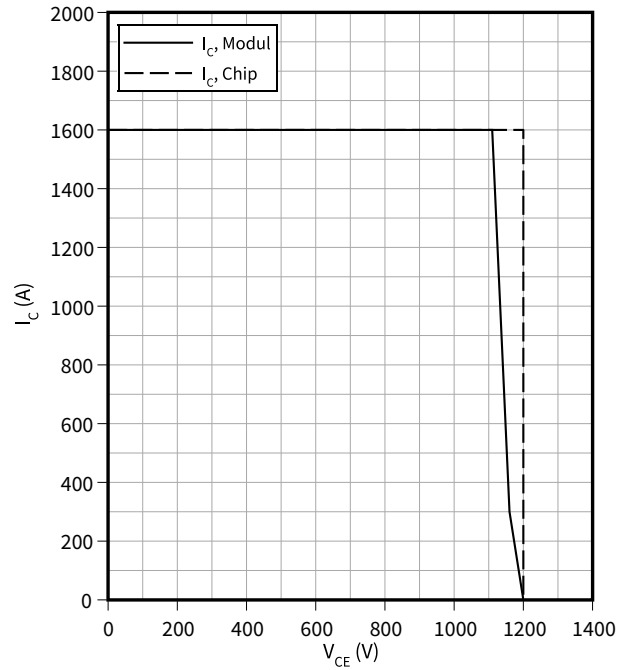

Capacity characteristic (typical), IGBT, Inverter

$C = f(V_{CE})$

$f = 100 \text{ kHz}, V_{GE} = 0 V, T_{vj} = 25 \text{ }^\circ\text{C}$

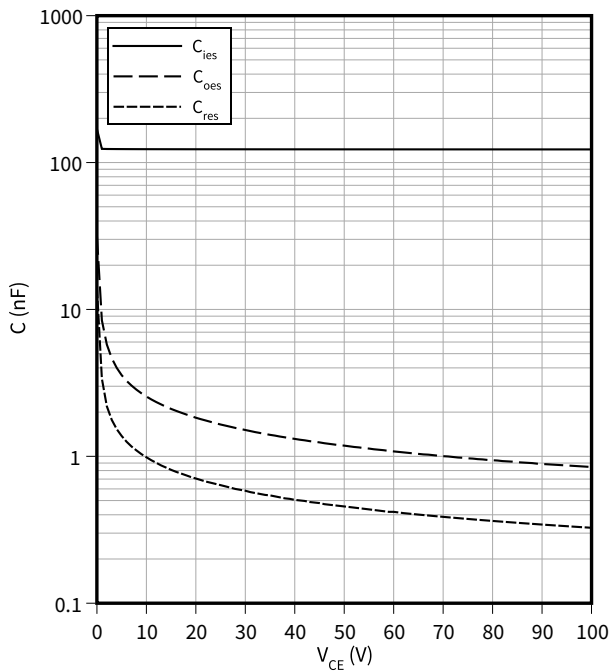

Gate charge characteristic (typical), IGBT, Inverter

$V_{GE} = f(Q_G)$

$I_C = 800 A, T_{vj} = 25 \text{ }^\circ\text{C}$

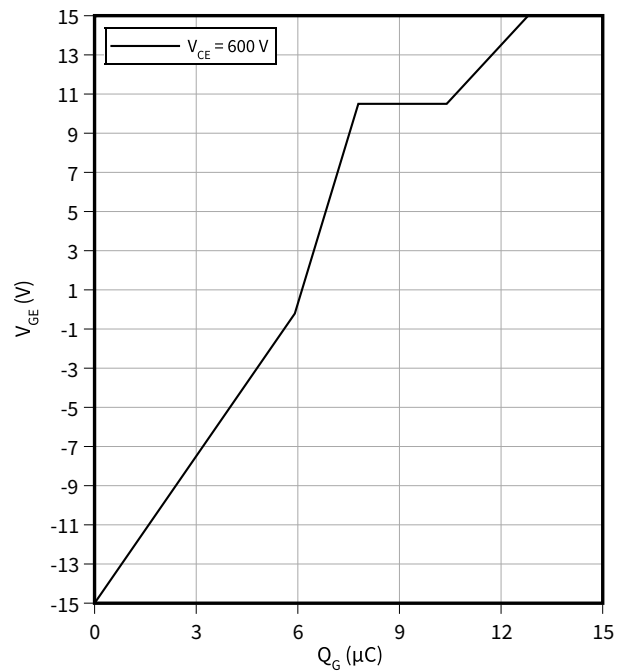

4 Characteristics diagrams

Forward characteristic (typical), Diode, Inverter

$I_F = f(V_F)$

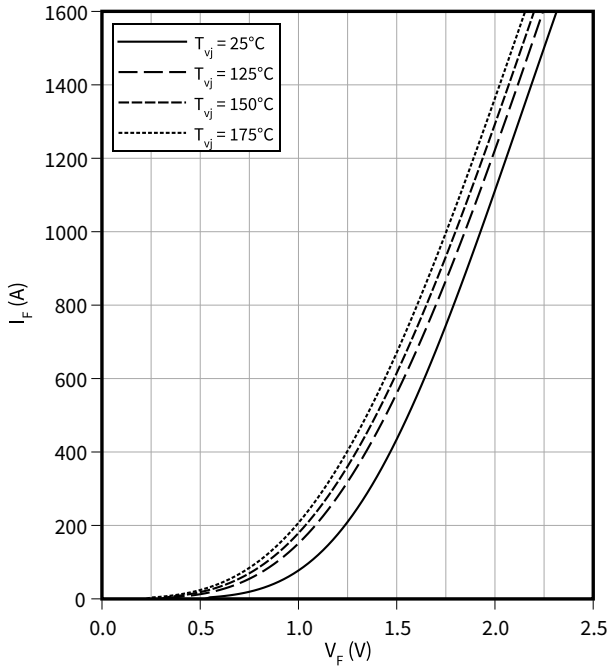

Switching losses (typical), Diode, Inverter

$E_{rec} = f(I_F)$

$R_{Gon} = 0.51 \Omega, V_{CE} = 600 V$

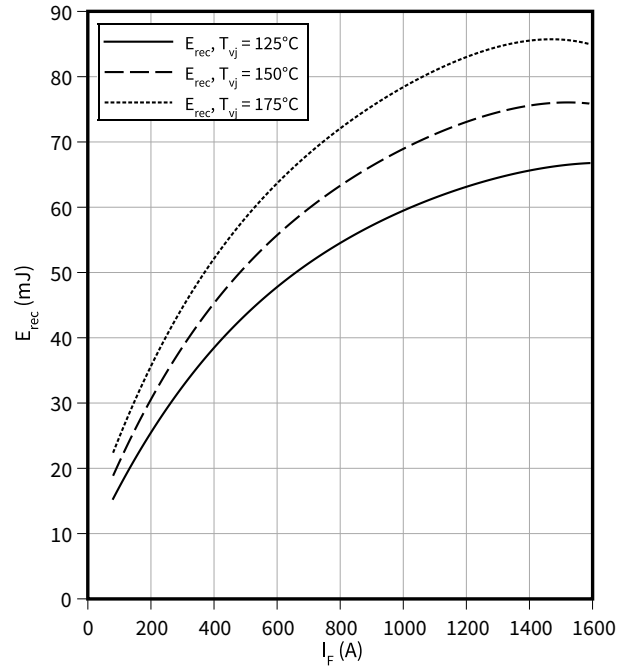

Switching losses (typical), Diode, Inverter

$E_{rec} = f(R_G)$

$V_{CE} = 600 V, I_F = 800 A$

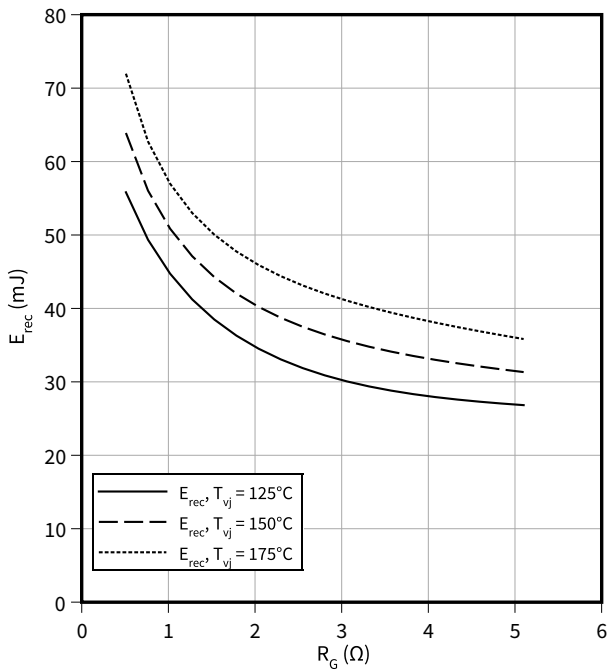

Transient thermal impedance, Diode, Inverter

$Z_{th} = f(t)$

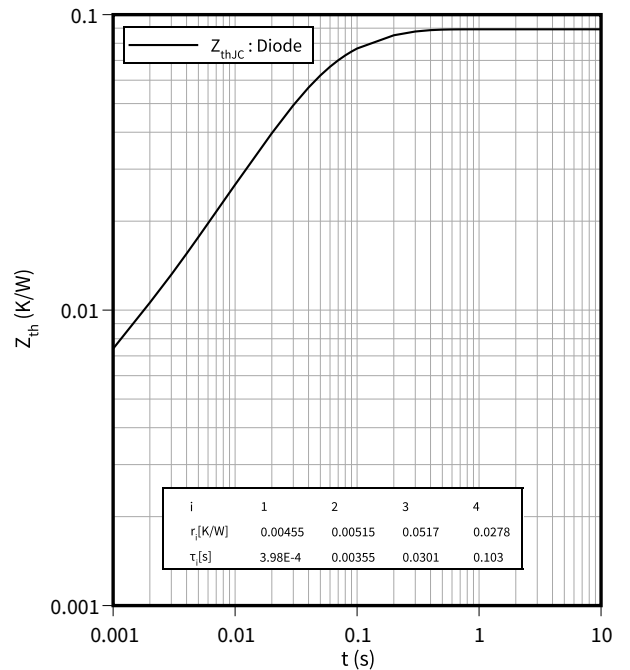

5 Circuit diagram

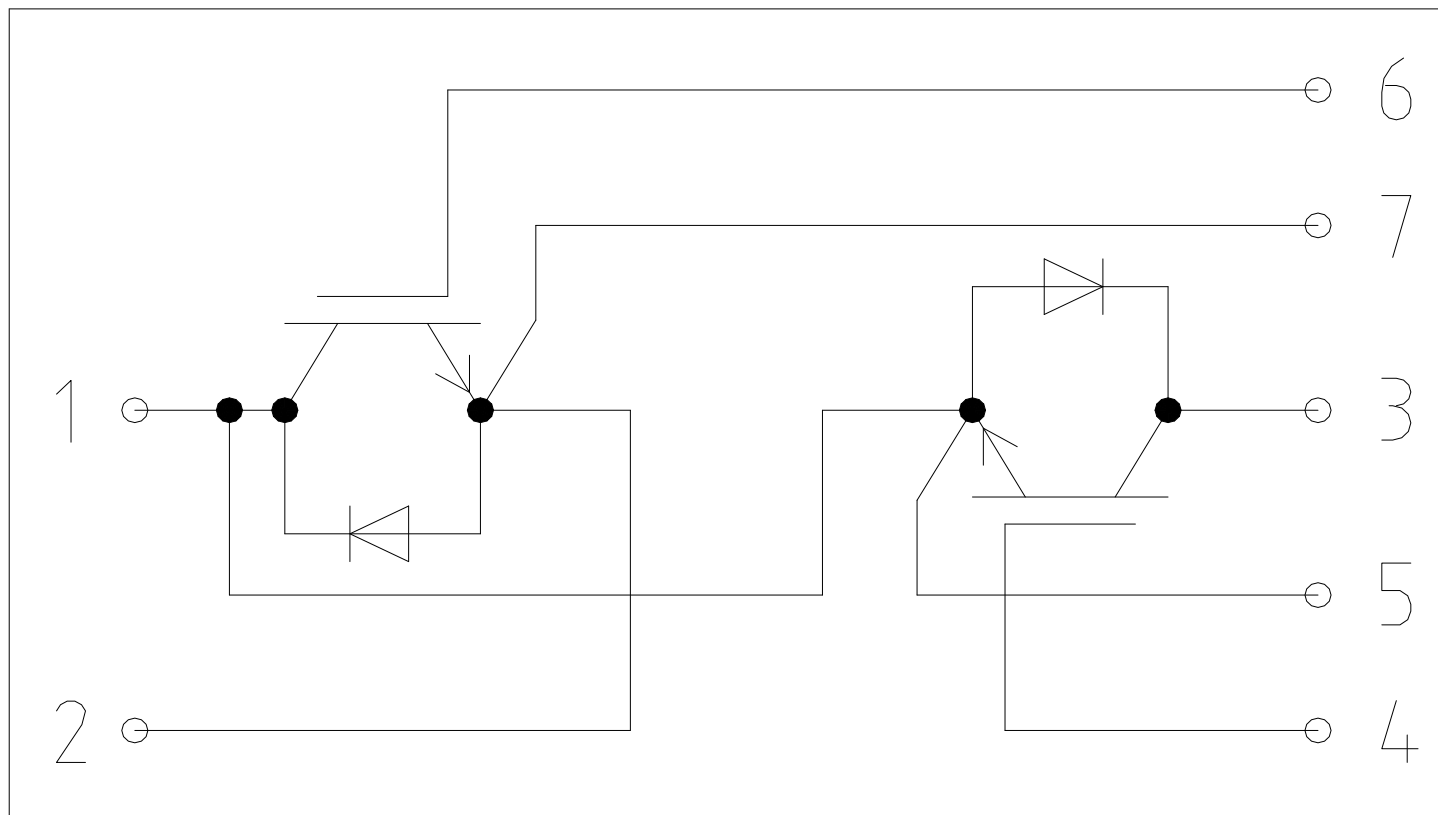

Figure 1

6 Package outlines

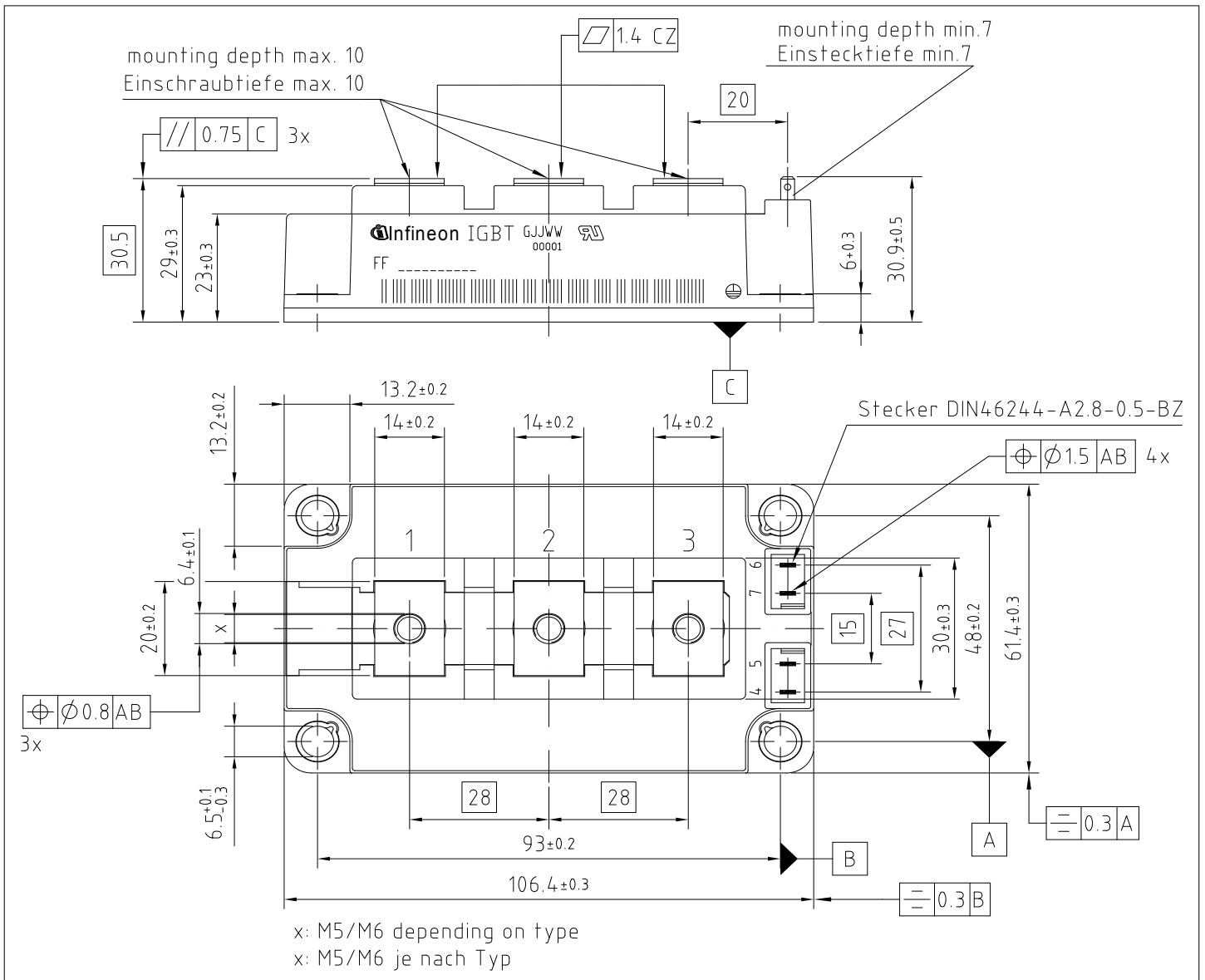

Figure 2

7 Module label code

Module label code			
Code format	Data Matrix	Barcode Code128	
Encoding	ASCII text	Code Set A	
Symbol size	16x16	23 digits	
Standard	IEC24720 and IEC16022	IEC8859-1	
Code content	<i>Content</i>	<i>Digit</i>	<i>Example</i>
	Module serial number	1 - 5	71549
	Module material number	6 - 11	142846
	Production order number	12 - 19	55054991
	Date code (production year)	20 - 21	15
	Date code (production week)	22 - 23	30
Example	 		
	71549142846550549911530		71549142846550549911530

Figure 3

Revision history

Document revision	Date of release	Description of changes
V1.0	2020-06-19	Target datasheet
V1.1	2020-08-21	Target datasheet
n/a	2020-09-01	Datasheet migrated to a new system with a new layout and new revision number schema: target or preliminary datasheet = 0.xy; final datasheet = 1.xy
0.10	2021-09-02	Target datasheet
0.30	2021-11-15	Target datasheet
0.40	2021-12-17	Preliminary datasheet
1.00	2022-05-11	Final datasheet

Trademarks

All referenced product or service names and trademarks are the property of their respective owners.

Edition 2022-05-11

Published by

Infineon Technologies AG

81726 Munich, Germany

© 2022 Infineon Technologies AG

All Rights Reserved.

Do you have a question about any aspect of this document?

Email: erratum@infineon.com

Document reference

IFX-AAJ653-006

Important notice

The information given in this document shall in no event be regarded as a guarantee of conditions or characteristics ("Beschaffheitsgarantie").

With respect to any examples, hints or any typical values stated herein and/or any information regarding the application of the product, Infineon Technologies hereby disclaims any and all warranties and liabilities of any kind, including without limitation warranties of non-infringement of intellectual property rights of any third party.

In addition, any information given in this document is subject to customer's compliance with its obligations stated in this document and any applicable legal requirements, norms and standards concerning customer's products and any use of the product of Infineon Technologies in customer's applications.

The data contained in this document is exclusively intended for technically trained staff. It is the responsibility of customer's technical departments to evaluate the suitability of the product for the intended application and the completeness of the product information given in this document with respect to such application.

Warnings

Due to technical requirements products may contain dangerous substances. For information on the types in question please contact your nearest Infineon Technologies office.

Except as otherwise explicitly approved by Infineon Technologies in a written document signed by authorized representatives of Infineon Technologies, Infineon Technologies' products may not be used in any applications where a failure of the product or any consequences of the use thereof can reasonably be expected to result in personal injury.

Mouser Electronics

Authorized Distributor

Click to View Pricing, Inventory, Delivery & Lifecycle Information:

[Infineon:](#)

[FF800R12KE7HPSA1](#)