

Anti-Vandal KeyLock Switch



Features

- Anti-vandal key lock switch with ring for location or power indication
- Impact resistance rating of IK02
- Front panel protection rating of IP40
- Constructed from varnished stainless steel



Specification

Switching Configuration	1CO
LED Colour	Red / Green
LED Voltage	12 V
Rated Insulation Voltage	250 V
Thermal Current (Ith)	5 A max.
Rated Voltage	12 V
Rated Current	Resistive Load - 1 A Inductive Load - 700 mA
Switch Type	90°, 2 Position
Mechanical Life	1000000 Cycles min.
Electrical Life	50000 Cycles min.
Contact Resistance	50 mOhm max.
Insulation Resistance	1 GOhm min.
Dielectric Strength	1.5 kV RMS 50 Hz 1 min.
Operating Temperature	-25 ... 55 °C
Torque	0.8 Nm max.
Protection Rating	IP40
Terminal Type	Pin Terminal (2.8 x 0.5 mm) Included Quick Connector (2.4 x 0.3 mm)

Material Specification

Bushing & Button	Stainless Steel with Varnished Polished
Contact	Silver Alloy
Base	PBT, PA

Drawing

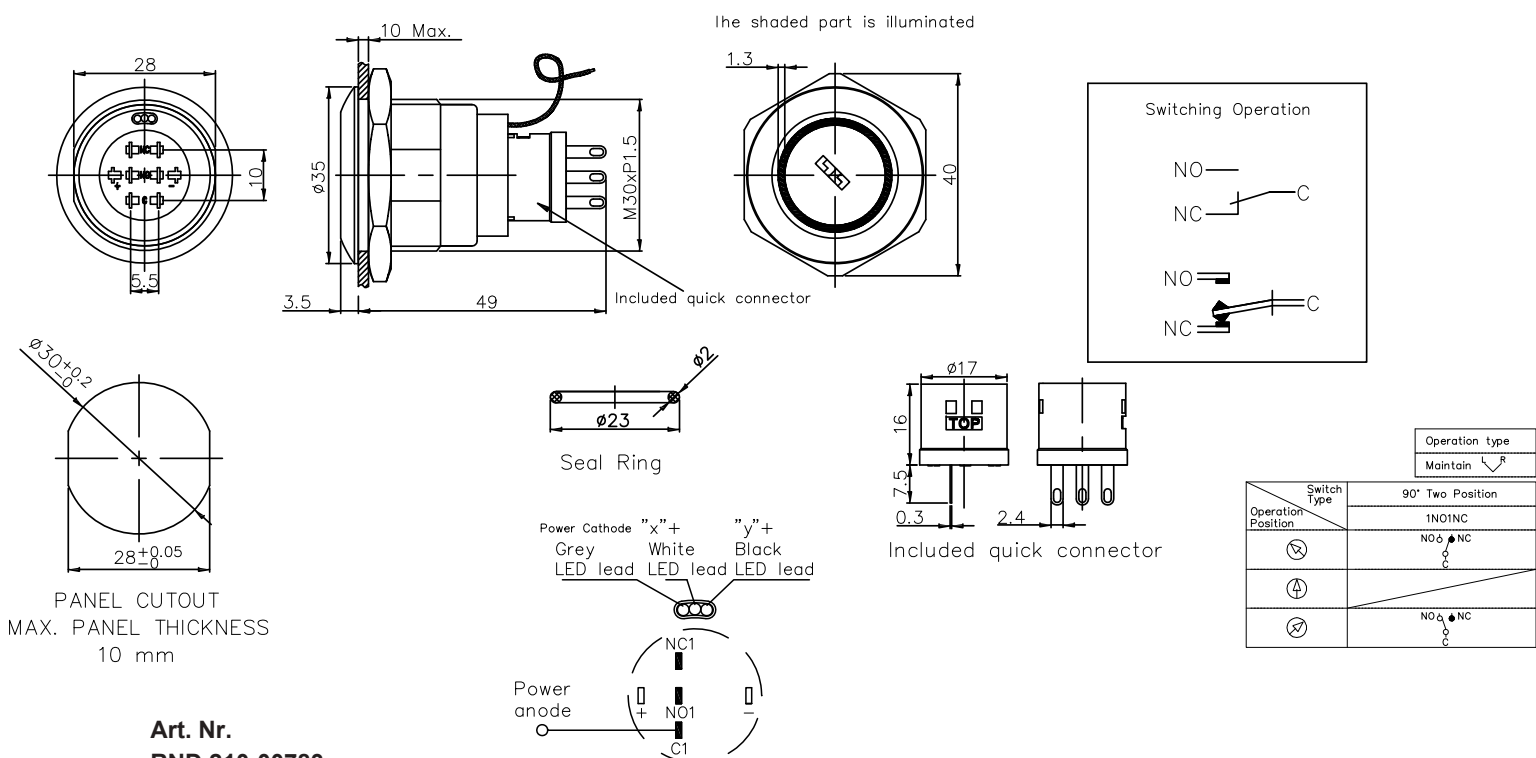

Art. Nr.
RND 210-00783