

PART NAME: KNOB

SCALE: 1:1

DATE: 8/13/13

DR. BY: JAM



DESIGNERS & MANUFACTURERS
OF KNOBS, HANDLES, CAPS &
CUSTOM PLASTIC COMPONENTS

P/N 1230-J

THIS DRAWING IS THE PROPERTY OF DAVIES MOLDING COMPANY, IS SUBMITTED SOLELY AS A DESIGN OR ENGINEERING PROJECT.
WE ACCEPT NO RESPONSIBILITY WHATSOEVER FOR THE PRACTICAL APPLICATION OF THE PIECES MADE TO THIS DESIGN.

MOLD #	1230
CAVITY	1230
CORE	1230
PIN	1230-J

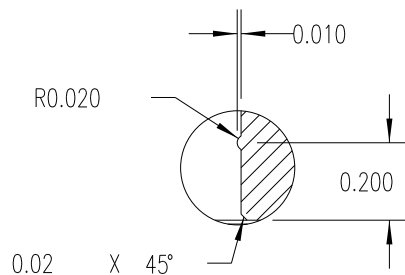
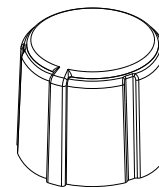
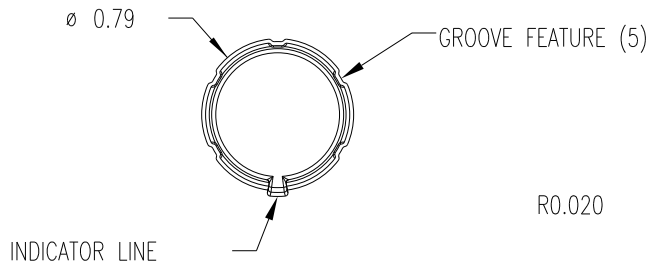

DETAIL A
SCALE 2 : 1

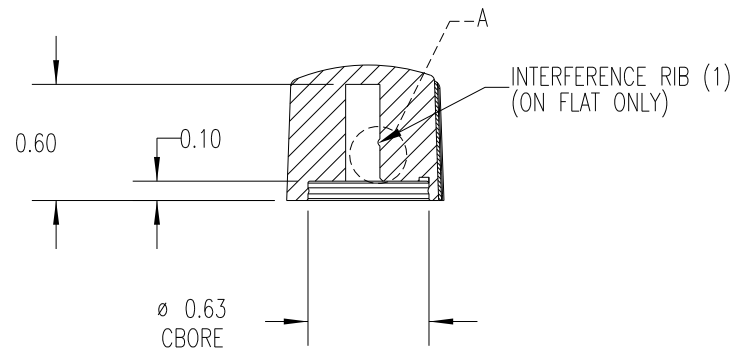
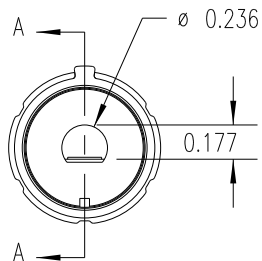
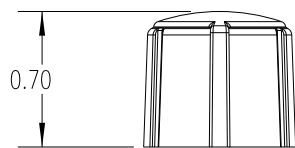

SECTION A-A

SUBSTRATE MATERIAL: POLYPROPYLENE (CLD)
COLOR: WHITE (PC23083)

OVERMOLD MATERIAL: TPE (TPE3)
COLOR: BLACK

TOLERANCES: UNLESS OTHERWISE SPECIFIED	DO NOT SCALE DRAWING				
DECIMALS: X.XXX ± .005 X.XX ± .015	MM: X.XX ± 0.15MM X.X ± 0.4MM				
FRACTIONS ± 1/64	ANG. ± 1°	CHANGES			

Mouser Electronics

Authorized Distributor

Click to View Pricing, Inventory, Delivery & Lifecycle Information:

[Davies Molding:](#)

[1230-J](#)