

IRWIN®

Record.

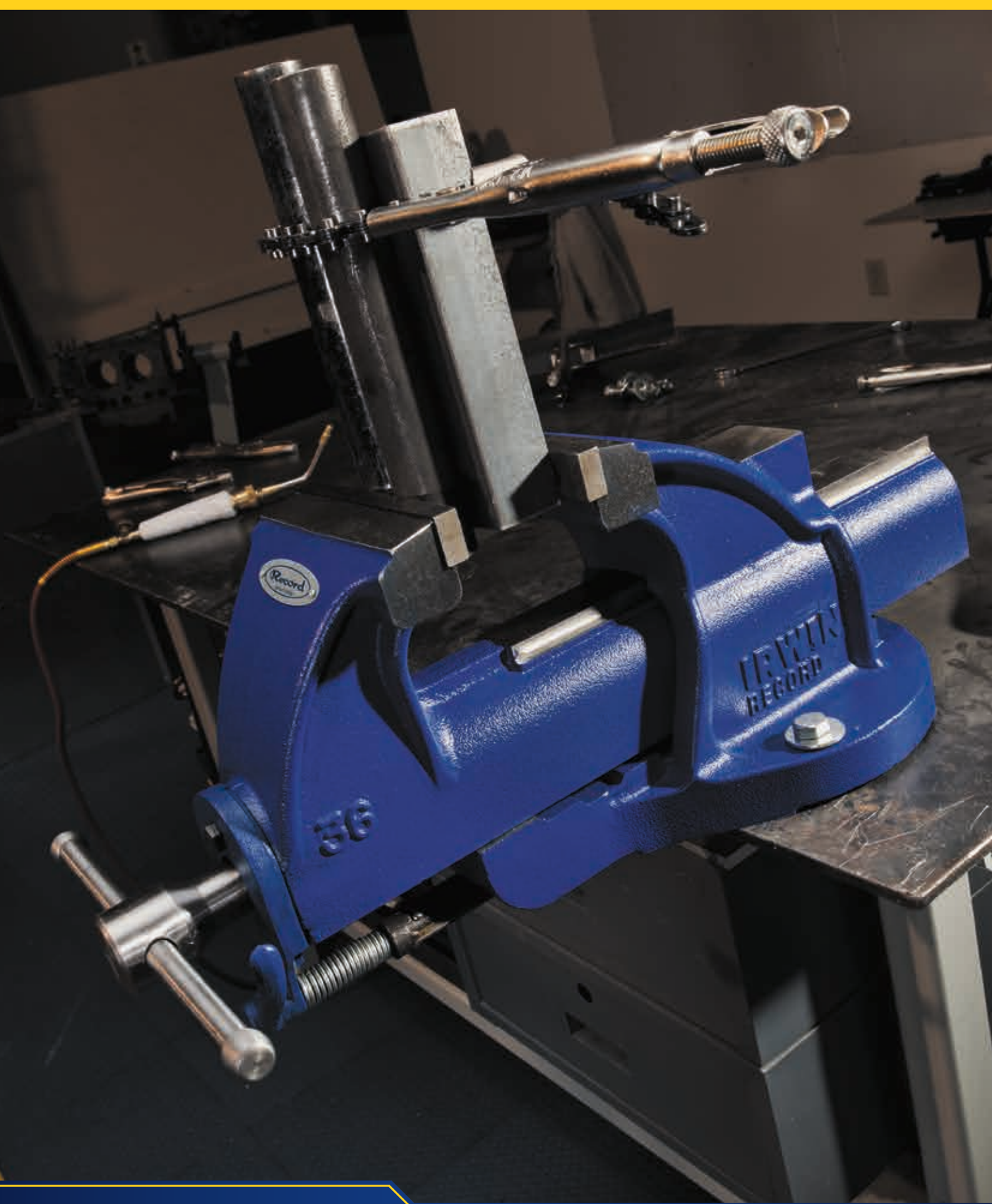

VICES AND ACCESSORIES

IRWIN® Record® Vices have become the benchmark by which all other vices are measured. Design, choice of materials and manufacturing disciplines each set very high standards which, for the end user, translate into safety, reliability and excellent value.

ENGINEERS' VICE - LIFETIME VICE RANGE

Designed for heavy-duty work, these vices are made from S.G. Ductile Iron with an integral anvil for shaping and beating, together with a quick-release mechanism for rapid slide adjustment. The reinforced body and slide, large diameter main screw allow these vices with the working strength and resilience to withstand the most demanding work. Fitters' vices are similar in design to Engineers' however made of close grained gray iron instead of S.G. Ductile Iron. Full line of replacement parts available.

ENGINEERS' AND FITTERS' VICES

1. IRWIN® ENGINEERS' VICES

Are made from S.G. Ductile Iron with high-impact resistance, guaranteeing strength and long life.

2. SAFETY STOP

Prevents the slide from being separated from the body.

3. FULLY MACHINED

On all load-bearing surfaces for smooth and troublefree operation.

4. FUSED STEEL HANDLE

Will bend before the vice can be overstressed.

5. QUICK-RELEASE MECHANISM

Disengages the main screw, allowing rapid movement of the slide.

6. UNBREAKABLE SG IRON NUT

Can be replaced when worn.

7. INTEGRAL ANVIL

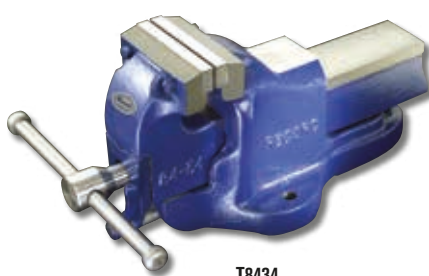
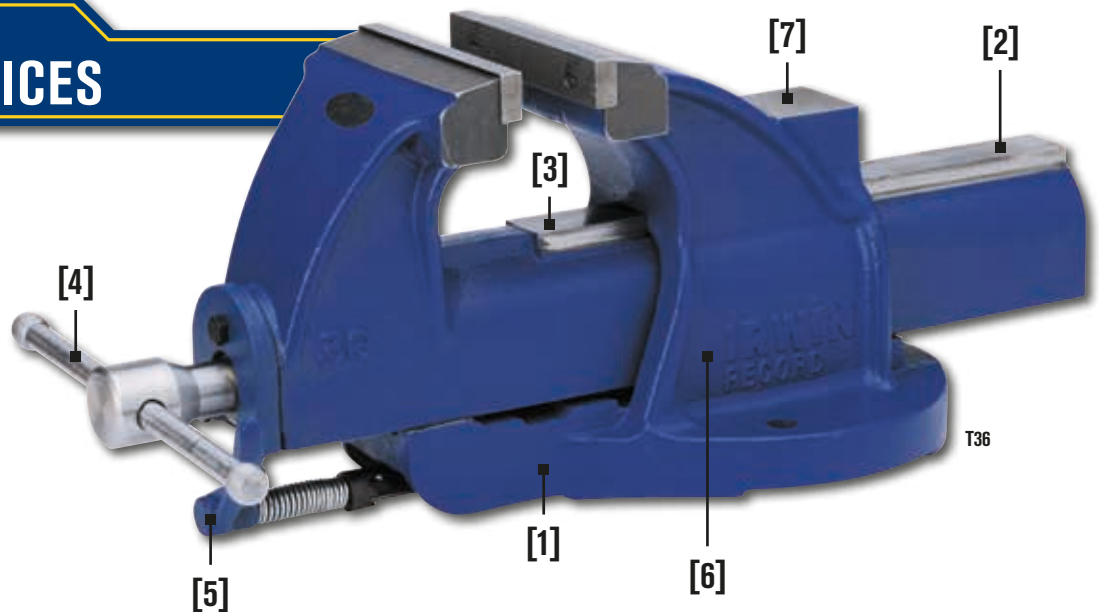

T8434

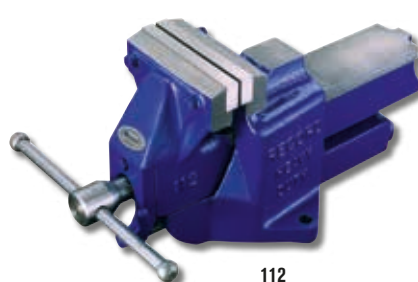

112



T25

SPARE PARTS ALSO AVAILABLE
SEE PAGE 59

Item No.	Description	EAN	Master Pack	Shelf Pack	LP Ex VAT £ / Item	RRP Inc VAT £ / Item	DISC. CODE
T8434	Engineers Vice 4-1/2" / 115mm**	0734442019442	42	1	574.98	689.98	RI
T36	Engineers Vice 6" / 150mm** (Irregular Shape)	0734442019206	18	1	990.17	1188.20	
112	Engineers Vice 6" / 150mm**	0734442019565	22	1	925.03	1110.04	
114ZR	Engineers Vice 8" / 205mm**	0734442019688	22	1	1275.98	1531.18	
23ZR	Fitters Vice 4-1/2" / 115mm	0734442001089	28	1	427.05	512.46	
T25	Fitters Vice 6" / 150mm	0734442001201	22	1	566.15	679.38	

**S.G. Ductile Iron is strong and flexible with similar characteristics to steel and is virtually unbreakable. Heavy duty vices manufactured from this material are designed to take much more punishing workloads than normal vices.

MECHANICS' VICE - HEAVY DUTY RANGE

Rigid and robust, the body and sliding jaw are cast from close grained grey iron which is machined on all friction surfaces for a smooth reliable action. The jaws, handle and main screw are steel, the latter having a two-start rolled acme thread to speed the jaws from fully closed to fully open with a minimum of winding. The most commonly used vice in the IRWIN® range. Full line of replacement parts available.

- Body and sliding jaw** are cast from close grained grey iron which is machined on all friction surfaces for a smooth reliable action
- Safety stop** prevents the slide from being separated from the body
- Replaceable hardened** steel jaws
- Unbreakable SG iron nut** can be replaced when worn
- Fused steel handle** will bend before the vice can be overstressed

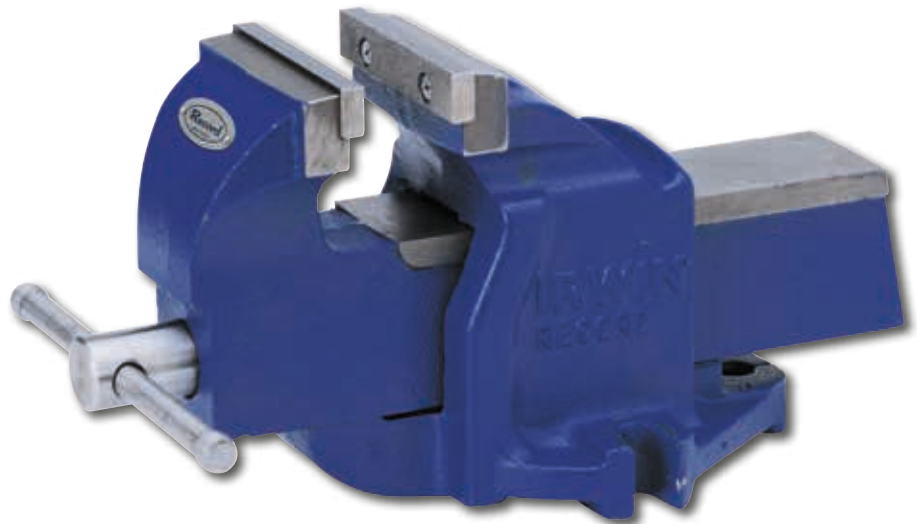

Item No.	Description	EAN	Master Pack	Shelf Pack	LP Ex VAT £ / Item	RRP Inc VAT £ / Item	DISC. CODE
1ZR	No 1, Mechanics' Vice 3" / 75mm	0734442000129	144	1	55.23	66.28	RR
3	No 3, Mechanics' Vice 4" / 100mm	0734442000488	60	1	107.42	128.90	RI
4ZR	No 4, Mechanics' Vice 4-1/2" / 115mm	0734442000501	40	1	188.47	226.16	
5	No 5, Mechanics' Vice 5" / 125mm	0734442000723	40	1	218.30	261.96	
6	No 6, Mechanics' Vice 6" / 150mm	0734442000846	32	1	324.77	389.72	
8ZR	No 8, Mechanics' Vice 8" / 205mm	0734442000969	24	1	579.71	695.65	

WORKSHOP VICES - MEDIUM DUTY

Strong and durable, the body and sliding jaw are cast from close-grained grey iron which is machined on all friction surfaces for a smooth reliable action. The jaws, handle and main screw are steel, the latter having a two-start rolled acme thread to speed the jaws from fully closed to fully open with a minimum of winding. This compact bench vice with anvil is specifically designed for medium-duty workshop applications for both the professional craftsman and the DIY enthusiast who expect a compact vice with superior clamping force, safety features and excellent finish.



Item No.	Description	EAN	Master Pack	Shelf Pack	LP Ex VAT £ / Item	RRP Inc VAT £ / Item	DISC. CODE
10507771	Workshop Vice with Anvil, 3-1/8" / 80mm	5706915077711	1	1	37.68	45.22	IR (HT)
T4121000	Workshop Vice with Anvil, 1 TON, 4" / 100mm	0734442000204	105	1	48.70	58.44	
T3TON3VS	Workshop Vice with Anvil, Swivel Base, 4" / 100mm	0734442000310	60	1	82.65	99.18	
4935505	Workshop Multi-Vice, with Anvil, Swivel Base, 5" / 125mm	0038548989990	40	1	140.55	168.66	
T6TON6VS	Workshop Vice with Anvil, Swivel Base, 6" / 150mm	0734442000860	40	1	175.69	210.83	

QUICK-RELEASE WOODWORKING VICE

Squeeze the trigger and a quick-release vice can be opened and closed without using the mainscrew. Large and small work pieces can be quickly interchanged, while releasing the trigger returns the mechanism to normal for fine adjustment. An ideal addition to the engineering workshop or tool room. For clamping and holding wood work pieces.

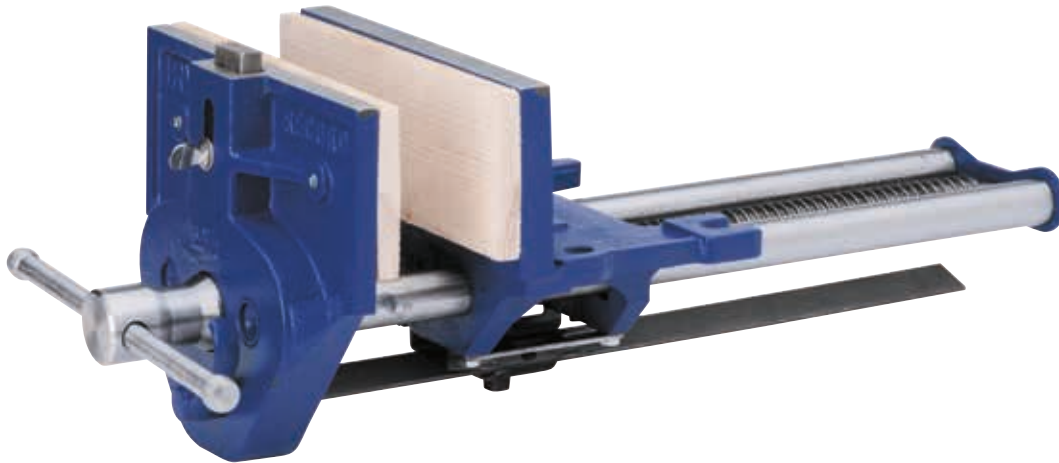

Two steel guide rods to reduce wear and ensure a smooth parallel action

Jaws “toe in” so that when pressure is applied they give an even clamping over the whole depth of the work piece

Adjustable dog used in conjunction with bench stops fitted into the bench top

Location holes are provided so you can fit your own choice of wooden cheeks to protect the work piece

Squeeze the trigger and a quick release vice can be opened and closed without using the mainscrew. Large and small work pieces can be quickly interchanged



PROFESSIONAL QUICK-RELEASE WOODWORKING VICES

Item No.	Description	EAN	Master Pack	Shelf Pack	LP Ex VAT £ / Item	RRP Inc VAT £ / Item	DISC. CODE
T52ED	Woodworking Vice - Quick-Release 7"/175mm	0734442030249	60	1	147.91	177.49	RR
T5212ED	Woodworking Vice - Quick-Release 9"/230mm	0734442030362	32	1	205.44	246.53	
T53ED	Woodworking Vice - Quick-Release 10-1/2"/265mm	0734442030010	24	1	219.14	262.97	

PLAIN SCREW VICES

Manufactured in three capacities, these full size workshop vices are designed for bench mounting. The cast grey iron body and front plate are precision machined to house two solid steel guide rods giving the vice a smooth, true parallel action free of side or cross movement.

Item No.	Description	EAN	Master Pack	Shelf Pack	LP Ex VAT £ / Item	RRP Inc VAT £ / Item	DISC. CODE
T52PD	Woodworking Vice - Plain Screw 7"/175mm	0734442047889	60	1	70.42	84.50	RR
T5212PD	Woodworking Vice - Plain Screw 9"/230mm	0734442047896	32	1	93.33	112.00	
T53PD	Woodworking Vice - Plain Screw 10-1/2"/265mm	0734442030133	24	1	103.65	124.38	

WOODCRAFT VICE

Lightweight vice for the young woodworker, or home handyman. Provides a robust product suitable for the professional who needs a compact vice for smaller work. Designed to be fitted under the work bench, in the normal way, so that the jaws are flush with the bench top. TV150B includes table clamp.

Item No.	Description	EAN	Master Pack	Shelf Pack	LP Ex VAT £ / Item	RRP Inc VAT £ / Item	DISC. CODE
TV149B	Woodcraft Vice 6"/150mm	0734442029656	-	1	28.45	34.14	RR
TV150B	Woodcraft Vice with Table Clamp 6"/150mm	0734442029779	-	1	30.12	36.14	
TV175B	Woodcraft Vice 7"/175mm	0734442029885	-	1	33.45	40.14	

TABLE VICE

This is an ideal portable vice for the amateur and model maker. The built-in clamp allows it to be easily and quickly attached to a bench, table or work surface. Pipe grips are incorporated below the parallel jaws. A useful anvil is also included on the rear of the body. An ideal portable vice for DIY and model making.

Item No.	Description	EAN	Master Pack	Shelf Pack	LP Ex VAT £ / Item	RRP Inc VAT £ / Item	DISC. CODE
TV75B	Table Vice 75mm	0734442001690	-	1	25.65	30.78	RR

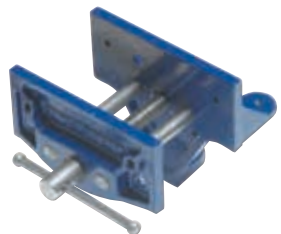

DRILL PRESS VICE

Quality and precision are the hallmarks of these IRWIN® Record® Drill Press Vices, an ideal addition to the engineering workshop or tool room. Designed for use with drill presses and pillar drills.



Item No.	Description	EAN	Master Pack	Shelf Pack	LP Ex VAT £ / Item	RRP Inc VAT £ / Item	DISC. CODE
T414	Drill Press Vice 4" / 100mm	0734442001560	-	1	143.18	171.82	RI

SWIVEL BASES

360 degree swivel bases are used to rotate and lock the vice at the most convenient angle.



Item No.	Description	EAN	Master Pack	Shelf Pack	LP Ex VAT £ / Item	RRP Inc VAT £ / Item	DISC. CODE
T15B	Swivel Base, (No. 1 Vice)	0734442002888	-	1	54.34	65.21	RI
T35B	Swivel Base, (No. 3 Vice)	0734442003007	-	1	85.46	102.55	
T45B	Swivel Base, (No. 4 & 5 Vice)	0734442003120	-	1	85.46	102.55	
T65B	Swivel Base, (No. 6, 8, 25 & 36 Vices)	0734442003366	-	1	120.08	144.10	
T8434235B	Swivel Base, (No. T8434 & 23ZR Vices)	0734442019459	-	1	100.57	120.68	
10507772	Swivel Base, (No. 10507771)	5706915077728	-	1	11.59	13.91	

FIBRE GRIPS

Designed for holding & protecting copper, aluminium, brass and similar soft metals.



Item No.	Description	EAN	Master Pack	Shelf Pack	LP Ex VAT £ / Item	RRP Inc VAT £ / Item	DISC. CODE
FG3	Fibre Grips 3" / 75mm	0734442001928	60	6	11.74	14.09	RI
FG4	Fibre Grips 4" / 100mm	0734442002161	60	6	16.64	19.97	
FG412	Fibre Grips 4-1/2" / 114mm	0734442002406	60	6	17.88	21.46	
FG5	Fibre Grips 5" / 125mm	0734442002529	60	6	19.36	23.23	
FG6	Fibre Grips 6" / 150mm	0734442002765	60	6	21.09	25.31	

CHAIN PIPE VICES

The chain pipe vice generates a powerful grip due to its sturdy construction. The drop-forged, heat-treated steel jaws and high-tensile steel chain are mounted on a body cast from ductile iron that is guaranteed unbreakable. The flexible chain means the vice is compact and easy to store when not in use.



SPARE PARTS ALSO AVAILABLE SEE PAGE 58

Item No.	Description	EAN	Master Pack	Shelf Pack	LP Ex VAT £ / Item	RRP Inc VAT £ / Item	DISC. CODE
T181C	Chain Pipe Vice 1/8" - 2" (3 - 50mm)	0734442143161	-	1	108.89	130.67	RI
T182C	Chain Pipe Vice 1/4" - 4" (6 - 100mm)	0734442143284	-	1	241.38	289.66	
T183C	Chain Pipe Vice 1/2" - 8" (12 - 200mm)	0734442143406	-	1	408.43	490.12	

HINGED PIPE VICES



Item No.	Description	EAN	Master Pack	Shelf Pack	LP Ex VAT £ / Item	RRP Inc VAT £ / Item	DISC. CODE
T92C	Hinged Pipe Vice 1/8" - 2" (3 - 50mm)	0734442143529	-	1	163.62	196.34	RI
T9212C	Hinged Pipe Vice 1/8" - 2-1/2" (3 - 60mm)	0734442143642	-	1	213.78	256.54	
T9312C	Hinged Pipe Vice 1/8" - 3-1/2" (3 - 90mm)	0734442143765	-	1	317.65	381.18	
T96	Hinged Pipe Vice 1/8" - 6" (3 - 150mm)	0734442143888	-	1	763.04	915.65	

TRIPOD STAND

The durable fabricated steel frame, topped by a strong heavy-gauge mounting plate, is drilled to accept our range of chain and hinged pipe vices.



Item No.	Description	EAN	Master Pack	Shelf Pack	LP Ex VAT £ / Item	RRP Inc VAT £ / Item	DISC. CODE
TTS10	Tripod Stand for Hinged Pipe Vice & Chain Pipe Vice (T182C, T92C, T9212C)	0734442142560	-	1	251.40	301.68	RI