

# RS – VULCASCOT Part Reference

RS Part No.	Vulcascot Ref.	Description	Length
392-191	26100311	Snap Fit type Standard black	3m
392-208	26100312	Snap Fit type Standard grey	3m
392-214	26100313	Snap Fit type Standard beige	3m
244-1699	26100321	Snap Fit type Standard black	9m
244-1706	26100322	Snap Fit type Standard grey	9m
244-1728	26100323	Snap Fit type Standard beige	9m
549-915	26100201	Snap Fit type B Black	3m
244-4345	26100328	Snap Fit type B grey	3m
244-1734	26100324	Snap Fit type B black	9m
244-1740	26100325	Snap Fit type B grey	9m
244-1784	26100331	Snap Fit type N Grey	3m
244-1790	26100330	Snap Fit type N black	3m
244-1813	26100327	Snap Fit type D black	3m
244-1756	26100326	Snap Fit type D grey	3m
244-1762	26100333	Snap Fit type C grey	3m
244-1778	26100332	Snap Fit type C black	3m
544-049	26100511	Snap Fit type E black	3m
244-1807	26100329	Snap Fit type E grey	3m
298-3402	26001116	Snap Fit type BNC1 Black	3m
298-3474	26001117	Snap Fit type BNC1 Grey	3m
298-3569	26001118	Snap Fit type BNC1 Black	9m
298-3468	26001119	Snap Fit type BNC1 Grey	9m
298-3418	26001120	Snap Fit type BNC2 black	3m
298-3503	26001121	Snap Fit type BNC2 grey	3m
298-3496	26001122	Snap Fit type BNC2 black	9m
298-3480	26001123	Snap Fit type BNC2 grey	9m
298-3430	26001124	Snap Fit type BNC3 black	4.5m
298-3519	26001125	Snap Fit type BNC3 grey	4.5m
809-194	26100314	Snap Top K grey	9m
080-9201	26100315	Snap Top type L grey	9m
080-9217	26100316	Snap Top type P grey	9m
298-3351	26001115	Snap Top type KB grey	9m
298-3389	26001112	Snap Top type PB grey	9m
298-3395	26001113	Snap Top type PD grey	9m

RS Part No.	Vulcascot Ref.	Description	Length
365-9677	26101115	Warning Profile type HAZ/1	3m
365-9683	26101116	Warning Profile type HAZ/2	3m
365-9706	26101117	Warning Profile type HAZ/1	9m
365-9712	26101118	Warning Profile type HAZ/2	9m
417-9958	26101119	Warning Profile type HAZ/3	3m
417-9964	26101120	Warning Profile type HAZ/3	9m
417-9986	26101121	Warning Profile type HAZ/4	3m
417-9992	26101122	Warning Profile type HAZ/4	9m
418-0009	26101123	Warning Profile type DAN/1	3m
418-0015	26101125	Warning Profile type DAN/2	3m
418-0021	26101127	Warning Profile type DAN/3	3m
418-0037	26101129	Warning Profile type DAN/4	3m
418-0043	26101130	Warning Profile type MAN/1	3m
418-0059	26101132	Warning Profile type MAN/2	3m
418-0065	26101135	Warning Profile type MAN/3	3m
418-0087	26101137	Warning Profile type MAN/4	3m
298-3452	26001128	Ribbon black	3m
298-3525	26001127	Ribbon grey	3m
182-8865	26100317	Industrial Type A black	4.5m
182-8887	26100318	Industrial Type F black	4.5m
182-8893	26100319	Industrial Type FF black	4.5m
182-8900	26100320	Industrial Type FFF black	4.5m
298-3446	26001130	Industrial Type G black	4.5m
298-3553	26001131	Industrial Type G grey	4.5m
707-3358	26101310	Industrial Type H black	4.5m
342-8350	26001134	Temporary Traffic Calmer type TTC/1	4.5m
342-7543	26001136	Temporary Traffic Calmer type TTC/2	4.5m
365-9661	26100340	Temporary Traffic Calmer type TTC/3	1.5m
707-3351	26101312	Temporary Traffic Calmer type TTC/4	1.5m
707-3349	26101320	Heavy Duty (Hinged lid) type HDCP1	1m
541-034	26101111	Quickfit, Black	9m
208-516	26101300	Snap Fit type MCP/1 black	3m
208-522	26101302	Snap Fit type MCP/2 black	4.5m

# VULCASCOT FLEXIBLE CABLE PROTECTORS

Secure loose leads and cables in any environment.

## Snap Fit™ Cable Protectors

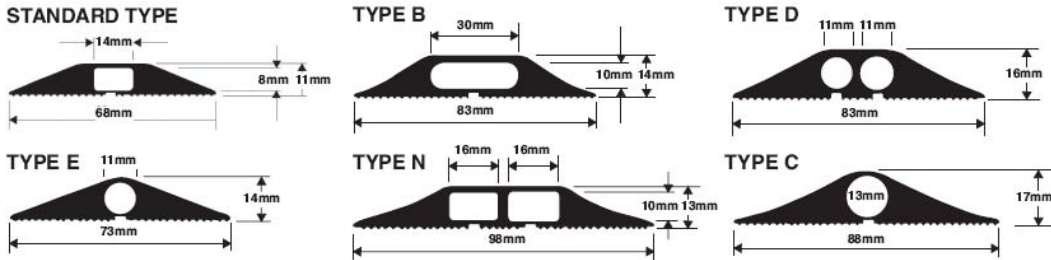

Available in black, grey and beige in 9m lengths

## Multi Compartment Cable Protectors

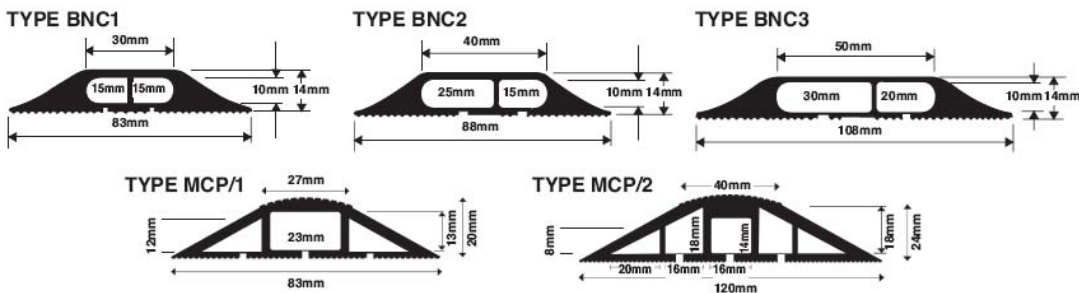

Types BNC1, BNC2 and MCP/1 available in black and grey in 9m lengths

Types BNC3 and MCP/2 available in black and grey in 4.5m lengths

## Hazard Warning™ Cable Protectors

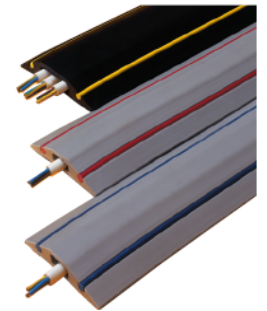
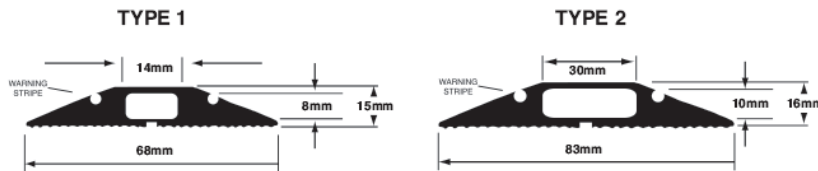

Available in black and grey with high visibility yellow, red or blue stripes in 9m lengths

## Crysclear™ Cable Protectors

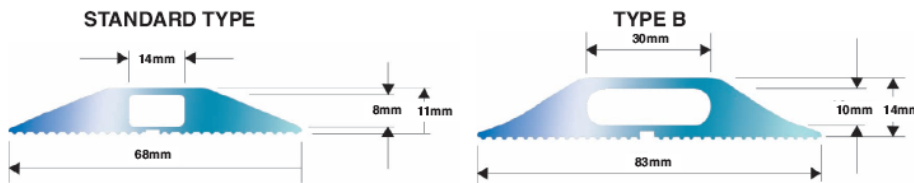

See through cable protectors. Available in 9m lengths



## Snap Top™ Cable Protectors

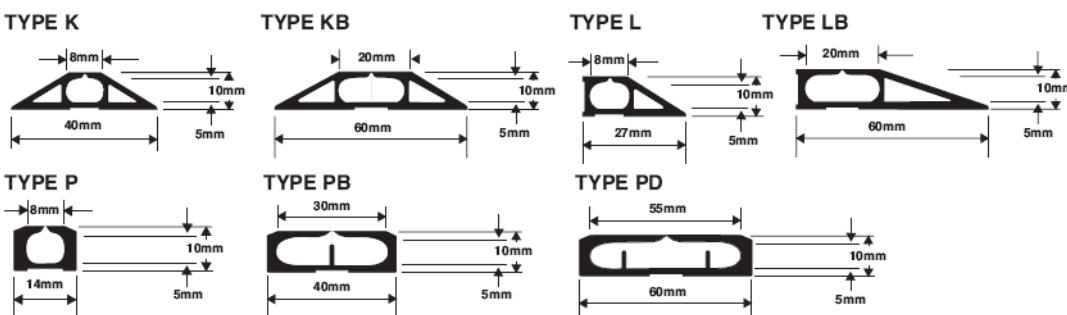

For carrying telephone cables. Available in grey in 9m lengths

# VULCASCOT FLEXIBLE CABLE PROTECTORS

Secure loose leads and cables in any environment

## Industrial Cable Protectors

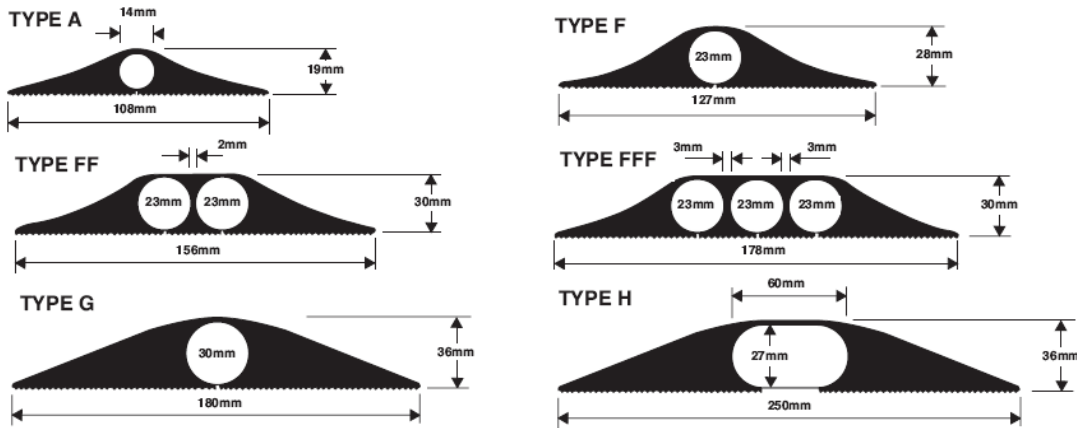

Heavy duty profiles for construction sites, oil rigs, warehouses etc.

Types A & F available in black and grey in 9m lengths

Types FF, FFF and G available in black and grey in 4.5m lengths

Type H available in black and grey in 1.5m lengths

## Temporary Traffic Calming™ Cable Protectors

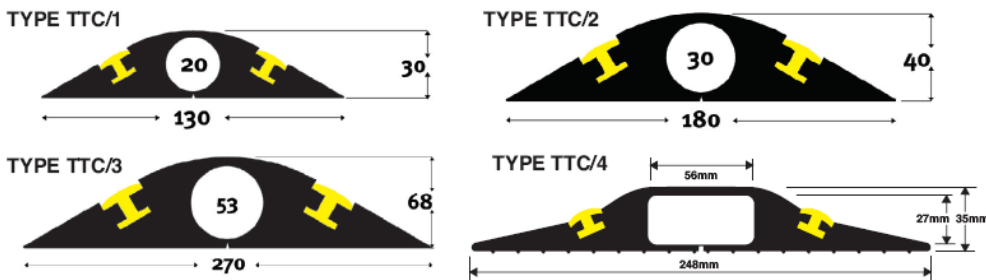

Slow the speed of traffic and protect large diameter cables

Available in black with high visibility yellow stripes

Types TTC/1 and TTC/2 available in 4.5m lengths. Types TTC/3 and TTC/4 available in 1.5m lengths.

## NEW Heavy Duty Cable Protector Type HDCP1



3 x Cable channels 55mm x 65mm  
Available in 1m lengths

Hinged lid allows cables to be inserted after the ramps are in position



All dimensions are for reference only

### Technical Specification

- Produced from FR rated polymers
- Fire retardant to BS476 Part 7 Class 3 and European equivalent DIN 4102 Part 1 and Class B1
- Low smoke, non toxic and low fume emission levels in the event of fire
- Tested for non conductivity to BS903-C5, 500V
- UV stabilised for extended outdoor life

NB This specification does not apply to Crysclear

Snap Fit™, Snap Top™, TTC™, Hazard Warning™ and Crysclear™ are the trade names of Vulcascot Limited



### Vulcascot Limited

Head Office:  
Gatwick Gate Estate  
Lowfield Heath, Crawley  
West Sussex RH11 0TG  
Tel: 01293 560130  
Fax: 01293 537743  
E-mail: info@vulcascot.co.uk  
Web site: www.vulcascot.com