

# Thyristor Module

$$V_{RRM} = 2 \times 1600V$$

$$I_{TAV} = 140A$$

$$V_T = 1.28V$$

Phase leg

Part number

**MCMA140P1600TA**

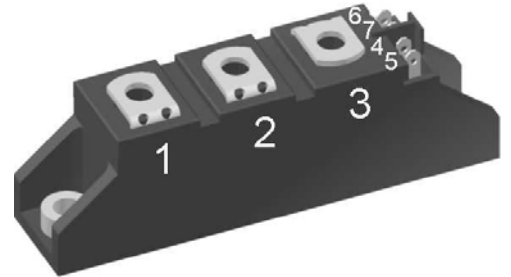

Backside: isolated



**Features / Advantages:**

- Thyristor for line frequency
- Planar passivated chip
- Long-term stability
- Direct Copper Bonded Al<sub>2</sub>O<sub>3</sub>-ceramic

**Applications:**

- Line rectifying 50/60 Hz
- Softstart AC motor control
- DC Motor control
- Power converter
- AC power control
- Lighting and temperature control

**Package: TO-240AA**

- Isolation Voltage: 4800 V~
- Industry standard outline
- RoHS compliant
- Soldering pins for PCB mounting
- Base plate: DCB ceramic
- Reduced weight
- Advanced power cycling

Thyristor			Ratings				
Symbol	Definition	Conditions	min.	typ.	max.	Unit	
$V_{RSM/DSM}$	max. non-repetitive reverse/forward blocking voltage	$T_{VJ} = 25^{\circ}C$			1700	V	
$V_{RRM/DRM}$	max. repetitive reverse/forward blocking voltage	$T_{VJ} = 25^{\circ}C$			1600	V	
$I_{RD}$	reverse current, drain current	$V_{RD} = 1600 V$	$T_{VJ} = 25^{\circ}C$		100	$\mu A$	
		$V_{RD} = 1600 V$	$T_{VJ} = 140^{\circ}C$		10	mA	
$V_T$	forward voltage drop	$I_T = 150 A$	$T_{VJ} = 25^{\circ}C$		1.29	V	
					1.63	V	
		$I_T = 300 A$	$T_{VJ} = 125^{\circ}C$		1.28	V	
					1.70	V	
$I_{TAV}$	average forward current	$T_C = 85^{\circ}C$	$T_{VJ} = 140^{\circ}C$		140	A	
$I_{T(RMS)}$	RMS forward current	180° sine			220	A	
$V_{T0}$	threshold voltage	} for power loss calculation only	$T_{VJ} = 140^{\circ}C$		0.85	V	
$r_T$	slope resistance				2.8	m $\Omega$	
$R_{thJC}$	thermal resistance junction to case				0.22	K/W	
$R_{thCH}$	thermal resistance case to heatsink		0.20			K/W	
$P_{tot}$	total power dissipation		$T_C = 25^{\circ}C$		520	W	
$I_{TSM}$	max. forward surge current	t = 10 ms; (50 Hz), sine	$T_{VJ} = 45^{\circ}C$	$V_R = 0 V$	2.40	kA	
					t = 8,3 ms; (60 Hz), sine	2.59	kA
		t = 10 ms; (50 Hz), sine	$T_{VJ} = 140^{\circ}C$	$V_R = 0 V$	2.04	kA	
					t = 8,3 ms; (60 Hz), sine	2.21	kA
$I^2t$	value for fusing	t = 10 ms; (50 Hz), sine	$T_{VJ} = 45^{\circ}C$	$V_R = 0 V$	28.8	kA <sup>2</sup> s	
					t = 8,3 ms; (60 Hz), sine	27.9	kA <sup>2</sup> s
		t = 10 ms; (50 Hz), sine	$T_{VJ} = 140^{\circ}C$	$V_R = 0 V$	20.8	kA <sup>2</sup> s	
					t = 8,3 ms; (60 Hz), sine	20.2	kA <sup>2</sup> s
$C_J$	junction capacitance	$V_R = 400 V$ f = 1 MHz	$T_{VJ} = 25^{\circ}C$	119		pF	
$P_{GM}$	max. gate power dissipation	$t_p = 30 \mu s$	$T_C = 140^{\circ}C$		10	W	
		$t_p = 300 \mu s$			5	W	
$P_{GAV}$	average gate power dissipation				0.5	W	
$(di/dt)_{cr}$	critical rate of rise of current	$T_{VJ} = 140^{\circ}C$ ; f = 50 Hz	repetitive, $I_T = 450 A$		150	A/ $\mu s$	
				$t_p = 200 \mu s$ ; $di_G/dt = 0.45 A/\mu s$ ;			
$(dv/dt)_{cr}$	critical rate of rise of voltage	$V_D = \frac{2}{3} V_{DRM}$	$T_{VJ} = 140^{\circ}C$	$I_G = 0.45 A$ ; $V_D = \frac{2}{3} V_{DRM}$	non-repet., $I_T = 150 A$	500	A/ $\mu s$
						$R_{GK} = \infty$ ; method 1 (linear voltage rise)	
$V_{GT}$	gate trigger voltage	$V_D = 6 V$	$T_{VJ} = 25^{\circ}C$		1.5	V	
			$T_{VJ} = -40^{\circ}C$		1.6	V	
$I_{GT}$	gate trigger current	$V_D = 6 V$	$T_{VJ} = 25^{\circ}C$		150	mA	
			$T_{VJ} = -40^{\circ}C$		200	mA	
$V_{GD}$	gate non-trigger voltage	$V_D = \frac{2}{3} V_{DRM}$	$T_{VJ} = 140^{\circ}C$		0.2	V	
$I_{GD}$	gate non-trigger current				10	mA	
$I_L$	latching current	$t_p = 10 \mu s$	$T_{VJ} = 25^{\circ}C$	$I_G = 0.45 A$ ; $di_G/dt = 0.45 A/\mu s$	200	mA	
$I_H$	holding current	$V_D = 6 V$ $R_{GK} = \infty$	$T_{VJ} = 25^{\circ}C$		200	mA	
$t_{gd}$	gate controlled delay time	$V_D = \frac{1}{2} V_{DRM}$	$T_{VJ} = 25^{\circ}C$	$I_G = 0.45 A$ ; $di_G/dt = 0.45 A/\mu s$	2	$\mu s$	
$t_q$	turn-off time	$V_R = 100 V$ ; $I_T = 150 A$ ; $V_D = \frac{2}{3} V_{DRM}$	$T_{VJ} = 140^{\circ}C$	185		$\mu s$	
		$di/dt = 10 A/\mu s$ ; $dv/dt = 20 V/\mu s$ ; $t_p = 200 \mu s$					

Package TO-240AA		Ratings				
Symbol	Definition	Conditions	min.	typ.	max.	Unit
$I_{RMS}$	RMS current	per terminal			200	A
$T_{VJ}$	virtual junction temperature		-40		140	°C
$T_{op}$	operation temperature		-40		125	°C
$T_{stg}$	storage temperature		-40		125	°C
<b>Weight</b>				90		g
$M_D$	mounting torque		2.5		4	Nm
$M_T$	terminal torque		2.5		4	Nm
$d_{Sppl/App}$	creepage distance on surface   striking distance through air	terminal to terminal	13.0	9.7		mm
$d_{Spb/Apb}$		terminal to backside	16.0	16.0		mm
$V_{ISOL}$	isolation voltage	t = 1 second	50/60 Hz, RMS; $I_{ISOL} \leq 1$ mA		4800	V
		t = 1 minute			4000	V

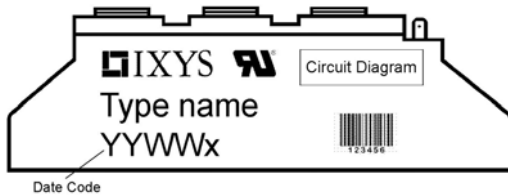
**Part number**

- M = Module
- C = Thyristor (SCR)
- M = Thyristor
- A = (up to 1800V)
- 140 = Current Rating [A]
- P = Phase leg
- 1600 = Reverse Voltage [V]
- TA = TO-240AA-1B

Ordering	Part Number	Marking on Product	Delivery Mode	Quantity	Code No.
Standard	MCMA140P1600TA	MCMA140P1600TA	Box	6	509341

Similar Part	Package	Voltage class
MCMA140P1800TA	TO-240AA-1B	1800

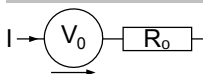
**Equivalent Circuits for Simulation**
*\* on die level*
 $T_{VJ} = 140\text{ °C}$ 

**Thyristor**

$V_{0\ max}$	threshold voltage	0.85	V
$R_{0\ max}$	slope resistance *	1.6	mΩ

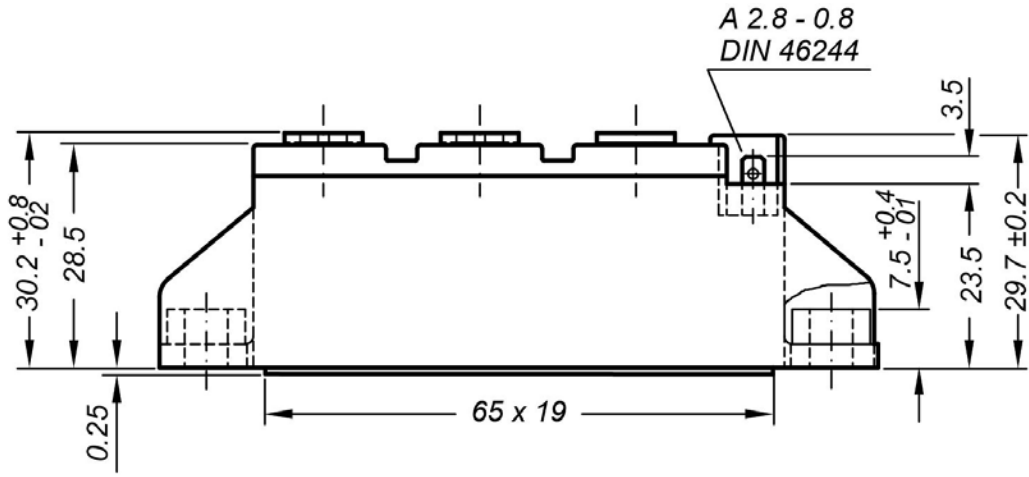
**Outlines TO-240AA**

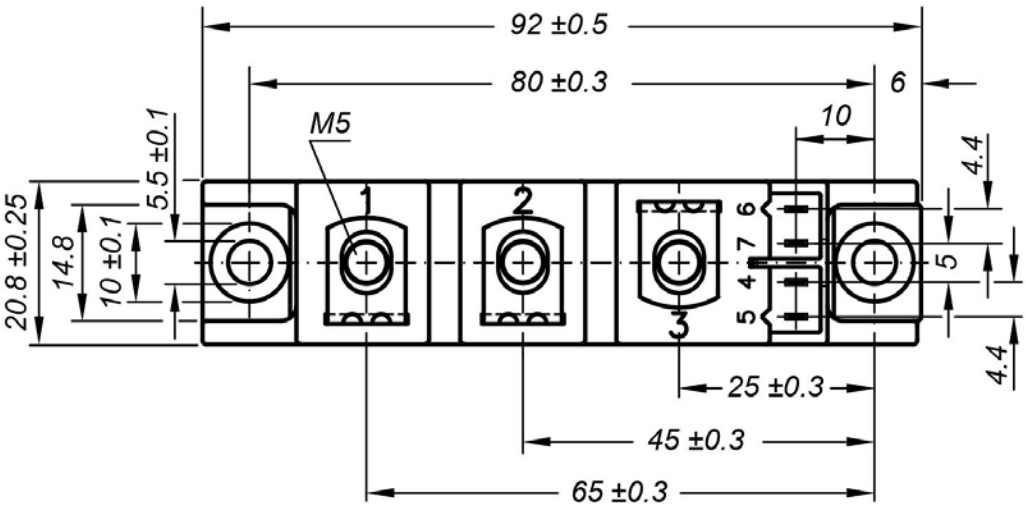

General tolerance: DIN ISO 2768 class „c“



Optional accessories: Keyed gate/cathode twin plugs  
 Wire length: 350 mm, gate = white, cathode = red  
 UL 758, style 3751  
 Type **ZY 200L** (L = Left for pin pair 4/5)  
 Type **ZY 200R** (R = Right for pin pair 6/7)

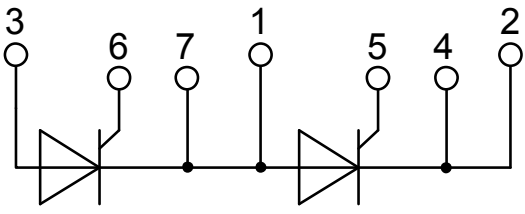

## Thyristor

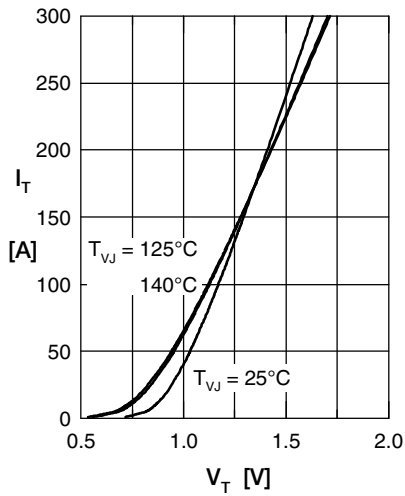

Fig. 1 Forward characteristics

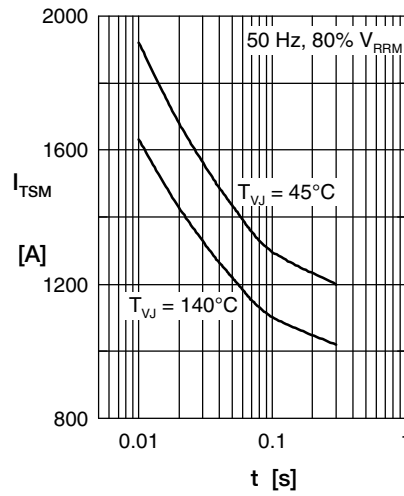

Fig. 2 Surge overload current  
 $I_{TSM}$ : crest value, t: duration

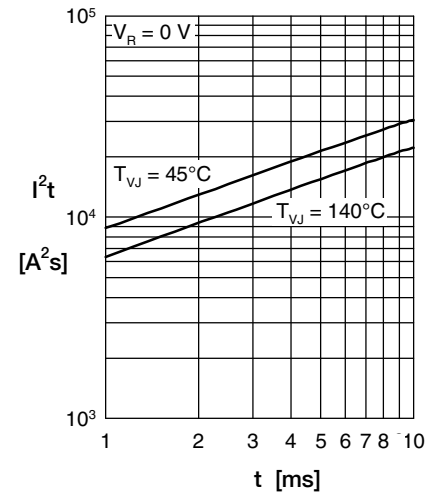

Fig. 3  $I^2t$  versus time (1-10 s)

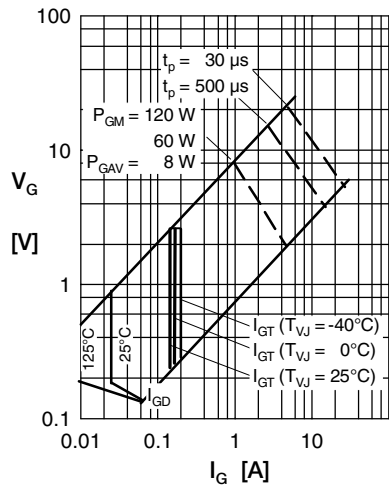

Fig. 4 Gate voltage & gate current

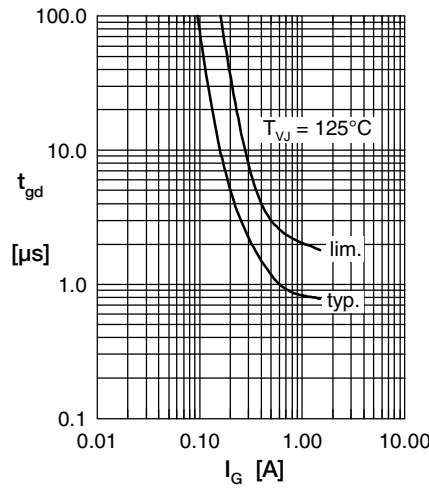

Fig. 5 Gate controlled delay time  $t_{gd}$

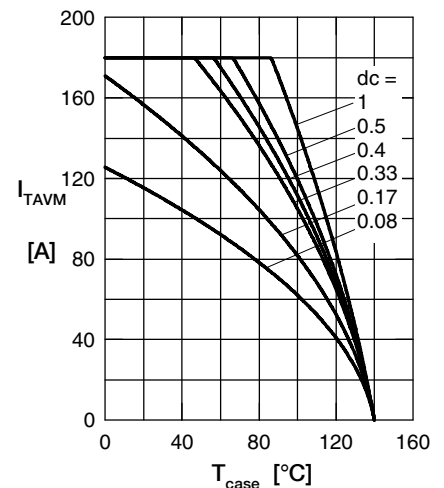

Fig. 6 Max. forward current at case temperature

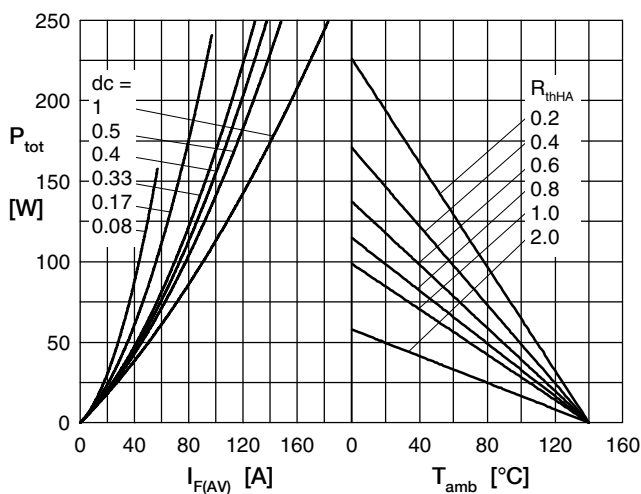

Fig. 7a Power dissipation versus direct output current  
Fig. 7b and ambient temperature

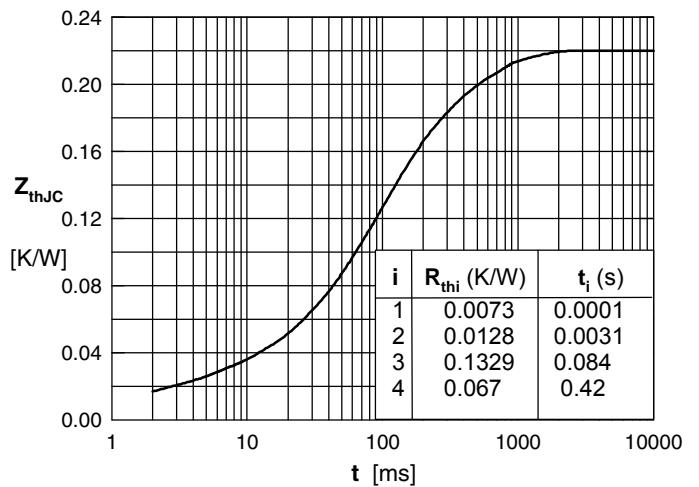

Fig. 8 Transient thermal impedance junction to case