

Photomicrosensor (Transmissive) EE-SV3 Series

⚠ Be sure to read *Precautions* on page 25.

■ Dimensions

Note: All units are in millimeters unless otherwise indicated.

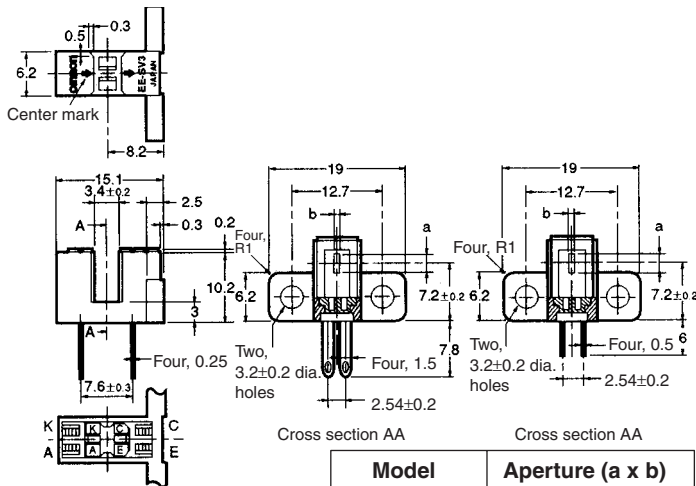

Model	Aperture (a x b)
EE-SV3(-B)	2.1 x 0.5
EE-SV3-C(S)	2.1 x 1.0
EE-SV3-D(S)	2.1 x 0.2
EE-SV3-G(S)	0.5 x 2.1

Internal Circuit

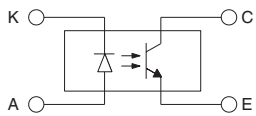

Unless otherwise specified, the tolerances are as shown below.

Dimensions	Tolerance
3 mm max.	±0.2
3 < mm ≤ 6	±0.24
6 < mm ≤ 10	±0.29
10 < mm ≤ 18	±0.35
18 < mm ≤ 30	±0.42

Terminal No.	Name
A	Anode
K	Cathode
C	Collector
E	Emitter

■ Features

- High-resolution model with a 0.2-mm-wide or 0.5-mm-wide sensing aperture, high-sensitivity model with a 1-mm-wide sensing aperture, and model with a horizontal sensing aperture are available.
- Solder terminal models:
EE-SV3/-SV3-CS/-SV3-DS/-SV3-GS
- PCB terminal models
EE-SV3-B/-SV3-C/-SV3-D/-SV3-G

■ Absolute Maximum Ratings (Ta = 25°C)

Item	Symbol	Rated value
Emitter	Forward current	I_F 50 mA (see note 1)
	Pulse forward current	I_{FP} 1 A (see note 2)
	Reverse voltage	V_R 4 V
Detector	Collector-Emitter voltage	V_{CEO} 30 V
	Emitter-Collector voltage	V_{ECO} ---
	Collector current	I_C 20 mA
	Collector dissipation	P_C 100 mW (see note 1)
Ambient temperature	Operating	T_{opr} -25°C to 85°C
	Storage	T_{stg} -30°C to 100°C
Soldering temperature	T_{sol}	260°C (see note 3)

- Note:**
1. Refer to the temperature rating chart if the ambient temperature exceeds 25°C.
 2. The pulse width is 10 μ s maximum with a frequency of 100 Hz.
 3. Complete soldering within 10 seconds.

■ Electrical and Optical Characteristics (Ta = 25°C)

Item	Symbol	Value				Condition	
		EE-SV3(-B)	EE-SV3-C(S)	EE-SV3-D(S)	EE-SV3-G(S)		
Emitter	Forward voltage	V_F	1.2 V typ., 1.5 V max.			$I_F = 30$ mA	
	Reverse current	I_R	0.01 μ A typ., 10 μ A max.			$V_R = 4$ V	
	Peak emission wavelength	λ_p	940 nm typ.			$I_F = 20$ mA	
Detector	Light current	I_L	0.5 to 14 mA	1 to 28 mA	0.1 mA min.	0.5 to 14 mA	$I_F = 20$ mA, $V_{CE} = 10$ V
	Dark current	I_D	2 nA typ., 200 nA max.			$V_{CE} = 10$ V, 0 lx	
	Leakage current	I_{LEAK}	---			---	
	Collector-Emitter saturated voltage	$V_{CE(sat)}$	0.1 V typ., 0.4 V max.		---	0.1 V typ., 0.4 V max.	$I_F = 20$ mA, $I_L = 0.1$ mA
	Peak spectral sensitivity wavelength	λ_p	850 nm typ.			$V_{CE} = 10$ V	
Rising time	t_r	4 μ s typ.			$V_{CC} = 5$ V, $R_L = 100$ Ω , $I_L = 5$ mA		
Falling time	t_f	4 μ s typ.					

■ Engineering Data

Forward Current vs. Collector Dissipation Temperature Rating

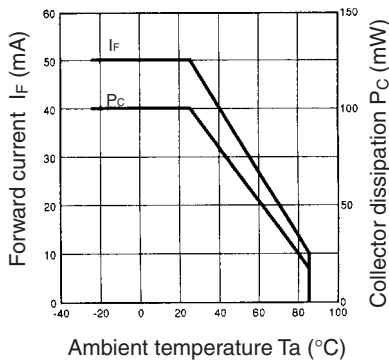

Forward Current vs. Forward Voltage Characteristics (Typical)

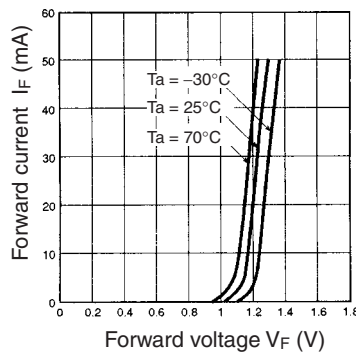

Light Current vs. Forward Current Characteristics (Typical)

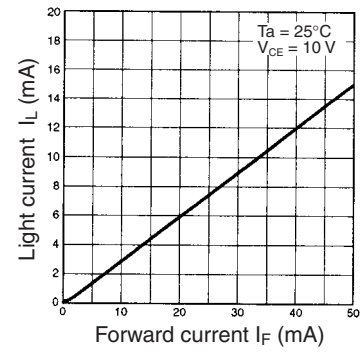

Light Current vs. Collector-Emitter Voltage Characteristics (EE-SV3(-B))

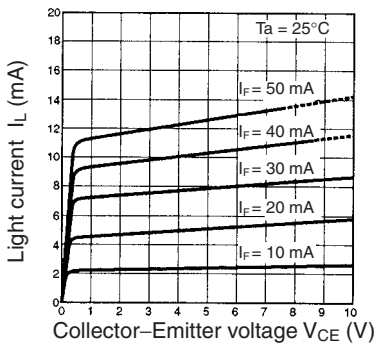

Relative Light Current vs. Ambient Temperature Characteristics (Typical)

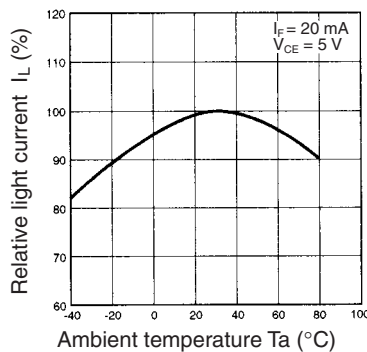

Dark Current vs. Ambient Temperature Characteristics (Typical)

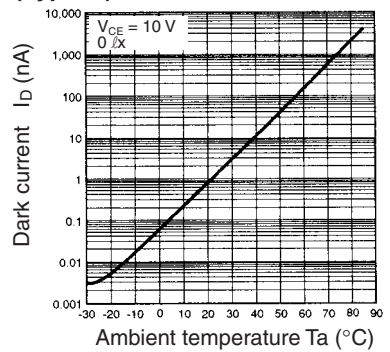

Response Time vs. Load Resistance Characteristics (Typical)

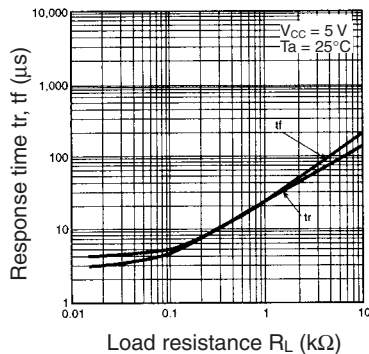

Sensing Position Characteristics (EE-SV3-D(S))

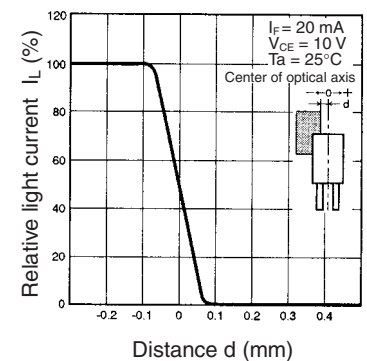

Sensing Position Characteristics (EE-SV3(-B))

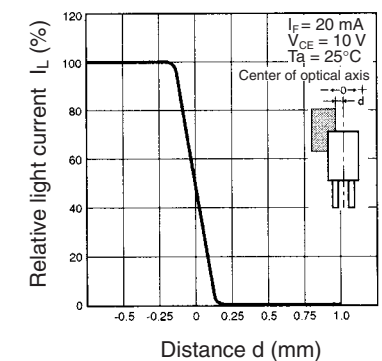

Sensing Position Characteristics (EE-SV3-G(S))

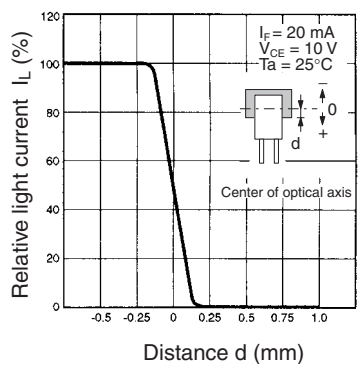

Sensing Position Characteristics (EE-SV3-C(S))

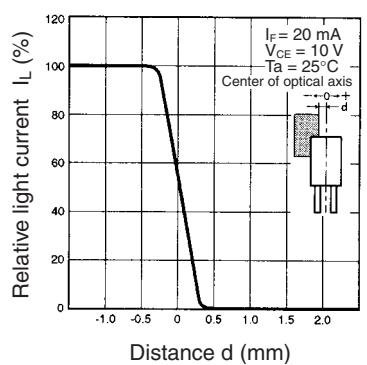

Response Time Measurement Circuit

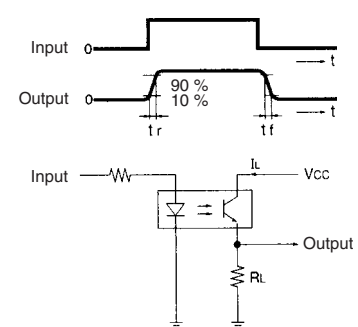

Mouser Electronics

Authorized Distributor

Click to View Pricing, Inventory, Delivery & Lifecycle Information:

Omron:

[EE-SV3-B](#) [EE-SV3](#) [EE-SV3-C](#) [EE-SV3-CS](#) [EE-SV3-D](#) [EE-SV3-G](#) [EE-SV3-GS](#) [EE-SV3-DS](#)