

RSS Series Panel Mount Solid State Relays

Key features:

- Input status LED Indicator
- Dual SCR output with epoxy free design
- Direct bond copper substrate with direct output lead frame termination
- Internal transient protection – built-in snubber
- EMC compliant (level 3)
- 1200 Volt blocking voltage
- 4000 Volt optical isolation
- Zero crossing voltage turn-on
- High surge capability
- Optional fingersafe cover (RSS-CVR)



UL Recognized
File No. E194577



Part Number Selection

Input	Continuous Output Current	Part Number
AC Input 90-280V AC	10A	RSSAN-10A
	25A	RSSAN-25A
	50A	RSSAN-50A
	75A	RSSAN-75A
	90A	RSSAN-90A
DC Input 3-32V DC	10A	RSSDN-10A
	25A	RSSDN-25A
	50A	RSSDN-50A
	75A	RSSDN-75A
	90A	RSSDN-90A

Wiring Diagram

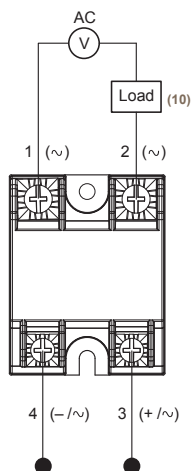

Specifications

	Series	RSSDN		RSSAN		
Input Specifications	Voltage Range	3 to 32V DC		90 to 280V AC		
	Input Current	current regulated (10mA)				
	Pick Up Voltage	3V DC		90V AC		
	Drop Out Voltage	1V DC		10V AC		
	Dielectric Strength (Input-Output-Base)	4000 RMS (min)		4000 RMS (min)		
	Capacitance (Input to Output)	8pF		8pF		
	Rev. Voltage Protection	Yes (-32V DC)		N/A		
	Output Specifications	Current (continuous)	10A	25A	50A	75A
1-Cycle Surge Current		150A	300A	750A	1000A	1200A
1-Second Surge Current at 25°C		50A	85A	150A	225A	300A
Minimum Holding Current		50mA	50mA	100mA	100mA	100mA
Voltage Drop at Rated Current		1.35V (maximum)				
Voltage Range		48 - 660V AC				
Output		Dual SCR (N.O.)				
Over Voltage Rating		1200 PIV				
Frequency Range		47 to 440Hz				
Off-State Leakage at Rated Voltage		25mA (maximum)				
Turn-On Time		1/2 cycle @ 60Hz for zero-cross versions, 20ms for other versions				
Turn-Off Time		1/2 cycle @ 60Hz for zero-cross versions, 30ms for other versions				
Zero Voltage Switching		Yes				
Static DV/DT		200V/µsec				
Commutating DV/DT		Snubbed for 0.5 power factor at rated load				
Ambient operating temperature range	-20 to 80°C					
Weight	82g					

Switches & Pilot Lights

Signaling Lights

Relays & Sockets

Timers

Contactors

Terminal Blocks

Circuit Breakers

Recommended Loads

Transformer Loads

Transformer loads sometimes result in severe inrush current when the transformer saturates during the first cycle. Use a relay rated for this surge, which has a 1/2 cycle surge current greater than the maximum applied line voltage; the transformer's primary resistance (approximately 10x rated current).

Recommended Loads

SSR Rating	at 120V AC	at 240V AC
10A	500VA	1KVA
25A	1KVA	2KVA
50A	2KVA	4KVA

Heater Loads

When using solid state relays for driving heaters where the load is switched on and off rapidly and continuously, severe thermal stress will result. In such cases, use an SSR relay at no more than 75% of the rating.

Recommended Loads

SSR Rating	at 120V AC	at 240V AC
10A	1KW	2KW
25A	2KW	4KW
50A	3KW	6KW

Solenoid Valves and Contactors

RSS relays use high-noise immunity circuitry with a built-in snubber to handle the electrical noise generated by inductive loads.

Recommended Loads

SSR Rating	at 120V AC	at 240V AC
10A	900W	1,800W
25A	2,100W	4,200W
50A	3,800W	7,500W

RSS series relays provide a highly reliable means of switching AC loads when applied properly. Read the technical notes on the following page prior to installing solid state relays.

UL Motor Load Ratings (HP Ratings)

Part Number	120V	240V	480V
10A	1/2	3/4	3/4
25A	1/2	3/4	3/4
50A	3/4	1 1/2	1 1/2
75A	3/4	5	5
90A	3/4	5	5

Lamp Loads

Zero voltage switching is ideal for driving incandescent lamps, since the cold filament will not be subjected to a large inrush current. Using a zero-switched SSR will reduce inrush current and prolong lamp life.

Recommended Loads

SSR Rating	at 120V AC	at 240V AC
10A	1KW	2KW
25A	2KW	4KW
50A	3KW	6KW

Recommended Wire Sizes

Terminals	Wire Size (Solid/Stranded)	Wire Pull-Out Strength (lbs) (N)
Input	24 AWG (0.2 mm ²) / 0.2 (min)	10 (44.5)
	2 x 12 AWG (3.3 mm ²) / 3.3 (max)	90 (400)
Output	20 AWG (0.5 mm ²) / 0.518 (min)	3 (133)
	2 x 10 AWG (5.4 mm ²) / 5.4	110 (490)
	2 x 8 AWG (8.4 mm ²) / 8.4 (max)	90 (400)

Internal Circuit Block Diagram

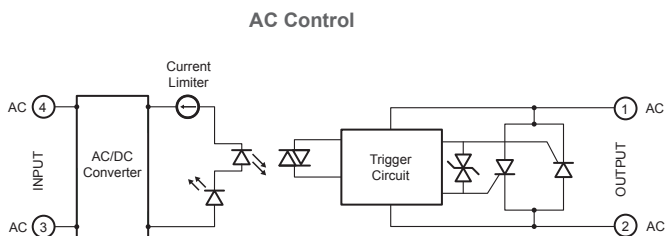
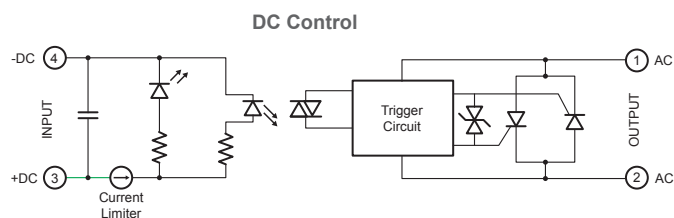

Technical Notes

Environment

Do not install SSRs near sources of excessive heat. Make sure applications are dry and well ventilated.

If SSRs must be installed in an environment subject to high temperatures or poor ventilation, or if SSRs are mounted collectively, reduce the load current so that it does **not** approach the ambient temperature-load current recommendation. (See the Temperature Derating Curves on the following page.)

When SSRs are used with inductive loads, suppress the inrush current to half of the peak surge current.

Heat Sinks

Heat sinks are recommended for all solid state relays depending on ambient temperature and mounting position. The recommended heat sink dimensions and material are shown in the table:

Output Rating	Dimensions	Material
10A	12" x 12" x 1/8"	Aluminum (black anodized)
25A	12" x 12" x 1/8" (DC/AC)	Aluminum (black anodized)
25A	15" x 15" x 1/8" (AC/AC)	Aluminum (black anodized)
50A	15" x 15" x 1/8"	Aluminum (black anodized)
75A	17" x 17" x 1/8"	Aluminum (black anodized)
90A	17" x 17" x 1/8"	Aluminum (black anodized)

Using a thermal compound between the base of the SSR and the heat sink for heat dissipation is recommended.

Wiring

Locate SSRs as far from motor leads as possible to prevent malfunction from induced current.

Use shielded wires for input leads when they are exposed to a source of induced current.

Mounting

Provide sufficient ventilation.

Use #6 – 32 screws, flat washers, and lock washers to secure mounting on heat sinks.

Vertical mounting is recommended to allow air to flow unimpeded. Horizontal or inverted mounting is possible, but the SSR must be derated according to the derating curves on the following page.

Additional Information

Do not exceed the load voltage and current specifications.

A small-capacity load may not turn off due to the leakage current present after the SSR has turned off. If this is the case, use a resistor in parallel with the load to shunt the leakage current.

Observe the polarity of input terminals. Failure to do so may cause damage to the SSR.

When the SSR output is subjected to a higher than rated voltage, a varistor or other element should be connected to the output terminals to absorb the over-voltage.

When the input signal contains a ripple voltage, the lowest ripple amplitude should exceed the minimum pick-up voltage of 4V.

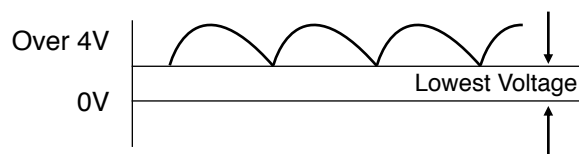

Temperature Derating Curves: RSS Series - Dependent upon heat-sink heat dissipation

10 AMP SCR OUTPUT

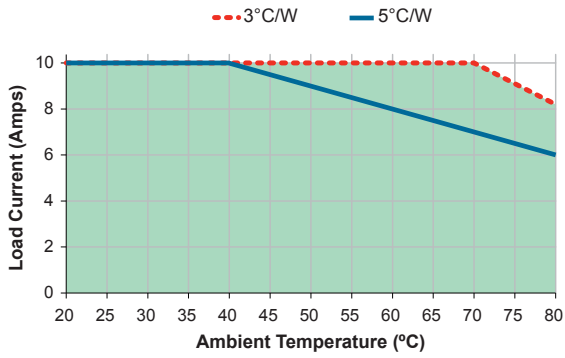

25 AMP SCR OUTPUT

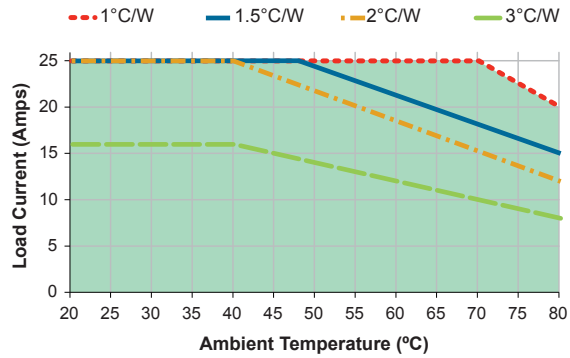

50 AMP SCR OUTPUT

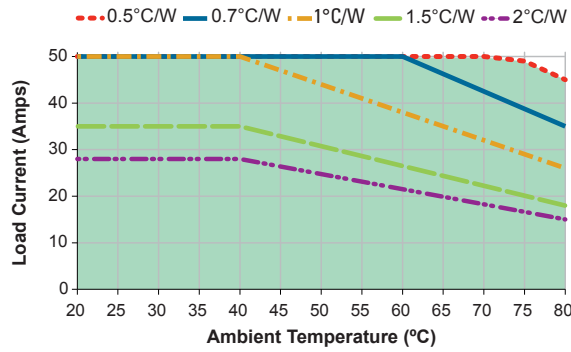

75 AMP SCR OUTPUT

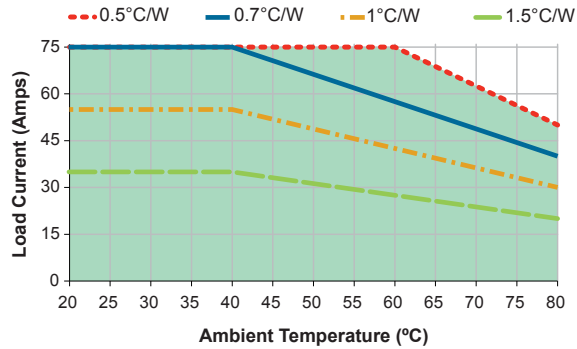

90 AMP SCR OUTPUT

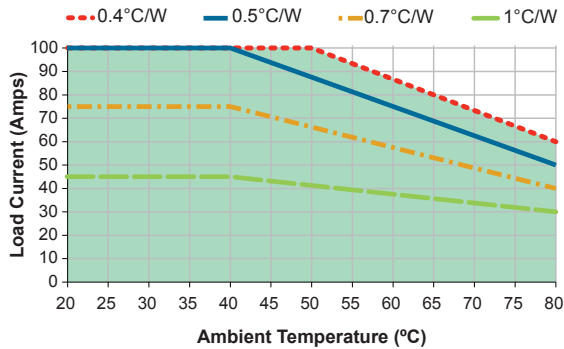

Switches & Pilot Lights

Signaling Lights

Relays & Sockets

Timers

Contactors

Terminal Blocks

Circuit Breakers

Dimensions (mm)

Relay Dimensions

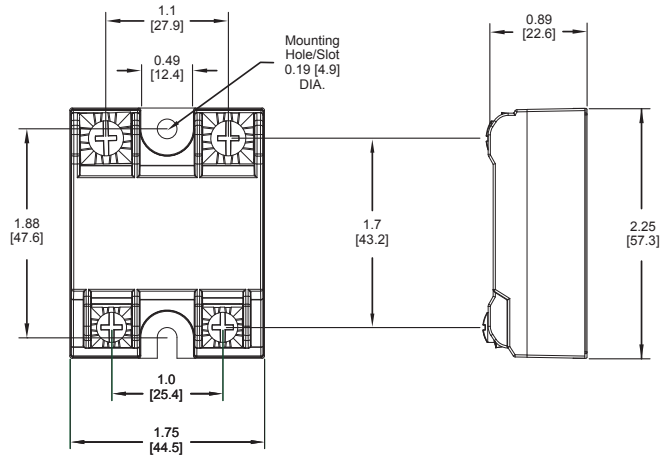

Finger-safe Cover Dimensions

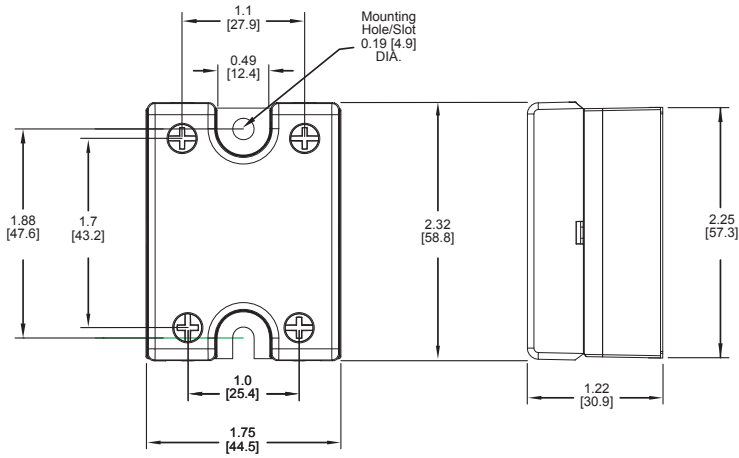

Tolerances: ±0.02 in / 0.5 mm
 All dimensions are in: inches [millimeters]

Mouser Electronics

Authorized Distributor

Click to View Pricing, Inventory, Delivery & Lifecycle Information:

IDEC:

[RSS-CVR](#) [RSSDN-50A](#) [RSSAN-75A](#) [RSSAN-10A](#) [RSSAN-25A](#) [RSSDN-25A](#) [RSSDN-75A](#) [RSSDN-90A](#) [RSSAN-90A](#) [RSSDN-10A](#) [RSSAN-50A](#) [RSSDN-25A GEN3](#) [RSSAN-25A GEN3](#) [RSSA-10A](#) [RSSA-40A](#) [RSSD-25A](#) [RSSA-25A](#) [RSSD-10A](#)