

Single Thyristor Module

$I_{TRMS} = 85 \text{ A}$
 $V_{RRM} = 1200-1600 \text{ V}$
 $I_{TAV} = 54 \text{ A}$

Preliminary data

V_{RSM} V_{DSM} V	V_{RRM} V_{DRM} V	Type
1200	1200	MCO 50-12io1
1600	1600	MCO 50-16io1

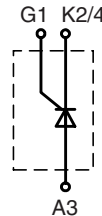

miniBLOC, SOT-227 B

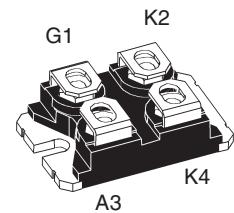

Symbol	Conditions	Maximum Ratings	
I_{TRMS}	$T_{VJ} = T_{VJM}$	85	A
I_{TAV}	$T_C = 80^\circ\text{C}; (180^\circ \text{ sine})$	54	A
I_{TSM}	$T_{VJ} = 45^\circ\text{C};$ $V_R = 0$	$t = 10 \text{ ms (50 Hz), sine}$	740 A
		$t = 8.3 \text{ ms (60 Hz), sine}$	800 A
	$T_{VJ} = T_{VJM}$ $V_R = 0$	$t = 10 \text{ ms (50 Hz), sine}$	650 A
		$t = 8.3 \text{ ms (60 Hz), sine}$	700 A
I^2t	$T_{VJ} = 45^\circ\text{C}$ $V_R = 0$	$t = 10 \text{ ms (50 Hz), sine}$	2740 A ² s
		$t = 8.3 \text{ ms (60 Hz), sine}$	2700 A ² s
	$T_{VJ} = T_{VJM}$ $V_R = 0$	$t = 10 \text{ ms (50 Hz), sine}$	2100 A ² s
		$t = 8.3 \text{ ms (60 Hz), sine}$	2100 A ² s
$(di/dt)_{cr}$	$T_{VJ} = T_{VJM}$ $f = 50 \text{ Hz}, t_p = 200 \mu\text{s}$ $V_D = \frac{2}{3} V_{DRM}$ $I_G = 0.3 \text{ A}$ $di_G/dt = 0.3 \text{ A}/\mu\text{s}$	repetitive, $I_T = 150 \text{ A}$	100 A/ μs
		non repetitive, $I_T = I_{TAVM}$	500 A/ μs
$(dv/dt)_{cr}$	$T_{VJ} = T_{VJM};$ $R_{GK} = \infty;$ method 1 (linear voltage rise)	$V_{DR} = \frac{2}{3} V_{DRM}$	1000 V/ μs
P_{GM}	$T_{VJ} = T_{VJM}$ $I_T = I_{TAVM}$	$t_p = 30 \mu\text{s}$	10 W
		$t_p = 300 \mu\text{s}$	5 W
P_{GAVM}			0.5 W
V_{RGM}			10 V
T_{VJ}		-40...+150	$^\circ\text{C}$
T_{VJM}		150	$^\circ\text{C}$
T_{stg}		-40...+150	$^\circ\text{C}$
V_{ISOL}	50/60 Hz, RMS; $I_{ISOL} \leq 1 \text{ mA}$	2500	V~
M_d	Mounting torque (M4)	1.1 - 1.5 / 9 - 13	Nm/lb.in.
	Terminal connection torque (M4)	1.1 - 1.5 / 9 - 13	Nm/lb.in.
Weight	typ.	30	g

Features

- International standard package miniBLOC (ISOTOP compatible)
- Isolation voltage 2500 V~
- Planar passivated chips

Applications

- Solid state switches
- motor control
- soft starter
- light and temperature control

Advantages

- Easy to mount with two screws
- Space and weight savings
- Improved temperature and power cycling
- High power density

Data according to IEC 60747 and to a single thyristor/diode unless otherwise stated.

IXYS reserves the right to change limits, Conditions and dimensions.

© 2006 IXYS All rights reserved

Symbol	Conditions	Characteristic Values	
$I_{RRM/DRM}$	$T_{VJ} = 125^{\circ}\text{C}; V_R = V_{RRM}; V_D = V_{DRM}$	\leq	3 mA
V_T	$I_T = 50; T_{VJ} = 25^{\circ}\text{C}$	\leq	1.3 V
V_{T0}	For power-loss calculations only		0.9 V
r_T			5.8 m Ω
V_{GT}	$V_D = 6\text{ V}; T_{VJ} = 25^{\circ}\text{C}$	\leq	1.4 V
	$T_{VJ} = -40^{\circ}\text{C}$	\leq	1.6 V
I_{GT}	$V_D = 6\text{ V}; T_{VJ} = 25^{\circ}\text{C}$	\leq	80 mA
	$T_{VJ} = -40^{\circ}\text{C}$	\leq	120 mA
V_{GD}	$T_{VJ} = T_{VJM}; V_D = \frac{2}{3} V_{DRM}$	\leq	0.2 V
I_{GD}		\leq	5 mA
I_L	$T_{VJ} = 25^{\circ}\text{C}; t_P = 10\ \mu\text{s}$ $I_G = 0.3\text{ A}; di_G/dt = 0.3\text{ A}/\mu\text{s}$	\leq	450 mA
I_H	$T_{VJ} = 25^{\circ}\text{C}; V_D = 6\text{ V}; R_{GK} = \infty$	\leq	100 mA
t_{gd}	$T_{VJ} = 25^{\circ}\text{C}; V_D = \frac{1}{2} V_{DRM}$ $I_G = 0.3\text{ A}; di_G/dt = 0.3\text{ A}/\mu\text{s}$	\leq	2 μs
t_q	$T_{VJ} = T_{VJM}; I_T = 11\text{ A}, t_P = 200\ \mu\text{s}; di/dt = -10\text{ A}/\mu\text{s}$ $V_R = 100\text{ V}; dv/dt = 15\text{ V}/\mu\text{s}; V_D = \frac{2}{3} V_{DRM}$	typ.	150 μs
R_{thJC}	DC current		0.72 K/W
R_{thCH}	DC current	typ.	0.4 K/W
d_S	Creeping distance on surface		8 mm
d_A	Creepage distance in air		4 mm
a	Max. allowable acceleration		50 m/s ²

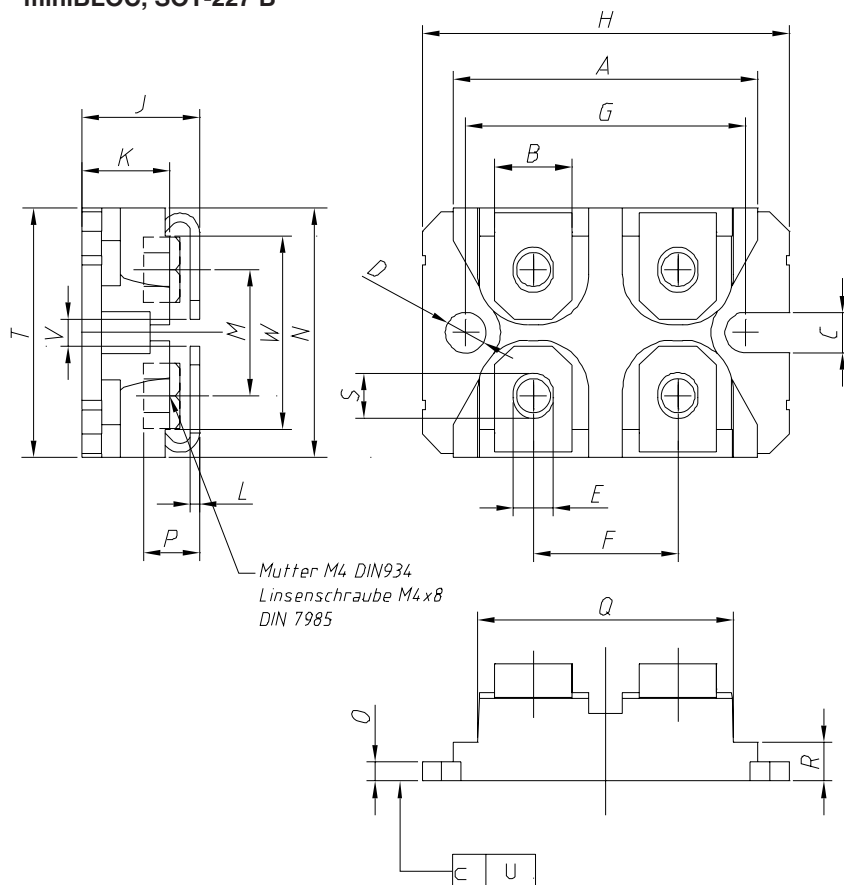
miniBLOC, SOT-227 B

M4 screws (4x) supplied

Dim.	Millimeter		Inches	
	Min.	Max.	Min.	Max.
A	31.50	31.88	1.240	1.255
B	7.80	8.20	0.307	0.323
C	4.09	4.29	0.161	0.169
D	4.09	4.29	0.161	0.169
E	4.09	4.29	0.161	0.169
F	14.91	15.11	0.587	0.595
G	30.12	30.30	1.186	1.193
H	37.80	38.23	1.489	1.505
J	11.68	12.22	0.460	0.481
K	8.92	9.60	0.351	0.378
L	0.76	0.84	0.030	0.033
M	12.60	12.85	0.496	0.506
N	25.15	25.42	0.990	1.001
O	1.98	2.13	0.078	0.084
P	4.95	5.97	0.195	0.235
Q	26.54	26.90	1.045	1.059
R	3.94	4.42	0.155	0.174
S	4.72	4.85	0.186	0.191
T	24.59	25.07	0.968	0.987
U	-0.05	0.1	-0.002	0.004
V	3.30	4.57	0.130	0.180
W	0.780	0.830	0.031	0.032

IXYS reserves the right to change limits, Conditions and dimensions.