

Triacs

BT134W series

GENERAL DESCRIPTION

Glass passivated triacs in a plastic envelope suitable for surface mounting, intended for use in applications requiring high bidirectional transient and blocking voltage capability and high thermal cycling performance. Typical applications include motor control, industrial and domestic lighting, heating and static switching.

QUICK REFERENCE DATA

SYMBOL	PARAMETER	MAX.	MAX.	MAX.	UNIT
		BT134W- BT134W- BT134W- 500 500F 500G	600 600F 600G	800 800F 800G	
V_{DRM}	Repetitive peak off-state voltages	500	600	800	V
$I_{T(RMS)}$	RMS on-state current	1	1	1	A
I_{TSM}	Non-repetitive peak on-state current	10	10	10	A

PINNING - SOT223

PIN	DESCRIPTION
1	main terminal 1
2	main terminal 2
3	gate
tab	main terminal 2

PIN CONFIGURATION

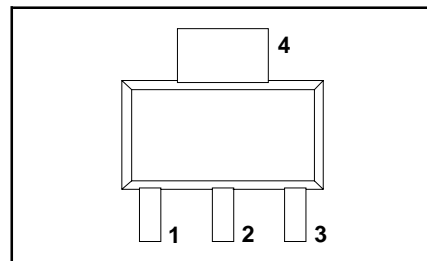

SYMBOL

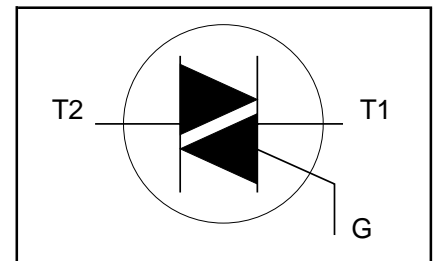

LIMITING VALUES

Limiting values in accordance with the Absolute Maximum System (IEC 134).

SYMBOL	PARAMETER	CONDITIONS	MIN.	MAX.			UNIT
				-500 500 ¹	-600 600 ¹	-800 800	
V_{DRM}	Repetitive peak off-state voltages		-				V
$I_{T(RMS)}$	RMS on-state current	full sine wave; $T_{sp} \leq 108^\circ\text{C}$	-	1			A
I_{TSM}	Non-repetitive peak on-state current	full sine wave; $T_j = 25^\circ\text{C}$ prior to surge	-	10			A
		$t = 20\text{ ms}$	-	11			A
		$t = 16.7\text{ ms}$	-	0.5			A ² s
		$t = 10\text{ ms}$	-				
I^2t	I^2t for fusing		-				
di_T/dt	Repetitive rate of rise of on-state current after triggering	$I_{TM} = 1.5\text{ A}; I_G = 0.2\text{ A}; di_G/dt = 0.2\text{ A}/\mu\text{s}$	-				
		T2+ G+	-	50			A/ μs
		T2+ G-	-	50			A/ μs
		T2- G-	-	50			A/ μs
		T2- G+	-	10			A/ μs
I_{GM}	Peak gate current		-	2			A
V_{GM}	Peak gate voltage		-	5			V
P_{GM}	Peak gate power		-	5			W
$P_{G(AV)}$	Average gate power		-	0.5			W
T_{stg}	Storage temperature		-40	150			$^\circ\text{C}$
T_j	Operating junction temperature	over any 20 ms period	-	125			$^\circ\text{C}$

¹ Although not recommended, off-state voltages up to 800V may be applied without damage, but the triac may switch to the on-state. The rate of rise of current should not exceed 3 A/ μs .

Triacs

BT134W series

THERMAL RESISTANCES

SYMBOL	PARAMETER	CONDITIONS	MIN.	TYP.	MAX.	UNIT
$R_{th\ j-sp}$	Thermal resistance junction to solder point	full or half cycle	-	-	15	K/W
$R_{th\ j-a}$	Thermal resistance junction to ambient	pcb mounted; minimum footprint pcb mounted; pad area as in fig:14	-	156 70	-	K/W K/W

STATIC CHARACTERISTICS

 $T_j = 25\text{ }^\circ\text{C}$ unless otherwise stated

SYMBOL	PARAMETER	CONDITIONS	MIN.	TYP.	MAX.			UNIT
I_{GT}	Gate trigger current	BT134W- $V_D = 12\text{ V}; I_T = 0.1\text{ A}$	-	-F	...G	
		T2+ G+	-	5	35	25	50	mA
		T2+ G-	-	8	35	25	50	mA
		T2- G-	-	11	35	25	50	mA
		T2- G+	-	30	70	70	100	mA
I_L	Latching current	$V_D = 12\text{ V}; I_{GT} = 0.1\text{ A}$	-	-	-	-	-	
		T2+ G+	-	7	20	20	30	mA
		T2+ G-	-	16	30	30	45	mA
		T2- G-	-	5	20	20	30	mA
		T2- G+	-	7	30	30	45	mA
I_H	Holding current	$V_D = 12\text{ V}; I_{GT} = 0.1\text{ A}$	-	5	15	15	30	mA
V_T	On-state voltage	$I_T = 2\text{ A}$	-	1.2	1.50			V
V_{GT}	Gate trigger voltage	$V_D = 12\text{ V}; I_T = 0.1\text{ A}$	-	0.7	1.5			V
		$V_D = 400\text{ V}; I_T = 0.1\text{ A};$ $T_j = 125\text{ }^\circ\text{C}$	0.25	0.4	-			V
I_D	Off-state leakage current	$V_D = V_{DRM(max)};$ $T_j = 125\text{ }^\circ\text{C}$	-	0.1	0.5			mA

DYNAMIC CHARACTERISTICS

 $T_j = 25\text{ }^\circ\text{C}$ unless otherwise stated

SYMBOL	PARAMETER	CONDITIONS	MIN.			TYP.	MAX.	UNIT
dV_D/dt	Critical rate of rise of off-state voltage	BT134W- $V_{DM} = 67\% V_{DRM(max)};$ $T_j = 125\text{ }^\circ\text{C};$ exponential waveform; gate open circuitF	...G	250	-	V/ μs
dV_{com}/dt	Critical rate of change of commutating voltage	$V_{DM} = 400\text{ V}; T_j = 95\text{ }^\circ\text{C};$ $I_{T(RMS)} = 1\text{ A};$ $dl_{com}/dt = 1.8\text{ A/ms};$ gate open circuit	-	-	10	50	-	V/ μs
t_{gt}	Gate controlled turn-on time	$I_{TM} = 1.5\text{ A};$ $V_D = V_{DRM(max)};$ $I_G = 0.1\text{ A};$ $dl_G/dt = 5\text{ A}/\mu\text{s};$	-	-	-	2	-	μs

Triacs

BT134W series

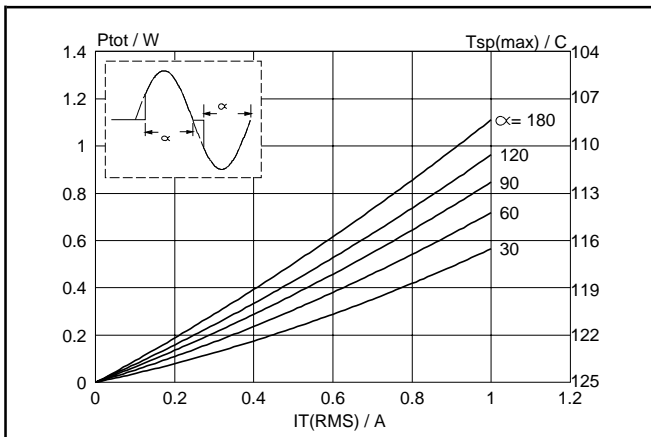

Fig.1. Maximum on-state dissipation, P_{tot} , versus rms on-state current, $I_{T(RMS)}$, where $\alpha =$ conduction angle.

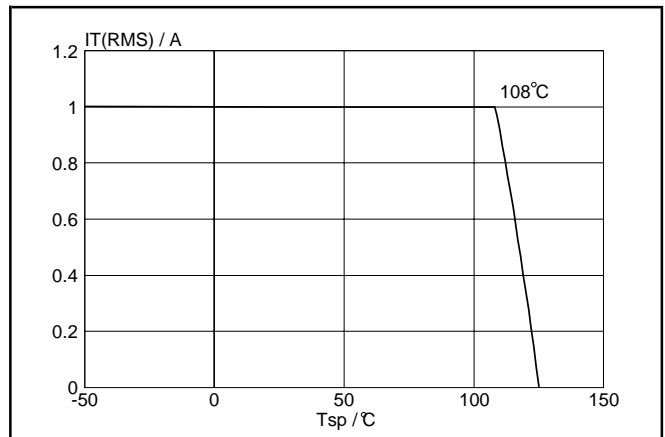

Fig.4. Maximum permissible rms current $I_{T(RMS)}$, versus solder point temperature T_{sp} .

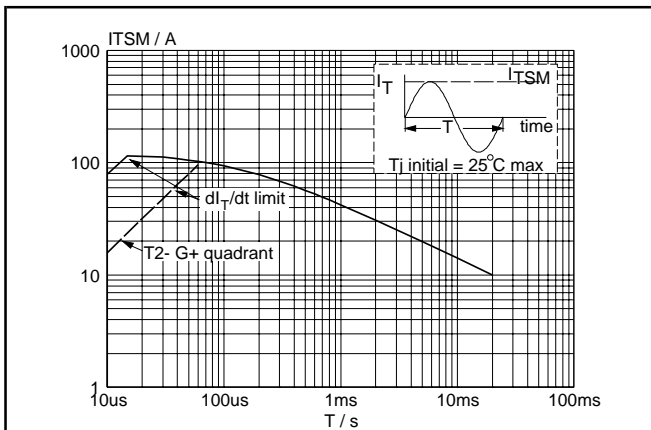

Fig.2. Maximum permissible non-repetitive peak on-state current I_{TSM} , versus pulse width t_p , for sinusoidal currents, $t_p \leq 20ms$.

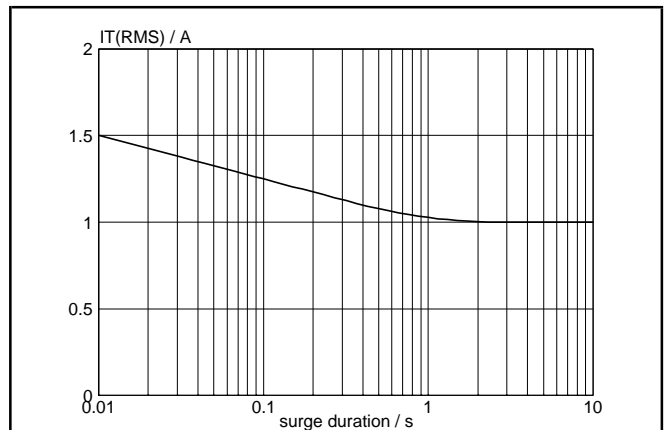

Fig.5. Maximum permissible repetitive rms on-state current $I_{T(RMS)}$, versus surge duration, for sinusoidal currents, $f = 50 Hz$; $T_{sp} \leq 108^\circ C$.

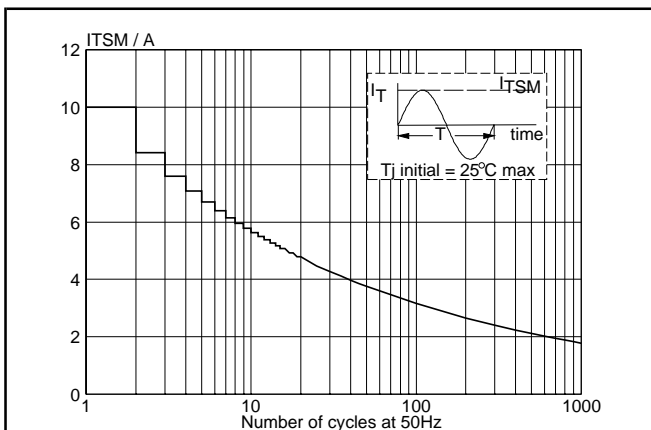

Fig.3. Maximum permissible non-repetitive peak on-state current I_{TSM} , versus number of cycles, for sinusoidal currents, $f = 50 Hz$.



Fig.6. Normalised gate trigger voltage $V_{GT}(T_j) / V_{GT}(25^\circ C)$, versus junction temperature T_j .

Triacs

BT134W series

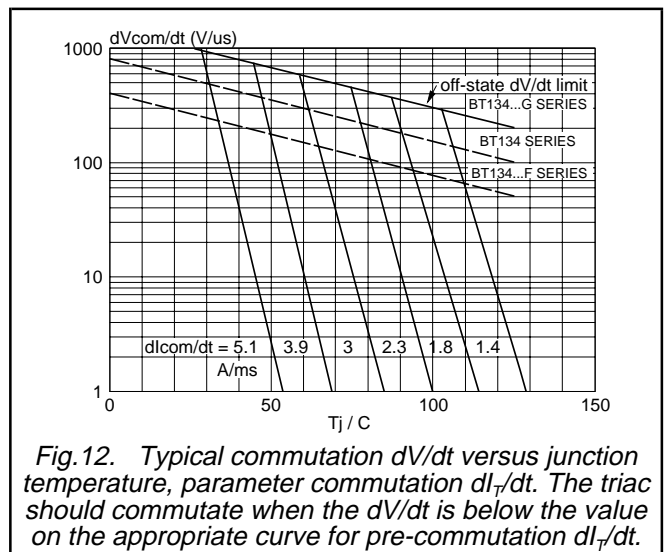
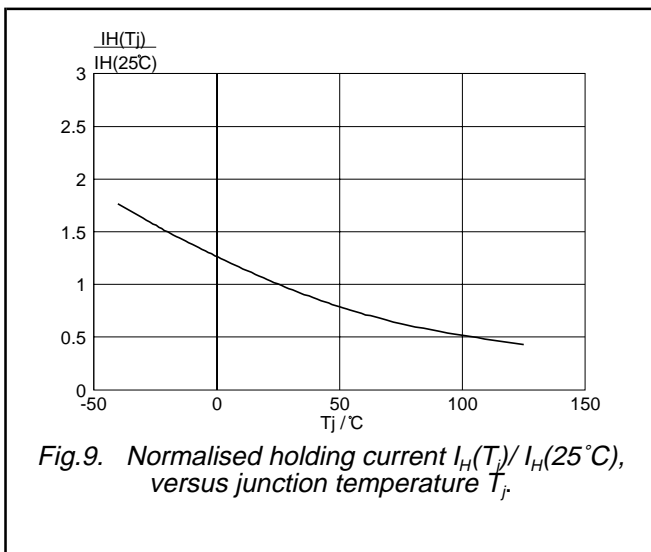
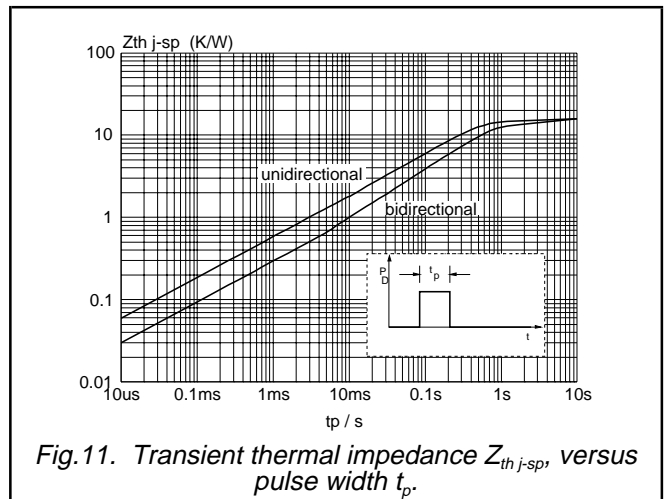
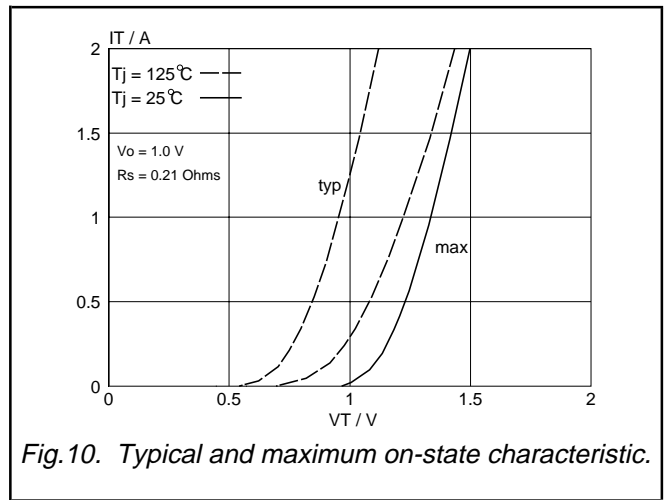
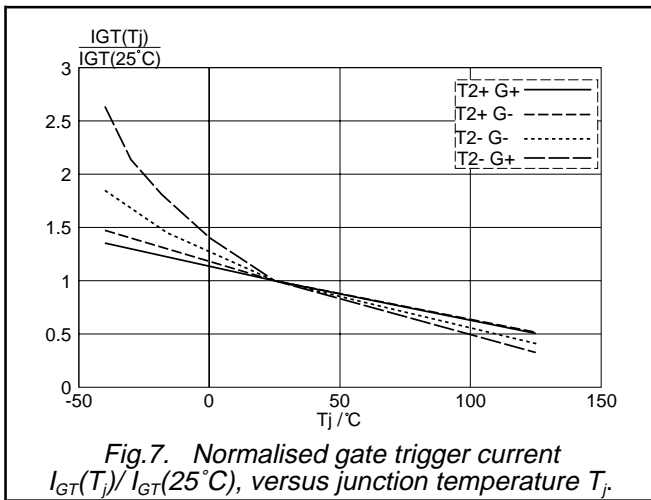

MOUNTING INSTRUCTIONS

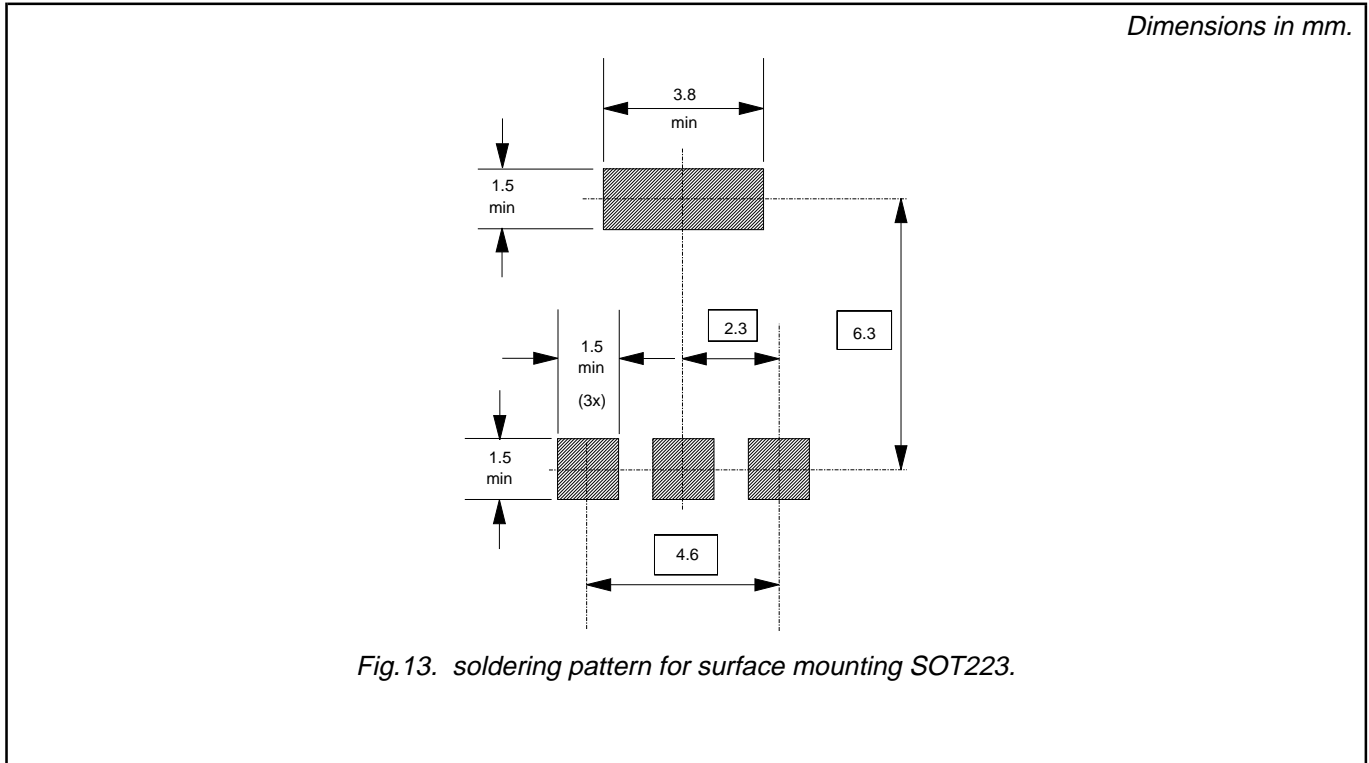

PRINTED CIRCUIT BOARD

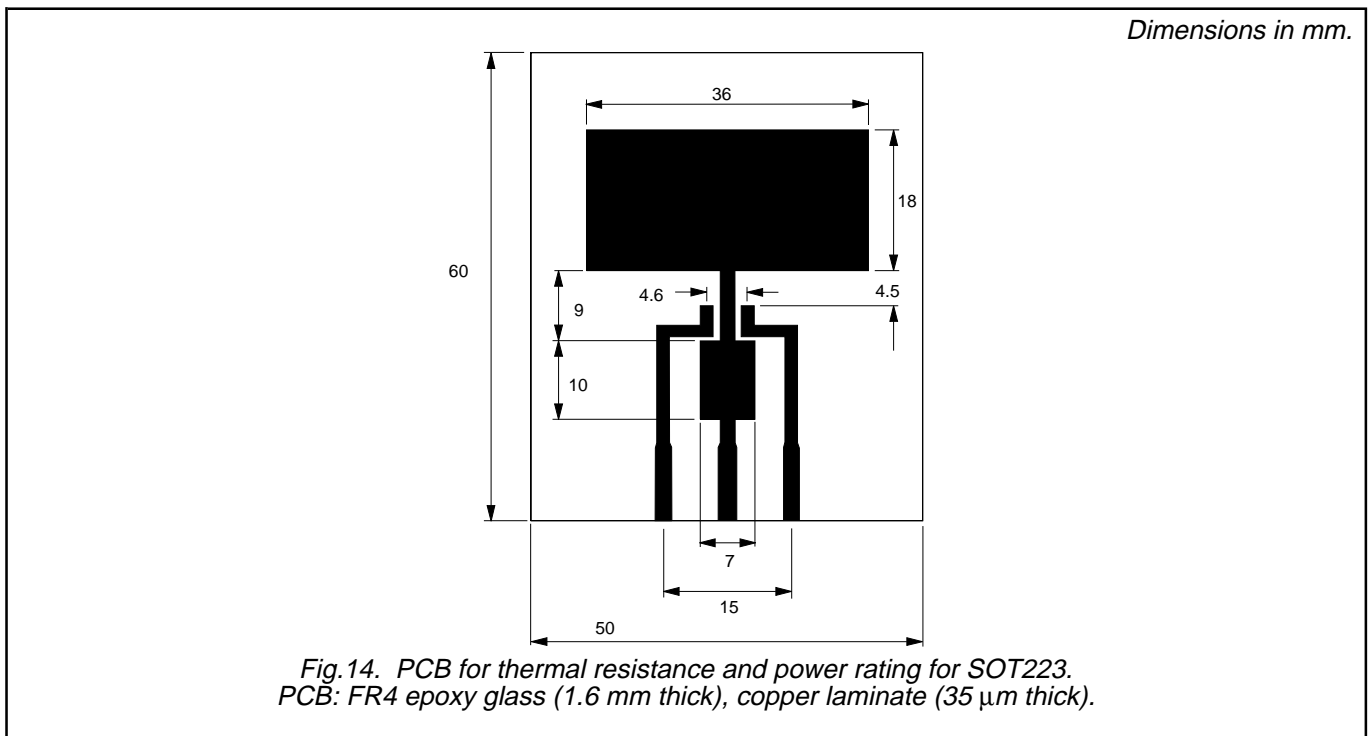

Triacs

BT134W series

MECHANICAL DATA

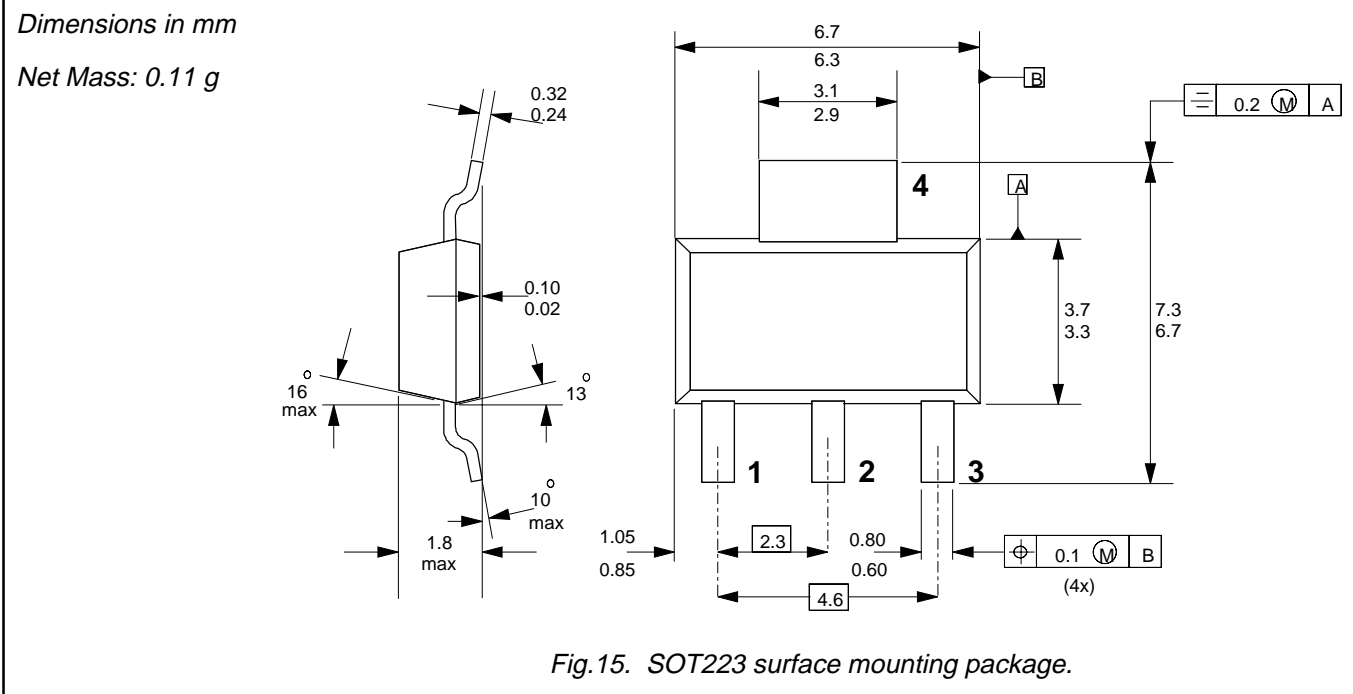

Notes

1. For further information, refer to Philips publication SC18 " SMD Footprint Design and Soldering Guidelines".
 Order code: 9397 750 00505.
2. Epoxy meets UL94 V0 at 1/8".

Triacs

BT134W series

DEFINITIONS

Data sheet status	
Objective specification	This data sheet contains target or goal specifications for product development.
Preliminary specification	This data sheet contains preliminary data; supplementary data may be published later.
Product specification	This data sheet contains final product specifications.
Limiting values	
Limiting values are given in accordance with the Absolute Maximum Rating System (IEC 134). Stress above one or more of the limiting values may cause permanent damage to the device. These are stress ratings only and operation of the device at these or at any other conditions above those given in the Characteristics sections of this specification is not implied. Exposure to limiting values for extended periods may affect device reliability.	
Application information	
Where application information is given, it is advisory and does not form part of the specification.	
© Philips Electronics N.V. 1997	
All rights are reserved. Reproduction in whole or in part is prohibited without the prior written consent of the copyright owner.	
The information presented in this document does not form part of any quotation or contract, it is believed to be accurate and reliable and may be changed without notice. No liability will be accepted by the publisher for any consequence of its use. Publication thereof does not convey nor imply any license under patent or other industrial or intellectual property rights.	

LIFE SUPPORT APPLICATIONS

These products are not designed for use in life support appliances, devices or systems where malfunction of these products can be reasonably expected to result in personal injury. Philips customers using or selling these products for use in such applications do so at their own risk and agree to fully indemnify Philips for any damages resulting from such improper use or sale.