



■ Features

- Input range 180~264VAC
- Class II power unit, no FG
- Built-in active PFC function
- High efficiency up to 94%
- No load power consumption <0.15W
- Energy efficiency Level VI
- Comply with EU ErP and CoC Version 5
- Compliance to IEC/EN 61558-1,-2-16 and IEC/EN 60335-1 (except for OWA-200E-48,54) for household appliance
- Fanless design, cooling by free air convection
- Protections: Short circuit / Overload / Over voltage / Over temperature
- 5 years warranty
- [Various DC plug quick adapter accessory available](#) (Plug kit sold sperately, please refer to : https://www.meanwell.com/upload/pdf/DC_plug.pdf)

■ Applications

- Industrial field PC adaptor
- POS or KIOSK system
- Portable Battery charger
- Electric Lawn mower charger
- General electronic products in dusty or humid environment
- Household Device

■ GTIN CODE

MW Search: <https://www.meanwell.com/serviceGTIN.aspx>

■ Description

OWA-200E is a 200W AC/DC, class II (no FG) external power supply series pinpointing the moistureproof feature. The fully-potted silicone inside the plastic enclosure enhances the heat dissipation; it also benefits that the power body of OWA-200E achieves IP67 level so that this series specializes the application in which the damp, humidity or dust resistance is needed for the external power supply. OWA-200E follows the latest energy efficiency demand with the no load power consumption less than 0.15W. It is certified with EN61558-2-16; moreover, the compliance to EN60335-1 for selected models can greatly simplify the system design such as household or charging application.

OWA-200E adopts the input range from 180VAC to 264VAC and incorporates a built-in PFC function. With the working efficiency up to 94%, OWA-200E is cooled by free air convection; the working temperature ranges from -40°C to +70°C .

■ Model Encoding

OWA - 200E - 12

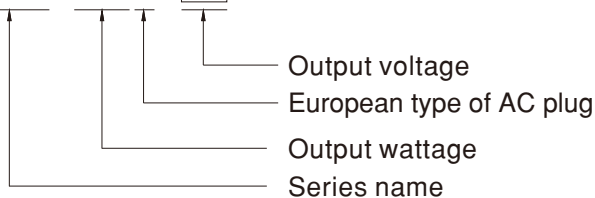

**SPECIFICATION**

MODEL		OWA-200E-12	OWA-200E-20	OWA-200E-24	OWA-200E-36	OWA-200E-42	OWA-200E-48	OWA-200E-54
OUTPUT	DC VOLTAGE	12V	20V	24V	36V	42V	48V	54V
	RATED CURRENT	15A	10A	8.3A	5.55A	4.75A	4.17A	3.71A
	RATED POWER	180W	200W	199W	199W	199W	200W	200W
	RIPPLE & NOISE (max.) Note.2	150mVp-p	150mVp-p	150mVp-p	200mVp-p	250mVp-p	250mVp-p	350mVp-p
	VOLTAGE TOLERANCE Note.3	±5.0%	±4.0%	±4.0%	±3.0%	±3.0%	±3.0%	±3.0%
	LINE REGULATION	±0.5%	±0.5%	±0.5%	±0.5%	±0.5%	±0.5%	±0.5%
	LOAD REGULATION	±5.0%	±4.0%	±4.0%	±3.0%	±3.0%	±3.0%	±3.0%
	SETUP, RISE TIME Note.4	500ms, 80ms 230VAC						
	HOLD UP TIME (Typ.)	10ms at full load 230VAC						
INPUT	VOLTAGE RANGE	180 ~ 264VAC 254 ~ 370VDC						
	FREQUENCY RANGE	47 ~ 63Hz						
	POWER FACTOR (Typ.)	PF>0.96/230VAC at full load						
	EFFICIENCY(Typ.)	91%	92.5%	93%	94%	94%	94%	94%
	AC CURRENT (Typ.)	1.1A / 230VAC						
	INRUSH CURRENT (Typ.)	COLD START 65A(twidth=550µs measured at 50% Ipeak) at 230VAC						
	LEAKAGE CURRENT	<0.25mA / 240VAC						
	NO LOAD CONSUMPTION	<0.15W						
PROTECTION	OVER CURRENT	105% ~ 150%						
		Protection type : Hiccup mode, recovers automatically after fault condition is removed						
	SHORT CIRCUIT	Hiccup mode, recovers automatically after fault condition is removed						
	OVER VOLTAGE	13 ~ 18V	22 ~ 27V	27 ~ 34V	41 ~ 49V	46 ~ 57V	52 ~ 65V	59 ~ 70V
		Protection type : Shut down o/p voltage, re-power on to recover						
	OVER TEMPERATURE	Shut down o/p voltage, re-power on to recover						
ENVIRONMENT	WORKING TEMP.	-40 ~ +70°C (Refer to "Derating Curve")						
	WORKING HUMIDITY	20 ~ 95% RH non-condensing						
	STORAGE TEMP., HUMIDITY	-40 ~ +80°C, 10 ~ 95% RH						
	TEMP. COEFFICIENT	±0.03%/°C (0 ~ 50°C)						
	VIBRATION	10 ~ 500Hz, 5G 12min./1cycle, period for 72min. each along X, Y, Z axes						
SAFETY & EMC	SAFETY STANDARDS	DEKRA EN61558-1,-2-16; DEKRA EN60335-1(except for OWA-200E-48,54); EAC TP TC 004, IP67 (for power body) approved						
	WITHSTAND VOLTAGE	I/P-O/P:4.2KVAC						
	ISOLATION RESISTANCE	I/P-O/P:100M Ohms / 500VDC / 25°C / 70% RH						
	EMC EMISSION	Compliance to EN55032(CISPR32)ClassB, EN55035, EN55014-1, EN61000-3-2/3; EAC TP TC 020						
	EMC IMMUNITY	Compliance to EN61000-4-2,3,4,5,6,8,11,EN55014-2,EN55024, light industry level (surge L-N: 2KV), EAC TP TC 020						
OTHERS	MTBF	2677.8K hrs min. Telcordia SR-332 (Bellcore) 267.6K hrs min. MIL-HDBK-217F (25°C)						
	DIMENSION	195*68*39.5mm						
	PACKING	1.32Kg; 9pcs/ 12.88Kg/ 0.79CUFT						
NOTE	<p>1. All parameters NOT specially mentioned are measured at 230VAC input, rated load and 25°C of ambient temperature.</p> <p>2. Ripple & noise are measured at 20MHz of bandwidth by using a 12" twisted pair-wire terminated with a 0.1uf & 47uf parallel capacitor.</p> <p>3. Tolerance : includes set up tolerance, line regulation and load regulation.</p> <p>4. Length of set up time is measured at cold first start. Turning ON/OFF the power supply may lead to increase of the set up time.</p> <p>5. For battery charging purpose had better operation with a BMS controller.</p> <p>※ Product Liability Disclaimer : For detailed information, please refer to https://www.meanwell.com/serviceDisclaimer.aspx</p>							

Block Diagram

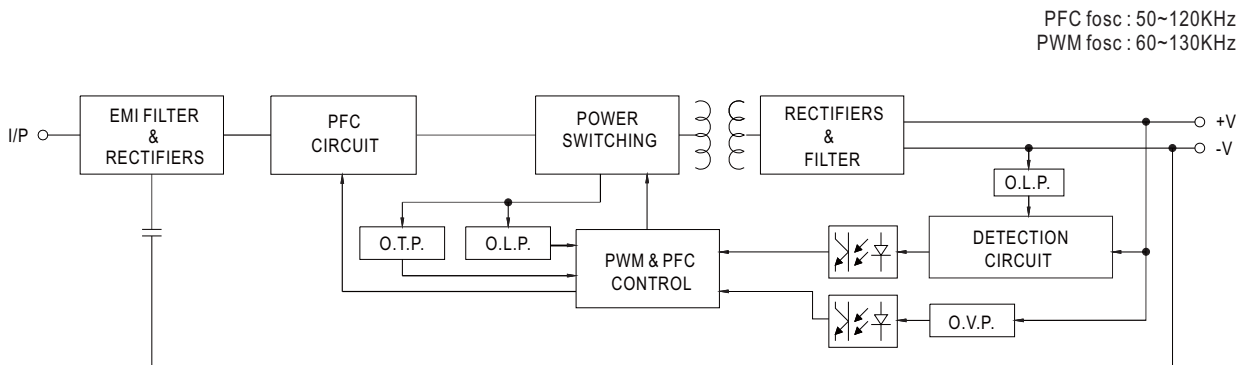

Derating Curve

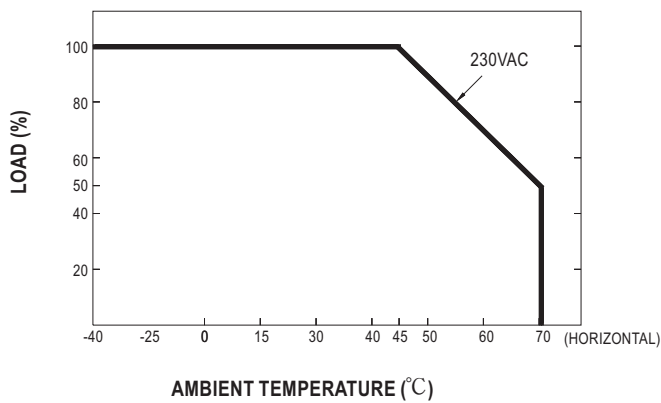

Static Characteristics

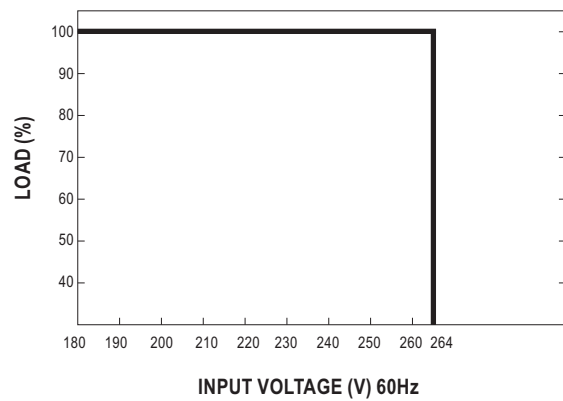

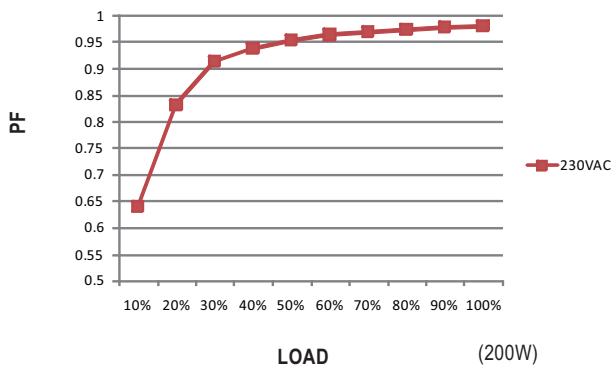

Power Factor Characteristic

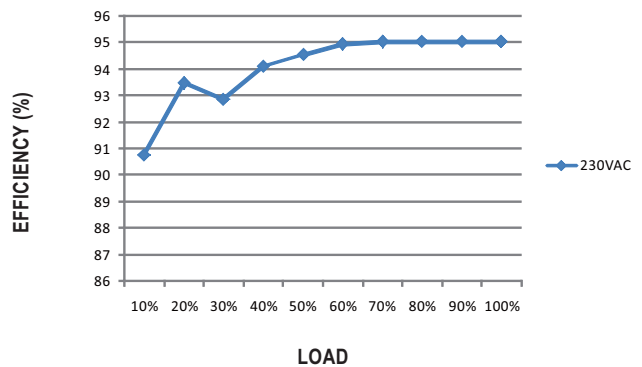

EFFICIENCY vs LOAD (48V Model)

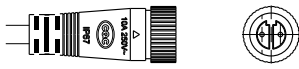
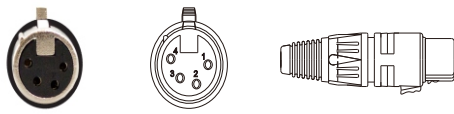

KYCON KPPX-4P equivalent	Type No.	Pin Assignment		Available for all model (Current rating: 15A max.)
		PIN No.	Output	
	R7B	1	+Vo	
		2	-Vo	
		3	-Vo	
		4	+Vo	
LLT-M19-20002F307 equivalent	Type No.	Pin Assignment		Available for all model (Current rating: 15A max.)
	M19	PIN No.	Output	
		1	+Vo	
		2	-Vo	
DW-M15-02F equivalent	Type No.	Pin Assignment		Available for 20V/24V/36V/48V/54V (Current rating: 10A max.)
	M15	PIN No.	Output	
		1	+Vo	
		2	-Vo	
NEUTRIK XLR NC4FX equivalent	Type No.	Pin Assignment		Available for all model (Current rating: 15A max.)
	MIC4	PIN No.	Output	
		1	+Vo	
		2	+Vo	
		3	-Vo	
		4	-Vo	

※ For details, please contact MEAN WELL.

■ Recommend Mounting Direction



■ Installation Manual

Please refer to : <http://www.meanwell.com/manual.html>