

HIGH SPEED SINGLE SUPPLY OPERATIONAL AMPLIFIER

■FEATURES

- High Slew Rate 10V/μs
- High Bandwidth 3MHz
- High Unity Gain Frequency 3.6MHz
- Input Offset Voltage 5.5mV max.
- Single Supply 3V to 36V
- Operating Temperature Range -40°C to +125°C
- Low input voltage around GND level
- Unity-Gain Stable
- No Phase Reversal
- High EMI Immunity
- Output Short-Circuit Protection
- Operating Current (All amplifiers)
 - NJM3472 4mA
 - NJM3474 8mA
- Package
 - NJM3472 SOP8, SSOP8, MSOP8(VSP8)
 - NJM3474 SOP14, SSOP14

■GENERAL DESCRIPTION

The NJM3472/NJM3474 are high speed single supply operational amplifier.

10V/μs slew rate, 3MHz gain bandwidth and 5.5mV max. offset voltage are suitable for inverter current sense application, motor load current sense application and active filter.

As a further feature, operation voltage range from 3V to 36V and operation temperature range from -40 to +125°C are suitable for general-purpose inverters, power supply unit and high performance home appliance. Compared with the TL3472/TL3474, the characteristics of low-power are improved.

■APPLICATIONS

- Motor, Inverter Current Sense Application
- Power Supply Application
- Buffer Application Amplifier
- Active filter

■PIN CONFIGURATION / PRODUCT INFORMATION

PIN FUNCTION	<p>(Top View)</p> <p>A OUTPUT 1, A -INPUT 2, A +INPUT 3, V- 4, V+ 8, B OUTPUT 7, B -INPUT 6, B +INPUT 5</p>			<p>(Top View)</p> <p>A OUTPUT 1, A -INPUT 2, A +INPUT 3, V+ 4, B +INPUT 5, B -INPUT 6, B OUTPUT 7, D OUTPUT 14, D -INPUT 13, D +INPUT 12, V- 11, C +INPUT 10, C -INPUT 9, C OUTPUT 8</p>		
PACKAGE	 SOP8	 SSOP8	 MSOP8(VSP8)	 SOP14	 SSOP14	
PART NUMBER	NJM3472G	NJM3472V	NJM3472R	NJM3474G	NJM3474V	

■ABSOLUTE MAXIMUM RATINGS (Ta=25°C, unless otherwise noted.)

PARAMETER	SYMBOL	RATING	UNIT
Supply Voltage	$V^+ - V^-$	40 ⁽⁵⁾	V
Differential Input Voltage ⁽¹⁾	V_{ID}	± 40 ⁽²⁾	V
Input Voltage ⁽²⁾	V_{IN}	$V^- - 0.3$ to $V^- + 40$	V
Output Terminal Input Voltage	V_O	$V^- - 0.3$ to $V^+ + 0.3V$	V
Power Dissipation ⁽³⁾	P_D	(2-layer / 4-layer)	mW
SOP8		780 / 1200	
SSOP8		510 / 650	
MSOP8(VSP8)		600 / 810	
SOP14		1200 / 1900	
SSOP14		600 / 770	
Output Short-Circuit Duration ⁽⁴⁾		infinite	
Operating Temperature Range	T_{opr}	-40 to +125	°C
Storage Temperature Range	T_{stg}	-55 to +150	°C

(1) Differential voltage is the voltage difference between +INPUT and -INPUT.

(2) Input voltage should be allowed to apply to the input terminal independent of the magnitude of V^+ . The normal operation will establish when any input is within the Common Mode Voltage Range of electrical characteristics.

(3) Power dissipation is the power that can be consumed by the IC at $T_a=25^\circ\text{C}$, and is the typical measured value based on JEDEC condition. When using the IC over $T_a=25^\circ\text{C}$ subtract the value $[\text{mW}/^\circ\text{C}] = P_D / (T_{stg}(\text{MAX}) - 25)$ per temperature.

2-layer: EIA/JEDEC STANDARD Test board (76.2x114.3x1.6mm, 2layers, FR-4) mounting

4-layer: EIA/JEDEC STANDARD Test board (76.2x114.3x1.6mm, 4layers, FR-4) mounting

(4) Temperature and/or supply voltages must be limited to ensure the maximum dissipation rating is not exceeded.

(5) Supply Voltage is the voltage difference between V^+ and V^- .

Figure1A. Power Dissipation vs. Temperature

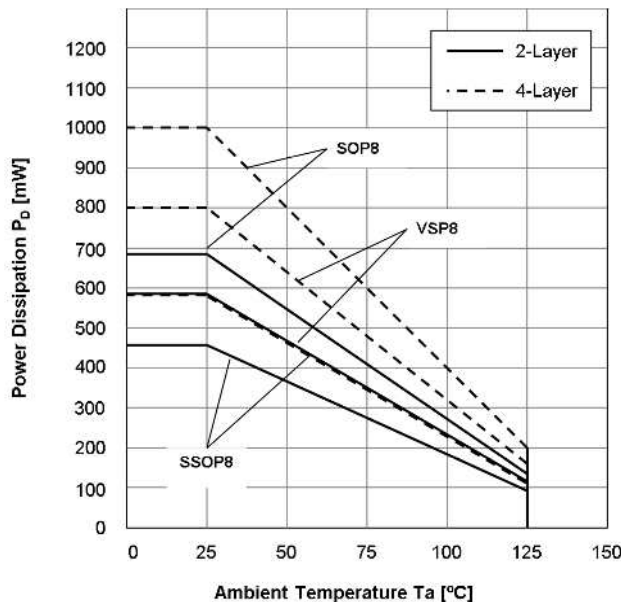
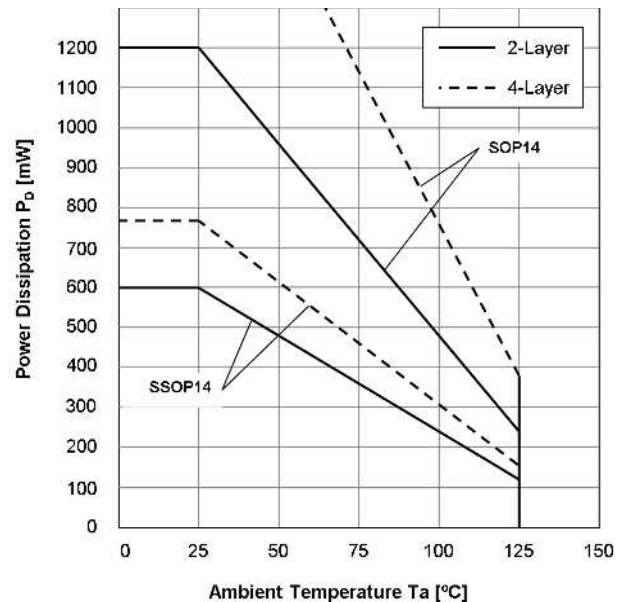

Figure1B. Power Dissipation vs. Temperature



■RECOMMENDED OPERATING CONDITIONS (Ta=25°C)

PARAMETER	Supply Voltage	UNIT
Supply Voltage	+3 to +36 (± 1.5 to ± 18)	V

■ELECTRICAL CHARACTERISTICS ($V^+=+15V$, $V^-=-15V$, $V_{CM}=0V$, $T_a=25^\circ C$ unless otherwise noted)

PARAMETER	SYMBOL	TEST CONDITION	MIN.	TYP.	MAX.	UNIT
INPUT CHARACTERISTICS						
Input Offset Voltage	V_{IO}	$R_S=50\Omega$, $V_{CM}=0V$	-	1	5.5	mV
Input Offset Voltage Drift	$\Delta V_{IO}/\Delta T$	$T_a=-40^\circ C\sim+125^\circ C$	-	10	-	$\mu V/^\circ C$
Input Bias Current	I_B		-	80	150	nA
Input Offset Current	I_{IO}		-	5	75	nA
Open-Loop Voltage Gain	A_V	$V_O=\pm 10V$, $R_L=2k\Omega$ to $0V$	80	95	-	dB
Common Mode Rejection Ratio	CMR	$V_{ICM}=-15V$ to $13.0V$	60	100	-	dB
Common Mode Input Voltage Range	V_{ICM}	CMR ≥ 60 dB	V^-	-	$V^+-2.0$	V
OUTPUT CHARACTERISTICS						
High-level Output Voltage	V_{OH}	$R_L=10k\Omega$ to $0V$	13.7	14	-	V
		$R_L=2k\Omega$ to $0V$	13.5	13.8	-	
Low-level Output Voltage	V_{OL}	$R_L=10k\Omega$ to $0V$	-	-14.8	-14.3	V
		$R_L=2k\Omega$ to $0V$	-	-13.8	-13.5	
Output Source Current	I_{SOURCE}	$V_O=0V$, +Input= $+1V$, -Input= $0V$	10	35	-	mA
Output Sink Current	I_{SINK}	$V_O=0V$, +Input= $0V$, -Input= $+1V$	20	60	-	mA
POWER SUPPLY						
Supply Current (All amplifiers) NJM3472 NJM3474	I_{SUPPLY}	No Signal, $R_L=\infty$	-	4	5	mA
			-	8	10	
Supply Voltage Rejection Ratio	SVR	$V^+/V^-=\pm 2V$ to $\pm 18V$, $V_{ICM}=0V$	60	95	-	dB
AC CHARACTERISTICS						
Gain Bandwidth Product	GBW	$R_L=2k\Omega$ to $0V$, $f=100kHz$	-	3	-	MHz
Unity Gain Frequency	f_T	$R_L=2k\Omega$ to $0V$	-	3.6	-	MHz
Slew Rate	SR	$G_V=0dB$, $V_{in}=-10V$ to $+10V$, $R_L=2k\Omega$ to $0V$, $C_L=20pF$	7.5	10	-	V/ μs
Full Power Bandwidth	FPBW	$G_V=0dB$, $V_O=20V_{pp}$, THD=5.0%, $R_L=2k\Omega$ to $0V$, $C_L=20pF$	-	190	-	kHz
Settling Time	t_s	$G_V=0dB$, 10V step To 0.1%	-	1.8	-	μs
		$G_V=0dB$, 10V step To 0.01%	-	12	-	
Phase Margin	ϕ_M	$R_L=2k\Omega$ to $0V$, $C_L=20pF$	-	78	-	deg
		$R_L=2k\Omega$ to $0V$, $C_L=220pF$	-	68	-	
Gain Margin	G_M	$R_L=2k\Omega$ to $0V$, $C_L=20pF$	-	12	-	dB
		$R_L=2k\Omega$ to $0V$, $C_L=220pF$	-	6	-	
NOISE, THD						
Equivalent Input Noise Voltage	e_n	$f=1kHz$	-	48	-	nV/ \sqrt{Hz}
Total Harmonic Distortion + Noise	THD+N	$G_V=0dB$, $f=10kHz$, $V_O=20V_{pp}$, $R_L=2k\Omega$ to $0V$, $C_L=20pF$	-	0.02	-	%
Channel Separation	CS	$f=1kHz$, Equivalent Input value	-	120	-	dB

■ELECTRICAL CHARACTERISTICS ($V^+=+5V$, $V^-=0V$, $V_{CM}=2.5V$, $T_a=25^\circ C$ unless otherwise noted)

PARAMETER	SYMBOL	TEST CONDITION	MIN.	TYP.	MAX.	UNIT
INPUT CHARACTERISTICS						
Input Offset Voltage	V_{IO}	$R_S=50\Omega$, $V_{CM}=0V$, $V_o=V^+/2$	-	1	5.5	mV
Input Offset Voltage Drift	$\Delta V_{IO}/\Delta T$	$T_a=-40^\circ C \sim +125^\circ C$	-	10	-	$\mu V/^\circ C$
Input Bias Current	I_B	$V_{CM}=V^+/2$, $V_o=V^+/2$	-	80	150	nA
Input Offset Current	I_{IO}	$V_{CM}=V^+/2$, $V_o=V^+/2$	-	5	75	nA
Open-Loop Voltage Gain	A_V	$V_o=1.5V$ to $3.5V$, $R_L=2k\Omega$ to $V^+/2$	80	95	-	dB
Common Mode Rejection Ratio	CMR	$V_{CM}=0V$ to $3V$	60	90	-	dB
Common Mode Input Voltage Range	V_{ICM}	CMR ≥ 60 dB	V^-	-	$V^+-2.0$	V
OUTPUT CHARACTERISTICS						
High-level Output Voltage	V_{OH}	$R_L=2k\Omega$ to $0V$	3.7	4	-	V
Low-level Output Voltage	V_{OL}	$R_L=2k\Omega$ to $0V$	-	0.1	0.3	V
Output Source Current	I_{SOURCE}	$V_o=0V$	10	28	-	mA
Output Sink Current	I_{SINK}	$V_o=5V$	20	60	-	mA
POWER SUPPLY						
Supply Current (All amplifiers) NJM3472 NJM3474	I_{SUPPLY}	No Signal, $R_L=\infty$	- -	3.3 6.6	4.5 9	mA mA
AC CHARACTERISTICS						
Gain Bandwidth Product	GBW	$R_L=2k\Omega$ to $0V$, $f=100kHz$	-	3	-	MHz
Unity Gain Frequency	f_T	$R_L=2k\Omega$ to $0V$	-	3.2	-	MHz
Slew Rate	SR	$G_V=0dB$, $V_{in}=+2V$ to $+3V$, $R_L=2k\Omega$ to $0V$, $C_L=20pF$,	5	7	-	V/ μs
Phase Margin	ϕ_M	$R_L=2k\Omega$ to $0V$, $C_L=20pF$	-	64	-	deg
Gain Margin	G_M	$R_L=2k\Omega$ to $0V$, $C_L=20pF$	-	13	-	dB
NOISE, THD						
Equivalent Input Noise Voltage	e_n	$f=1kHz$	-	48	-	nV/ \sqrt{Hz}
Total Harmonic Distortion + Noise	THD+N	$G_V=6dB$, $f=1kHz$, $V_o=2V_{pp}$, $R_L=2k\Omega$ to $0V$, $C_L=20pF$	-	0.01	-	%
Channel Separation	CS	$f=1kHz$, Equivalent Input value	-	120	-	dB

ELECTRICAL CHARACTERISTICS

NJM3472 : Supply Current vs. Supply Voltage

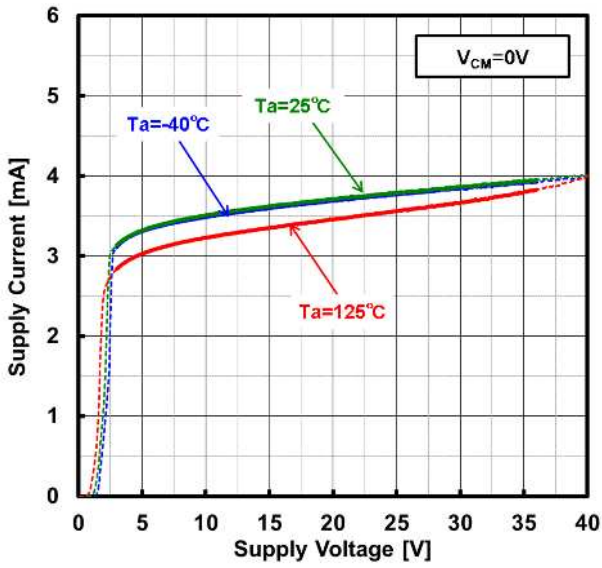

NJM3472 : Supply Current vs. Supply Voltage

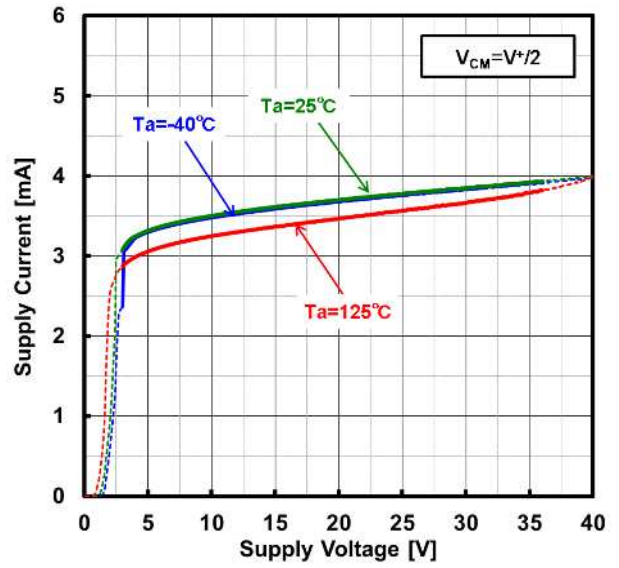

NJM3474 : Supply Current vs. Supply Voltage

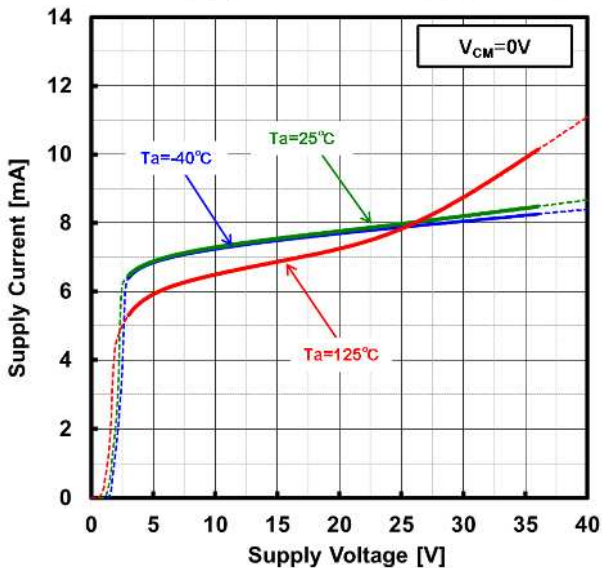

NJM3474 : Supply Current vs. Supply Voltage

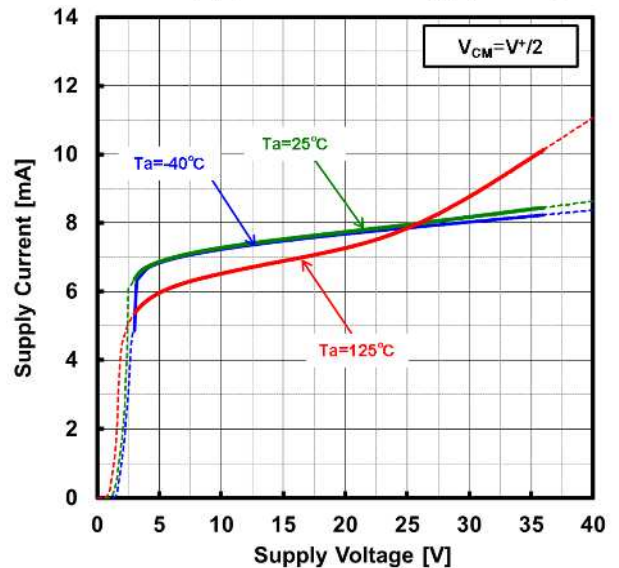

NJM3472 : Supply Current vs. Temperature

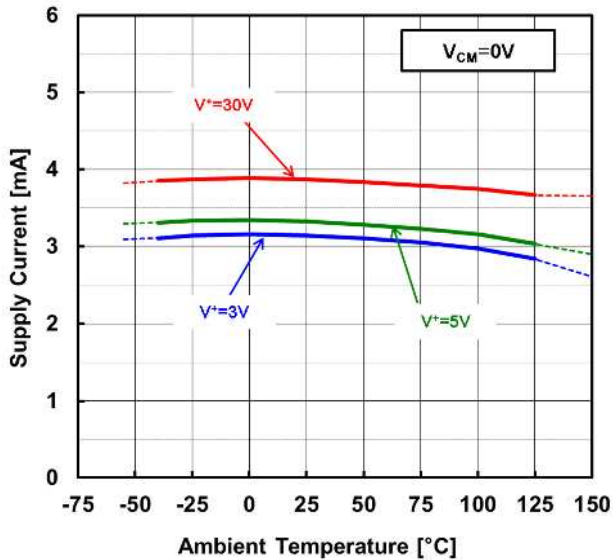

NJM3474 : Supply Current vs. Temperature

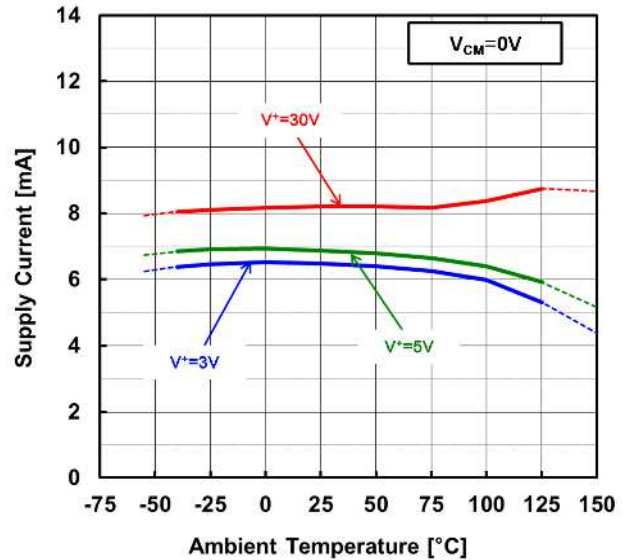

■ ELECTRICAL CHARACTERISTICS

Input Offset Voltage vs. Supply Voltage

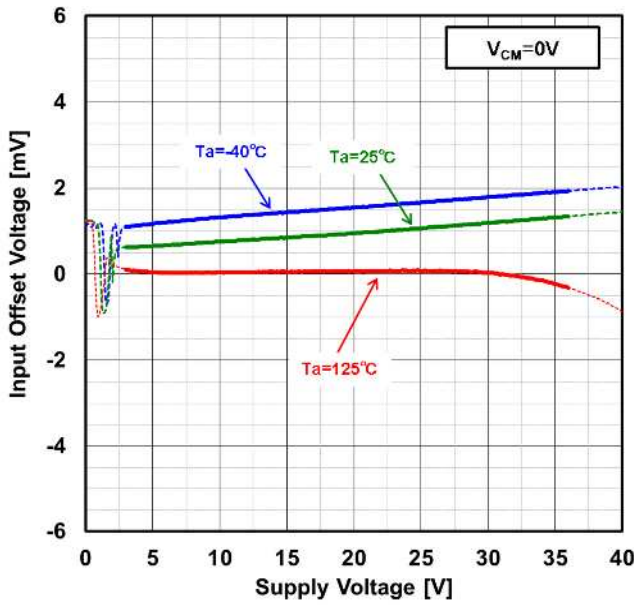

Input Offset Voltage vs. Supply Voltage

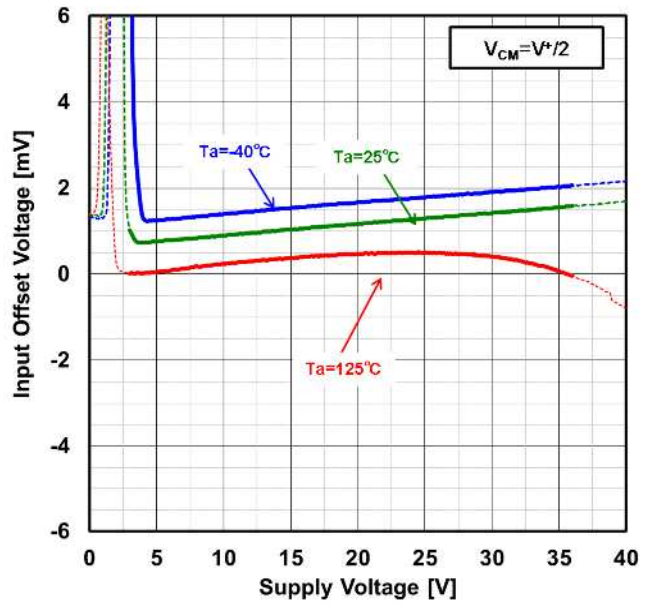

Input Offset Voltage vs. Ambient Temperature

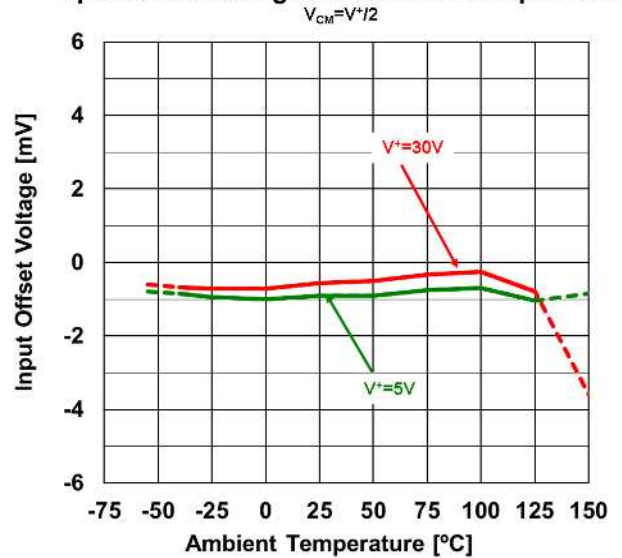

Input Offset Voltage vs. Common-Mode Input Voltage

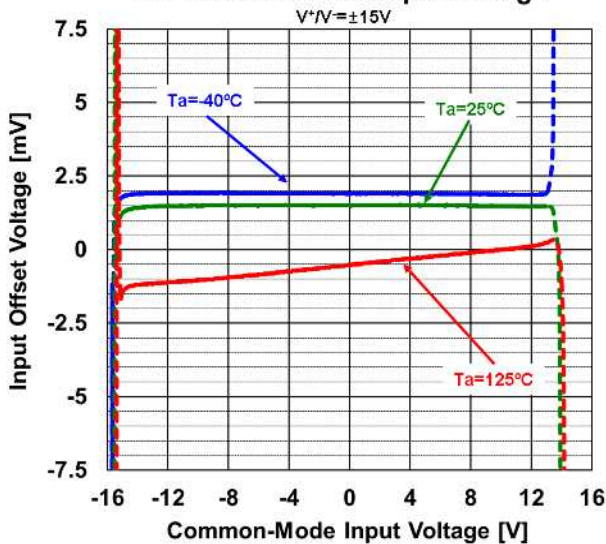

Input Offset Voltage vs. Common-Mode Input Voltage

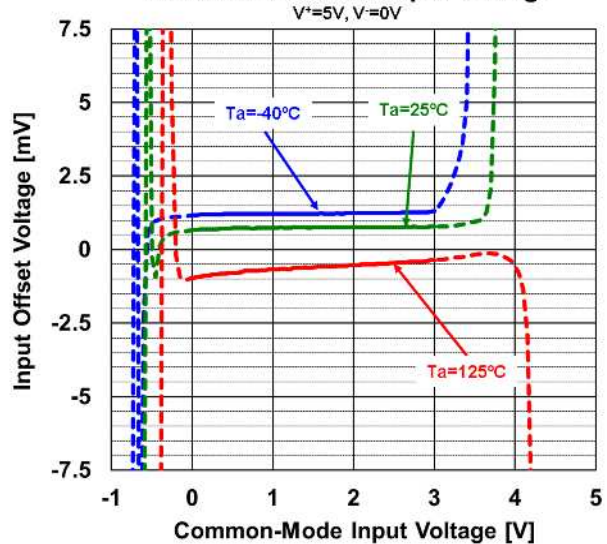

ELECTRICAL CHARACTERISTICS

Input Bias Current vs. Ambient Temperature

$$V_{CM} = V^*/2$$

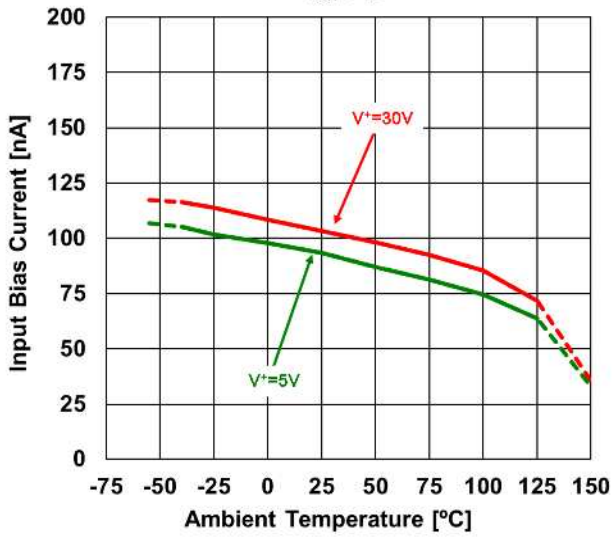

Input Offset Current vs. Ambient Temperature

$$V_{CM} = V^*/2$$

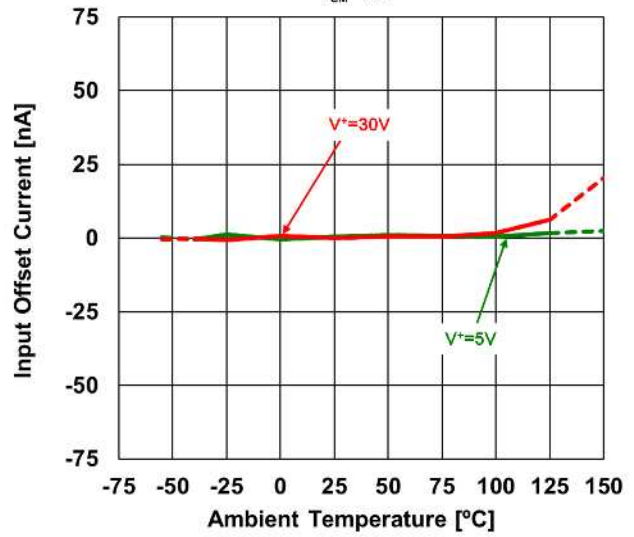

Common-Mode Rejection Ratio vs. Ambient Temperature

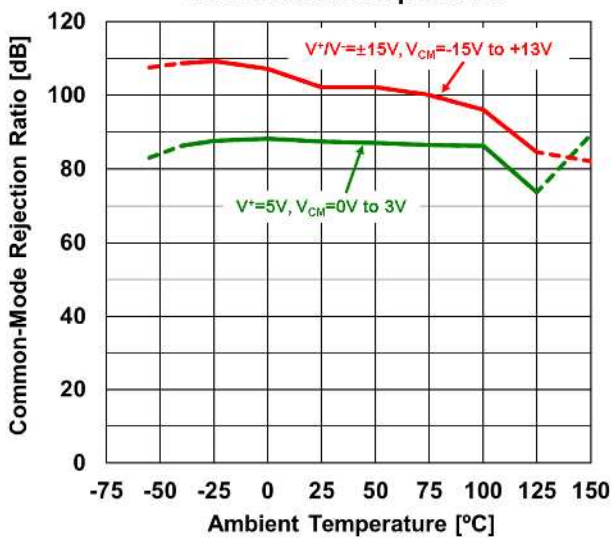

Supply Voltage Rejection Ratio vs. Ambient Temperature

$$V^*/V = \pm 2V \text{ to } \pm 18V, V_{CM} = V^*/2$$

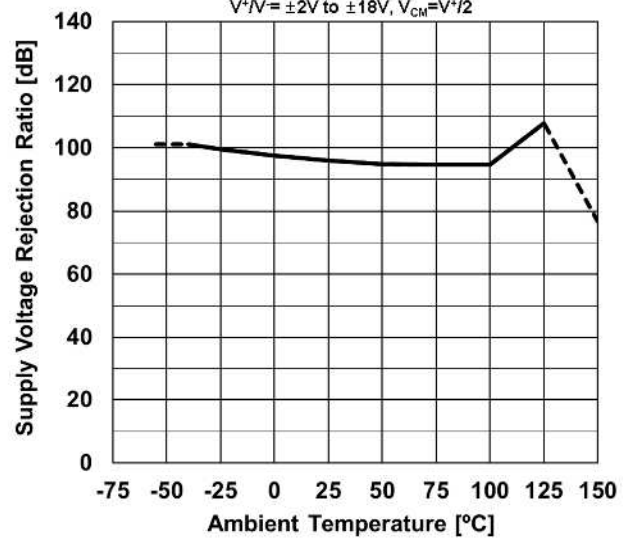

ELECTRICAL CHARACTERISTICS

High-Level / Low-Level Output Voltage vs. Ambient Temperature
 $V^+ / V^- = \pm 15V$

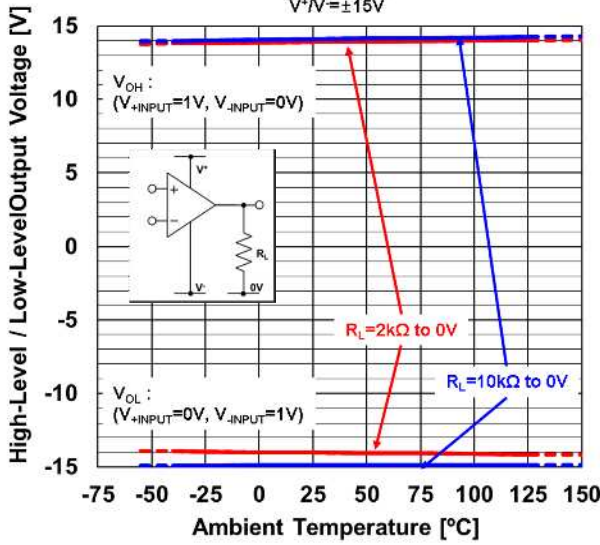

High-Level / Low-Level Output Voltage vs. Ambient Temperature
 $V^+ = 5V, V^- = 0V$

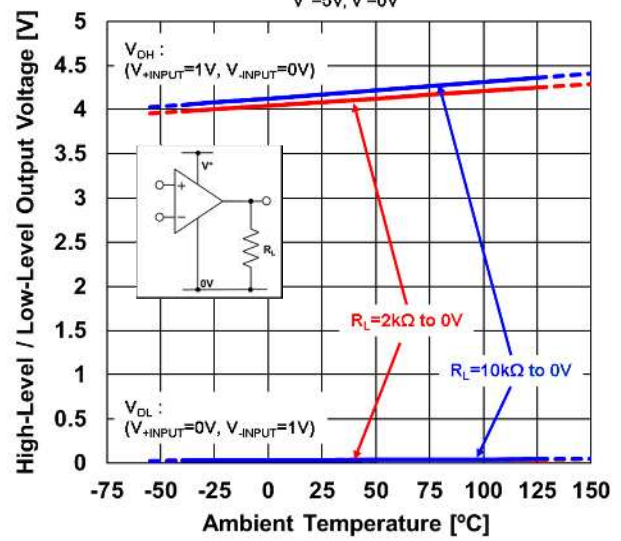

High-Level / Low-Level Output Voltage vs. Load Resistance
 $V^+ / V^- = \pm 15V, R_L$ to 0V

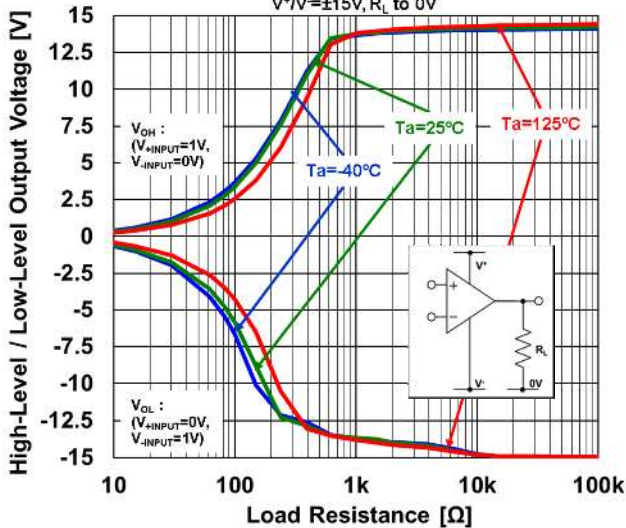

High-Level / Low-Level Output Voltage vs. Load Resistance
 $V^+ / V^- = \pm 2.5V, R_L$ to 0V

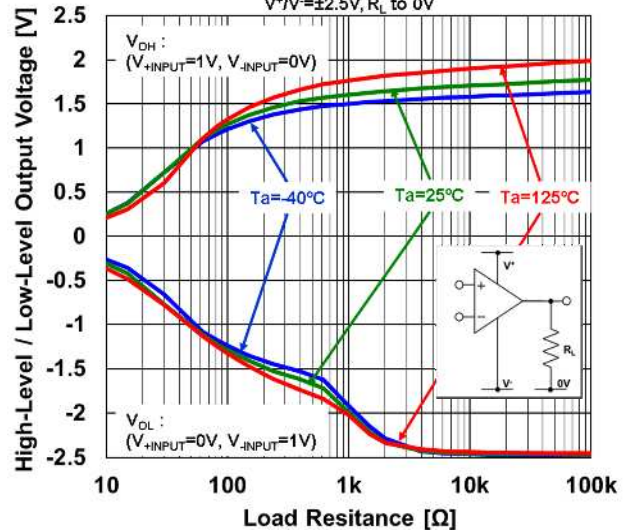

High-Level / Low-Level Output Voltage vs. Load Resistance
 $V^+ = 30V, R_L$ to 0V

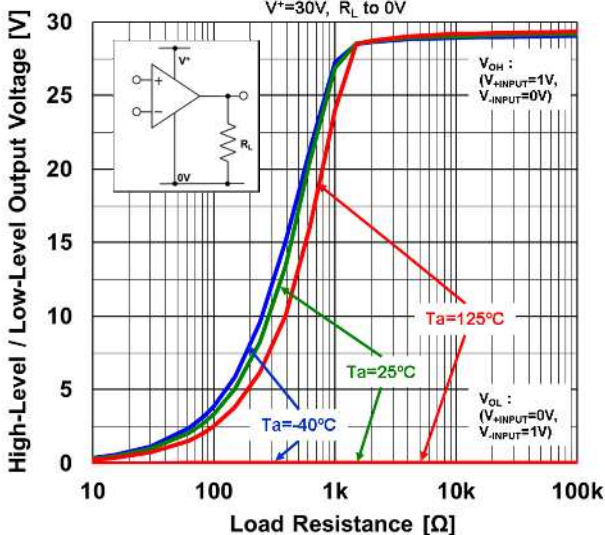

High-Level / Low-Level Output Voltage vs. Load Resistance
 $V^+ = 5V, R_L$ to 0V

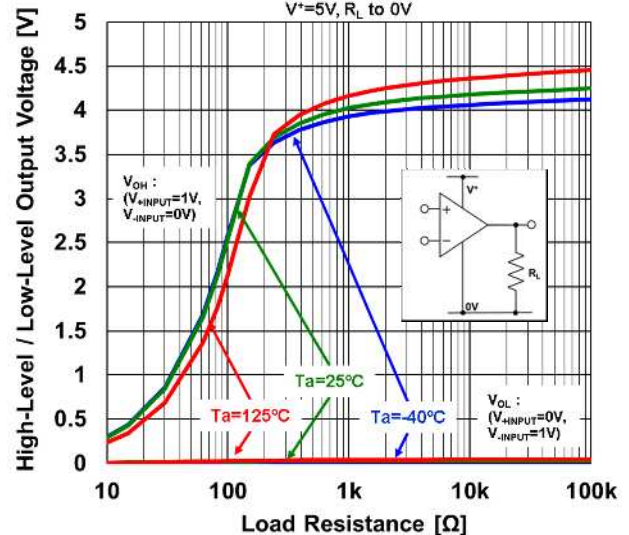

■ ELECTRICAL CHARACTERISTICS

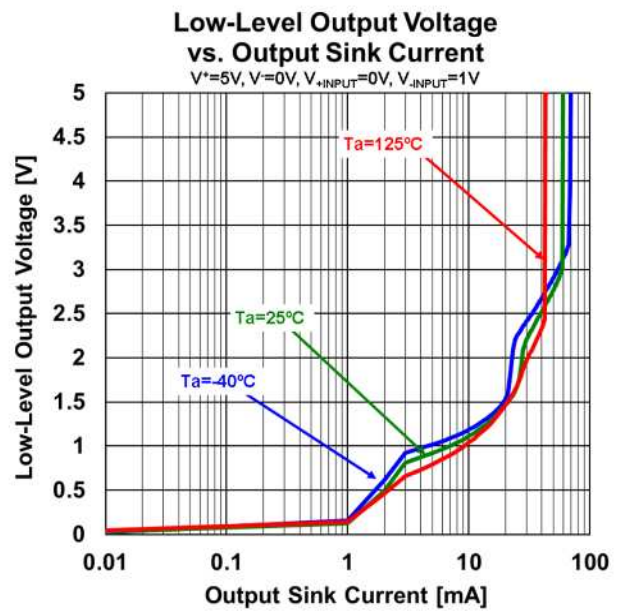
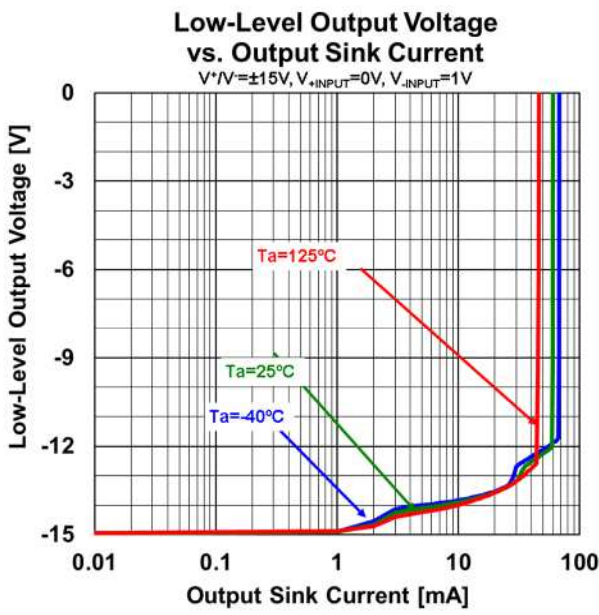
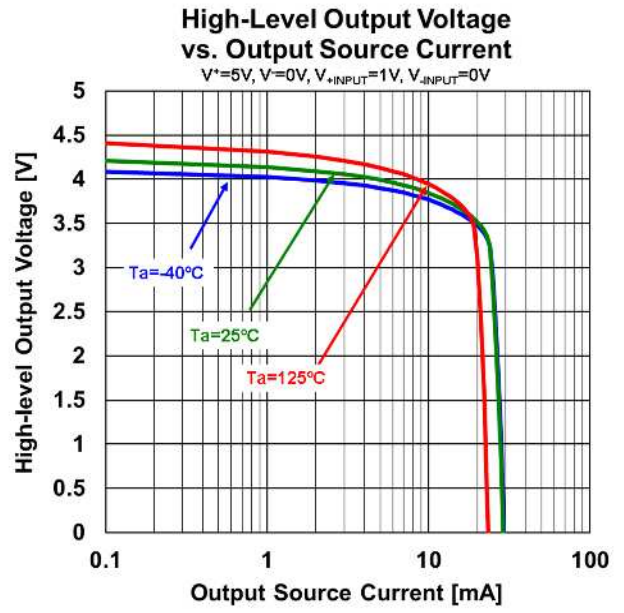
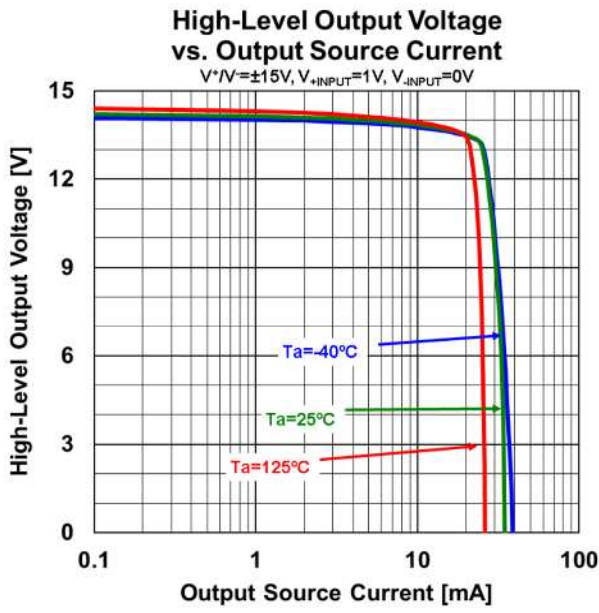

■ ELECTRICAL CHARACTERISTICS

Open-Loop Voltage Gain vs. Ambient Temperature

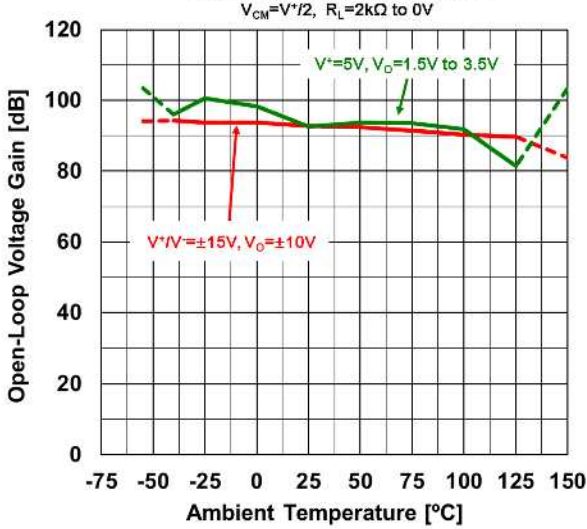

40dB Voltage Gain / Phase vs. Frequency

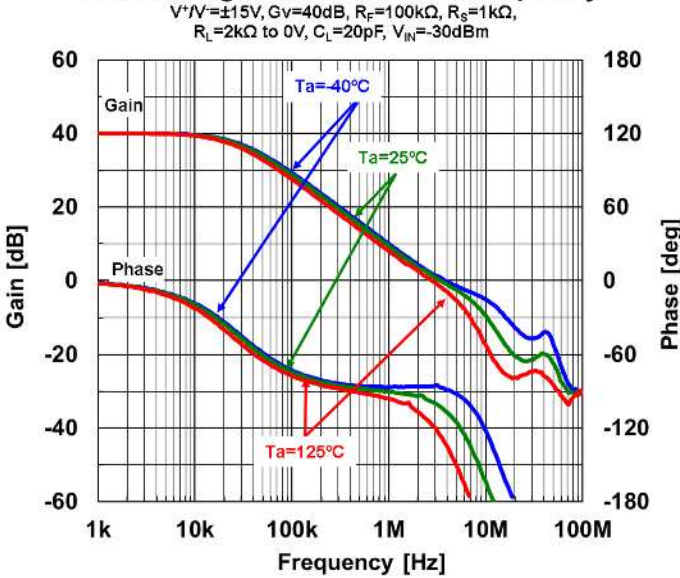

40dB Voltage Gain / Phase vs. Frequency

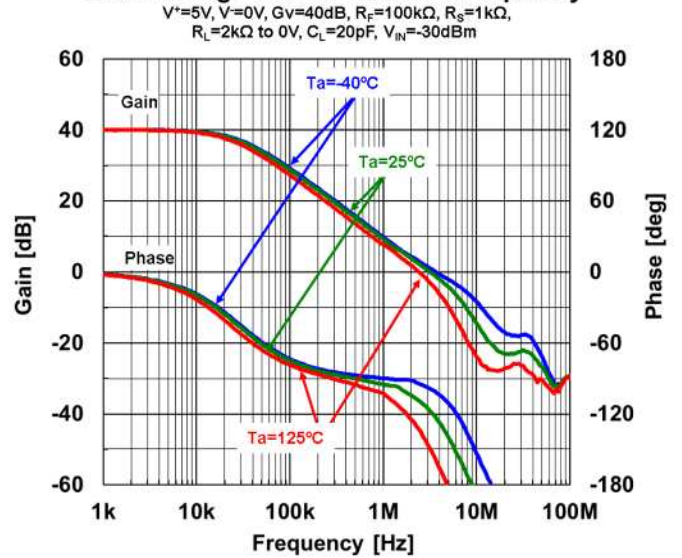

40dB Voltage Gain / Phase vs. Frequency

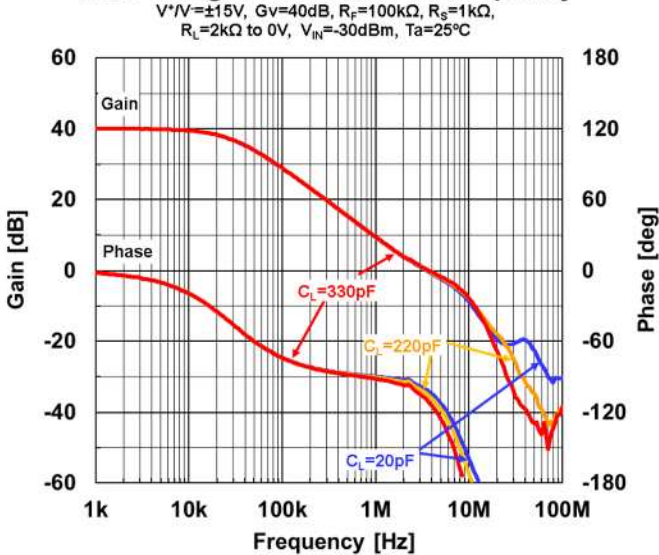

40dB Voltage Gain / Phase vs. Frequency

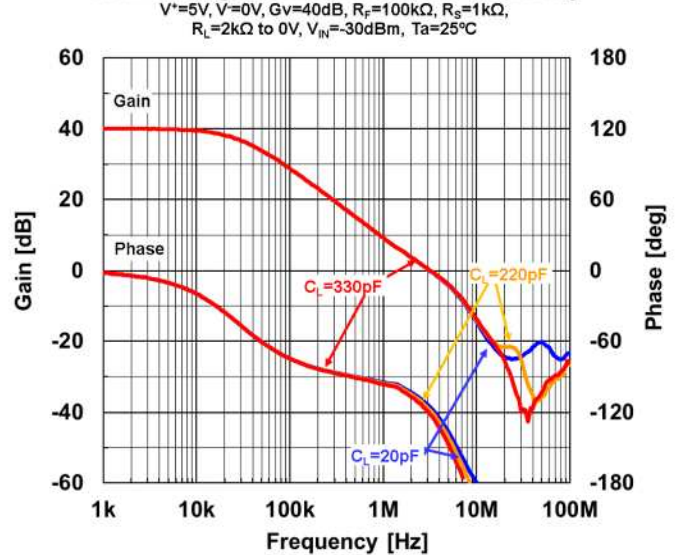

■ ELECTRICAL CHARACTERISTICS

Unity Gain Frequency / Gain Band Width vs. Ambient Temperature

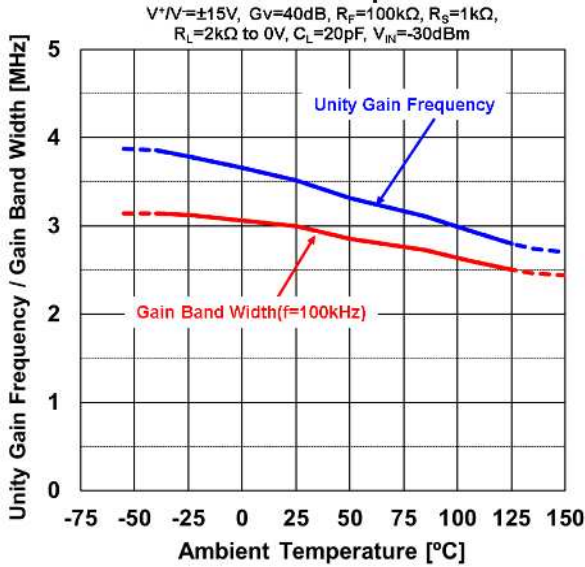

Unity Gain Frequency / Gain Band Width vs. Ambient Temperature

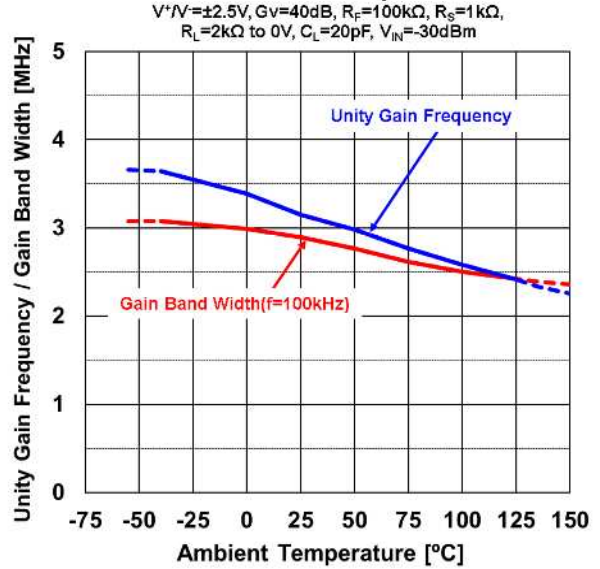

Phase Margin vs. Ambient Temperature

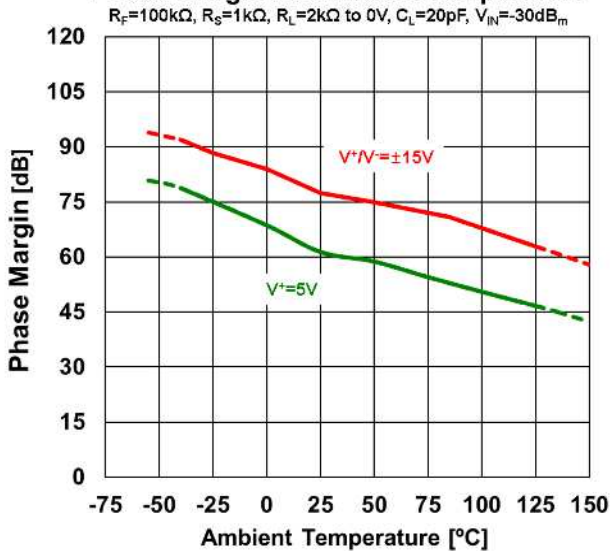

Gain Margin vs. Ambient Temperature

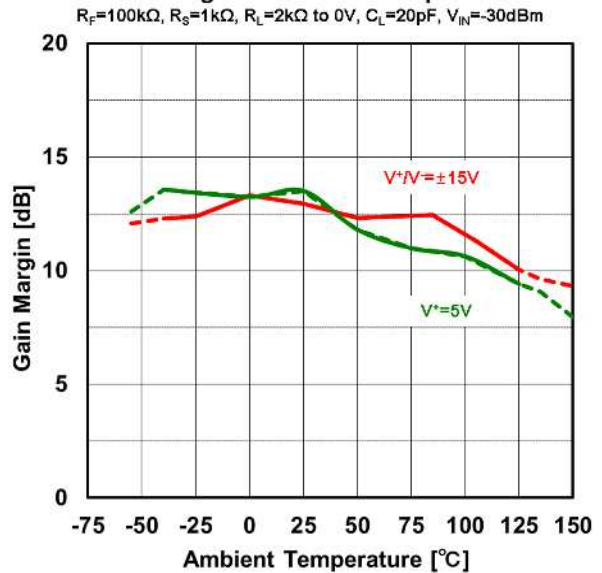

Slew Rate vs. Ambient Temperature

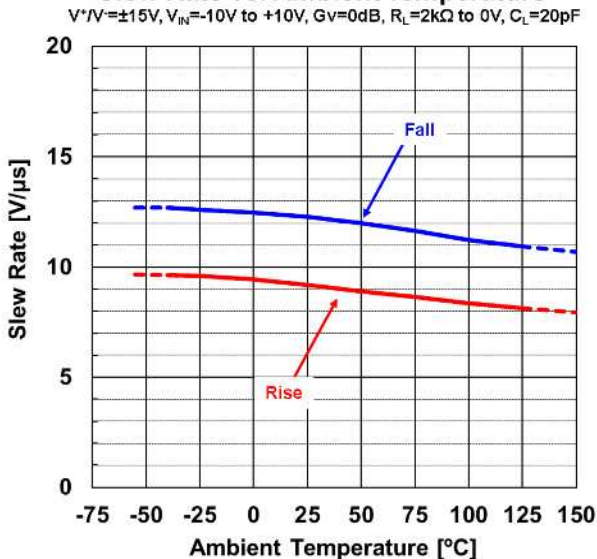

Slew Rate vs. Ambient Temperature

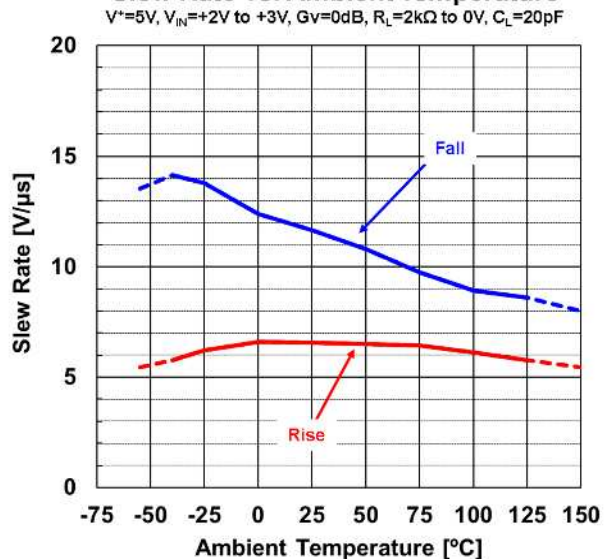

■ ELECTRICAL CHARACTERISTICS

Pulse Response

$V^+V^- = \pm 15V$, $V_{IN} = -10$ to $+10V$, $G_v = 0dB$, $R_L = 2k\Omega$ to $0V$, $C_L = 20pF$

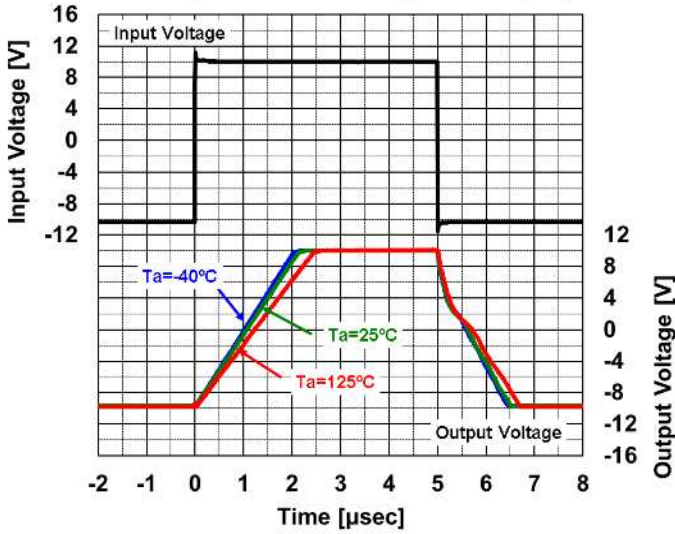

Pulse Response

$V^+ = 5V$, $V^- = 0V$, $V_{IN} = -0.5$ to $+0.5V$, $G_v = 0dB$, $R_L = 2k\Omega$ to $0V$, $C_L = 20pF$

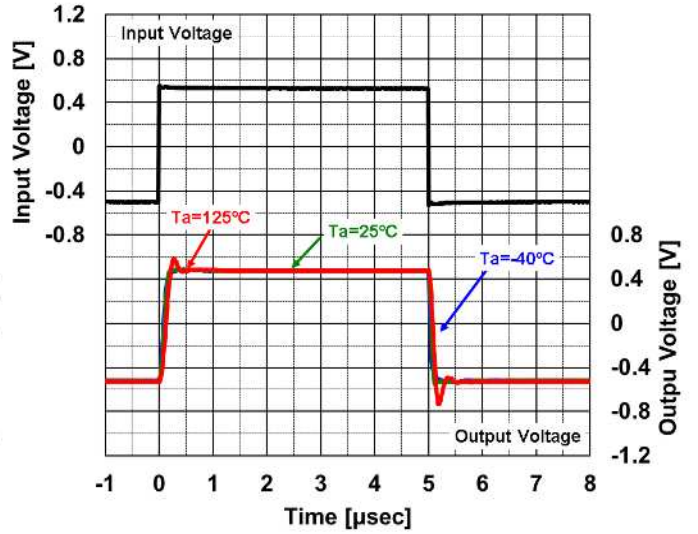

THD + N vs. Output Voltage

$V^+V^- = \pm 15V$, $G_v = 20dB$, $R_G = 200\Omega$, $R_F = 2k\Omega$, $R_S = 10k\Omega$, $T_a = 25^\circ C$, $BW = 10Hz$ to $500kHz$

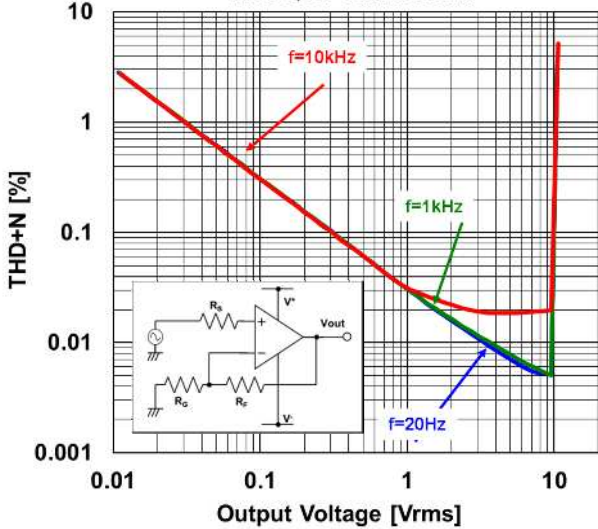

THD + N vs. Output Voltage

$V^+V^- = \pm 2.5V$, $G_v = 6dB$, $R_G = 1k\Omega$, $R_F = 1k\Omega$, $R_S = 10k\Omega$, $T_a = 25^\circ C$, $BW = 10Hz$ to $500kHz$

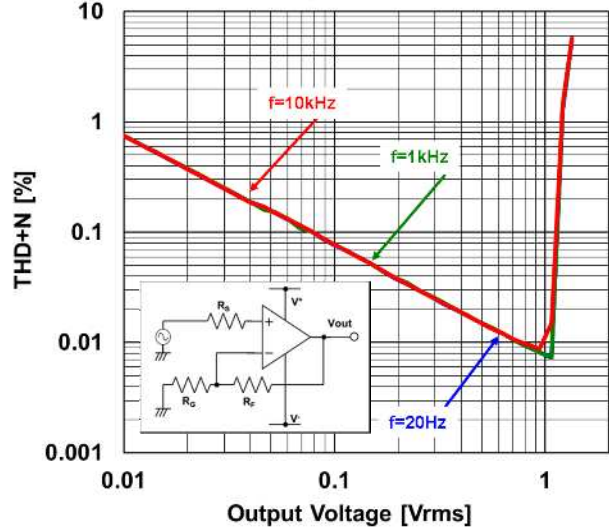

Voltage Noise Density vs. Frequency

$G_v = 40dB$, $R_S = 100\Omega$, $R_F = 10k\Omega$, $T_a = 25^\circ C$

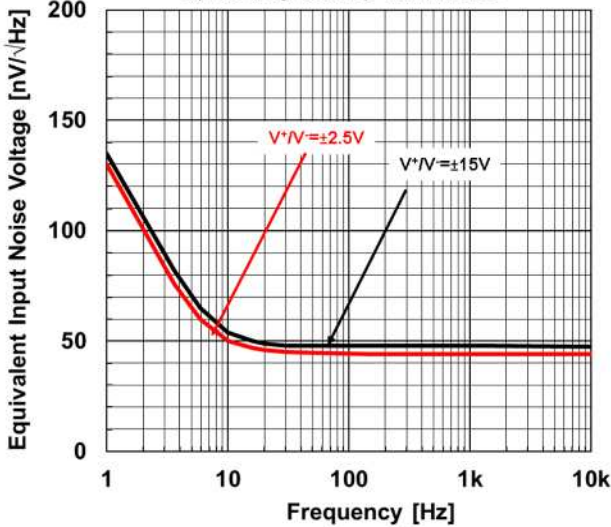

■ PACKAGE DIMENSIONS

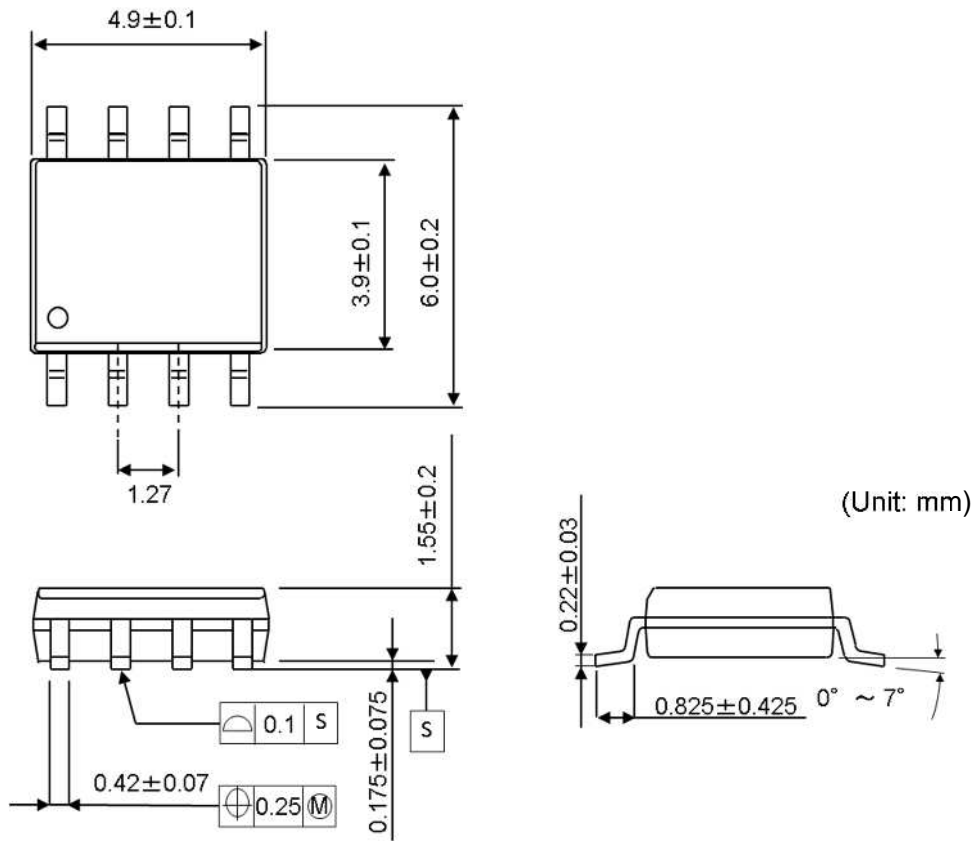

SOP8 Package

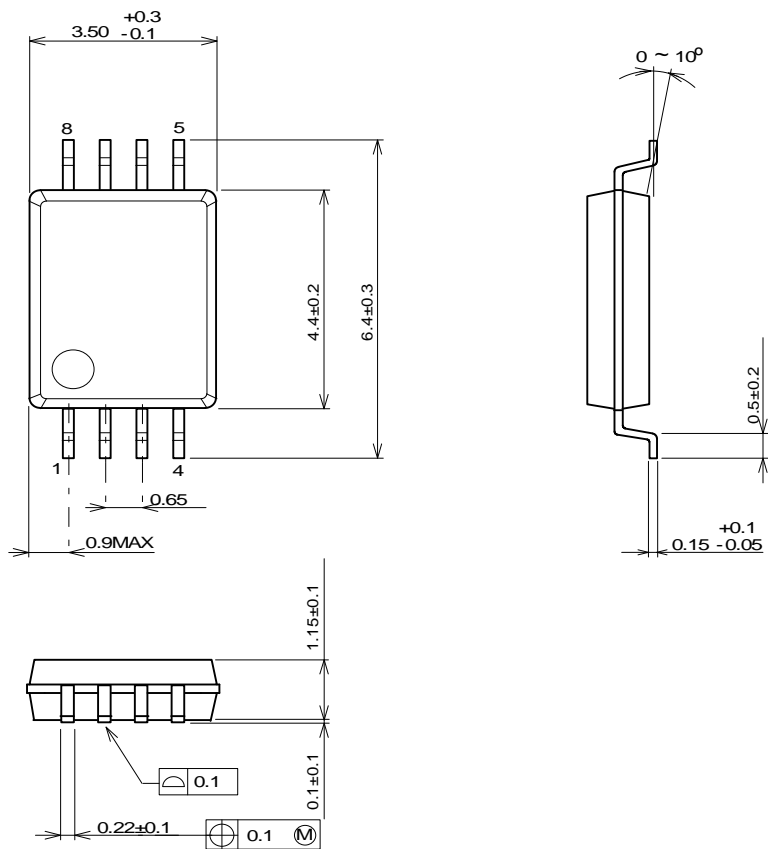

SSOP8 Package

■ PACKAGE DIMENSIONS

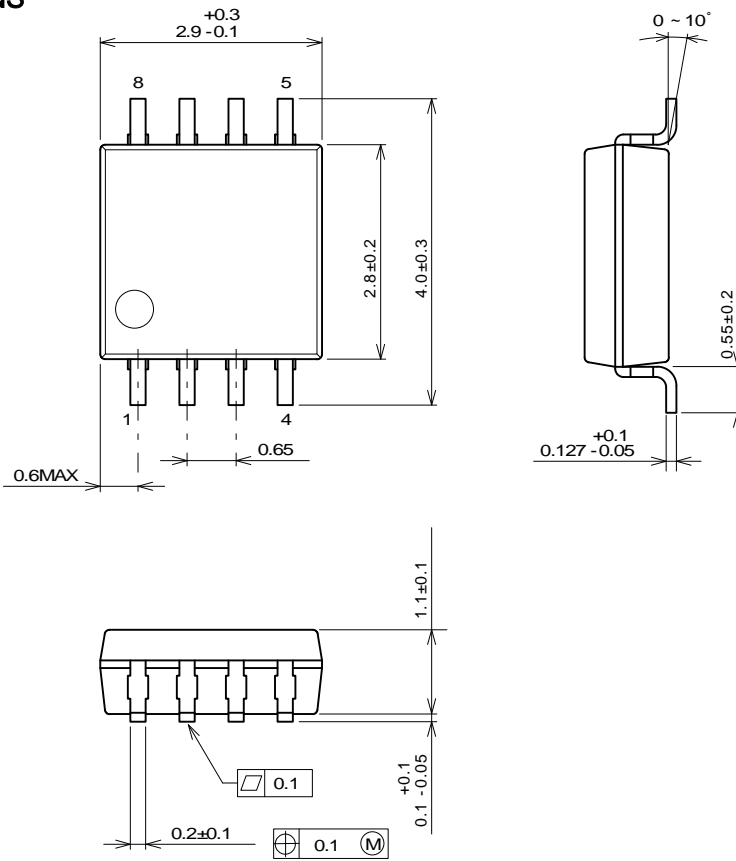

MSOP8 (VSP8) JEDEC MO-187-DA / thin type Package

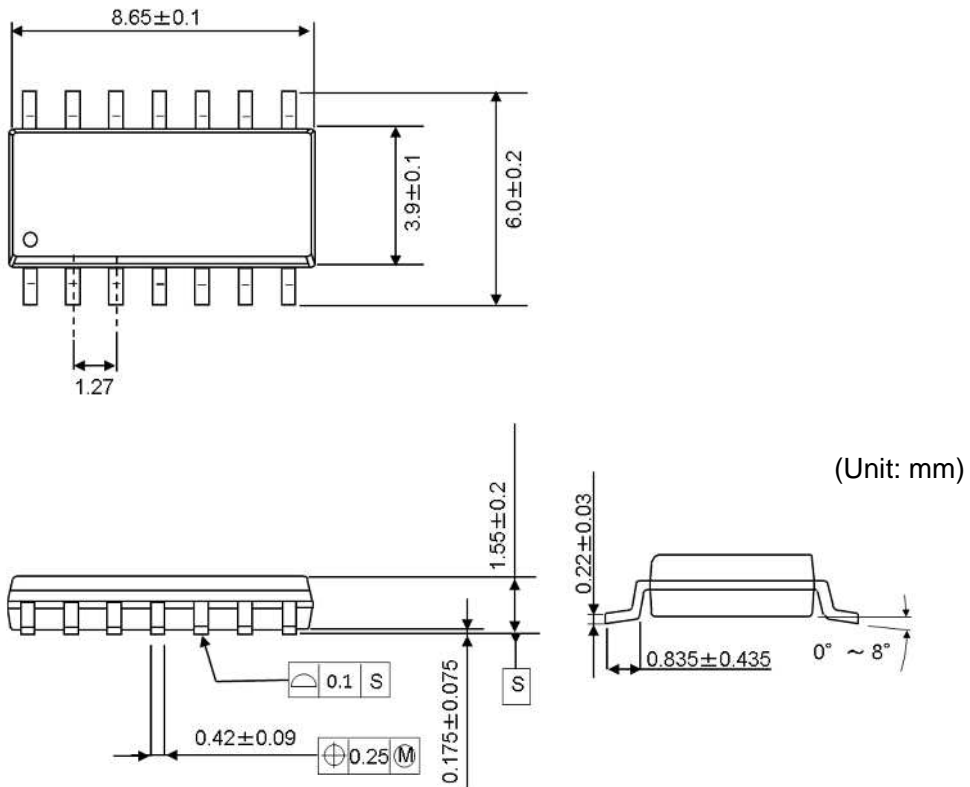

SOP14 Package

■PACKAGE DIMENSIONS

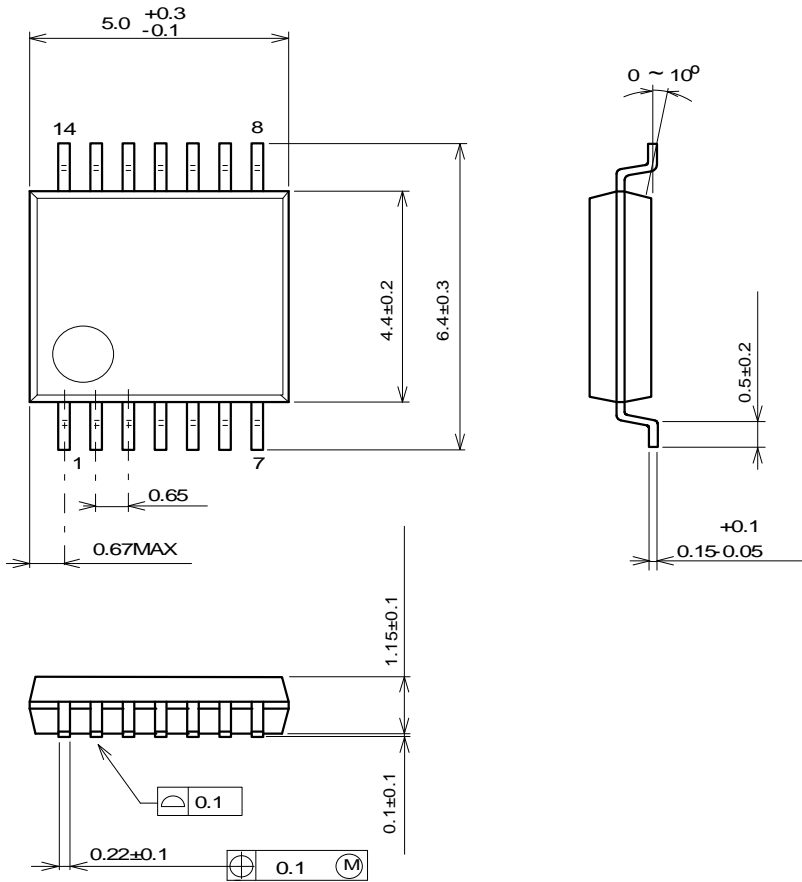

(Unit: mm)

SSOP14 Package

[CAUTION]
 The specifications on this data book are only given for information, without any guarantee as regards either mistakes or omissions. The application circuits in this data book are described only to show representative usages of the product and not intended for the guarantee or permission of any right including the industrial rights.