

REVISIONS

P	LTR	DESCRIPTION	DATE	DWN	APVD
	NC	NEW RELEASE PER E.O. P15506	23DEC1997	DM	RDR
	A	RELEASED PER E.O. P15996	25MAY1999	DM	RDR
	B	RELEASED PER PCN E-18-001206	24JAN2018	JA	DM
	B1	REVISED PER PCN E-19-018080	21NOV2019	MK	DM

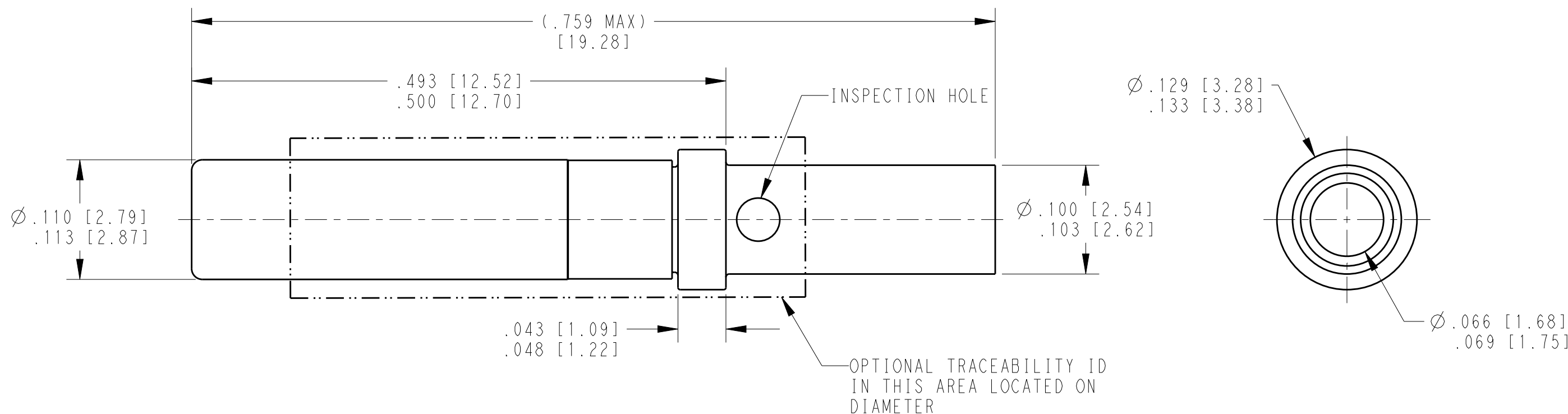

TE INTERNAL PN	DEUTSCH PN	PLATING
0462-201-1631	0462-201-1631	GOLD
0462-201-16141	0462-201-16141	NICKEL

THIS DRAWING IS A CONTROLLED DOCUMENT.		DWN D. MEYER 17DEC1997	STE TE Connectivity	
DIMENSIONS: INCHES [mm]		CHK V. TOMSA 25MAY1999		
TOLERANCES UNLESS OTHERWISE SPECIFIED:		APVD R. REED 25MAY1999	NAME CONTACT SOCKET SIZE 16	
0 PLC \pm		PRODUCT SPEC 108-151004	SIZE A3	
1 PLC \pm		APPLICATION SPEC 114-151004	CAGE CODE 4AFU8	DRAWING NO 0462-201-16XX
2 PLC \pm		WEIGHT 0.60g	RESTRICTED TO -	
3 PLC \pm		CUSTOMER DRAWING	SCALE 10:1	SHEET 1 OF 1
4 PLC \pm			REV B1	
ANGLES \pm				
FINISH				

NOTES:
1. SEE APPLICATION SPECIFICATION 114-151004 FOR CRIMP TOOLS AND WIRE RANGE.

Mouser Electronics

Authorized Distributor

Click to View Pricing, Inventory, Delivery & Lifecycle Information:

[TE Connectivity:](#)

[0462-201-1631](#)