

Data Sheet | Item Number: 770-103

Socket; with strain relief housing; 3-pole; Cod. A; 4,00 mm²; black



<https://www.wago.com/770-103>



Color: ■ black

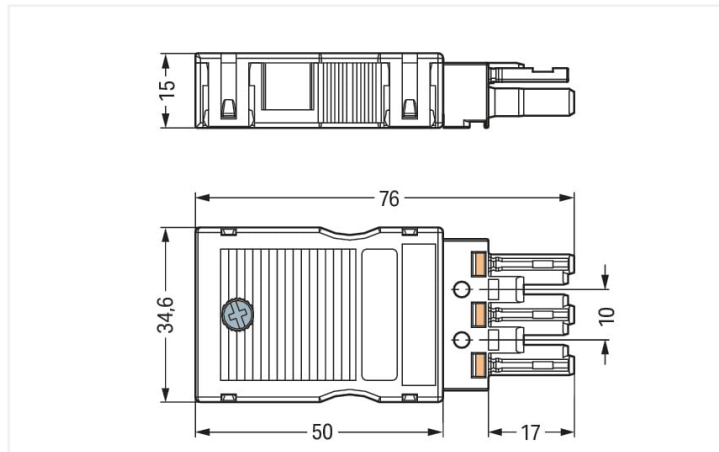

Dimensions in mm

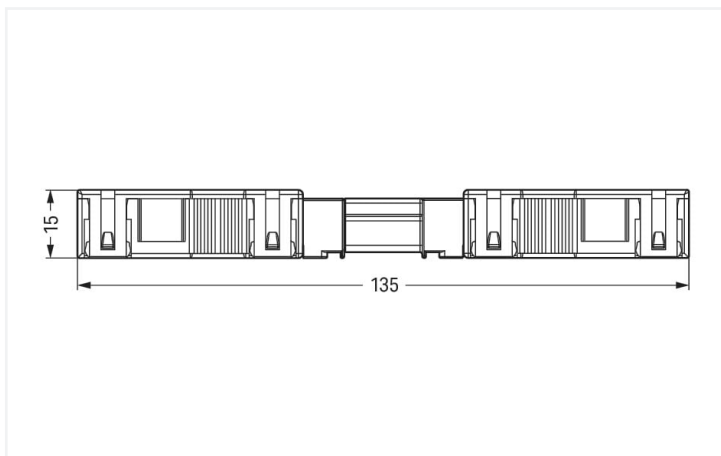

Dimensions in mm

Overall length when mated

Female connector/socket WINSTA® MIDI with strain relief

The WINSTA® MIDI female connector/socket rated current 25 A provides the foundation for assembly of fine-stranded and solid conductors. WAGO pluggable installation connectors are useful when criteria repeat or are planned on a defined pattern, for example for installing grid lighting or flush-mount lighting. The mechanical coding and color coding of the pluggable installation connector ensure error-free installation of the individual components – including protection against mismatching. Thanks to the color coding and mechanical A coding of WINSTA® MIDI pluggable installation connectors, you can clearly distinguish different circuits. This pluggable installation connector is used for electrical currents up to 25 A. Thus the product is especially suitable for high power loads. WINSTA® MIDI with Push-in CAGE CLAMP® spring pressure connection technology is found in a broad range of individual products you can use for quick, easy, flexible, and secure installation. A range up to 55 mm can be used for the strip length.

Lower costs through fast commissioning and elimination of service expenses – solutions from WINSTA® MIDI

WINSTA® is the pluggable connection system that is ideally tailored to the strict requirements of electrical installation. It allows error-free installation of cables and components, quickly and reliably. Choose durability and quality – the WINSTA® MIDI pluggable installation connector with marking from WAGO makes the installation of electrical components significantly easier.

- protection against mismatching eliminates errors
- for automation controllers
- for any mains application
- flexible installation to save space
- convenient installation and commissioning

This item includes:



Item No.: 770-503

1

Item No.: 770-203

1

Strain relief housing; 3-pole; for 2 cables;
8.0 ... 11.5 mm; 55 mm; blackSocket; 3-pole; Cod. A; 4,00 mm²; black

Electrical data

Ratings per IEC/EN

Ratings per	IEC/EN 60664-1
Nominal voltage (III/3)	250 V
Rated impulse voltage (III/3)	4 kV
Rated current	25 A
Legend (ratings)	(III / 3) ≙ Overvoltage category III / Pollution degree 3

Ratings per UL 1977

Note for the US market	Some versions may also be used for current interruption in accordance with the UL certificate in select applications with currents below 16 A and voltages up to 600 V. For further information, please contact your local sales office.
Rated voltage (UL 1977)	600 V
Rated current UL 1977	23 A

General

Note on contact resistance	approx. 1 mΩ of contact resistance approx. 0.25 mΩ contact transition plug/ socket
----------------------------	--

Connection data

Connection points	6
Total number of potentials	3
Number of test slots	3

Connection 1

Connection technology	Push-in CAGE CLAMP®
Actuation type	Operating tool Push-in
Nominal cross-section	4 mm ² / 12 AWG
Solid conductor	0.5 ... 4 mm ² / 20 ... 12 AWG
Solid conductor; push-in termination	1.5 ... 4 mm ² / 16 ... 12 AWG
Stranded conductor	0.5 ... 2.5 mm ² / 20 ... 14 AWG
Fine-stranded conductor	0.5 ... 4 mm ² / 20 ... 12 AWG
Fine-stranded conductor; with insulated ferrule	0.25 ... 1.5 mm ² / 20 ... 16 AWG
Fine-stranded conductor; with uninsulated ferrule	0.25 ... 2.5 mm ² / 20 ... 14 AWG
Fine-stranded conductor; with ferrule; push-in termination	1.5 mm ² / 16 AWG
Strip length	9 mm / 0.35 inches
Pole number	3
Connectable sheathed cable diameter	8 ... 11.5 mm
Conductor entry direction to mating direction	0°
Strip length (outer insulation)	55 mm

Physical data

Pin spacing	10 mm / 0.394 inches
Width	34.6 mm / 1.362 inches
Height	15 mm / 0.591 inches
Depth	75.9 mm / 2.988 inches

Mechanical data

Application	General mains applications
Coding	A
Variable coding	Yes
Marking	L ⊕ N
Potential marking	L ⊕ N
Mating force of a plug-in connection	approx. 20 ... 70 N (depending on pole number)
Retention force of a plug-in connection	Locked: > 80 N
Unmating force of a plug-in connection	Unlocked: approx. 20 ... 70 N (depending on pole number)
Number of mating cycles	200, without resistive load
Protection type	IP2XC; When mated and secured with a strain relief housing: IP2xC (These compact connectors are not designed for use in open, easily accessible areas!)

Plug-in connection

Contact type (pluggable connector)	Female connector/socket
Connector (connection type)	for conductor
Mismating protection	Yes
Note on mismating protection	All <i>WINSTA</i> ® components are 100% protected against mismating when: a.) plugging different numbers of poles b.) plugging while rotated 180 c.) plugging while laterally staggered d.) plugging one pole
Locking lever	Can be retrofitted
Locking of plug-in connection	Locking lever
Note on locking system	All connectors for mounted installations (snap-in versions for lighting fixtures or devices, all types of PCB and distribution connectors) are factory-equipped with locking levers to ensure plugs and sockets are securely locked. Additional locking levers are only required for flying leads (plug/socket).
Strain relief	Strain relief housing

Material data

Note (material data)	Information on material specifications can be found here
Color	black
Cover color	gray
Material group	I
Insulation material	Polyamide (PA66)
Flammability class per UL94	V0
Clamping spring material	Chrome-nickel spring steel (CrNi)
Contact material	Copper or copper alloy; surface-treated
Contact plating	Tin
Fire load	0.429 MJ
Strain relief color	black
Weight	20 g

Environmental requirements

Processing temperature	-5 ... +40 °C
Continuous operating temperature	-35 ... +85 °C
Note on continuous operating temperature	Insulating parts for temperatures ≤ 105 °C

Commercial data

Product Group	20 (Winsta)
eCl@ss 10.0	27-44-06-05
eCl@ss 9.0	27-44-06-05
ETIM 8.0	EC002560
ETIM 7.0	EC002560
PU (SPU)	25 pcs
Packaging type	Box
Country of origin	DE
GTIN	4044918252096
Customs tariff number	85366990990

Approvals / Certificates

General approvals



Approval	Standard	Certificate Name
CCA DEKRA Certification B.V.	EN 61535	71-123228
CCA DEKRA Certification B.V.	IEC 61535	NL -84761
cURus Underwriters Laboratories Inc.	UL 1977	E45171
VDE VDE Prüf- und Zertifizie- rungsinstitut	EN 61984	40002889
VDE VDE Prüf- und Zertifizie- rungsinstitut	EN 61535	40029808

Declarations of conformity and manufacturer's declarations

Approval	Standard	Certificate Name
EU-Declaration of Confor- mity WAGO GmbH & Co. KG	-	-

Approvals for marine applications



Approval	Standard	Certificate Name
ABS American Bureau of Ship- ping	-	19-HG1868589-PDA
DNV GL Det Norske Veritas, Ger- manischer Lloyd	-	TAE00001Z6
LR Lloyds Register	IEC 61984	LR22429487TA

Downloads

Environmental Product Compliance

Compliance Search	
Environmental Product Compliance 770-103	↓

Documentation

Bid Text			
770-103	19.02.2019	xml 3.01 KB	↓
770-103	08.06.2015	doc 23.50 KB	↓
ausschreiben.de 770-103			↓

CAD/CAE-Data

CAD data	
2D/3D Models 770-103	↓

CAE data	
EPLAN Data Portal 770-103	↓

WSCAD Universe 770-103	↓
---------------------------	---

ZUKEN Portal 770-103	↓
----------------------	---

1 Compatible Products

1.1 System counterpart

1.1.1 Cable assembly



Item No.: 771-9993/206-101
pre-assembled connecting cable; Eca; Plug/open-ended; 3-pole; Cod. A; H05VV-F 3G 1.5 mm²; 1 m; 1,50 mm²; black

Item No.: 771-9993/006-101
pre-assembled interconnecting cable; Eca; Socket/plug; 3-pole; Cod. A; H05VV-F 3G 1.5 mm²; 1 m; 1,50 mm²; black

1.1.2 Distribution box



Item No.: 899-631/181-000
Distribution box; 230 V + DALI; 2 inputs; 6 outputs; Cod. A, I; MINI, MIDI; black



Item No.: 899-631/405-000
Distribution box; 230 V + SM; 2 inputs; 6 outputs; Cod. A, B; MINI, MIDI; black



Item No.: 899-631/315-000
Distribution box; Cable and device protection; 1 input; 4 outputs; Cod. A; MIDI; black



Item No.: 899-631/305-000
Distribution box; Crossover switching; 1 input; 5 outputs; Cod. A, B, S; MIDI; black



Item No.: 899-631/309-000
Distribution box; Motion/presence detector; 1 input; 3 outputs; Cod. A, S; MIDI; black



Item No.: 899-631/180-000
Distribution box; Motion/presence detector; 1 input; 5 outputs; Cod. A; MIDI; black



Item No.: 899-632/102-000
Distribution box; Relay switching; 2 inputs; 1 output; Cod. A, B; MINI, MIDI



Item No.: 899-631/386-000
Distribution box; Series switching; 1 input; 7 outputs; Cod. A, S; MIDI; black



Item No.: 899-631/477-000
Distribution box; Single-phase current (230 V); 1 input; 11 outputs; Cod. A; MIDI



Item No.: 899-631/334-000
Distribution box; Single-phase current (230 V); 1 input; 13 outputs; Cod. A; MIDI; black



Item No.: 899-631/476-000
Distribution box; Single-phase current (230 V); 1 input; 4 outputs; Cod. A; MIDI



Item No.: 899-631/104-000
Distribution box; Single-phase current (230 V); 1 input; 7 outputs; Cod. A; MIDI; black

1.1.2 Distribution box



Item No.: 899-631/311-000
Distribution box; Single-phase current (230 V); 2 inputs; 6 outputs; Cod. A, P; MIDI; black



Item No.: 899-631/327-000
Distribution box; Single-phase current (230 V); 2 inputs; 6 outputs; Cod. A; MIDI; black



Item No.: 899-631/363-000
Distribution box; Single-pole switch circuit; 1 input; 5 outputs; Cod. A, S; MIDI; black



Item No.: 899-631/478-000
Distribution box; Single-pole switch circuit; 1 input; 7 outputs; Cod. A, S; MIDI



Item No.: 899-632/101-000
Distribution box; Surge switch circuit; 1 input; 4 outputs; Cod. A, S; MIDI; black



Item No.: 899-632/138-000
Distribution box; Surge switch circuit; 1 input; 4 outputs; Cod. A, S; MIDI; black



Item No.: 899-632/103-000
Distribution box; Surge switch circuit; 2 inputs; 2 outputs; Cod. A; MIDI



Item No.: 899-631/308-000
Distribution box; Two-way circuit; 1 input; 5 outputs; Cod. A, S; MIDI; black



Item No.: 899-631/189-000
Distribution box; Two-way circuit; 1 input; 7 outputs; Cod. A, S; MIDI; black

1.1.3 Distribution connector



Item No.: 770-607
3-way distribution connector; 3-pole; Cod. A; 1 input; 3 outputs; black



Item No.: 770-608
5-way distribution connector; 3-pole; Cod. A; 1 input; 5 outputs; outputs on both sides; black



Item No.: 770-638
Distribution connector for switches; Single-pole and throttle two-way circuit; 3-pole; Cod. A/S; 1 input; 5 outputs; black



Item No.: 770-637
Distribution connector for switches; Single-pole switch and series circuit; 3-pole; Cod. A/S; 1 input; 5 outputs; black



Item No.: 770-633
h-distribution connector; 3-pole; Cod. A; 1 input; 2 outputs; 2 locking levers; black



Item No.: 770-635
h-distribution connector; 3-pole; Cod. A; 1 input; 2 outputs; outputs on both sides; 3 locking levers; for flying leads; black



Item No.: 770-634
h-distribution connector; 3-pole; Cod. A; 1 input; 2 outputs; outputs on one side; 2 locking levers; black



Item No.: 770-636
h-distribution connector; 3-pole; Cod. A; 1 input; 2 outputs; outputs on one side; 3 locking levers; for flying leads; black



Item No.: 770-606
T-distribution connector; 3-pole; Cod. A; 1 input; 2 outputs; 2 locking levers; black



Item No.: 770-615
T-distribution connector; 3-pole; Cod. A; 1 input; 2 outputs; 3 locking levers; for flying leads; black

1.1.4 Male connector/plug



Item No.: 770-813/011-000
Plug for PCBs; angled; 3-pole; Cod. A; black



Item No.: 770-813
Plug for PCBs; straight; 3-pole; Cod. A; black



Item No.: 770-213
Plug; 3-pole; Cod. A; 4,00 mm²; black



Item No.: 770-213/002-000
Plug; with direct ground contact; 3-pole; Cod. A; 4,00 mm²; black



Item No.: 770-113
Plug; with strain relief housing; 3-pole; Cod. A; 4,00 mm²; black



Item No.: 770-213/035-000
Plug; with strain relief housing; 3-pole; Cod. A; 4,00 mm²; black



Item No.: 770-713
Snap-in plug; 3-pole; Cod. A; 4,00 mm²; black



Item No.: 770-713/007-000
Snap-in plug; with direct ground contact; 3-pole; Cod. A; 4,00 mm²; black

1.2 Required Accessories

1.2.1 Locking system

1.2.1.1 Locking system



Item No.: 770-101

Locking lever; for flying leads; for manual operation; black

Item No.: 770-121

Locking lever; for flying leads; for manual operation; white

Item No.: 770-111

Locking lever; for flying leads; for tool operation; black

Item No.: 770-131

Locking lever; for flying leads; for tool operation; white

1.3 Optional Accessories

1.3.1 Cover

1.3.1.1 Cover



Item No.: 770-201

Lockout cap; 12-pole, separable; for sockets; Plastic; black

Item No.: 770-221

Lockout cap; 12-pole, separable; for sockets; Plastic; white

1.3.2 Marking

1.3.2.1 Marker



Item No.: 770-450/000-006

Marker card; Plastic; blue

Item No.: 770-450/000-001

Marker card; Plastic; green

Item No.: 770-450/000-012

Marker card; Plastic; orange

Item No.: 770-450/000-005

Marker card; Plastic; red



Item No.: 770-450

Marker card; Plastic; white

Item No.: 770-450/000-002

Marker card; Plastic; yellow

1.3.3 Tool

1.3.3.1 Operating tool



Item No.: 770-383

Operating tool; 3-way; green

Item No.: 210-719

Operating tool; Blade: 2.5 x 0.4 mm; with a partially insulated shaft

Installation Notes

Conductor termination

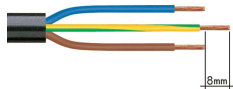

1. Strip length, outer insulation = 35 mm (2-pole), 55 mm (3- to 5-pole)
2. Strip length = 9 mm
3. Extended ground conductor = 8 mm

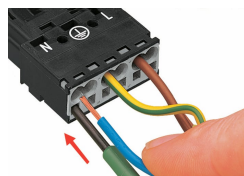

To terminate fine-stranded conductors, open the clamping unit via screwdriver (2.5 mm blade width) and insert a stripped conductor until it hits the backstop.



Insert the stripped solid conductor until it hits the backstop.

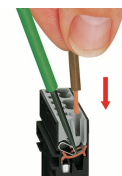

To terminate fine-stranded conductors, open the clamping unit via screwdriver (2.5 mm blade width) and insert a stripped conductor until it hits the backstop.

Conductor removal

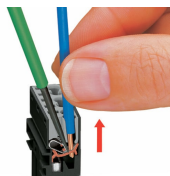

To remove the conductor, actuate the clamp via screwdriver (2.5 mm blade width) and pull out the conductor.

Installation

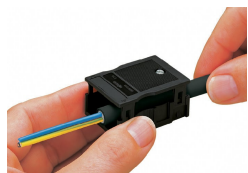

We recommend pulling the pre-latched strain relief housing over the cable prior to termination. However, the strain relief can be mounted at a later time as well.

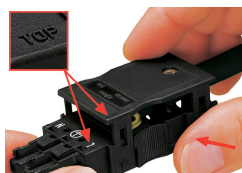

Latch the strain relief housing onto the plug/socket. Note the "TOP" inscription.



Prepare strain relief housing by snapping together upper and bottom part.



Tighten strain relief screw with screwdriver (2.5 mm blade width).

Coding



Simply cut off the coding pin from the socket.



Insert coding pin into plug (break first) until it engages.

Shield termination

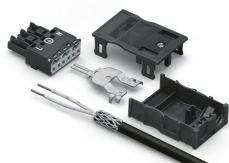

Connector with shield termination



Apply the shield to the sheathed cable.
Strip length, outer insulation = 55 mm
Shield length = 10 mm



Push the shield connecting plate into the connector until fully inserted.



First insert the wired connector into a strain relief housing, then snap cover and tighten screw.