

PSC-360

Hall-Effect End-of-Shaft Rotary Position Sensor

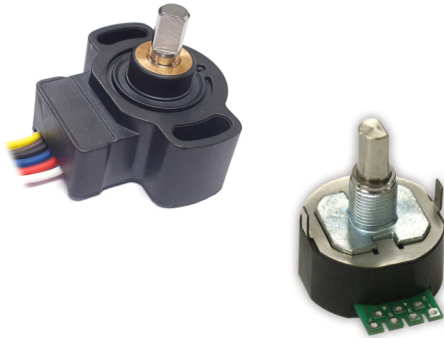

KEY FEATURES



True, contactless operation

Without any gears or mechanical interfaces the sensor is easily assembled and calibrated and subject to limited wear and tear over lifetime.

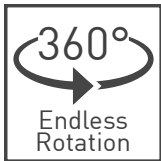

360 degree absolute position feedback

Endless mechanical rotational angle without dead band, keeps the position on power loss with programmable electrical angles from 15 to 360 degrees.



Made for harsh environments

The rugged package protects the sensor from dust, moisture, vibration and extreme temperatures for usage in the most demanding environments.



Durable and robust design

The non-contacting design allows for an extra-long product lifetime of up to 50 million cycles.

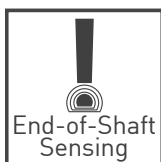

Integrated shaft

The magnet is securely fastened to the shaft and acts as only moving component in the sensor.



Adaptable to your requirements

Programmable transfer function and switch outputs as well as different output protocols and redundancy levels available.

DESCRIPTION

The robust PSC-360 is a cost-effective non-contacting rotary position sensor that provides high performance in harsh environments such as transportation, industrial and medical applications.

This compact sensor of Piher Sensing Systems is truly non-contacting with a permanent magnet that is securely fastened to the shaft and acts as the only moving component in the sensor. Redundant versions provide independent voltage outputs with fully customizable characteristics. Additionally a switch output optionally be configured.

The endless rotation sensor is highly configurable with a programmable angular range between 15 and 360 degrees, different signal output options and support for low and high-voltage power supply. Sealed, flange mounted for easy positioning and with fly leads, it can be customized to fit any desired connector configuration.

APPLICATIONS

Industrial

- ▶ Autonomous warehouse robotics
- ▶ Robotics and automation feedback
- ▶ Robot arm position
- ▶ Valve monitoring
- ▶ Conveyor operation

Transportation

- ▶ Steering wheel angle
- ▶ Pedal Position
- ▶ Suspension/height detection
- ▶ Fork height and mast tilt
- ▶ Bucket position
- ▶ Hitch position
- ▶ Transmission gear shift

Marine

- ▶ Steering and shifter sensor

Home and Building Automation

- ▶ HVAC systems

PSC-360

Hall-Effect End-of-Shaft Rotary Position Sensor

MECHANICAL SPECIFICATIONS

	PSC-360	PSC-360U
Rotational life	Up to 50.000.000 cycles	
Mechanical range	360° (endless rotation)	
Shaft diameter	6mm	6,35mm

ELECTRICAL SPECIFICATIONS

	PSC-360	PSC-360U
Linearity ¹	±1% absolute (±0.5% on request)	
Electrical angular range	Programmable from 15° to 360°	
Output protocols	Analog (Ratiometric), PWM Serial Protocol (SPI) upon request SENT upon request	Analog (Ratiometric), PWM Serial Protocol (SPI) SENT upon request
Output	Simple Redundant Full-redundant	
Switch output	On request	Programmable
Resolution	Analog, PWM SPI	Up to 12 bit Up to 14 bit
Supply voltage ²	5V ±10% 7V to 25V	5V ±10% 12V ±10% 15V ±10%
Supply current	Single version Redundant version	Typ 8.5 mA Typ 17 mA
Voltage protection	±10V	
Self-diagnostic features	yes	

¹ Ferromagnetic materials close to the sensor (i.e. shaft, mounting surface) may affect the sensor's linearity.

² Other specifications available

ENVIRONMENTAL SPECIFICATIONS

Operating and storage temperature ¹	-40° to +125°C
Shock	50g
Vibration	5-2000 Hz; 20g; Amax 0,75 mm

¹ Other specifications available

PSC-360

Hall-Effect End-of-Shaft Rotary Position Sensor

DIMENSIONS (MM)

PSC-360G2

PSC-360U - panel mount version

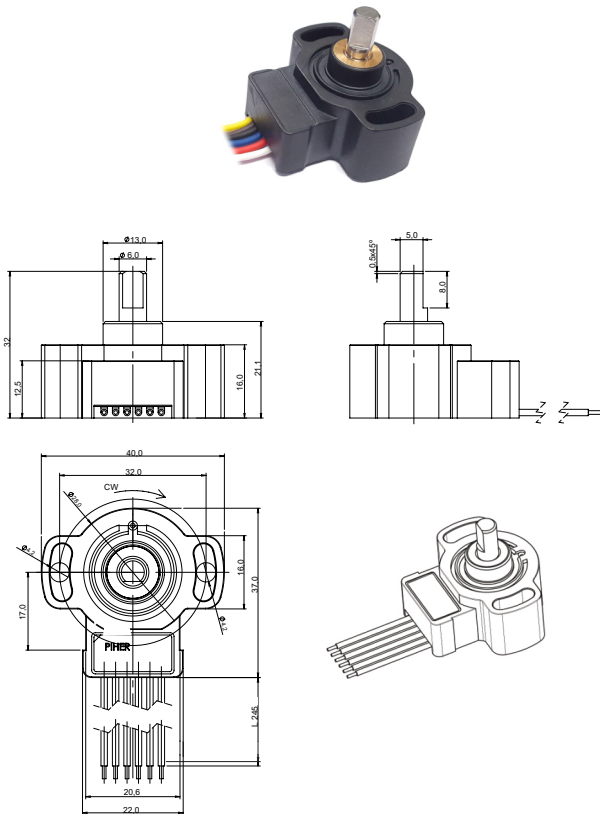

Sensor shown with the shaft at zero position.

 Download the STEP file here:
<https://piher.net/piher/?p=830>

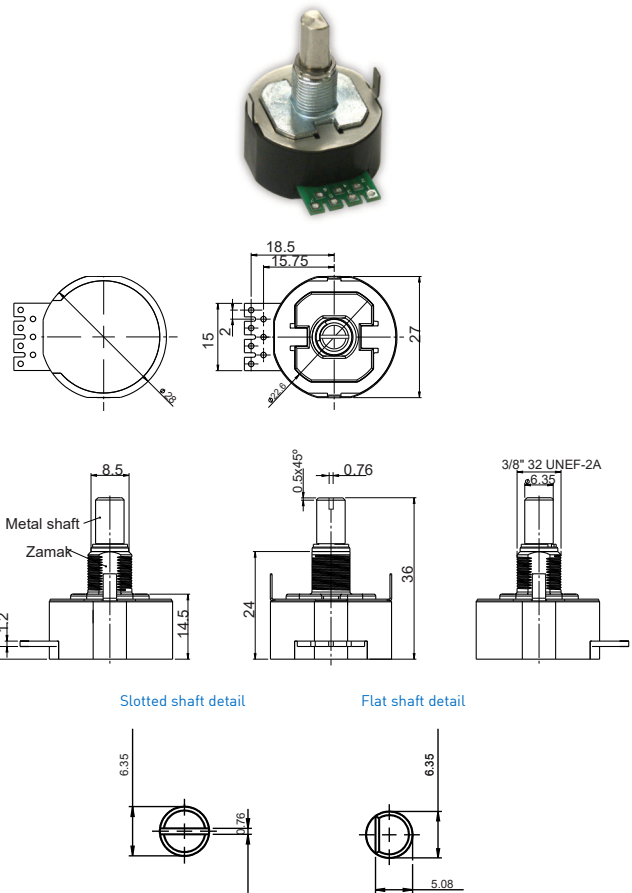

Sensor shown with the shaft at 0° position. Nut and washer included.

 Download the STEP file here:
<https://piher.net/piher/?p=1830>





Sensor delivered at random position. Assembly of any type of connector on request.

MOUNTING INSTRUCTIONS

1. Place the component on a flat surface.
2. Fit the actuator onto the shaft avoiding any mechanical play/wobble.
3. Fasten the two M4 screws (M4 washers are recommended).

CONNECTION SCHEME

Simple analog output connection wiring scheme. Other versions and connector options available upon request.

-  Brown = Power supply
-  Blue = Ground
-  Black = Signal output
-  White = Not used
-  Grey = Not used

Fly leads with Wires: 0.35mm²
 TXL SAE J1128

FOR CUSTOM SOLUTIONS CONTACT PIHER SENSING SYSTEMS



Custom design with integrated connector.

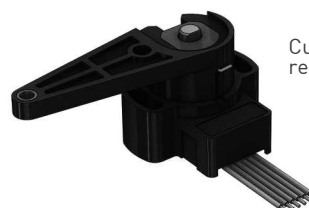

Custom design with return spring lever.

PSC-360

Hall-Effect End-of-Shaft Rotary Position Sensor



HOW TO ORDER (Example: PSC360G2-F1A-C0001-ERA360-05K)

Simple Output - Analog and PWM

PSC360G2	-	F	1	-	C_____	-	ERA____	-	___	K	-	_____
Series	Shaft	Type	Output ¹	Output function ²	Electric rotational angle ³	Voltage supply	Temp. range	PWM Frequency Hz ⁴				
	F = flat	1 = simple	A = analogic P = PWM	C0000 C0001	ERA040 ERA041 ... ERA360	05 = 5V ±10% RE = 7V-25V	K = -40°C to +125°C	[empty] = 200Hz F100 = 100Hz F101 = 101Hz ... F999 = 999Hz				

Redundant output - Analog and PWM

PSC360G2	-	F	2	-	___	-	C_____	-	ERA____	-	___	K	-	_____	_____
Series	Shaft	Type	Output ¹	Output function ²	Electric rotational angle ³	Voltage supply	Temp. range	PWM Frequency Hz. (1) ⁴	PWM Frequency Hz. (2) ⁴						
	F = flat	2 = redundant	AA= analogic PP = PWM	C0002 C0003	ERA040 ERA041 ... ERA360	05 = 5V ±10% RE = 7V-25V	K = -40°C to +125°C	F100 F101 ... F999	F100 F101 ... F999						

Full-redundant output - Analog and PWM

PSC360G2	-	F	3	-	___	-	C_____	-	ERA____	-	05	K	-	_____	_____
Series	Shaft	Type	Output ¹	Output function ²	Electric rotational angle ³	Voltage supply	Temp. range	PWM Frequency Hz. (1) ⁴	PWM Frequency Hz. (2) ⁴						
	F = flat	3 = full-redundant	AA= analogic PP = PWM	C0002 C0003	ERA040 ERA041 ... ERA360	05 = 5V ±10%	K = -40°C to +125°C	F100 F101 ... F999	F100 F101 ... F999						

1 The analog output is ratiometric, proportional:

- for supply voltage "5V" to input voltage;
- for supply voltage "RE" to 5V.

2 Other output functions available, please check availability. Enter CXXXX as long as the new output function is not defined.

3 Models with ERA < 40° available on request

4 Leave empty if not applicable. Default frequency is 200 Hz

EXAMPLE OUTPUT FUNCTIONS

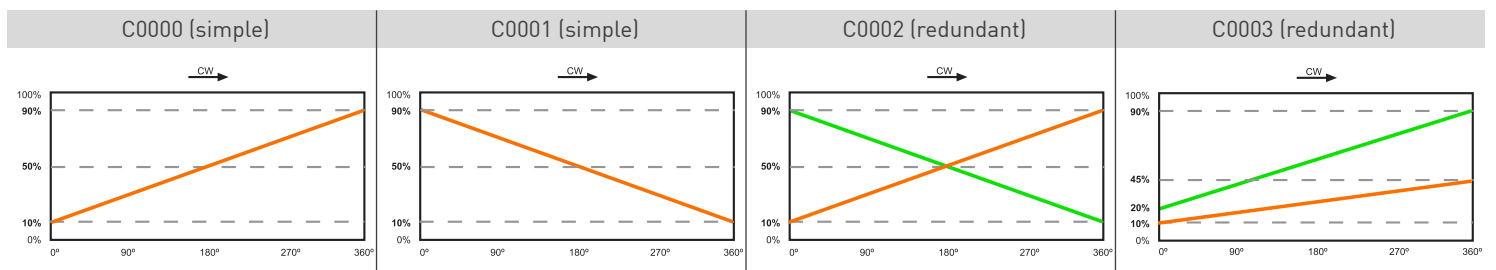

PSC-360U Panel Mount Version



HOW TO ORDER - PANEL MOUNT VERSION (Example: PSC360U-F1A-C0000-ERA360-05E)

Simple Output - Analogic and PWM

PSC360U	-	-	1	-	-	-	-	C	ERA	-	-	-	-
Series	Shaft	Type	Output ¹	Switch	Switch position ²	Output function ³	Electric rotational angle ⁴	Voltage supply	Temp. range	PWM Frequency Hz ⁵			
	F = flat shaft L = slot shaft	1 = simple	A = analogic P = PWM	[empty] = none W = switch	[empty] 000 016 ... 360	C0000 C0001	ERA040 ERA041 ... ERA360	05 = 5V 12 = 12V 15 = 15V	E = -40°C to +85°C K = -40°C to +125°C	[empty] = 200Hz F100 = 100Hz F101 = 101Hz ... F999 = 999Hz			

Simple output - SPI

PSC360U	-	-	1	S	C	ERA	-	-	-	
Series	Shaft	Type	Output	Output function ³	Electric rotational angle ⁴	Voltage supply	Temp. range			
	F = flat shaft L = slot shaft	1 = simple	S = SPI	C0000 C0001	ERA040 ERA041 ... ERA360	05 = 5V 12 = 12V 15 = 15V	E = -40°C to +85°C K = -40°C to +125°C			

Annotations:

- The analog output is ratiometric, proportional:
 - For supply voltage 5V: to input supply voltage.
 - For supply voltage 12V and 15V: to 5V.
- Leave empty if not applicable. Switch function diagram: see next page.
- Other output functions available, please check availability. Enter CXXX as long as the new output function is not defined.
- Models with ERA < 40° available on request
- Leave empty if not applicable. Default frequency is 200 Hz

Redundant output - Analogic and PWM

PSC360U	-	-	2	-	-	-	-	-	C	ERA	-	-	-	-
Series	Shaft	Type	Output ¹	Switch1	Switch1 position ²	Switch2	Switch2 position ²	Output function ³	Electric rotational angle ⁴	Voltage supply	Temp. range	PWM Frequency Hz. (1) ⁵	PWM Frequency Hz. (2) ⁵	
	F = flat shaft L = slot shaft	2 = redundant	AA= analogic PP = PWM	[empty] = none W = switch	[empty] 000 016 ... 360	[empty] = none W = switch	[empty] 000 016 ... 360	C0002 C0003	ERA040 ERA041 ... ERA360	05 = 5V 12 = 12V 15 = 15V	E = -40°C to +85°C K = -40°C to +125°C	F100 F101 ... F999	F100 F101 ... F999	

Full-redundant output - Analogic and PWM

PSC360U	-	-	3	-	-	-	-	-	C	ERA	-	-	-	-
Series	Shaft	Type	Output ¹	Switch1	Switch1 position ²	Switch2	Switch2 position ²	Output function ³	Electric rotational angle ⁴	Voltage supply	Temp. range	PWM Frequency Hz. (1) ⁵	PWM Frequency Hz. (2) ⁵	
	F = flat shaft L = slot shaft	3 = redundant	AA= analogic PP = PWM	[empty] = none W = switch	[empty] 000 016 ... 360	[empty] = none W = switch	[empty] 000 016 ... 360	C0002 C0003	ERA040 ERA041 ... ERA360	05 = 5V	E = -40°C to +85°C K = -40°C to +125°C	F100 F101 ... F999	F100 F101 ... F999	

PSC-360

Hall-Effect End-of-Shaft Rotary Position Sensor

OUTPUT VOLTAGE DEPENDING ON MAGNET POSITION

PSC360G2-F1A-C0000-ERA360-05K

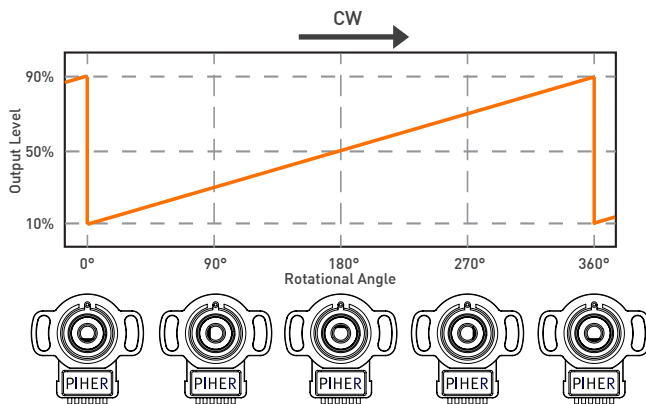

PSC360U-L1A-W180-C0072-ERA180-05K

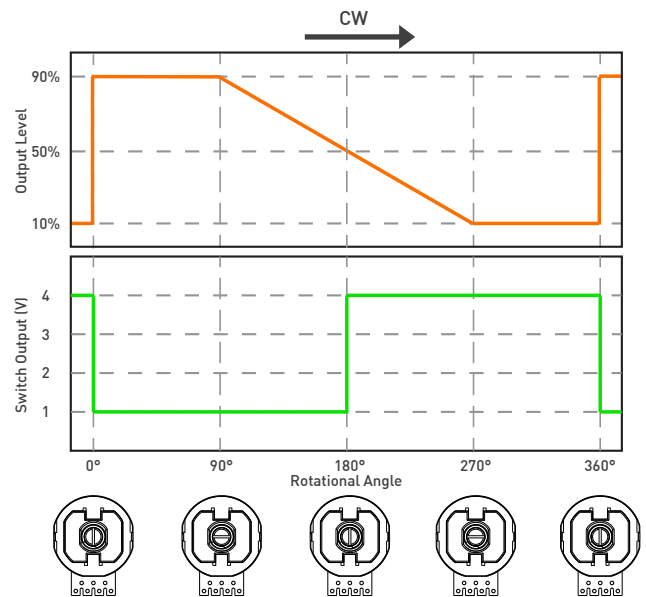

Custom output functions with up to 4 programmable points on request.

OUR ADVANTAGE

- ▶ Leading-edge innovative position sensing solutions
 - ▷ Contactless (Hall-effect and Inductive Technology)
 - ▷ Contacting (Potentiometers, Printed Electronics)
- ▶ Engineering design-in support
- ▶ All our products can be customized to fit target application and customer requirement
- ▶ Capability to move seamlessly from development to true high-volume production
- ▶ A global footprint with global engineering and commercial support
- ▶ One-stop shop not limited to position sensors (temperature, pressure, gas,...) through group collaboration
- ▶ Flexibility and entrepreneurship of a medium-sized company with the backing of Amphenol Corporation



Please always use the latest updated datasheets and 3D models published on our website.

Disclaimer:

The product information in this catalog is for reference purposes. Please consult for the most up to date and accurate design information. Piher Sensors & Controls S.A., its affiliates, agents, and employees, and all persons acting on its or their behalf (collectively, "Piher"), disclaim any and all liability for any errors, inaccuracies or incompleteness contained herein or in any other disclosure relating to any product described herein. Piher disclaims any and all liability arising out of the use or application of any product described herein or of any information provided herein to the maximum extent permitted by law. The product specifications do not expand or otherwise modify Piher's terms and conditions of sale, including but not limited to the warranty expressed therein, which apply to these products. No license, express or implied, by estoppel or otherwise, to any intellectual property rights is granted by this document or by any conduct of Piher. The products shown herein are not designed for use in medical, life-saving, or life-sustaining applications unless otherwise expressly indicated. Customers using or selling Piher products not expressly indicated for use in such applications do so entirely at their own risk and agree to fully indemnify Piher for any damages arising or resulting from such use or sale. Please contact authorized Piher personnel to obtain written terms and conditions regarding products designed for such applications. Product names and markings noted herein may be trademarks of their respective owners. Information contained in and/or attached to this catalogue may be subject to export control regulations of the European Community, USA, or other countries. Each recipient of this document is responsible to ensure that usage and/or transfer of any information contained in this document complies with all relevant export control regulations. If you are in any doubt about the export control restrictions that apply to this information, please contact the sender immediately. For any Piher Exports. Note: All products / technologies are EAR99 Classified commodities. Exports from the United States are in accordance with the Export Administration Regulations. Diversion contrary to US law is prohibited.

CONTACT

Piher Sensing Systems
 Polígono Industrial Municipal
 Vial T2, N°22
 31500 Tudela
 Spain

sales@piher.net

Europe: +34 948 820 450
Americas: +1 636 251 0855
Asia Pacific: +65 9641 8886
India: +91 9538 686 586

Rev. 21102021

Mouser Electronics

Authorized Distributor

Click to View Pricing, Inventory, Delivery & Lifecycle Information:

Amphenol:

[PSC360U-F1A-W-360-000- - -](#) [PSC360G2-F1A-C0000-ERA360-05K](#) [PSC360G2-F1A-C0007-ERA180-05K](#)
[PSC360G2-F1A-C0011-ERA090-05K](#) [PSC360G2-F2AA-C0002-ERA360-05K](#) [PSC360G2-F1A-C0000-ERA360-RE](#)
[PSC360G2-F-1A-W090-C0000-ERA360-05K](#) [PSC360G2-F1P-C0000-ERA360-05K-200](#) [PSC360G2-F1-51777](#)
[PSC360G2-F1-51786](#) [PSC360UF1-31918](#) [PSC360G2-F1-51785](#) [PSC360G2-F1-51787](#)