

Quick exhaust valves VBQF



Quick exhaust valves VBQF

Product range overview and type codes



Function

Higher piston speeds can be achieved on the return stroke of single and double-acting drives with the quick exhaust valves VBQF. Compressed air flows from the control valve via the VBQF to the drive. The

exhaust port 3 is closed at this time. When the pressure at 1 falls, exhaust flow occurs from 2 to 3. In order to implement a quick exhaust, the VBQF must be attached directly to

the supply port of the drive. The VBQF can be mounted in any position and can also be turned. The VBQF is available with or without silencer.

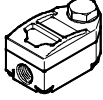
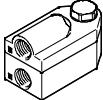
- Features:
- Minimal height
 - High flow rate
 - Improved noise emissions
 - Can be rotated (continuous rotation of the connection must, however, be avoided)

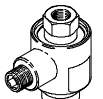
Product range overview						
Function	Version	Type	Pneumatic connection		→ Page/Internet	
			1 (valve)	2 (drive)		
Quick exhaust valves	Flat design					
		VBQF-U	With silencer	G1/8, QS-6	G1/8	3
				G1/4, QS-8	G1/4	
		VBQF-D	Without silencer	G1/8, QS-6	G1/8	3
				G1/4	G1/4	
	Compact design					
	SEU	With silencer	G1/8, G1/4, G3/8, G1/2	G1/8, G1/4, G3/8, G1/2	seu	
	SE	Without silencer	G1/8, G1/4, G3/8, G1/2, G3/4	G1/8, G1/4, G3/8, G1/2, G3/4	se	

Type codes

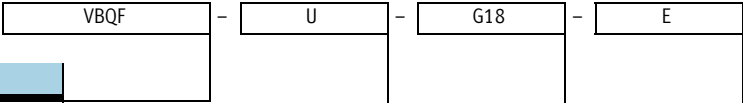

Type	
VBQF	Quick exhaust valve, flat design

Exhaust air	
U	Unducted exhaust air
D	Ducted exhaust air

Pneumatic connection 2 (drive)	
G18	Thread G1/8
G14	Thread G1/4

Pneumatic connection 1 (valve)	
E	Threaded connection, like pneumatic connection 2 (drive)
Q6	Push-in connector QS-6
Q8	Push-in connector QS-8

Quick exhaust valves VBQF

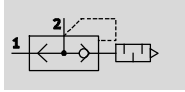

Technical data

Unducted exhaust air VBQF-U

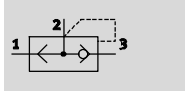

Ducted exhaust air VBQF-D



-  - Flow rate
2,500 l/min
-  - Temperature range
-20 ... +80 °C
-  - Operating pressure
0.5 ... 10 bar

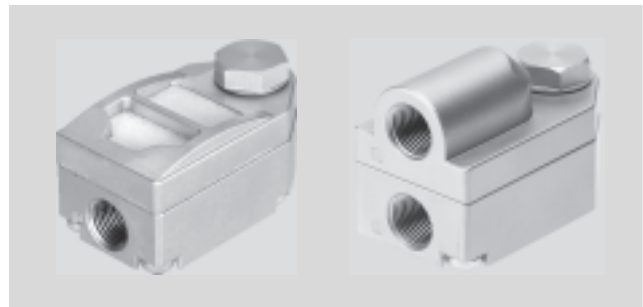

General technical data							
Exhaust air	Unducted exhaust air VBQF-U				Ducted exhaust air VBQF-D		
Pneumatic connection 2 (drive)	G $\frac{1}{8}$		G $\frac{1}{4}$		G $\frac{1}{8}$		G $\frac{1}{4}$
Pneumatic connection 1 (valve)	G $\frac{1}{8}$	QS-6	G $\frac{1}{4}$	QS-8	G $\frac{1}{8}$	QS-6	G $\frac{1}{4}$
Pneumatic connection 3 (exhaust air)	- (silencer)		- (silencer)		G $\frac{1}{8}$	QS-8	G $\frac{1}{4}$
Valve function	Quick exhaust						
Nominal size [mm]	5		7		5		7
Type of mounting	Screw-in						
Mounting position	Any						
Noise level [dB (A)]	75		75		-		-

Operating and environmental conditions		
Type of connection	Threaded connection	Push-in connector QS
Operating pressure [bar]	0.5 ... 10	
Operating medium	Compressed air in accordance with ISO 8573-1:2010 [7:4:4]	
Note on operating/pilot medium	Operation with lubricated medium possible (in which case lubricated operation will always be required)	
Ambient temperature [°C]	-20 ... +80	-10 ... +60
Temperature of medium [°C]	-20 ... +80	-10 ... +60
Corrosion resistance class CRC ¹⁾	1	

1) Corrosion resistance class 1 according to Festo standard 940 070
Components subject to low corrosion stress. Transport and storage protection. Parts that do not have primarily decorative surface requirements, e.g. in internal areas that are not visible or behind covers.

Materials	
Housing	Die-cast zinc, die-cast aluminium
Seals	NBR
Note on materials	RoHS-compliant

Quick exhaust valves VBQF

Technical data

FESTO

Dimensions Download CAD data → www.festo.com

Unducted exhaust air VBQF-U Ducted exhaust air VBQF-D

1 Silencer

Type	Connection D1	D2	D3	B1	H1	H2	L1	L2	☞
VBQF-U-G18-E	G $\frac{1}{8}$	G $\frac{1}{8}$	–	25	27.4	5.3	37	8	12
VBQF-U-G18-Q6		QS-6	–				41		
VBQF-U-G14-E	G $\frac{1}{4}$	G $\frac{1}{4}$	–	32	38	6.2	54	10.5	15
VBQF-U-G14-Q8		QS-8	–				58		
VBQF-D-G18-E	G $\frac{1}{8}$	G $\frac{1}{8}$	G $\frac{1}{8}$	25	33.9	5.3	37	8	12
VBQF-D-G18-Q6		QS-6	QS-8				41		
VBQF-D-G14-E	G $\frac{1}{4}$	G $\frac{1}{4}$	G $\frac{1}{4}$	32	42	6.2	54	10.5	15

Ordering data

Version	Pneumatic connection			Standard nominal flow rate qnN at 6 bar → 5 bar		Standard flow rate qn at 6 bar → 0 bar	Weight [g]	Part No.	Type
				Pressurisation 1 → 2	Exhausting 2 → 3	Exhausting 2 → 3			
	2	1	3	[l/min]	[l/min]	[l/min]			
Unducted exhaust air									
	G $\frac{1}{8}$	G $\frac{1}{8}$	–	350	–	1,300	84.2	547531	VBQF-U-G18-E
		QS-6	–	350	–	1,300	85.5	547532	VBQF-U-G18-Q6
	G $\frac{1}{4}$	G $\frac{1}{4}$	–	960	–	2,500	226	548001	VBQF-U-G14-E
		QS-8	–	800	–	2,500	232	548002	VBQF-U-G14-Q8
Ducted exhaust air									
	G $\frac{1}{8}$	G $\frac{1}{8}$	G $\frac{1}{8}$	350	850	1,300	102.5	547533	VBQF-D-G18-E
		QS-6	QS-8	350	850	1,300	105	547534	VBQF-D-G18-Q6
	G $\frac{1}{4}$	G $\frac{1}{4}$	G $\frac{1}{4}$	960	1,500	2,500	253	548003	VBQF-D-G14-E