

WAGO → I/O → SYSTEM 750

**Fieldbus Independent
I/O Modules**

**Analog Input Modules for RTD's
750-461 (/xxx-xxx)**



Manual

Version 1.2.1

Copyright © 2008 by WAGO Kontakttechnik GmbH & Co. KG
All rights reserved.

WAGO Kontakttechnik GmbH & Co. KG

Hansastraße 27
D-32423 Minden

Phone: +49 (0) 571/8 87 – 0
Fax: +49 (0) 571/8 87 – 1 69
E-Mail: info@wago.com
Web: <http://www.wago.com>

Technical Support

Phone: +49 (0) 571/8 87 – 5 55
Fax: +49 (0) 571/8 87 – 85 55
E-Mail: support@wago.com

Every conceivable measure has been taken to ensure the correctness and completeness of this documentation. However, as errors can never be fully excluded, we would appreciate any information or ideas at any time.

E-Mail: documentation@wago.com

We wish to point out that the software and hardware terms as well as the trademarks of companies used and/or mentioned in the present manual are generally trademark or patent protected.

Content

1 Important Notes	5
1.1 Legal Bases.....	5
1.1.1 Copyright.....	5
1.1.2 Personnel Qualifications.....	5
1.1.3 Use of the 750 Series in Compliance with Underlying Provisions	6
1.1.4 Technical Condition of Specified Devices.....	6
1.2 Standards and Guidelines for Operating the 750 Series.....	7
1.3 Symbols	8
1.4 Safety Information.....	9
1.5 Font Conventions	10
1.6 Number Notation.....	10
1.7 Scope	10
2 I/O Modules	12
2.1 Analog Input Modules.....	12
2.1.1 Overview Analog Input Modules for RTD's 750-461 (/xxx-xxx).....	12
2.1.2 750-461, (/xxx-xxx) [2 AI Pt100/ RTD]	13
2.1.2.1 Variations.....	13
2.1.2.2 View.....	14
2.1.2.3 Description.....	14
2.1.2.4 Display Elements	15
2.1.2.5 Schematic Diagram.....	16
2.1.2.6 Technical Data	17
2.1.2.7 Process Image	19
2.1.2.7.1 I/O Modules for Pt Resistance Sensors.....	19
2.1.2.7.1.1 Pt 100.....	21
2.1.2.7.1.2 Pt 1000.....	21
2.1.2.7.1.3 Pt 100 with Status Information for S5-FB250 in Data Word22	21
2.1.2.7.2 I/O Modules for Ni Resistance Sensors	23
2.1.2.7.2.1 Ni 100	23
2.1.2.7.2.2 Ni 1000 TK6180.....	24
2.1.2.7.3 I/O Modules for Resistance Measuring.....	25
2.1.2.8 Adjustable 750-461/003-000 Variation	26
2.1.3 750-461/020-000 [2 AI NTC 20kOhm].....	28
2.1.3.1 View.....	28
2.1.3.2 Description.....	29
2.1.3.3 Display Elements	30
2.1.3.4 Schematic Diagram.....	30
2.1.3.5 Technical Data	31
2.1.3.6 Process Image	32
3 Use in Hazardous Environments	33
3.1 Identification	34
3.1.1 For Europe according to CENELEC and IEC	34
3.1.2 For America according to NEC 500	37
3.2 Installation Regulations.....	38

4 • Content
Legal Bases

3.2.1	Special Conditions for Safe Operation of the ATEX and IEC Ex (acc. DEMKO 08 ATEX 142851X and IECEx PTB 07.0064).....	39
3.2.2	Special conditions for safe use (ATEX Certificate TÜV 07 ATEX 554086 X).....	40
3.2.3	Special conditions for safe use (IEC-Ex Certificate TUN 09.0001 X).....	41
3.2.4	ANSI/ISA 12.12.01	42

1 Important Notes

This section includes an overall summary of the most important safety requirements and notes that are mentioned in each individual section. To protect your health and prevent damage to devices as well, it is imperative to read and carefully follow the safety guidelines.

1.1 Legal Bases

1.1.1 Copyright

This Manual, including all figures and illustrations, is copyright-protected. Any further use of this Manual by third parties that violate pertinent copyright provisions is prohibited. Reproduction, translation, electronic and phototechnical filing/archiving (e.g., photocopying) as well as any amendments require the written consent of WAGO Kontakttechnik GmbH & Co. KG, Minden, Germany. Non-observance will involve the right to assert damage claims.

WAGO Kontakttechnik GmbH & Co. KG reserves the right to provide for any alterations or modifications that serve to increase the efficiency of technical progress. WAGO Kontakttechnik GmbH & Co. KG owns all rights arising from the granting of patents or from the legal protection of utility patents. Third-party products are always mentioned without any reference to patent rights. Thus, the existence of such rights cannot be excluded.

1.1.2 Personnel Qualifications

The use of the product described in this Manual requires special personnel qualifications, as shown in the following table:

Activity	Electrical specialist	Instructed personnel*)	Specialists**) having qualifications in PLC programming
Assembly	X	X	
Commissioning	X		X
Programming			X
Maintenance	X	X	
Troubleshooting	X		
Disassembly	X	X	

*) Instructed persons have been trained by qualified personnel or electrical specialists.

**) A specialist is a person, who – thanks to technical training – has the qualification, knowledge and expertise to meet the required specifications of this work and to identify any potential hazardous situation in the above listed fields of activity.

All responsible persons have to familiarize themselves with the underlying legal standards to be applied. WAGO Kontakttechnik GmbH & Co. KG does not assume any liability whatsoever resulting from improper handling and damage incurred to both WAGO's own and third-party products by disregarding detailed information in this Manual.

1.1.3 Use of the 750 Series in Compliance with Underlying Provisions

Couplers, controllers and I/O modules found in the modular WAGO-I/O-SYSTEM 750 receive digital and analog signals from sensors and transmit them to the actuators or higher-level control systems. Using programmable controllers, the signals can also be (pre-)processed.

The components have been developed for use in an environment that meets the IP20 protection class criteria. Protection against finger injury and solid impurities up to 12.5 mm diameter is assured; protection against water damage is not ensured. Unless otherwise specified, operation of the components in wet and dusty environments is prohibited.

1.1.4 Technical Condition of Specified Devices

The components to be supplied Ex Works, are equipped with hardware and software configurations, which meet the individual application requirements. Changes in hardware, software and firmware are permitted exclusively within the framework of the various alternatives that are documented in the specific manuals. WAGO Kontakttechnik GmbH & Co. KG will be exempted from any liability in case of changes in hardware or software as well as to non-compliant usage of components.

Please send your request for modified and new hardware or software configurations directly to WAGO Kontakttechnik GmbH & Co. KG.

1.2 Standards and Guidelines for Operating the 750 Series

Please adhere to the standards and guidelines required for the use of your system:

- The data and power lines shall be connected and installed in compliance with the standards required to avoid failures on your system and to substantially minimize any imminently hazardous situations resulting in personal injury.
- For assembly, start-up, maintenance and troubleshooting, adhere to the specific accident prevention provisions which apply to your system (e.g. BGV A 3, "Electrical Installations and Equipment").
- Emergency stop functions and equipment shall not be made ineffective. See relevant standards (e.g. DIN EN 418).
- The equipment of your system shall be conform to EMC guidelines so that any electromagnetic interferences will be eliminated.
- Operating 750 Series components in home applications without further measures is permitted only if they meet the emission limits (emissions of interference) in compliance with EN 61000-6-3. You will find the detailed information in section "WAGO-I/O-SYSTEM 750" → "System Description" → "Technical Data".
- Please observe the safety precautions against electrostatic discharge in accordance with DIN EN 61340-5-1/-3. When handling the modules, please ensure that environmental factors (persons, working place and packaging) are well grounded.
- The valid standards and guidelines applicable for the installation of switch cabinets shall be adhered to.

1.3 Symbols



Danger

Always observe this information to protect persons from injury.



Warning

Always observe this information to prevent damage to the device.



Attention

Marginal conditions that must always be observed to ensure smooth and efficient operation.



ESD (Electrostatic Discharge)

Warning of damage to the components through electrostatic discharge. Observe the precautionary measure for handling components at risk of electrostatic discharge.



Note

Make important notes that are to be complied with so that a trouble-free and efficient device operation can be guaranteed.



Additional Information

References to additional literature, manuals, data sheets and internet pages.

1.4 Safety Information

When connecting the device to your installation and during operation, the following safety notes must be observed:



Danger

The WAGO-I/O-SYSTEM 750 and its components are an open system. It must only be assembled in housings, cabinets or in electrical operation rooms. Access is only permitted via a key or tool to authorized qualified personnel.



Danger

All power sources to the device must always be switched off before carrying out any installation, repair or maintenance work.



Warning

Replace defective or damaged device/module (e.g. in the event of deformed contacts), as the functionality of field bus station in question can no longer be ensured on a long-term basis.



Warning

The components are not resistant against materials having seeping and insulating properties. Belonging to this group of materials is: e.g. aerosols, silicones, triglycerides (found in some hand creams). If it cannot be ruled out that these materials appear in the component environment, then the components must be installed in an enclosure that is resistant against the above mentioned materials. Clean tools and materials are generally required to operate the device/module.



Warning

Soiled contacts must be cleaned using oil-free compressed air or with ethyl alcohol and leather cloths.



Warning

Do not use contact sprays, which could possibly impair the functioning of the contact area.



Warning

Avoid reverse polarity of data and power lines, as this may damage the devices.



ESD (Electrostatic Discharge)

The devices are equipped with electronic components that may be destroyed by electrostatic discharge when touched.



Warning

For components with ETHERNET/RJ-45 connectors:
Only for use in LAN, not for connection to telecommunication circuits.

1.5 Font Conventions

- italic* Names of paths and data files are marked in italic-type.
e.g.: *C:\Programs\WAGO-IO-CHECK*
- italic* Menu items are marked in italic-type, bold letters.
e.g.: ***Save***
- \ A backslash between two names characterizes the selection of a menu point from a menu.
e.g.: ***File \ New***
- END** Pushbuttons are marked as bold with small capitals
e.g.: **ENTER**
- <>** Keys are marked bold within angle brackets
e.g.: **<F5>**
- Courier** The print font for program codes is Courier.
e.g.: **END_VAR**

1.6 Number Notation

Number code	Example	Note
Decimal	100	Normal notation
Hexadecimal	0x64	C notation
Binary	'100' '0110.0100'	In quotation marks, nibble separated with dots (.)

1.7 Scope

This manual describes the Analog Input Modules 750-461 (/xxx-xxx)
Analog Input Modules for RTD's of the modular WAGO-I/O-SYSTEM 750.

Handling, assembly and start-up are described in the manual of the Fieldbus Coupler. Therefore this documentation is valid only in the connection with the appropriate manual.

2 I/O Modules

2.1 Analog Input Modules

2.1.1 Overview Analog Input Modules for RTD's 750-461 (/xxx-xxx)

I/O Module	750-461	750-461/ 000-002	750-461/ 000-003	750-461/ 000-004	750-461/ 000-005	750-461/ 000-006
Function	PT100/ RTD	Resistance Measuring 10R-1k2	PT1000/ RTD	Ni 100/ RTD	Ni 1000/ RTD, TK6180	PT100/ RTD/ high precision
Channels	2	2	2	2	2	2
Measuring range	-200 °C ... +850 °C	10 Ω ... 1,2 kΩ	-200 °C ... +850 °C	-60 °C ... +250 °C	-60 °C ... +250 °C	-200 °C ... +850 °C
Counter depth	2 x 16 bits Data 2 x 8 bits Control/ Status (option)	2 x 16 bits Data 2 x 8 bits Control/ Status (option)	2 x 16 bits Data 2 x 8 bits Control/ Status (option)	2 x 16 bits Data 2 x 8 bits Control/ Status (option)	2 x 16 bits Data 2 x 8 bits Control/ Status (option)	2 x 16 bits Data 2 x 8 bits Control/ Status (option)

I/O Module	750-461/ 000-007	750-461/ 000-009	750-461/ 000-200	750-461/ 003-000	750-461/ 020-000	750-461/ 025-006
Function	Resistance Measuring 10R-5k0	Ni 1000/ RTD, TK5000	PT100/ RTD/ with status informatio ns	PT100/ RTD/ adjustable	NTC 20kOhm	PT100/ RTD/ high precision
Channels	2	2	2	2	2	2
Measuring range	10 Ω ... 5,0 kΩ	-30 °C ... +122 °C	-200 °C ... +850 °C,	-200 °C ... +850 °C	-30 °C ... +130 °C	-200 °C ... +850 °C
Counter depth	2 x 16 bits Data 2 x 8 bits Control/ Status (option)	2 x 16 bits Data 2 x 8 bits Control/ Status (option)	2 x 16 bits Data 2 x 8 bits Control/ Status (option)	2 x 16 bits Data 2 x 8 bits Control/ Status (option)	2 x 16 bits Data 2 x 8 bits Control/ Status (option)	2 x 16 bits Data 2 x 8 bits Control/ Status (option)

2.1.2 750-461, (/xxx-xxx) [2 AI Pt100/ RTD]

2-Channel Analog Input Module for RTDs

2- or 3-wire connection

2.1.2.1 Variations

Item-No.	Designation	Description
Pt resistance sensors		
750-461	2 AI PT100/RTD	2-Channel Analog Input Module, Pt 100 Measuring range: -200 °C ... +850 °C
750-461/000-003	2 AI PT1000/RTD	2-Channel Analog Input Module, Pt 1000 Measuring range: -200 °C ... +850 °C
750-461/000-006	2 AI PT100/RTD/ high precision	2-Channel Analog Input Module, Pt 100 Measuring range: -200 °C ... +850 °C
750-461/000-200	2 AI PT100/RTD/ With status information	2-Channel Analog Input Module, Pt 100 Measuring range: -200 °C ... +850 °C, With status information for S5-FB250
750-461/025-000	2 AI PT100/RTD/T	2-Channel Analog Input Module, Pt 100 Measuring range: -200 °C ... +850 °C, extended Temperature Range
Ni resistance sensors		
750-461/000-004	2 AI Ni 100/RTD	2-Channel Analog Input Module, Ni 100 Measuring range: -60 °C ... +250 °C
750-461/000-005	2 AI Ni 1000/RTD	2-Channel Analog Input Module, Ni 1000 Measuring range: -60 °C ... +250 °C, TK6180
750-461/000-009	2 AI Ni 1000/RTD/ TK5000	2-Channel Analog Input Module, Ni 1000 Measuring range: -30 °C ... +122 °C, TK5000
Resistance measuring		
750-461/000-002	2 AI Resistance Measuring, 10R-1k2	2-Channel Analog Input Module, Resistance measuring, Measuring range: 10 Ω ... 1,2 kΩ
750-461/000-007	2 AI Resistance Measuring, 10R-5k0	2-Channel Analog Input Module, Resistance measuring, Measuring range: 10 Ω ... 5,0 kΩ
Operating mode configurable with WAGO-I/O-CHECK		
750-461/003-000	2 AI PT100/RTD/ Adjustable	2-Channel Analog Input Module, Adjustable; Factory preset: Pt 100 Measuring range: -200 °C ... +850 °C
750-461/020-000	2AI NTC 20kOhm	2-Channel Input Module for RTDs, NTC 20kOhm

2.1.2.2 View

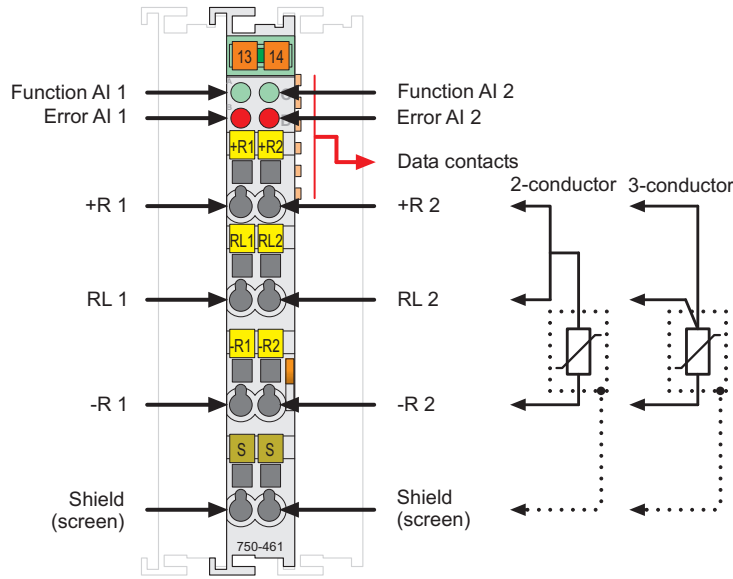

Fig. 2.1.2-1: View

g046100e

2.1.2.3 Description

The 750-461 analog input module and its 750-461/xxx-xxx variations allow Pt or Ni Resistive Temperature Devices, RTDs, to be measured in the field. It can also be used to measure resistances in the field.

Depending on the operating mode, the resistance value is converted to a temperature or directly sent out by the module. A microprocessor within the module is used for converting and linearizing the measured resistance value into a numeric value proportional to the temperature of the selected resistance sensor.

The operating mode of the 750-461/003-000 variation can be set by using the **WAGO-I/O-CHECK 2** start-up and diagnostic tool (Item No.: 759-302). The default setting is Pt 100. After setting the parameters, the module behaves like the version with the selected operating mode.

The operating mode of the 750-461 basic module described in this manual is for a Pt 100 resistance sensor.

The analog input module is a 2- to 3-conductor device and has 2 input channels. Two devices may be directly connected to the module.

For example, two 3-wire sensors can be connected either to +R1, RL1 and -R1 or to +R2, RL2 and -R2. For the connection of 2-wire sensors, putting of a bridge is necessary between +R1 and RL1 or +R2 and RL2.

The shield (screen) is directly connected to the DIN rail. A capacitive connection is made automatically when snapped onto the DIN rail.

An optocoupler is used for electrical isolation between the bus and the field side.

The operational readiness and trouble-free internal data bus communication of the channels are indicated via a green function LED. A broken wire, short-

circuit or overrange are indicated by a red error LED per channel.
 After the error has been corrected, the module needs up to 4 seconds to output a correct measured value, the module 750-461/000-006 needs up to 12 seconds. Any configuration of the input modules is possible when designing the fieldbus node. Grouping of module types is not necessary.



Attention

This module has no power contacts. For field supply to downstream I/O modules, a supply module will be needed.

The analog input module 750-461 and its variations can be used with all couplers/controllers of the WAGO-I/O-SYSTEM 750 (except for the economy types 750-320, -323, -324 and -327).

2.1.2.4 Display Elements

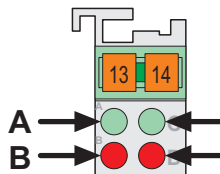

Fig. 2.1.2-2:
 Display Elements
 g045202x

LED	Channel	State	Function	
A	1	off	No operational readiness or the internal data bus communication is interrupted	
		green	Operational readiness and trouble-free internal data bus communication	
off		Normal operation		
red		750-461, 750-461/000-003, -004, -005, -006	Overrange/underflow of the admissible measuring range, broken wire	
		750-461/000-200	Overrange of the admissible measuring range, broken wire	
		750-461/000-002	Overrange/underflow of the admissible measuring range	
		750-461/000-007	Overrange of the admissible measuring range	
C		2	off	No operational readiness or the internal data bus communication is interrupted
	green		Operational readiness and trouble-free internal data bus communication	
off	Normal operation			
red	750-461, 750-461/000-003, -004, -005, -006		Overrange/underflow of the admissible measuring range, broken wire	
	750-461/000-200		Overrange of the admissible measuring range, broken wire	
	750-461/000-002		Overrange/underflow of the admissible measuring range	
	750-461/000-007		Overrange of the admissible measuring range	
D				

2.1.2.5 Schematic Diagram

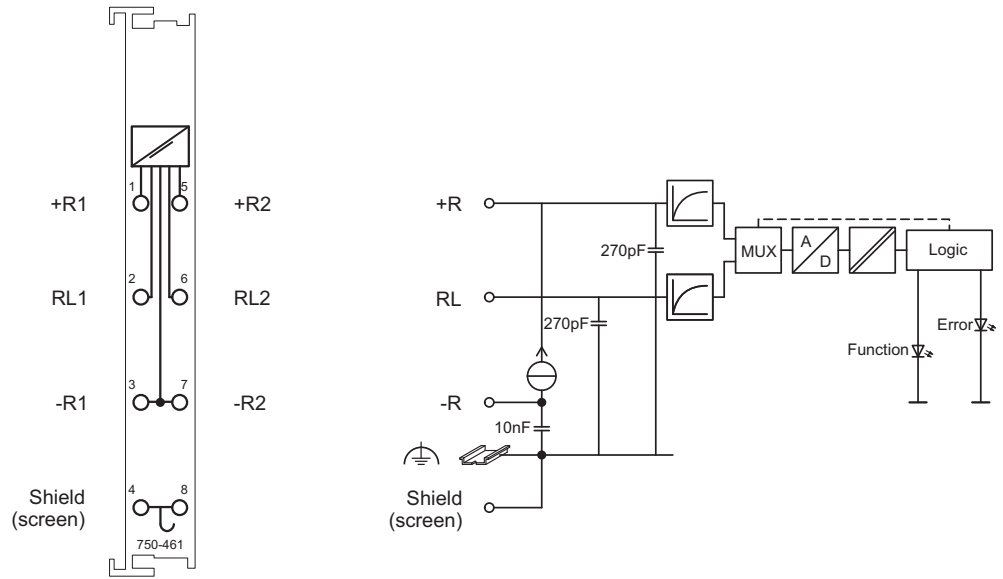













Fig. 2.1.2-3: Schematic Diagram



g046101e

2.1.2.6 Technical Data



Module Specific Data	
Number of inputs	2
Voltage supply	via system voltage DC /DC
Current consumption _{max.} (internal)	80 mA
Sensor types (the free configurable variation supports all listed sensor types)	Pt 100 (factory preset), optionally orderable variants for Pt 1000, Ni 100, Ni 120, Ni 1000 TK6180, Ni 1000 TK5000, resistance measuring.
Sensor connection	3-wire (factory preset) or 2-wire
Temperature range	-200 °C ... +850 °C (Pt) -60 °C ... +250 °C (Ni100, Ni100TK6180) -30 °C ... +122 °C (Ni100TK5000)
Resolution	0,1 °C
Conversion time	320 ms (per channel) 960 ms (per channel for 750-461/000-006)
Response delay _{max.} (time from starting or connecting the sensor to the first proper measured value)	4 s 12 s (for 750-461/000-006)
Measuring error _{25°C}	<± 0.2 % of full scale value
Temperature coefficient	<± 0.01 % /K of full scale value <± 0,001 % /K of full scale value (for 750-461/000-006)
Isolation	500 V (System/Supply)
Measured current _{typ.}	0.5 mA
Bit width	2 x 16 bits data 2 x 8 bits control/status (option)
Dimensions (mm) W x H x L	12 x 64* x 100 * from upper edge of 35 DIN rail
Weight	ca. 55 g
Standards and Regulations (cf. Chapter 2.2 of the Coupler/Controller Manual)	
EMC-Immunity to interference (CE)	acc. to EN 61000-6-2: 2005
EMC-Emission of interference (CE)	acc. to EN 61000-6-4: 2007
EMC-Immunity to interference (Ship building)	acc. to Germanischer Lloyd (2003)
EMC-Emission of interference (Ship building)	acc. to Germanischer Lloyd (2003)

Approvals (cf. Chapter 2.2 of the Coupler/Controller Manual)		
	Conformity Marking	
	cUL _{US} (UL508)	
	ABS (American Bureau of Shipping)	
	BV (Bureau Veritas)	
	DNV (Det Norske Veritas)	Cl. B
	GL (Germanischer Lloyd)	Cat. A, B, C, D
	KR (Korean Register of Shipping)	
	LR (Lloyd's Register)	Env. 1, 2, 3, 4
	NKK (Nippon Kaiji Kyokai)	
	PRS (Polski Rejestr Statków)	
	RINA (Registro Italiano Navale)	

The following Ex approvals have been granted to the basic version of 750-461 I/O modules:

	TÜV (07 ATEX 554086 X)	I M2 Ex d I II 3 G Ex nA IIC T4 II 3 D Ex tD A22 IP6X T135°C
	Permissible operation temperature: 0 °C ≤ TA ≤ +60 °C	
	TÜV (TUN 09.0001X)	Ex d I Ex nA IIC T4 Ex tD A22 IP6X T135°C
	Permissible operation temperature: 0 °C ≤ TA ≤ +60 °C	
	cUL _{US} (ANSI/ISA 12.12.01)	Class I Div2 ABCD T4

The following Ex approvals have been granted to the variation 750-461/000-xxx and the variation 750-461/003-000:

	DEMKO (08 ATEX 142851X)	I M2/ II 3 GD Ex nA IIC T4
	cUL _{US} (ANSI/ISA 12.12.01)	Class I Div2 ABCD T4



More Information

Detailed references to the approvals are listed in the document "Overview Approvals WAGO-I/O-SYSTEM 750", which you can find on the CD ROM ELECTRONICC Tools and Docs (Item-No.: 0888-0412) or in the internet under: <http://www.wago.com> → Documentation → WAGO-I/O-SYSTEM 750 → System Description

2.1.2.7 Process Image

Some fieldbus systems can process input channel status information by means of a status byte.

This status byte can be displayed via the WAGO-I/O-CHECK 2 start-up and diagnostic tool. However, processing via the coupler / controller is optional, which means that accessing or parsing the status information depends on the fieldbus system.



Attention

The representation of the process data of some I/O modules or their variations in the process image depends on the fieldbus coupler/-controller used. Please take this information as well as the particular design of the respective control/status bytes from the section "Fieldbus Specific Design of the Process Data" included in the description concerning the process image of the corresponding coupler/controller.

2.1.2.7.1 I/O Modules for Pt Resistance Sensors

Pt resistance sensors (Measuring range: -200 °C ... +850 °C)	
750-461	Evaluation of Pt 100
750-461/000-003	Evaluation of Pt 1000
750-461/000-006	Evaluation of Pt 100, high precision (0.001%/K) (Conversion time 960ms)
750-461/000-200	Evaluation of Pt 100, with status information for S5-FB250

To evaluate the platinum resistance sensors (750-461, 750-461/000-003 and 750-461/000-006) the measured values of the resistance are converted and sent as temperature values.

All temperature values are represented in a standard numeric format. The possible numerical range matches the defined temperature range of the Pt sensors from -200 °C to +850 °C.

In the Pt 100 or Pt 1000 setting, the temperature values of the sensors are represented with a resolution of 1 digit per 0.1 °C within a word (16 bits).

Thus, 0 °C corresponds to the numeric value 0x0000 and 100 °C to 0x03E8 (dec. 1000).

Temperature values below 0 °C are represented in two's complement binary form.

The measured values of the resistance are directly sent by the 750-461/000-200 (Pt 100) module.

2.1.2.7.1.1 Pt 100

The analog input modules 750-461 and 750-461/000-006 transmit 16-bit measured values per channel as well as 8 optional status bits to the coupler/controller.

However, accessing the status byte depends on the fieldbus system being used.

750-461, /000-006 (Pt 100)						
Temperature °C	Resistance Ω	Numerical value ¹⁾			Status- byte Hex.	LED Error AI 1, 2
		binary	hex.	dec.		
<-200.0	10.00	'1000.0000.0000.0001'	0x8001	-32767	0x41	on
-200.0	18.49	'1111.1000.0011.0000'	0xF830	-2000	0x00	off
-100.0	60.25	'1111.1100.0001.1000'	0xFC18	-1000	0x00	off
0.0	100.00	'0000.0000.0000.0000'	0x0000	0	0x00	off
100.0	138.50	'0000.0011.1110.1000'	0x03E8	1000	0x00	off
200.0	175.84	'0000.0111.1101.0000'	0x07D0	2000	0x00	off
500.0	280.90	'0001.0011.1000.1000'	0x1388	5000	0x00	off
750.0	360.47	'0001.1101.0100.1100'	0x1D4C	7500	0x00	off
800.0	375.51	'0001.1111.0100.0000'	0x1F40	8000	0x00	off
850.0	390.26	'0010.0001.0011.0100'	0x2134	8500	0x00	off
>850.0	>390.26	'0010.0001.0011.0100'	0x2134	8500	0x42	on
Broken wire against R _L		'0010.0001.0011.0100'	0x2134	8500	0x42	on

¹⁾ Temperature values below 0 °C are represented in two's complement binary form.

The measured value can exceed the range from decimal –2000 to 8500 until the limitation applies.

2.1.2.7.1.2 Pt 1000

The analog input modules 750-461/000-003 transmit 16-bit measured values per channel as well as 8 optional status bits to the coupler/controller.

However, accessing the status byte depends on the fieldbus system being used.

750-461/000-003 (Pt 1000)						
Temperature °C	Resistance Ω	Numerical value ¹⁾			Status- byte Hex.	LED Error AI 1, 2
		binary	hex.	dec.		
<-200.0	100.00	'1000.0000.0000.0001'	0x8001	-32767	0x41	on
-200.0	184.93	'1111.1000.0011.0000'	0xF830	-2000	0x00	off
-100.0	602.54	'1111.1100.0001.1000'	0xFC18	-1000	0x00	off
0.0	1000.00	'0000.0000.0000.0000'	0x0000	0	0x00	off
100.0	1385.00	'0000.0011.1110.1000'	0x03E8	1000	0x00	off
200.0	1758.40	'0000.0111.1101.0000'	0x07D0	2000	0x00	off
500.0	2808.96	'0001.0011.1000.1000'	0x1388	5000	0x00	off
750.0	3604.65	'0001.1101.0100.1100'	0x1D4C	7500	0x00	off
800.0	3755.09	'0001.1111.0100.0000'	0x1F40	8000	0x00	off
850.0	3902.62	'0010.0001.0011.0100'	0x2134	8500	0x00	off
>850.0	>3902.62	'0010.0001.0011.0100'	0x2134	8500	0x42	on
Broken wire against R _L		'0010.0001.0011.0100'	0x2134	8500	0x42	on

¹⁾ Temperature values below 0 °C are represented in two's complement binary form.

The measured value can exceed the range from decimal –2000 to 8500 until the limitation applies.

2.1.2.7.1.3 Pt 100 with Status Information for S5-FB250 in Data Word

The analog input module 750-461/000-200 transmits 16-bit measured values per channel as well as 8 optional status bits to the coupler/controller.

When a S5 is used as higher-level control system, this data can be directly processed using the FB 250 function block.

However, accessing the status byte depends on the fieldbus system being used.

The status information is mapped to bits 0 to 2 and the digitized measured value to bits 3 to 14.

750-461/000-200							
Tem- perature °C	Resis- tance Ω	Numerical value ²⁾ with status information ¹⁾				Status- byte hex.	LED Error AI 1,2
		binary	XFÜ ₁₎	hex.	dec.		
	10	'0000.0011.0011.0	000'	0x0330	819	0x00	off
-200.0	20	'0000.0110.0110.0	000'	0x0660	1638	0x00	off
-185.0	25	'0000.1000.0000.0	000'	0x0800	2048	0x00	off
-125.0	50	'0001.0000.0000.0	000'	0x1000	4096	0x00	off
0.0	100	'0010.0000.0000.0	000'	0x2000	8192	0x00	off
266.0	200	'0100.0000.0000.0	000'	0x4000	16384	0x00	off
560.0	300	'0110.0000.0000.0	000'	0x6000	24576	0x00	off
850.0	390	'0111.1100.1100.1	000'	0x7CC8	32949	0x00	off
	800	'1111.1111.1111.1	000'	0xFFF8	65535	0x00	off
	>800	undefined				0x00	off
	>ca.1200	'0001.0000.0001.0	001'	0x1011	4113	0x42	on

¹⁾ Status information: X: not used, F: short-circuit, broken wire, Ü: overrange

²⁾ Temperature values below 0 °C are represented in two's complement binary form.

Values marked with "ca." are not calibrated.

2.1.2.7.2 I/O Modules for Ni Resistance Sensors

Ni resistance sensors (Measuring range: -60 °C ... +250 °C)	
750-461/000-004	Evaluation of Ni 100
750-461/000-005	Evaluation of Ni 1000 TK6180
750-461/000-009	Auswertung Ni 1000 TK5000, Messbereich: -30 °C ... +122 °C

To evaluate the nickel resistance sensors, the measured values of the resistance are converted and sent as temperature values.

All temperature values are represented in a standard numeric format. The possible numerical range matches the defined temperature range of the Ni sensors from -60 °C to +250 °C.

2.1.2.7.2.1 Ni 100

In the Ni 100 setting 750-461/000-004, the temperature values of the sensors are represented with a resolution of 1 digit per 0.1 °C within a word (16 bits). Thus, 0 °C corresponds to the numeric value 0x0000 and 100 °C to 0x03E8 (dec. 1000).

Temperature values below 0 °C are represented in two's complement binary form.

The analog input modules transmits 16-bit measured values per channel as well as 8 optional status bits to the coupler/controller.

750-461/000-004 (Ni 100)						
Tem- perature °C	Resis- tance Ω	Numerical value ¹⁾			Status- byte hex.	LED Error AI 1,2
		binary	hex.	dec.		
<-60.0	< 69.16	'1000.0000.0000.0001'	0x8001	-32767	0x41	on
-60.0	69.16	'1111.1101.1010.1000'	0xFDA8	-600	0x00	off
-50.0	74.26	'1111.1110.0000.1100'	0xFE0C	-500	0x00	off
0.0	100.00	'0000.0000.0000.0000'	0x0000	0	0x00	off
50.0	129.10	'0000.0001.1111.0100'	0x01F4	500	0x00	off
100.0	161.77	'0000.0011.1110.1000'	0x03E8	1000	0x00	off
150.0	198.62	'0000.0101.1101.1100'	0x05DC	1500	0x00	off
200.0	240.64	'0000.0111.1101.0000'	0x07D0	2000	0x00	off
250.0	289.13	'0000.1001.1100.0100'	0x09C4	2500	0x00	off
>250.0	>289.13	'0010.0001.0011.0100'	0x2134	8500	0x42	on
Broken wire against R _L		'0010.0001.0011.0100'	0x2134	8500	0x42	on

¹⁾ Temperature values below 0 °C are represented in two's complement binary form.

The measured value can exceed the range from decimal -600 to 2500 until the limitation applies.

2.1.2.7.2.2 Ni 1000 TK6180

In the Ni 1000 setting 750-461/000-005, the temperature values of the sensors are represented with a resolution of 1 digit per 0.1 °C within a word (16 bits). Thus, 0 °C corresponds to the numeric value 0x0000 and 100 °C to 0x03E8 (dec. 1000).

Temperature values below 0 °C are represented in two's complement binary form.

The analog input modules transmits 16-bit measured values per channel as well as 8 optional status bits to the coupler/controller.

750-461/000-005 (Ni 1000 TK6180)						
Temperature °C	Resistance Ω	Numerical value ¹⁾			Status- byte hex.	LED Error AI 1,2
		binary	hex.	dec.		
<-60.0	< 691.60	'1000.0000.0000.0001'	0x8001	-32767	0x41	on
-60.0	691.60	'1111.1101.1010.1000'	0xFDA8	-600	0x00	off
-50.0	742.60	'1111.1110.0000.1100'	0xFE0C	-500	0x00	off
0.0	1000.00	'0000.0000.0000.0000'	0x0000	0	0x00	off
50.0	1291.00	'0000.0001.1111.0100'	0x01F4	500	0x00	off
100.0	1617.96	'0000.0011.1110.1000'	0x03E8	1000	0x00	off
150.0	1986.20	'0000.0101.1101.1100'	0x05DC	1500	0x00	off
200.0	2406.40	'0000.0111.1101.0000'	0x07D0	2000	0x00	off
250.0	2891.31	'0000.1001.1100.0100'	0x09C4	2500	0x00	off
>250.0	>2891.31	'0010.0001.0011.0100'	0x2134	8500	0x42	on
Broken wire against R _L		'0010.0001.0011.0100'	0x2134	8500	0x42	on

¹⁾ Temperature values below 0 °C are represented in two's complement binary form.

The measured value can exceed the range from decimal -600 to 2500 until the limitation applies.

2.1.2.7.3 I/O Modules for Resistance Measuring

Resistance measuring	
750-461/000-002	Resistance measuring, Measuring range: 10 Ω ... 1.2 kΩ
750-461/000-007	Resistance measuring, Measuring range: 10 Ω ... 5.0 kΩ

The measured values are sent out directly when measuring the resistance. Using the 750-461/000-002 module with measuring range from 10 Ω to 1.2 kΩ, the resolution is 1 digit per 0.1 Ω.

Using the 750-461/000-007 module with measuring range from 10 Ω to 5.0 kΩ, the resolution is 1 digit per 0.5 Ω.

Resistance measurement is only possible in 2-wire connection technology.

The analog input module transmits 16-bit measured values per channel as well as 8 optional status bits to the coupler/controller.

750-461/000-002 (10 Ω ... 1.2 kΩ)					
Resistance Ω	Numerical value			Status- byte hex.	LED Error AI 1,2
	binary	hex.	dec.		
0	'1110.1100.0000.0000'	0xEC00	-5120	0x00	off
10	'0000.0000.0110.0100'	0x0064	100	0x00	off
100	'0000.0011.1110.1000'	0x03E8	1000	0x00	off
200	'0000.0111.1101.0000'	0x07D0	2000	0x00	off
300	'0000.1011.1011.1000'	0x0BB8	3000	0x00	off
400	'0000.1111.1010.0000'	0x0FA0	4000	0x00	off
500	'0001.0011.1000.1000'	0x1388	5000	0x00	off
750	'0001.1101.0100.1100'	0x1D4C	7500	0x00	off
1000	'0010.0111.0001.0000'	0x2710	10000	0x00	off
1200	'0010.1110.1110.0000'	0x2EE0	12000	0x00	off
>ca.1200	'0010.0001.0011.0100'	0x2134	8500	0x42	on

Values marked with "ca." are not calibrated.

750-461/000-007 (10 Ω ... 5.0 kΩ)					
Resistance Ω	Numerical value			Status- byte hex.	LED Error AI 1,2
	binary ¹⁾	hex.	dec.		
0	'1110.1100.0000.0000'	0xEC00	-5120	0x00	off
10	'0000.0000.0001.0100'	0x0014	20	0x00	off
100	'0000.0000.1100.1000'	0x00C8	200	0x00	off
200	'0000.0001.1001.0000'	0x0190	400	0x00	off
300	'0000.0010.0101.1000'	0x0258	600	0x00	off
1000	'0000.0111.1101.0000'	0x07D0	2000	0x00	off
2000	'0000.1111.1010.0000'	0x0FA0	4000	0x00	off
3000	'0001.0111.0111.0000'	0x1770	6000	0x00	off
4000	'0001.1111.0100.0000'	0x1F40	8000	0x00	off
5000	'0010.0111.0001.0000'	0x2710	10000	0x00	off
>ca.5000	'0010.0111.0001.0000'	0x2710	10000	0x42	on

Values marked with "ca." are not calibrated.

2.1.2.8 Adjustable 750-461/003-000 Variation

The operating mode of the 750-461/003-000 variation can be parameterized using the **WAGO-I/O-CHECK 2** start-up and diagnostic tool (Item No.: 759-302).

The default setting is Pt 100. In this operating mode, the module has the same behavior and process values as the 750-461 basic module.

The parameter dialog box of **WAGO-I/O-CHECK 2** contains select boxes that are used to set this module.

Select box	Available settings	
RTD Type	Pt100 (-200 °C – 850 °C)* / Pt200 (-200 °C – 850 °C) / Pt500 (-200 °C – 850 °C) / Pt1000 (-200 °C – 850 °C) / Ni120 (-80 °C – 320 °C) / Ni100 (-60 °C – 250 °C) / Ni1000 TK6180 (-80 °C – 320 °C) / Ohm (10.0 Ω – 1200.0 Ω) / Ohm (10.0 Ω – 5000.0 Ω)	
Connection	2-wire	Two-wire connection
	3-wire*	Three-wire connection
State-Bits	OFF*	State bits are not mapped
	ON	State bits are mapped to the lower three bits of the output value: Bit 0:overrun. Bit is set if measuring value runs out of range. Bit 1:error. Bit is set if the module detects an error in internal functions or a shortcut at the input. Bit 2: 0
Watchdog Timer	OFF	Watchdog timer not active
	ON*	Watchdog timer active. If no data are exchanged with the buscoupler for 100 ms, the green LEDs will turn off.
Amount Sign	OFF*	Two's complement indication
	ON	Amount/Sign indication
Filter Constants	12.5 Hz – 500 ms / 25 Hz – 250 ms* / 50 Hz – 125 ms / 60 Hz – 110 ms / 100 Hz – 65 ms	
Overrange Protection	OFF	The output value is not limited
	ON*	If the temperature exceeds 850°C, the status bits are set and the output value is limited to 850°C
User Scaling	OFF*	User scaling not active
	ON	User scaling active
WAGO Scaling	OFF	WAGO scaling not active
	ON*	WAGO scaling active

* default settings

In **WAGO-I/O-CHECK 2**, the following input boxes allow you to set the offset and gain values of the user and manufacturer scaling.

Input box	...	Offset	Gain
User Scaling	...	0x0000	0x0100
WAGO Scaling	...	0x0000	0x00A0

The following input boxes are available in **WAGO-I/O-CHECK 2** for hardware calibration.

Input box	Settings
Offset	0xECF0
Gain	0x2700
2-wire-offset	0x0180



Further information

You can find detailed information on parameterizing this module in the **WAGO-I/O-CHECK 2** manual or on the Internet at <http://www.wago.com>.

2.1.3 750-461/020-000 [2 AI NTC 20kOhm]

2 Channel Analog Input Module for NTC 20kOhm RTDs,
2-wire connection

2.1.3.1 View

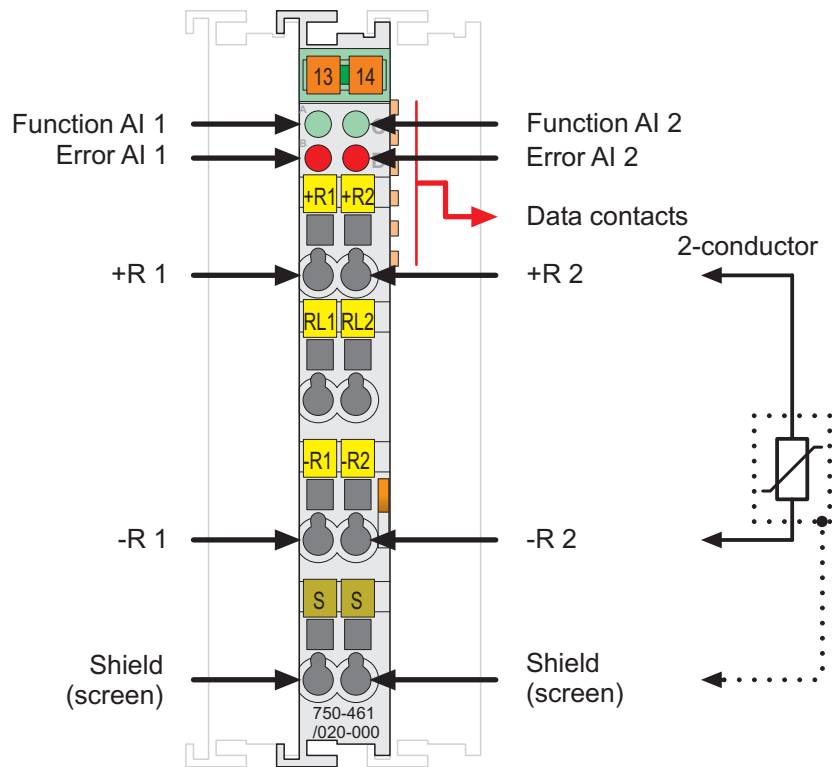

Fig. 2.1.3-1: 2-2-Channel Analog Input Module 750-461/020-000

g046103e

2.1.3.2 Description

The analog input module 750-461/020-000 evaluates NTC 20kOhm resistance Temperature Devices, RTDs.

The resistance value is converted to a temperature. A microprocessor within the module is used for converting and linearizing the measured resistance value into a numeric value proportional to the temperature of the selected resistance sensor.

The analog input module is a 2-conductor device and has 2 input channels. Two devices may be directly connected to the module.

The shield (screen) is directly connected to the DIN rail. A capacitive connection is made automatically when snapped onto the DIN rail.

An optocoupler is used for electrical isolation between the bus and the field side.

The operational readiness and trouble-free internal data bus communication of the channels are indicated via a green function LED. A broken wire, short-circuit or overrange are indicated by a red error LED per channel.

After the error has been corrected, the module needs up to 4 seconds to output a correct measured value.

Any configuration of the input modules is possible when designing the fieldbus node. Grouping of module types is not necessary.



Attention

This module has no power contacts. For field supply to downstream I/O modules, a supply module will be needed.

The analog input module can be used with all couplers/controllers of the WAGO-I/O-SYSTEM 750 (except for the economy types 750-320, -323, -324 and -327).

2.1.3.3 Display Elements

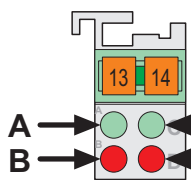



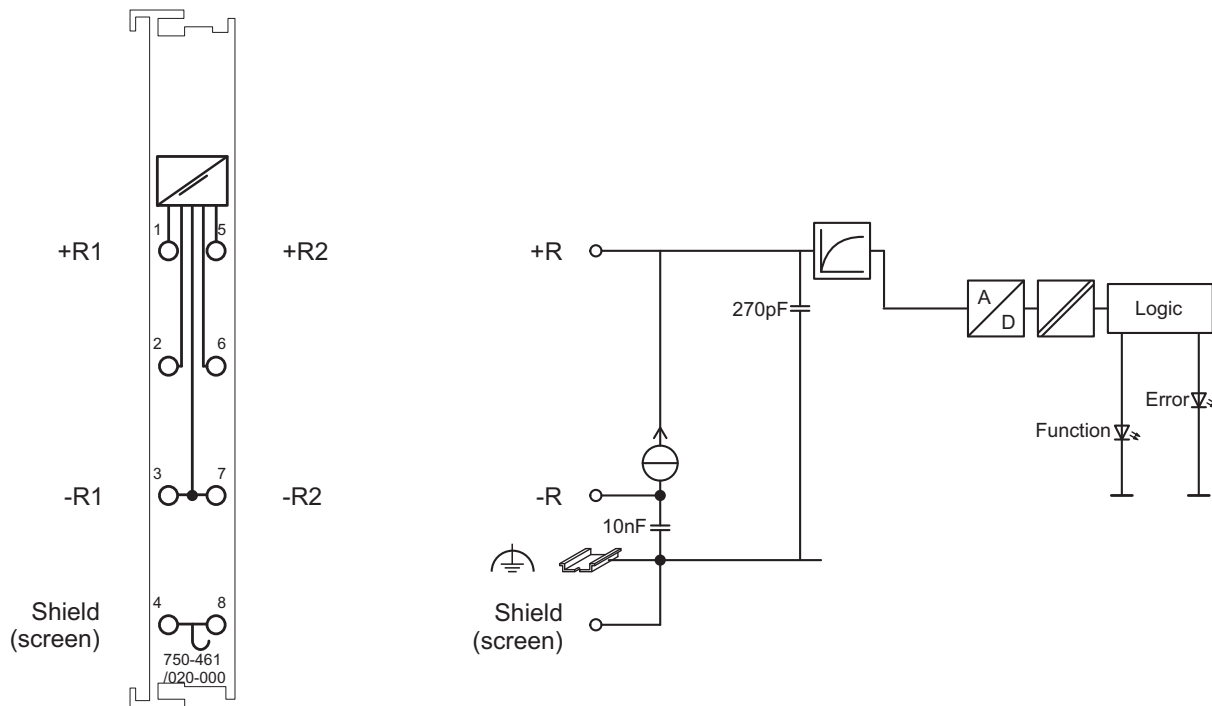

LED	Channel	State	Function
A green	1	off	No operational readiness or the internal data bus communication is interrupted
		on	Operational readiness and trouble-free internal data bus communication
off		Normal operation	
on		Overrange/underflow of the admissible measuring range, broken wire	
B red	2	off	No operational readiness or the internal data bus communication is interrupted
		on	Operational readiness and trouble-free internal data bus communication
off		Normal operation	
on		Overrange/underflow of the admissible measuring range, broken wire	
C green			
D red			

Fig. 2.1.3-2:
 Display elements
 g045202x

2.1.3.4 Schematic Diagram



2.1.3.5 Technical Data

Module Specific Data		
Number of inputs	2	
Voltage supply	via system voltage DC /DC	
Current consumption _{max.} (internal)	65 mA	
Sensor types	NTC 20kOhm	
Sensor connection	2-wire	
Temperature range	-30 °C ... +130 °C	
Resolution	0,1 °C	
Conversion time	320 ms (per channel)	
Response delay _{max.} (time from starting or connecting the sensor to the first proper measured value)	4 s	
Measuring error (The specified accurancys apply to a supply line resistance of $R_L < 1 \text{ Ohm}$)	<± 1,0 K in the range of -30 °C ... +50 °C (<± 0,5 K at 25 °C) <± 2,0 K in the range of +50 °C ... +100 °C <± 3,0 K in the range of +100 °C ... +130 °C	
Temperature coefficient	<± 0,002 % /K of full scale value	
Isolation	400 V (system/supply)	
Measured current _{typ.}	0,05 mA at 25 °C	
Bit width	2 x 16 bits data 2 x 8 bits Control/Status (option)	
Dimensions (mm) W x H x L	12 x 64* x 100 * from upper edge of 35 DIN rail	
Weight	ca. 55 g	
Standards and Regulations (cf. Chapter 2.2 of the Coupler/Controller Manual)		
EMC-Immunity to interference (CE)	acc. to EN 61000-6-2 (01)	
EMC-Emission of interference (CE)	acc. to EN 61000-6-3 (01)	
Approvals (cf. Chapter 2.2 of the Coupler/Controller Manual)		
	cUL _{US} (UL508)	
	Conformity Marking	
	DEMKO (08 ATEX 142851X)	I M2/ II 3 GD Ex nA IIC T4
	cUL _{US} (ANSI/ISA 12.12.01)	Class I Div 2 ABCD T4



More Information

Detailed references to the approvals are listed in the document "Overview Approvals WAGO-I/O-SYSTEM 750", which You can find on the CD ROM ELECTRONICC Tools and Docs (Item-No.: 0888-0412-0001-0101) or in the Internet under: <http://www.wago.com> → Service → Downloads → Documentation → WAGO-I/O-SYSTEM 750 → System Description.

2.1.3.6 Process Image

Some fieldbus systems can process input channel status information by means of a status byte.

This status byte can be displayed via the WAGO-I/O-CHECK 2 start-up and diagnostic tool. However, processing via the coupler / controller is optional, which means that accessing or parsing the status information depends on the fieldbus system.



Attention

The representation of the process data of some I/O modules or their variations in the process image depends on the fieldbus coupler/-controller used. Please take this information as well as the particular design of the respective control/status bytes from the section "Fieldbus Specific Design of the Process Data" included in the description concerning the process image of the corresponding coupler/controller.

The analog input modules 750-461/020-000 transmit 16-bit measured values per channel as well as 8 optional status bits to the coupler/controller.

To evaluate the NTC 20kOhm resistance sensors the measured values of the resistance are converted and sent as temperature values.

All temperature values are represented in a standard numeric format. The possible numerical range matches the defined temperature range of the sensors from -30 °C to +130 °C.

In the NTC 20kOhm setting, the temperature values of the sensors are represented with a resolution of 1 digit per 0.1 °C within a word (16 bits). Thus, 0 °C corresponds to the numeric value 0x0000 and 100 °C to 0x03E8 (dec. 1000).

Temperature values below 0 °C are represented in two's complement binary form.

750-461/020-000						
Tem- perature °C	Resis- tance kΩ	Numerical value ¹⁾			Status- byte Hex.	LED Error AI 1, 2
		binary	hex.	dec.		
<ca -30.0	>414.70	'0010.0001.0011.0100'	0x2134	8500	0x42	on
-30.0	414.70	'1111.1110.1101.0100'	0xFED4	-300	0x00	off
0.0	70.20	'0000.0000.0000.0000'	0x0000	0	0x00	off
25.0	20.00	'0000.0000.1111.1010'	0x00FA	250	0x00	off
50.0	6.72	'0000.0001.1111.0100'	0x01F4	500	0x00	off
100.0	1.12	'0000.0011.1110.1000'	0x03E8	1000	0x00	off
130.0	0.46	'0000.0101.0001.0100'	0x0514	1300	0x00	off
>ca 130.0	< 0.46	'1000.0000.0000.0001'	0x8001	-32767	0x41	on

¹⁾ Temperature values below 0 °C are represented in two's complement binary form.

The measured value can exceed the range from decimal -300 to 1300 until the limitation applies.

□ Use in Hazardous Environments

The WAGO-I/O-SYSTEM 750 (electrical equipment) is designed for use in Zone 2 hazardous areas.

The following sections include both the general identification of components (devices) and the installation regulations to be observed. The individual subsections of the "Installation Regulations" section must be taken into account if the I/O module has the required approval or is subject to the range of application of the ATEX directive.

2.2 Identification

2.2.1 For Europe according to CENELEC and IEC

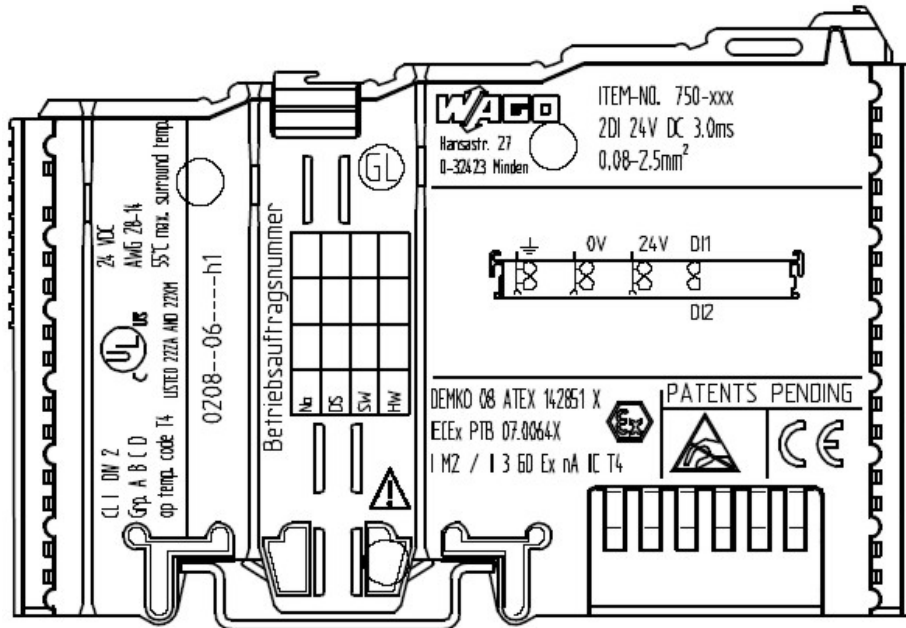

Fig. 2.2.1-1: Example for lateral labeling of bus modules (750-400, 2 channel digital input module 24 V DC)

p01xx03x

DEMKO 08 ATEX 142851 X
IECEX PTB 07.0064X
I M2 / II 3 GD Ex nA IIC T4

Fig. 2.2.1-2: Printing on text detail in accordance with CENELEC and IEC

p01xx04x

Tab. 0-1: Description of Printing on

Printing on Text	Description
DEMKO 08 ATEX 142851 X IECEX PTB 07.0064X	Approval body and/or number of the examination certificate
I M2 / II 3 GD	Device group and Unit category
Ex nA	Type of ignition and extended identification
IIC	Device group
T4	Temperature class

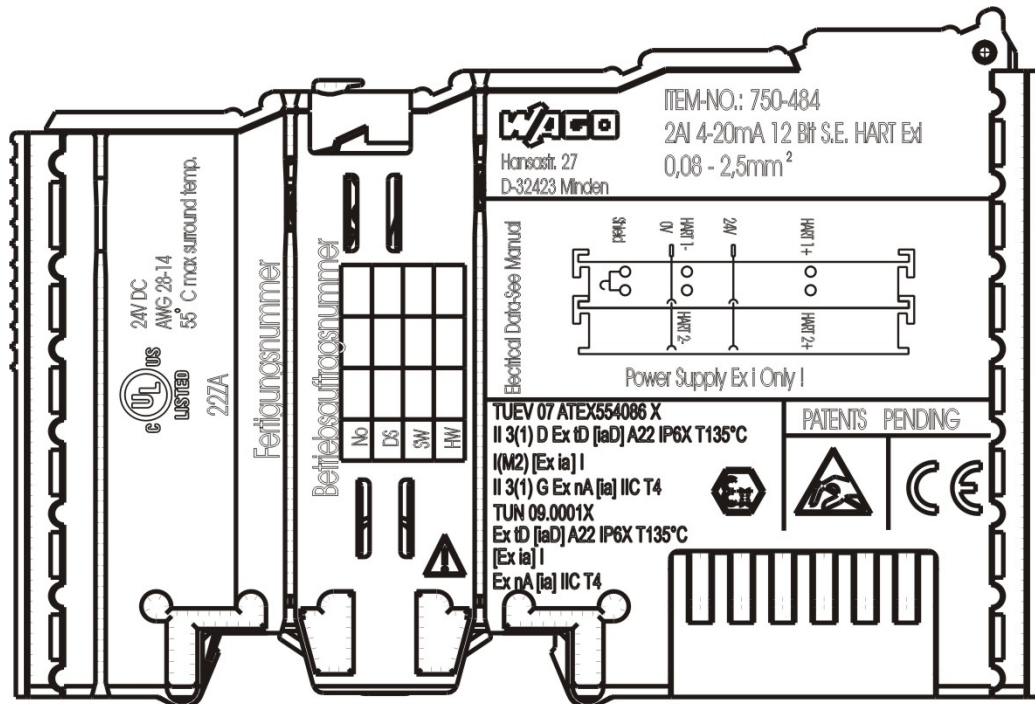

Figure 1: Example of side marking of Ex i and IEC Ex i approved I/O modules

TUEV 07 ATEX554086 X
II 3(1) D Ex tD [IaD] A22 IP6X T135°C
I(M2) [Ex ia] I
II 3(1) G Ex nA [Ia] IIC T4
TUN 09.0001X
Ex tD [IaD] A22 IP6X T135°C
[Ex ia] I
Ex nA [Ia] IIC T4



Figure 2: Inscription text detail acc. CENELEC and IEC

Table 1: Description of the inscription

Inscription text	Description
TÜV 07 ATEX 554086 X TUN 09.0001X	Approving authority or certificate numbers
Dust	
II	Device group: All except mining
3(1)D	Device category: Zone 22 device (Zone 20 subunit)
Ex	Explosion protection mark
tD	Protection by enclosure
[iaD]	Approved in accordance with "Dust intrinsic safety" standard
A22	Surface temperature determined according to Procedure A, use in Zone 22
IP6X	Dust-tight (totally protected against dust)
T 135°C	Max. surface temp. of the enclosure (no dust bin)
Mining	
I	Device group: Mining
(M2)	Device category: High degree of safety
[Ex ia]	Explosion protection: Mark with category of type of protection intrinsic safety: Even safe when two errors occur
I	Device group: Mining
Gases	
II	Device group: All except mining
3(1)G	Device category: Zone 2 device (Zone 0 subunit)
Ex	Explosion protection mark
nA	Type of protection: Non-sparking operating equipment
[ia]	Category of type of protection intrinsic safety: Even safe when two errors occur
IIC	Explosion Group
T4	Temperature class: Max. surface temperature 135°C

2.2.2 For America according to NEC 500

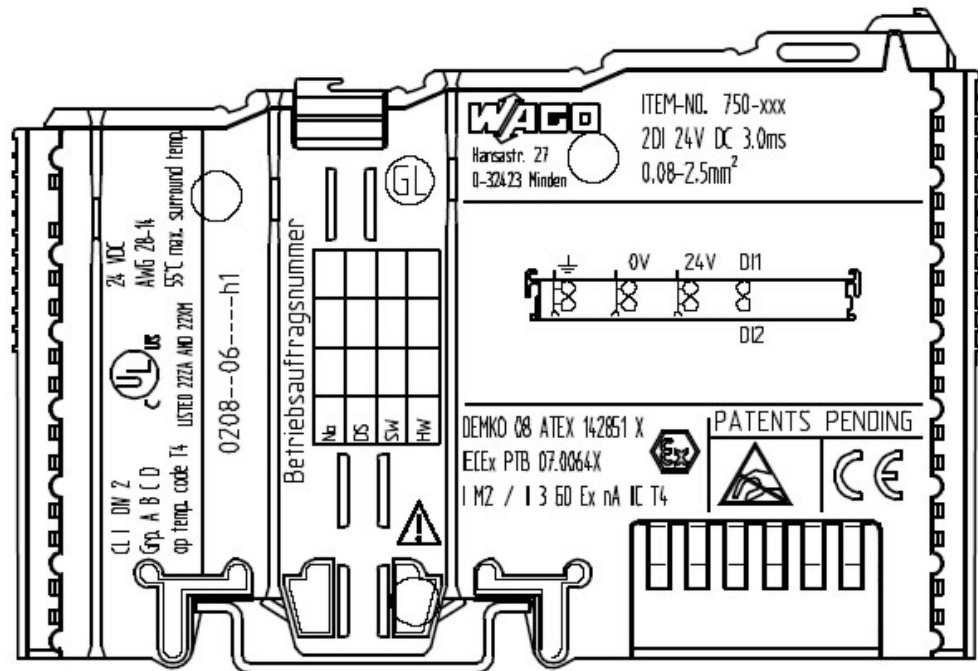

Fig. 2.2.2-3: Example for lateral labeling of bus modules (750-400, 2 channel digital input module 24 V DC)

p01xx03x



Fig. 2.2.2-4: Printing on text detail in accordance with CENELEC and IEC

p01xx05x

Tab. 0-2: Description of Printing on

Printing on Text	Description
CL 1	Explosion protection group (condition of use category)
DIV 2	Area of application (zone)
Grp. ABCD	Explosion group (gas group)
Op temp. code T4	Temperature class

2.3 Installation Regulations

In the **Federal Republic of Germany**, various national regulations for the installation in explosive areas must be taken into consideration. The basis for this forms the working reliability regulation, which is the national conversion of the European guideline 99/92/E6. They complemented by the installation regulation EN 60079-14. The following are excerpts from additional VDE regulations:

Tab. 0-3: VDE Installation Regulations in Germany

Standard	Installation Regulations
DIN VDE 0100	Installation in power plants with rated voltages up to 1000 V
DIN VDE 0101	Installation in power plants with rated voltages above 1 kV
DIN VDE 0800	Installation and operation in telecommunication plants including information processing equipment
DIN VDE 0185	lightning protection systems

The **USA** and **Canada** have their own regulations. The following are excerpts from these regulations:

Tab. 0-4: Installation Regulations in USA and Canada

Standard	Installation Regulations
NFPA 70	National Electrical Code Art. 500 Hazardous Locations
ANSI/ISA-RP 12.6-1987	Recommended Practice
C22.1	Canadian Electrical Code



Warning

When using the **WAGO-I/O SYSTEM 750** (electrical operation) with Ex approval, the following points are mandatory:

2.3.1 Special Conditions for Safe Operation of the ATEX and IEC Ex (acc. DEMKO 08 ATEX 142851X and IECEx PTB 07.0064)

The fieldbus-independent I/O modules of the WAGO-I/O-SYSTEMs 750-.../...-...
Must be installed in an environment with degree of pollution 2 or better. In the final
application, the I/O modules must be mounted in an enclosure with IP 54 degree of
protection at a minimum with the following exceptions:

- I/O modules 750-440, 750-609 and 750-611 must be installed in an IP 64
minimum enclosure.
- I/O module 750-540 must be installed in an IP 64 minimum enclosure for 230
V AC applications.
- I/O module 750-440 may be used up to max. 120 V AC.

When used in the presence of combustible dust, all devices and the enclosure shall be
fully tested and assessed in compliance with the requirements of IEC 61241-0:2004
and IEC 61241-1:2004.

I/O modules fieldbus plugs or fuses may only be installed, added, removed or
replaced when the system and field supply is switched off or the area exhibits no
explosive atmosphere.

DIP switches, coding switches and potentiometers that are connected to the
I/O module may only be operated if an explosive atmosphere can be ruled out.

I/O module 750-642 may only be used in conjunction with antenna 758-910 with a
max. cable length of 2.5 m.

To exceed the rated voltage no more than 40%, the supply connections must have
transient protection.

The permissible ambient temperature range is 0 °C to +55 °C.

2.3.2 Special conditions for safe use (ATEX Certificate TÜV 07 ATEX 554086 X)

1. For use as Gc- or Dc-apparatus (in zone 2 or 22) the fieldbus independent I/O modules WAGO-I/O-SYSTEM 750-*** shall be erected in an enclosure that fulfils the requirements of the applicable standards (see the marking) EN 60079-0, EN 60079-11, EN 60079-15, EN 61241-0 and EN 61241-1.
For use as group I, electrical apparatus M2, the apparatus shall be erected in an enclosure that ensures a sufficient protection according to EN 60079-0 and EN 60079-1 and the degree of protection IP64. The compliance of these requirements and the correct installation into an enclosure or a control cabinet of the devices shall be certified by an ExNB.
2. If the interface circuits are operated without the fieldbus coupler station type 750-3../...-... (DEMKO 08 ATEX 142851 X) measures must be taken outside of the device so that the rating voltage is not being exceeded of more than 40% because of transient disturbances.
3. DIP-switches, binary-switches and potentiometers, connected to the module may only be actuated when explosive atmosphere can be excluded.
4. The connecting and disconnecting of the non-intrinsically safe circuits is only permitted during installation, for maintenance or for repair purposes.
The temporal coincidence of explosion hazardous atmosphere and installation, maintenance resp. repair purposes shall be excluded.
5. For types 750-606, 750-625/000-001, 750-487/003-000, 750-484, the following must be taken into account: The interface circuits must be limited to overvoltage category I/II/III (electrical circuits without power supply/electrical circuits with power supply) as defined in EN 60664-1.
6. For the type 750-601 the following shall be considered: Do not remove or replace the fuse when the apparatus is energized.
7. The ambient temperature range is: $0^{\circ}\text{C} \leq T_a \leq +55^{\circ}\text{C}$ (for extended details please note certificate).

2.3.3 Special conditions for safe use (IEC-Ex Certificate TUN 09.0001 X)

1. For use as Dc- or Gc-apparatus (in zone 2 or 22) the fieldbus independent I/O modules WAGO-I/O-SYSTEM 750-*** shall be erected in an enclosure that fulfils the requirements of the applicable standards (see the marking) IEC 60079-0, IEC 60079-11, IEC 60079-15, IEC 61241-0 and IEC 61241-1. For use as group I, electrical apparatus M2, the apparatus shall be erected in an enclosure that ensures a sufficient protection according to IEC 60079-0 and IEC 60079-1 and the degree of protection IP64. The compliance of these requirements and the correct installation into an enclosure or a control cabinet of the devices shall be certified by an ExCB.
2. Measures have to be taken outside of the device that the rating voltage is not being exceeded of more than 40% because of transient disturbances.
3. DIP-switches, binary-switches and potentiometers, connected to the module may only be actuated when explosive atmosphere can be excluded
4. The connecting and disconnecting of the non-intrinsically safe circuits is only permitted during installation, for maintenance or for repair purposes. The temporal coincidence of explosion hazardous atmosphere and installation, maintenance resp. repair purposes shall be excluded.
5. For the types 750-606, 750-625/000-001, 750-487/003-000, 750-484 the following shall be considered: The interface circuits shall be limited to overvoltage category I/II/III (non mains/mains circuits) as defined in IEC 60664-1.
6. For the type 750-601 the following shall be considered: Do not remove or replace the fuse when the apparatus is energized.
7. The ambient temperature range is: $0^{\circ}\text{C} \leq T_a \leq +55^{\circ}\text{C}$ (for extended details please note certificate).

2.3.4 ANSI/ISA 12.12.01

This equipment is suitable for use in Class I, Division 2, Groups A, B, C, D or non-hazardous locations only.



Warning

Explosion hazard - substitution of components may impair suitability for Class I, Div. 2.



Warning

Do not disconnect equipment unless power has been switched off or the area is known to be non-hazardous.

When a fuse is provided, the following marking shall be provided:
"A switch suitable for the location where the equipment is installed shall be provided to remove the power from the fuse."
The switch need not be integrated in the equipment.

For devices with Ethernet connectors:
"Only for use in LAN, not for connection to telecommunication circuits."



Warning

Use Module 750-642 only with antenna module 758-910.



WAGO Kontakttechnik GmbH & Co. KG
Postfach 2880 • D-32385 Minden
Hansastraße 27 • D-32423 Minden
Phone: 05 71/8 87 – 0
Fax: 05 71/8 87 – 1 69
E-Mail: info@wago.com

Internet: <http://www.wago.com>
