

30 A - 800 V TO-220AB insulated H-series Snubberless™ Triac

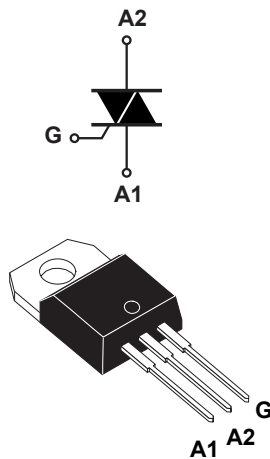

TO-220AB insulated

Features

- 30 A high current Triac
- 800 V symmetrical blocking voltage
- 150 °C maximum junction temperature T_j
- Three triggering quadrants
- High noise immunity, static dV / dt
- Robust dynamic turn-off commutation (di/dt)_c
- ECOPACK®2 compliant component
- Comply with UL1557 insulation: 2.5 kV
 - Reference file: E81734

Applications

- Home automation Smart AC plug
- Water heater, room heater and coffee machine
- AC Induction and Universal Motor control
- Inrush current limiter in AC DC rectifiers
- Lighting and automation I/O control
- General purpose AC line load control

Description

Specifically designed to operate at 800 V and 150 °C, the **T3035H-8I** Triac provides an enhanced thermal management: this 30 A triac is the right choice for a compact drive of heavy AC loads and enables the heatsink size reduction.

Based on the ST Snubberless™ high temperature technology, it offers higher specified turn off commutation and noise immunity levels up to the T_j max.

The **T3035H-8I** safely optimizes the control of the hardest universal motors, heaters and inductive loads for industrial control and home appliances.

By using an internal ceramic pad, it provides a recognized voltage insulation, rated at 2500 V_{RMS} .

Snubberless™ is a trademark of STMicroelectronics.

Product status link	
T3035H-8I	
Product summary	
$I_{T(RMS)}$	30 A
V_{DRM}/V_{RRM}	800 V
V_{DSM}/V_{RSM}	900 V
I_{GT}	35 mA

1 Characteristics

Table 1. Absolute maximum ratings (limiting values)

Symbol	Parameter	Value	Unit
$I_{T(RMS)}$	RMS on-state current (full sine wave)	$T_c = 91\text{ °C}$	30 A
I_{TSM}	Non repetitive surge peak on-state current (full cycle, T_j initial = 25 °C)	$t = 16.7\text{ ms}$	283
		$t = 20\text{ ms}$	270
I^2t	I^2t value for fusing	$t_p = 10\text{ ms}$	482 A ² s
di/dt	Critical rate of rise of on-state current, $I_G = 2 \times I_{GT}$, $t_r \leq 100\text{ ns}$, $f = 100\text{ Hz}$	$T_j = 25\text{ °C}$	100 A/ μ s
V_{DRM}/V_{RRM}	Repetitive peak off-state voltage		800 V
V_{DSM}/V_{RSM}	Non Repetitive peak off-state voltage	$t_p = 10\text{ ms}$, $T_j = 25\text{ °C}$	900 V
I_{GM}	Peak gate current	$t_p = 20\text{ }\mu\text{s}$, $T_j = 150\text{ °C}$	4 A
P_{GM}	Maximum gate power dissipation		5 W
$P_{G(AV)}$	Average gate power dissipation	$T_j = 150\text{ °C}$	1 W
T_{stg}	Storage temperature range		-40 to +150 °C
T_j	Operating junction temperature range		-40 to +150 °C
T_L	Maximum lead temperature for soldering during 10 s		260 °C
V_{INS}	Insulation RMS voltage, 1 minute		2.5 kV

Table 2. Electrical characteristics ($T_j = 25\text{ °C}$, unless otherwise specified)

Symbol	Test conditions	Quadrants		Value	Unit
I_{GT}	$V_D = 12\text{ V}$, $R_L = 30\text{ }\Omega$	I - II - III	Min.	5	mA
	$V_D = 12\text{ V}$, $R_L = 30\text{ }\Omega$	I - II - III	Max.	35	mA
V_{GT}	$V_D = 12\text{ V}$, $R_L = 30\text{ }\Omega$	I - II - III	Max.	1.3	V
V_{GD}	$V_D = V_{DRM}$, $R_L = 3.3\text{ k}\Omega$	I - II - III	Max.	0.15	V
	$T_j = 150\text{ °C}$				
I_L	$I_G = 1.2 \times I_{GT}$	I - III	Max.	75	mA
		II	Max.	90	mA
$I_H^{(1)}$	$I_T = 500\text{ mA}$, gate open		Max.	60	mA
$dV/dt^{(1)}$	$V_D = 536\text{ V}$, gate open	$T_j = 150\text{ °C}$	Min.	1500	V/ μ s
$(di/dt)_c^{(1)}$	Without snubber network	$T_j = 150\text{ °C}$	Min.	25	A/ms

1. For both polarities of A2 referenced to A1.

Table 3. Static characteristics

Symbol	Test conditions	T _j		Value	Unit
V _{TM} ⁽¹⁾	I _T = 42 A, t _p = 380 μs	25 °C	Max.	1.55	V
V _{TO} ⁽¹⁾	Threshold voltage	150 °C	Max.	0.83	V
R _D ⁽¹⁾	Dynamic resistance	150 °C	Max.	16	mΩ
I _{DRM} /I _{RDM}	V _{DRM} = V _{RDM} = 800 V	25 °C	Max.	5	μA
		150 °C		8.5	mA
	V _{DRM} = V _{RDM} = 400 V, peak voltage	150 °C	Max.	3.6	mA

1. For both polarities of A2 referenced to A1.

Table 4. Thermal resistance

Symbol	Parameter		Value	Unit
R _{th(j-c)}	Junction to case (AC)	Max.	1.6	°C/W
R _{th(j-a)}	Junction to ambient	Typ.	60	°C/W

1.1 Characteristics (curves)

Figure 1. Maximum power dissipation versus on-state RMS current

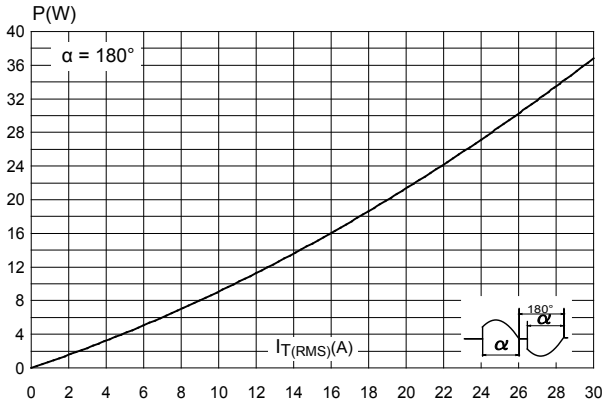

Figure 2. On-state RMS current versus case temperature

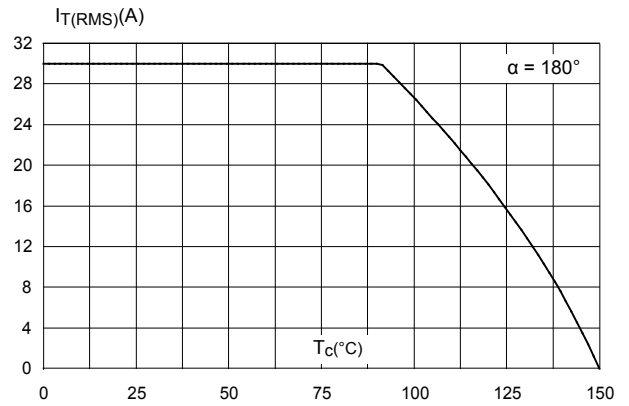

Figure 3. On-state RMS current versus ambient temperature (free air convection)

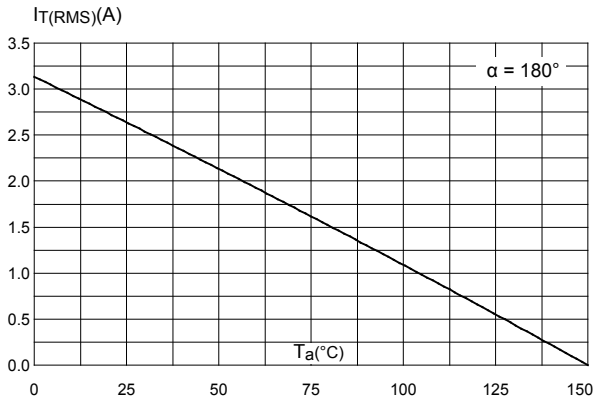

Figure 4. Relative variation of thermal impedance versus pulse duration

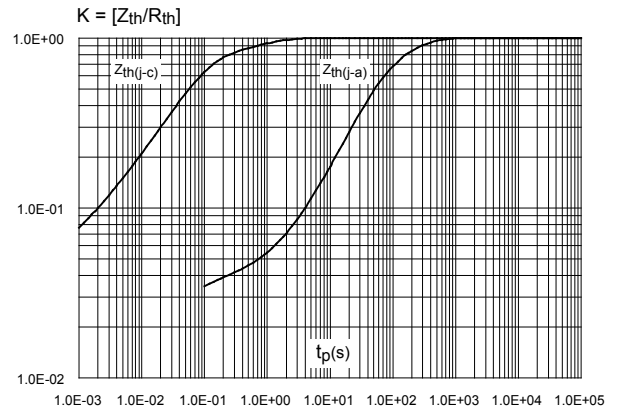

Figure 5. Relative variation of gate trigger voltage and current versus junction temperature (typical values)

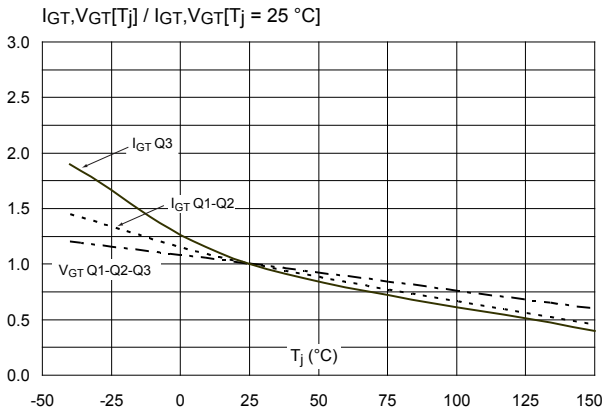

Figure 6. Relative variation of holding current and latching current versus junction temperature (typical values)

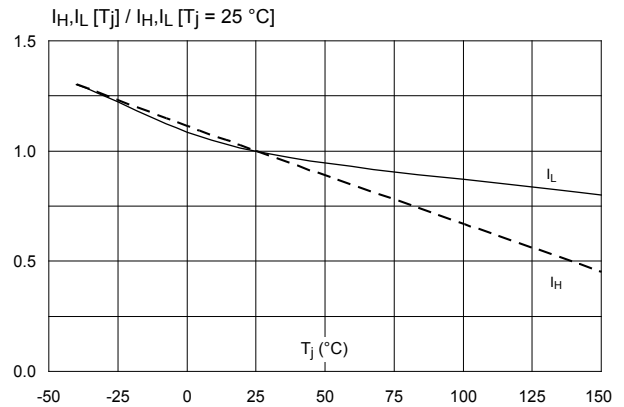

Figure 7. Surge peak on-state current versus number of cycles

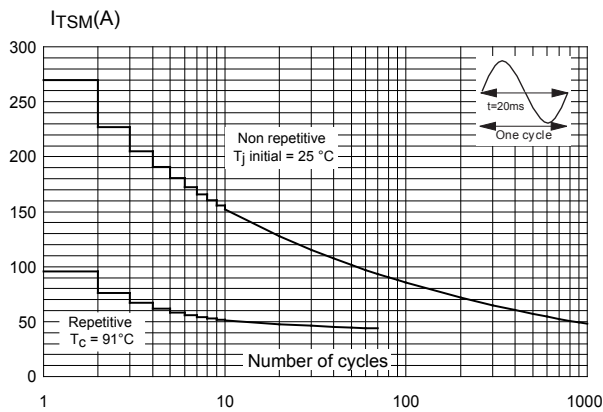

Figure 8. On-state characteristics (maximum values)

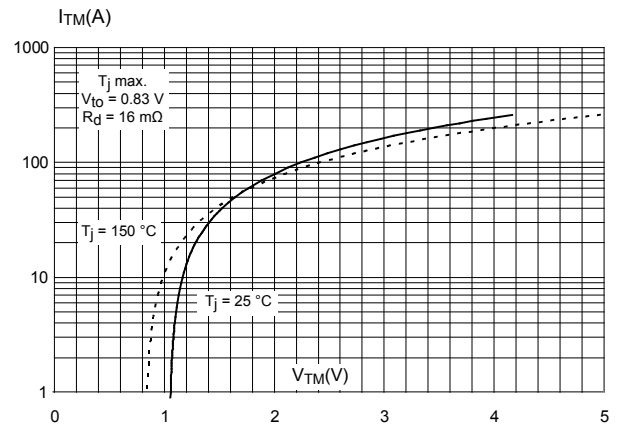

Figure 9. Relative variation of static dV/dt immunity versus junction temperature

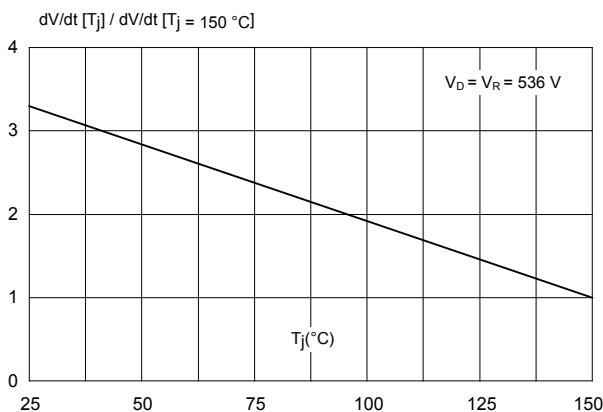

Figure 10. Relative variation of critical rate of decrease of main current versus junction temperature

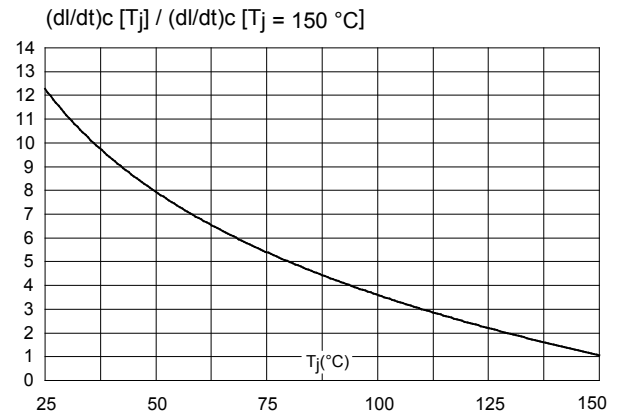

Figure 11. Relative variation of leakage current versus junction temperature for different values of blocking voltage

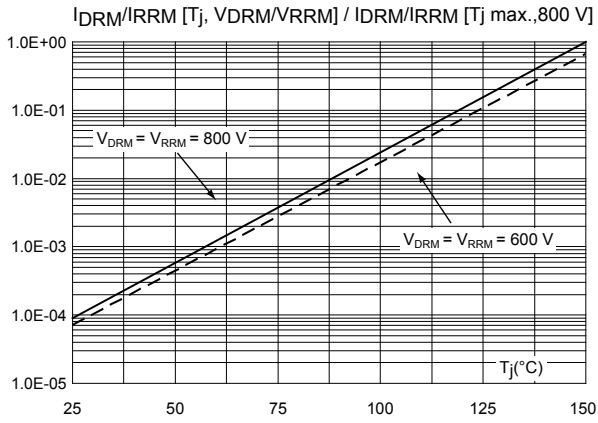
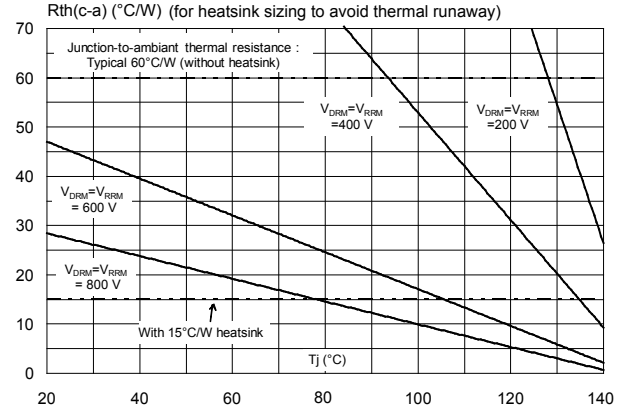

Figure 12. Recommended maximum case-to-ambient thermal resistance versus ambient temperature for different peak off-state voltages



2 Package information

In order to meet environmental requirements, ST offers these devices in different grades of ECOPACK® packages, depending on their level of environmental compliance. ECOPACK® specifications, grade definitions and product status are available at: www.st.com. ECOPACK® is an ST trademark.

2.1 TO-220AB insulated package information

- Epoxy resin is halogen free and meets UL94 flammability standard, level V0
- Lead-free plating package leads
- Recommended torque: 0.4 to 0.6 N·m

Figure 13. TO-220AB insulated package outline

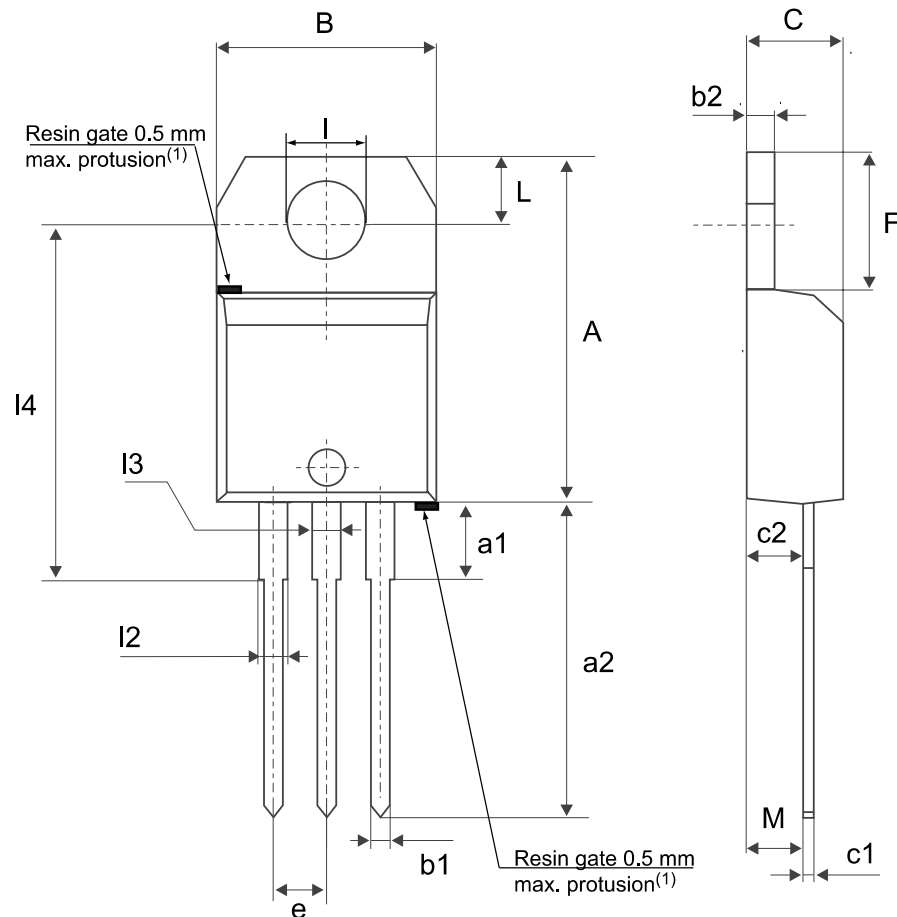

(1) Resin gate position accepted in one of the two positions or in the symmetrical opposites.

Table 5. TO-220AB insulated package mechanical data

Ref.	Dimensions					
	Millimeters			Inches ⁽¹⁾		
	Min.	Typ.	Max.	Min.	Typ.	Max.
A	15.20		15.90	0.5984		0.6260
a1		3.75			0.1476	
a2	13.00		14.00	0.5118		0.5512
B	10.00		10.40	0.3937		0.4094
b1	0.61		0.88	0.0240		0.0346
b2	1.23		1.32	0.0484		0.0520
C	4.40		4.60	0.1732		0.1811
c1	0.49		0.70	0.0193		0.0276
c2	2.40		2.72	0.0945		0.1071
e	2.40		2.70	0.0945		0.1063
F	6.20		6.60	0.2441		0.2598
I	3.73		3.88	0.1469		0.1528
L	2.65		2.95	0.1043		0.1161
I2	1.14		1.70	0.0449		0.0669
I3	1.14		1.70	0.0449		0.0669
I4	15.80	16.40	16.80	0.6220	0.6457	0.6614
M		2.6			0.1024	

1. Inch dimensions are for reference only.

3 Ordering information

Figure 14. Ordering information scheme

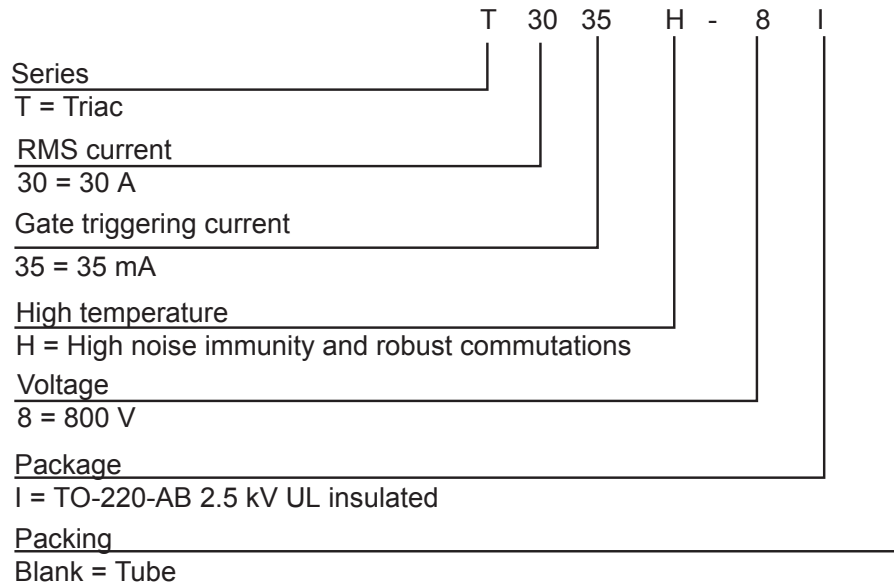

Table 6. Ordering information

Marking	Package	Weight	Base qty.	Delivery mode
T3035H-8I	TO-220AB Ins.	2.3 g	50	Tube

Revision history

Table 7. Document revision history

Date	Version	Changes
27-Jul-2018	1	Initial release.

IMPORTANT NOTICE – PLEASE READ CAREFULLY

STMicroelectronics NV and its subsidiaries (“ST”) reserve the right to make changes, corrections, enhancements, modifications, and improvements to ST products and/or to this document at any time without notice. Purchasers should obtain the latest relevant information on ST products before placing orders. ST products are sold pursuant to ST’s terms and conditions of sale in place at the time of order acknowledgement.

Purchasers are solely responsible for the choice, selection, and use of ST products and ST assumes no liability for application assistance or the design of Purchasers’ products.

No license, express or implied, to any intellectual property right is granted by ST herein.

Resale of ST products with provisions different from the information set forth herein shall void any warranty granted by ST for such product.

ST and the ST logo are trademarks of ST. All other product or service names are the property of their respective owners.

Information in this document supersedes and replaces information previously supplied in any prior versions of this document.

© 2018 STMicroelectronics – All rights reserved