High Efficiency Small Packaged Step-up DC/DC Converter

No. EA-317-200604

OUTLINE

The RP402x is a high efficiency step-up DC/DC converter with synchronous rectifier. The device can start up with low voltage of typically 0.7 V which is ideal for the applications powered by either one-cell or two-cell alkaline, nickel-metal-hydrate (NiMH) or one-cell Lithium-ion (Li+) batteries.

Internally, the RP402x consists of an oscillator, a reference voltage unit with soft start, a chip enable circuit, an error amplifier, phase compensation circuits, a slope circuit, a PWM control circuit, a start-up circuit, a PWM/VFM mode control circuit, internal switches and protection circuits.

The RP402x is employing synchronous rectification for improving the efficiency or rectification by replacing diodes with built-in switching transistors. Using synchronous rectification not only increases circuit performance but also allows a design to reduce parts count.

The RP402x is available in either internally fixed output voltage type or adjustable output voltage type. The RP402xxxx is the internally fixed output voltage type. The RP402x00xx is the adjustable output voltage type, which allows output voltages that range from 1.8 V to 5.5 V via an external divider resistor.

The RP402x provides the forced PWM control and the PWM/VFM auto switching control. Either one of these can be selected by inputting a signal to the MODE pin. The forced PWM control switches at fixed frequency rate in low output current in order to reduce noise. Likewise, the PWM/VFM auto switching control automatically switches from PWM mode to VFM mode in low output current in order to achieve high efficiency. The RP402N is available in the PWM/VFM auto switching control. However, the RP402N is also available in the forced PWM control as a custom-designed IC⁽¹⁾.

The RP402x has a soft-start time of typically 0.5 ms.

The RP402x features the complete output disconnect shutdown option and the input-to-output bypass shutdown option. The RP402xxxxA/ B/ E/ F incorporates the complete output disconnect shutdown option, which allows the output to be disconnected from the input. The RP402xxxxC/ D/ G/ H incorporates the input-to-output bypass shutdown option, which allows the output to be connected to the input.

The RP402x is protected against damage by a short-current protection, an over-voltage lockout, an over voltage protection, an anti-ringing switch and a latch-type protection. An anti-ringing switch prevents the occurrence of noise when an inductor current reaches a discontinuous mode. The RP402x provides optional Latch function with current limit detection which can turn off the power in case the limit values are detected for a fixed time and current limit circuit controls peak inductor currents in every clock. The latch-type protection can be released by switching the CE pin from high to low while the power is turned on.

The RP402x is offered in a compact 5-pin SOT23-5 package or a 8-pin DFN(PL)2020-8 package.

⁽¹⁾ As for the custom-designed IC, please contact our sales representatives.

RP402x

No. EA-317-200604

FEATURES

- Low Voltage Start-up Typ. 0.7 V
- Input Voltage Range Fixed Output Voltage Type: 0.6 V to 4.8 V
Adjustable Output Voltage Type: 0.6 V to 4.6 V
- High Efficiency 94% (100 mA/ 5.0 V, $V_{IN} = 3.6$ V, 25°C)
90% (1 mA/ 5.0 V, $V_{IN} = 3.6$ V, 25°C)
- Output Current 800 mA: $V_{IN} = 3.6$ V, $V_{OUT} = 5.0$ V
- L_x Driver ON Resistance NMOS/ PMOS: 0.20 Ω ($V_{OUT} = 5.0$ V, 25°C)
- PWM Oscillator Frequency 1.2 MHz (Normal PWM), 1.0 MHz (Forced PWM)
- Output Voltage Range Fixed Output Voltage Type: 1.8 V to 5.5 V, 0.1 V step
Adjustable Output Voltage Type: 1.8 V to 5.5 V (recommended)
- OVLO Detector Threshold Typ. 5.1 V
- OVP Detector Threshold Typ. 6.0 V
- L_x Peak Current Limit Typ. 1.5 A
- Latch Protection Delay Time Typ. 3.3 ms (RP402Kxx1x, RP402Nxx1x)
Typ. 4.1 ms (RP402Kxx2x)
- Soft-start Time Typ. 0.5 ms
- EMI Suppression (Built-in Anti-ringing Switch) (RP402Kxx1x, RP402Nxx1x)
- Voltage Regulation at $V_{IN} > V_{OUT}$
- Zero Input Complete Shutdown at $V_{IN} = 0$ V
- Input-to-Output Bypass Shutdown Option at CE = L (RP402xxxxC/ D/ G/ H)
- Ceramic Capacitor Capable
- Package DFN(PL)2020-8, SOT23-5

APPLICATIONS

- MP3 Players, PDA
- Digital Still Cameras
- LCD Bias Supplies
- Portable Blood Pressure Meter
- Wireless Handset
- GPS
- USB-OTG
- HDMI

SELECTION GUIDE

The package type, the set output voltage, the PWM control type, the shutdown option, the MODE pin option, and the latch function are user-selectable options.

Selection Guide

Product Name	Package	Quantity per Reel	Pb Free	Halogen Free
RP402Kxx#-\$-TR	DFN(PL)2020-8	5,000 pcs	Yes	Yes
RP402Nxx#-\$-TR-FE	SOT-23-5	3,000 pcs	Yes	Yes

xx: Specify the set output voltage (V_{SET}).

00: Adjustable Output Voltage Type (1.8 V to 5.5 V, recommended voltage range)

xx: Fixed Output Voltage Type (1.8 V to 5.5 V, adjustable in 0.1 V step)

Please note: SOT-23-5 package is only available with fixed output voltage type.

#: Specify the PWM control type.

1: Normal PWM operation

2: Forced PWM operation

\$: Specify the combination of the shutdown option, the MODE pin option and the latch function.

Version	Shutdown Options at CE = L	MODE Pin	Latch Function
A	Complete Output Disconnect	Yes	Yes
B	Complete Output Disconnect	Yes	No
C	Input-to-Output Bypass	Yes	Yes
D	Input-to-Output Bypass	Yes	No
E	Complete Output Disconnect	No	Yes
F	Complete Output Disconnect	No	No
G	Input-to-Output Bypass	No	Yes
H	Input-to-Output Bypass	No	No

Please refer to *Selection Guide Table* on the next page for detailed information.

RP402x

No. EA-317-200604

Selection Guide Table

Package	Output Voltage Type	#	Shutdown Option at CE = L	MODE Pin Function		PWM Controlling Method	Latch Function
				MODE Pin	Power Controlling Method		
DFN(PL)2020-8	Fixed Output Voltage Type	1A	Complete Output Disconnect	Yes	"H": Normal PWM Control, "L": PWM/VFM Auto Switching Control	Normal PWM	Yes
		2A			"H": Forced PWM Control Note: "H" recommended	Forced PWM	
		1B			"H": Normal PWM Control, "L": PWM/VFM Auto Switching Control	Normal PWM	No
		2B			"H": Forced PWM Control Note: "H" recommended	Forced PWM	
	Adjustable Output Voltage Type	1C	Input-to-Output Bypass		"H": Normal PWM Control, "L": PWM/VFM Auto Switching Control	Normal PWM	Yes
		1D			"H": Normal PWM Control, "L": PWM/VFM Auto Switching Control	Normal PWM	No
	Adjustable Output Voltage Type	1A	Complete Output Disconnect		"H": Normal PWM Control, "L": PWM/VFM Auto Switching Control	Normal PWM	Yes
		2A			"H": Forced PWM Control Note: "H" recommended	Forced PWM	
		1B			"H": Normal PWM Control, "L": PWM/VFM Auto Switching Control	Normal PWM	No
		2B			"H": Forced PWM Control Note: "H" recommended	Forced PWM	
		1C	Input-to-Output Bypass		"H": Normal PWM Control, "L": PWM/VFM Auto Switching Control	Normal PWM	Yes
		1D			"H": Normal PWM Control, "L": PWM/VFM Auto Switching Control	Normal PWM	No
SOT-23-5	Fixed Output Voltage Type	1E	Complete Output Disconnect	No	PWM/VFM Auto Switching Control	Normal PWM	Yes
		1F			PWM/VFM Auto Switching Control	Normal PWM	No
		1G	Input-to-Output Bypass		PWM/VFM Auto Switching Control	Normal PWM	Yes
		1H			PWM/VFM Auto Switching Control	Normal PWM	No

BLOCK DIAGRAMS

*1 This Bypass Switch is included in the RP402KxxxC / D only.

*2 This Latch Timer is included in the RP402KxxxA / C only.

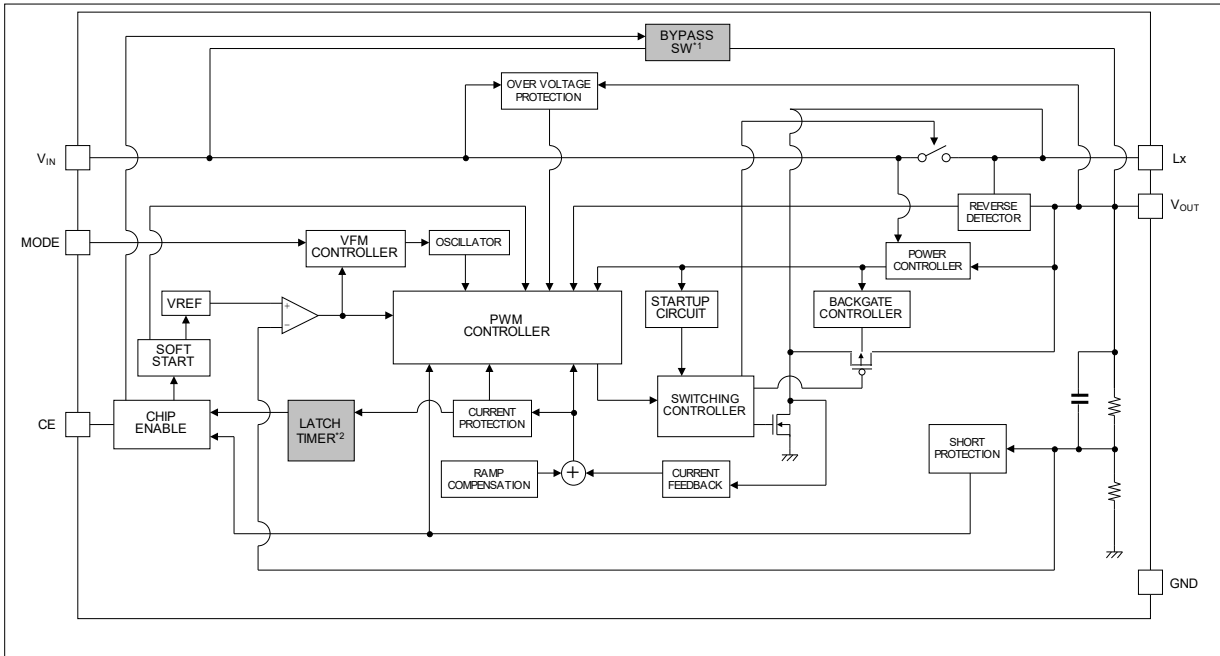

RP402Kxxxx Block Diagram

*1 This Bypass Switch is included in the RP402KxxxC / D only.

*2 This Latch Timer is included in the RP402KxxxA / C only.

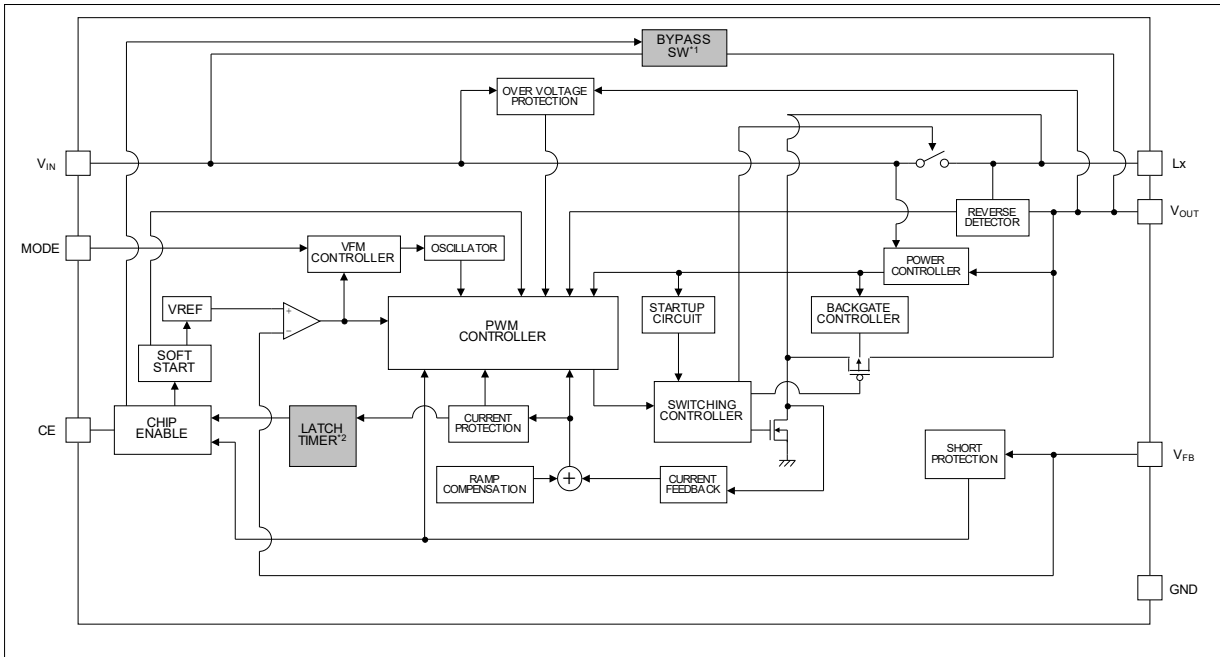

RP402K00xx Block Diagram

RP402x

No. EA-317-200604

¹ This Bypass Switch is included in the RP402NxxxG/ H only.
² This Latch Timer is included in the RP402NxxxE/ G only.

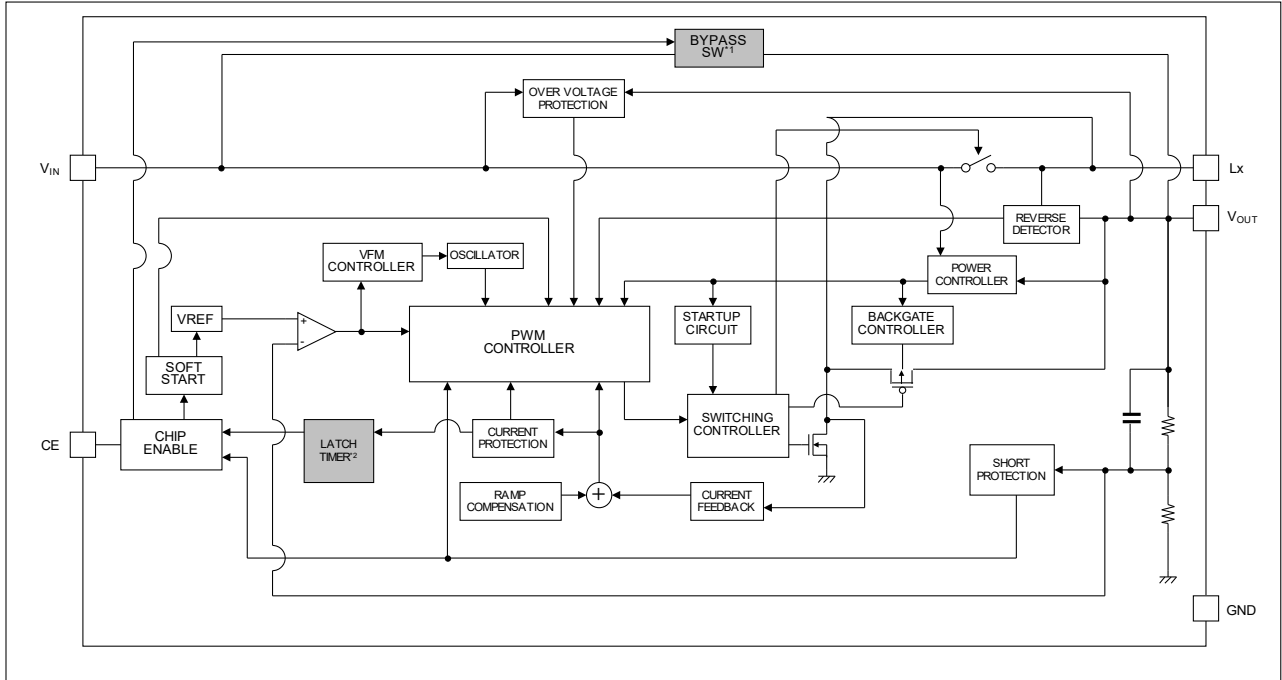

RP402Nxxxx Block Diagram

PIN DESCRIPTION

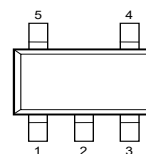
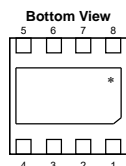
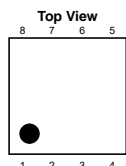

RP402K [DFN(PL)2020-8] Pin Configurations

RP402N (SOT-23-5) Pin Configurations

* The tab on the bottom of the package enhances thermal performance and is electrically connected to GND (substrate level). It is recommended that the tab be connected to the ground plane on the board, or otherwise be left floating.

RP402Kxxxx Pin Description

Pin No.	Symbol	Description
1	MODE	Mode Pin ⁽¹⁾
2	NC	No Connection
3	GND	Ground Pin
4	LX	Internal NMOS Switch Drain Pin
5	V _{OUT}	Output Pin
6	V _{IN}	Power Supply Pin
7	NC	No Connection
8	CE	Chip Enable Pin, Active-high

RP402K00xx Pin Description

Pin No.	Symbol	Description
1	MODE	MODE Pin ⁽¹⁾
2	NC	No Connection
3	GND	Ground Pin
4	LX	Internal NMOS Switch Drain Pin
5	V _{OUT}	Output Pin
6	V _{IN}	Power Supply Pin
7	V _{FB}	Feedback Input Pin for Setting Output Voltage
8	CE	Chip Enable Pin, Active-high

RP402Nxx1x Pin Description

Pin No.	Symbol	Description
1	LX	Internal NMOS Switch Drain Pin
2	GND	Ground Pin
3	CE	Chip Enable Pin, Active-high
4	V _{IN}	Power Supply Pin
5	V _{OUT}	Output Pin

⁽¹⁾ MODE Pin = "H" is recommended for RP402Kxx2x.

RP402x

No. EA-317-200604

ABSOLUTE MAXIMUM RATINGS

Absolute Maximum Ratings

Symbol	Parameter	Rating	Unit	
V_{IN}	V_{IN} Pin Voltage	-0.3 to 6.5	V	
V_{OUT}	V_{OUT} Pin Voltage	-0.3 to 7.0	V	
V_{LX}	L_X Pin Voltage	-0.3 to 6.5	V	
V_{CE}	CE Pin Voltage	-0.3 to 6.5	V	
V_{FB}	V_{FB} Pin Voltage (RP402K00xx only)	-0.3 to 6.5	V	
V_{MODE}	MODE Pin Voltage (RP402Kxxxx only)	-0.3 to 6.5	V	
P_D	Power Dissipation ⁽¹⁾ (JEDEC STD. 51-7)	DFN(PL)2020-8	1800	mW
		SOT-23-5	660	
T_j	Junction Temperature Range	-40 to 125	°C	
T_{stg}	Storage Temperature Range	-55 to 125	°C	

ABSOLUTE MAXIMUM RATINGS

Electronic and mechanical stress momentarily exceeded absolute maximum ratings may cause permanent damage and may degrade the life time and safety for both device and system using the device in the field. The functional operation at or over these absolute maximum ratings is not assured.

RECOMMENDED OPERATING CONDITIONS

Recommended Operating Conditions

Symbol	Parameter	Rating	Unit
V_{IN}	Input Voltage	0.6 to 4.8	V
T_a	Operating Temperature	-40 to 85	°C

RECOMMENDED OPERATING CONDITIONS

All of electronic equipment should be designed that the mounted semiconductor devices operate within the recommended operating conditions. The semiconductor devices cannot operate normally over the recommended operating conditions, even if they are used over such conditions by momentary electronic noise or surge. And the semiconductor devices may receive serious damage when they continue to operate over the recommended operating conditions.

⁽¹⁾ Refer to *POWER DISSIPATION* for detailed information.

ELECTRICAL CHARACTERISTICS

The specifications surrounded by are guaranteed by design engineering at $-40^{\circ}\text{C} \leq T_a \leq 85^{\circ}\text{C}$.

RP402xxxx Electrical Characteristics (Not applicable to RP402K00xx)

($T_a = 25^{\circ}\text{C}$)

Symbol	Parameter		Condition	Min.	Typ.	Max.	Unit
V_{START}	Start-up Voltage		$R_L = 5.5 \text{ k}\Omega$		0.7	0.8	V
V_{HOLD}	Hold-on Voltage after start-up ⁽¹⁾		$R_L = 5.5 \text{ k}\Omega$	0.6			V
V_{OVLO}	OVLO Voltage		-	4.8	5.1		V
V_{OVP}	OVP Voltage		-		6.0		V
I_{DD1}	Quiescent Current 1		$V_{\text{IN}} = V_{\text{SET}} - 0.4 \text{ V}$, $V_{\text{OUT}} = 0.95 \times V_{\text{SET}}$		1.6		mA
I_{DD2}	Quiescent Current 2 ⁽²⁾		$V_{\text{IN}} = V_{\text{SET}} - 0.4 \text{ V}$, $V_{\text{OUT}} = V_{\text{SET}} + 0.2 \text{ V}$		21	37	μA
Istandby	Standby Current	RP402xxxxA/ B/ E/ F	$V_{\text{IN}} = 4.8 \text{ V}$, $V_{\text{OUT}} = 0 \text{ V}$, $V_{\text{CE}} = 0 \text{ V}$		0.2	1.0	μA
		RP402xxxxC/ D/ G/ H	$V_{\text{IN}} = 4.8 \text{ V}$, $V_{\text{CE}} = 0 \text{ V}$		1.2	2.5	
V_{OUT}	Output Voltage		$V_{\text{IN}} = V_{\text{CE}} = 1.5 \text{ V}$	x0.985		x1.015	V
$\Delta V_{\text{OUT}} / \Delta T_a$	Output-Voltage Temperature Coefficient		$-40^{\circ}\text{C} \leq T_a \leq 85^{\circ}\text{C}$		± 50		ppm / $^{\circ}\text{C}$
fosc	Switching Frequency	RP402xxx1x	$V_{\text{IN}} = 1.5 \text{ V}$, $V_{\text{OUT}} = 0.95 \times V_{\text{SET}}$	1080	1200	1320	kHz
		RP402xxx2x		900 850		1000	
R_{ONN}	NMOS ON Resistance ⁽¹⁾		$V_{\text{OUT}} = 5.0 \text{ V}$		0.20		Ω
R_{ONP}	PMOS ON Resistance ⁽¹⁾		$V_{\text{OUT}} = 5.0 \text{ V}$		0.20		Ω
I_{CEH}	CE "H" Input Current		$V_{\text{IN}} = 4.8 \text{ V}$, $V_{\text{OUT}} = V_{\text{CE}} = 5 \text{ V}$			0.5	μA
I_{CEL}	CE "L" Input Current		$V_{\text{IN}} = 4.8 \text{ V}$, $V_{\text{OUT}} = 5 \text{ V}$, $V_{\text{CE}} = 0 \text{ V}$	-0.5			μA
I_{MODEH}	MODE "H" Input Current ⁽³⁾	RP402xxx1x	$V_{\text{IN}} = 4.8 \text{ V}$, $V_{\text{CE}} = 0 \text{ V}$, $V_{\text{MODE}} = 5.5 \text{ V}$			0.5	μA
		RP402xxx2x				72	
I_{MODEL}	MODE "L" Input Current ⁽³⁾		$V_{\text{IN}} = 4.8 \text{ V}$, $V_{\text{CE}} = V_{\text{MODE}} = 0 \text{ V}$	-0.5			μA
I_{LXH}	Lx "H" Leakage Current		$V_{\text{IN}} = V_{\text{OUT}} = V_{\text{LX}} = 4.8 \text{ V}$, $V_{\text{CE}} = 0 \text{ V}$			0.5	μA
I_{LXL}	Lx "L" Leakage Current		$V_{\text{OUT}} = 5 \text{ V}$, $V_{\text{LX}} = 0 \text{ V}$, $V_{\text{CE}} = 0 \text{ V}$			0.5	μA
I_{LXPEAK}	Lx Limit Current ⁽⁴⁾			1.3	1.5		A

All test items listed under ELECTRICAL CHARACTERISTICS are done under the pulse load condition ($T_j \approx T_a = 25^{\circ}\text{C}$).

⁽¹⁾ Hold-on Voltage and NMOS/ PMOS ON Resistance are dependent on V_{OUT} .

⁽²⁾ Quiescent Current 2 is not applicable to RP402xxx2x.

⁽³⁾ MODE "H"/ "L" Input Current/ Voltage is only applicable to RP402Kxxxx.

⁽⁴⁾ Lx Limit Current fluctuates depending on Duty.

RP402x

No. EA-317-200604

ELECTRICAL CHARACTERISTICS (continued)

The specifications surrounded by are guaranteed by design engineering at $-40^{\circ}\text{C} \leq T_a \leq 85^{\circ}\text{C}$.

RP402xxxxx Electrical Characteristics (Not applicable to RP402K00xx)

($T_a = 25^{\circ}\text{C}$)

Symbol	Parameter	Condition	Min.	Typ.	Max.	Unit
V_{CEH}	CE "H" Input Voltage		0.7			V
V_{CEL}	CE "L" Input Voltage				0.3	V
V_{MODEH}	MODE "H" Input Voltage ⁽¹⁾		1.0			V
V_{MODEL}	MODE "L" Input Voltage ⁽¹⁾				0.4	V
Maxduty	Oscillator Maximum Duty Cycle	$V_{IN} = 1.5\text{ V}, V_{OUT} = 0.95 \times V_{SET}$	80	88	95	%
tstart	Soft-start Time ⁽²⁾	Measures the time when $V_{CE} = 0\text{ V}$ to 1.5 V , $V_{OUT} = V_{SET} \times 0.95$	0.25	0.5	0.70	ms
tprot	Protection Delay Time ⁽³⁾	RP402xxx1x	2.7	3.3	3.9	ms
		RP402xxx2x	3.5	4.1	4.7	
R_{ONA}	Anti-ringing Switch ON Resistance ⁽⁴⁾	$V_{IN} = 2.5\text{ V}, V_{OUT} = 3.3\text{ V}$		100		Ω
R_{ONB}	Bypass Switch ON Resistance ⁽⁵⁾	RP402xxxxC/ D/ G/ H $V_{IN} = 3.0\text{ V}, V_{OUT} = 0\text{ V}$		160		Ω
I_{INZERO}	V_{IN} Zero Current	$V_{IN} = 0\text{ V}, V_{OUT} = 5.5\text{ V}$		0.1	1.0	μA

All test items listed under ELECTRICAL CHARACTERISTICS are done under the pulse load condition ($T_j \approx T_a = 25^{\circ}\text{C}$).

⁽¹⁾ MODE "H"/ "L" Input Current/ Voltage is only applicable to RP402Kxxxx.

⁽²⁾ $V_{IN} \geq 1.7\text{ V}$

⁽³⁾ Protection Delay Time is not included in RP402xxxxB/ D/ F/ H.

⁽⁴⁾ Anti-ringing Switch ON Resistance is dependent on V_{OUT} . Not applicable to RP402xxx2x.

⁽⁵⁾ Bypass Switch ON Resistance is dependent on V_{IN} .

Electrical Characteristics by Different Output Voltage

Product Name	V _{OUT} (Ta = 25°C)		
	Min.	Typ.	Max.
RP402x18xx	1.773	1.800	1.827
RP402x19xx	1.872	1.900	1.929
RP402x20xx	1.970	2.000	2.030
RP402x21xx	2.069	2.100	2.132
RP402x22xx	2.167	2.200	2.233
RP402x23xx	2.266	2.300	2.335
RP402x24xx	2.364	2.400	2.436
RP402x25xx	2.463	2.500	2.538
RP402x26xx	2.561	2.600	2.639
RP402x27xx	2.660	2.700	2.741
RP402x28xx	2.758	2.800	2.842
RP402x29xx	2.857	2.900	2.944
RP402x30xx	2.955	3.000	3.045
RP402x31xx	3.054	3.100	3.147
RP402x32xx	3.152	3.200	3.248
RP402x33xx	3.251	3.300	3.350
RP402x34xx	3.349	3.400	3.451
RP402x35xx	3.448	3.500	3.553
RP402x36xx	3.546	3.600	3.654
RP402x37xx	3.645	3.700	3.756
RP402x38xx	3.743	3.800	3.857
RP402x39xx	3.842	3.900	3.959
RP402x40xx	3.940	4.000	4.060
RP402x41xx	4.039	4.100	4.162
RP402x42xx	4.137	4.200	4.263
RP402x43xx	4.236	4.300	4.365
RP402x44xx	4.334	4.400	4.466
RP402x45xx	4.433	4.500	4.568
RP402x46xx	4.531	4.600	4.669
RP402x47xx	4.630	4.700	4.771
RP402x48xx	4.728	4.800	4.872
RP402x49xx	4.827	4.900	4.974
RP402x50xx	4.925	5.000	5.075
RP402x51xx	5.024	5.100	5.177
RP402x52xx	5.122	5.200	5.278
RP402x53xx	5.221	5.300	5.380
RP402x54xx	5.319	5.400	5.481
RP402x55xx	5.417	5.500	5.582

RP402x

No. EA-317-200604

ELECTRICAL CHARACTERISTICS (continued)

The specifications surrounded by are guaranteed by design engineering at $-40^{\circ}\text{C} \leq T_a \leq 85^{\circ}\text{C}$.

RP402K00xx Electrical Characteristics

($T_a = 25^{\circ}\text{C}$)

Symbol	Parameter	Condition	Min.	Typ.	Max.	Unit	
V_{IN}	Input Voltage				4.6	V	
V_{START}	Start-up Voltage	$R_L = 5.5 \text{ k}\Omega$		0.7	0.8	V	
V_{HOLD}	Hold-on Voltage after start-up ⁽¹⁾	$R_L = 5.5 \text{ k}\Omega$	0.6			V	
V_{OVLO}	OVLO Voltage		4.6	5.1		V	
V_{OVP}	OVP Voltage			6.0		V	
I_{DD1}	Quiescent Current 1	$V_{IN} = 3 \text{ V}, V_{OUT} = 5 \text{ V}, V_{FB} = 0.6 \text{ V}$		1.6		mA	
I_{DD2}	Quiescent Current 2 ⁽²⁾	$V_{IN} = 4.8 \text{ V}, V_{OUT} = 5.5 \text{ V}, V_{FB} = 2.0 \text{ V}, V_{MODE} = 0 \text{ V}$		21	37	μA	
Istandby	Standby Current	RP402KxxxA/ B	$V_{IN} = 4.8 \text{ V}, V_{OUT} = 0 \text{ V}, V_{CE} = 0 \text{ V}$		0.2	1.0	μA
		RP402KxxxC/ D	$V_{IN} = 4.8 \text{ V}, V_{CE} = 0 \text{ V}$		1.2	2.5	
V_{FB}	Feedback Voltage	$V_{IN} = 3.0 \text{ V}, V_{OUT} = 5 \text{ V}$	0.985	1.00	1.015	V	
$\frac{\Delta V_{FB}}{\Delta T_a}$	Output Voltage Temperature Coefficient	$-40^{\circ}\text{C} \leq T_a \leq 85^{\circ}\text{C}$		± 50		ppm/ $^{\circ}\text{C}$	
fosc	Switching Frequency	RP402K001x	$V_{IN} = 3.0 \text{ V}, V_{OUT} = 3.3 \text{ V}, V_{FB} = 0.6 \text{ V}$	1080	1200	1320	kHz
		1020		1380			
		RP402K002x		900	1000	1100	
				850		1150	
R_{ONN}	NMOS ON Resistance ⁽¹⁾	$V_{OUT} = 5.0 \text{ V}$		0.20		Ω	
R_{ONP}	PMOS ON Resistance ⁽¹⁾	$V_{OUT} = 5.0 \text{ V}$		0.20		Ω	
I_{CEH}	CE "H" Input Current	$V_{IN} = 4.8 \text{ V}, V_{OUT} = V_{CE} = 5.5 \text{ V}$			0.5	μA	
I_{CEL}	CE "L" Input Current	$V_{IN} = 4.8 \text{ V}, V_{OUT} = 5 \text{ V}, V_{CE} = 0 \text{ V}$	-0.5			μA	
I_{MODEH}	MODE "H" Input Current	RP402K001x	$V_{IN} = 4.8 \text{ V}, V_{MODE} = 5.5 \text{ V}, V_{CE} = 0 \text{ V}$			0.5	μA
		RP402K002x				72	
I_{MODEL}	MODE "H" Input Current	$V_{IN} = 4.8 \text{ V}, V_{CE} = V_{MODE} = 0 \text{ V}$	-0.5			μA	
I_{LXH}	Lx "H" Leakage Current	$V_{IN} = V_{OUT} = V_{LX} = 4.8 \text{ V}, V_{CE} = 0 \text{ V}$			0.5	μA	
I_{LXL}	Lx "L" Leakage Current	$V_{OUT} = 5.0 \text{ V}, V_{LX} = 0 \text{ V}, V_{CE} = 0 \text{ V}$			0.5	μA	
I_{LXPEAK}	Lx Limit Current ⁽³⁾		1.3	1.5		A	

All test items listed under ELECTRICAL CHARACTERISTICS are done under the pulse load condition ($T_j \approx T_a = 25^{\circ}\text{C}$).

⁽¹⁾ Hold-on Voltage and NMOS/ PMOS ON Resistance are dependent on V_{OUT} .

⁽²⁾ Quiescent Current 2 is not applicable to RP402K002x.

⁽³⁾ Lx Limit Current fluctuates depending on Duty.

ELECTRICAL CHARACTERISTICS (continued)

The specifications surrounded by are guaranteed by design engineering $-40^{\circ}\text{C} \leq T_a \leq 85^{\circ}\text{C}$.

RP402K00xx Electrical Characteristics

($T_a = 25^{\circ}\text{C}$)

Symbol	Parameter	Condition	Min.	Typ.	Max.	Unit
V_{CEH}	CE "H" Input Voltage		0.7			V
V_{CEL}	CE "L" Input Voltage				0.3	V
V_{MODEH}	MODE "H" Input Voltage		1.0			V
V_{MODEL}	MODE "L" Input Voltage				0.4	V
Maxduty	Oscillator Maximum Duty Cycle	$V_{IN} = 3.0\text{ V}$, $V_{OUT} = 3.3\text{ V}$, $V_{FB} = 0.6\text{ V}$	80	88	95	%
tstart	Soft-start Time ⁽¹⁾	Measures the time when $V_{OUT} = 3.3\text{ V}$, $V_{CE} = 0\text{ V}$ to 1.5 V , $V_{OUT} = 3.13\text{ V}$	0.25	0.5	0.70	ms
tprot	Protection Delay Time ⁽²⁾	RP402K001x	-	3.3	3.9	ms
		RP402K002x	-	4.1	4.7	ms
R_{ONA}	Anti-ringing Switch ON Resistance ⁽³⁾	$V_{IN} = 2.5\text{ V}$, $V_{OUT} = 3.3\text{ V}$		100		Ω
R_{ONB}	Bypass Switch ON Resistance ⁽⁴⁾	RP402KxxxC/ D $V_{IN} = 3.0\text{ V}$, $V_{OUT} = 0\text{ V}$		160		Ω
I_{INZERO}	V_{IN} Zero Current	$V_{IN} = 0\text{ V}$, $V_{OUT} = 5.5\text{ V}$		0.1	1.0	μA

All test items listed under ELECTRICAL CHARACTERISTICS are done under the pulse load condition ($T_j \approx T_a = 25^{\circ}\text{C}$).

⁽¹⁾ Soft-start Time is $V_{IN} \geq 1.7\text{ V}$.

⁽²⁾ Quiescent Current 2 is not applicable to RP402K002x.

⁽³⁾ L_x Limit Current fluctuates depending on Duty.

⁽⁴⁾ Bypass Switch ON Resistance is dependent on V_{IN} .

THEORY OF OPERATION

Forced PWM Control Type (RP402xx2A/ B)

While normal PWM control type prevents the reverse inductor current at light load, forced PWM control type makes the inductor current reverse in order to eliminate the discontinuous current period. Therefore, even at light load or when the voltage difference between input and output is less, forced PWM control type can provide PWM operation without bursting.

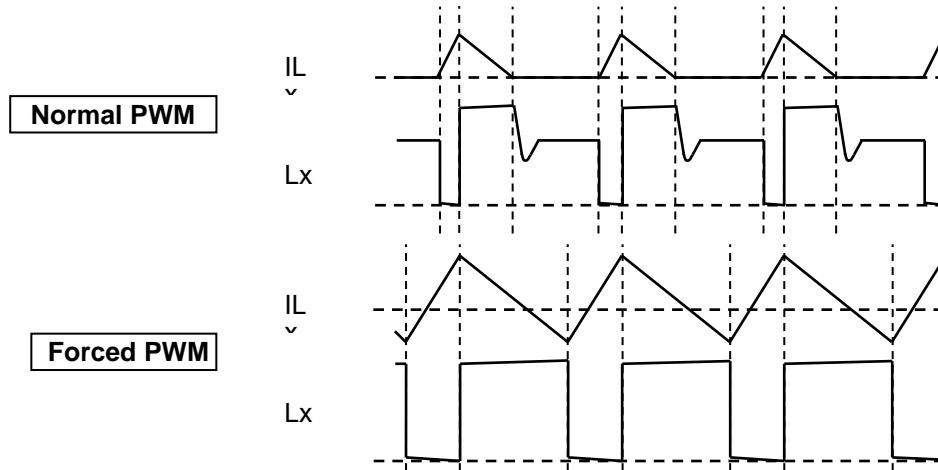

Operating Waveform of Normal PWM/ Forced PWM Control Type

There is a case that forced PWM control performs burst operation without PWM operation because of the conditions of use. The conditions which cause burst operation are various and differ in set output voltage, input voltage, ambient temperature and load current.

Please note that forced PWM control type decreases the efficiency at light load and does not include anti-ringing switch. The graph below indicates the typical operational maximum input voltage of forced PWM control type.

RP402Kxx1x: MODE = "H" (Normal PWM), RP402Kxx2x: (Forced PWM)

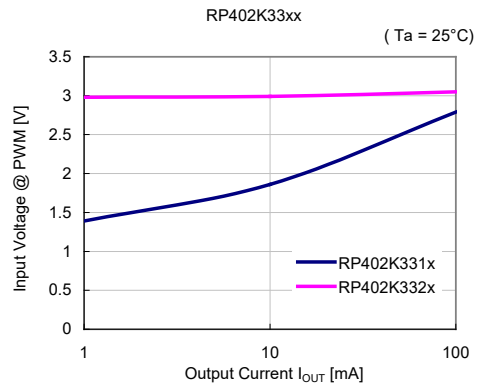
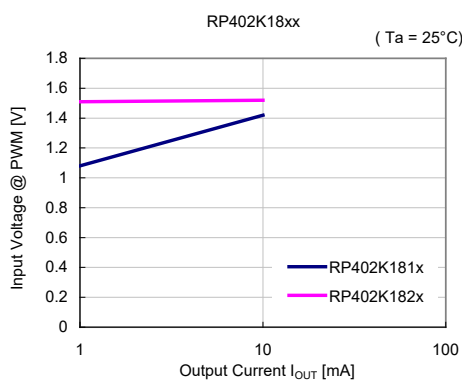

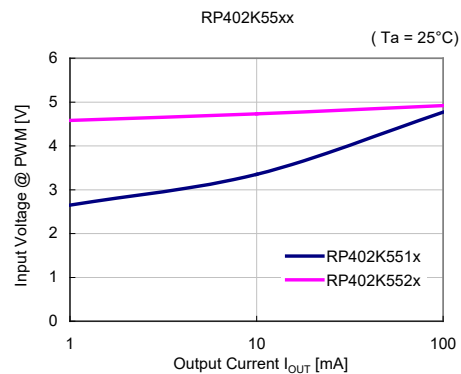
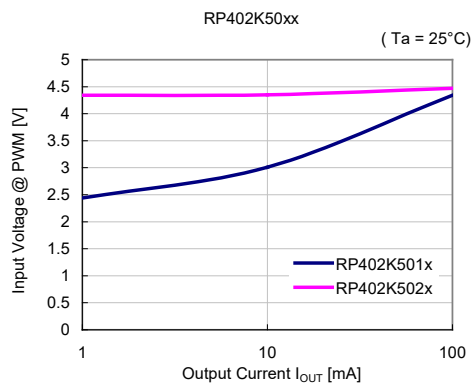

MODE Pin (applied to the RP402K only)

When setting the MODE pin "H" of RP402K, it is recommended to connect the MODE pin "H" to the V_{OUT} pin with considering its threshold level.

As the MODE "H" input voltage of the MODE pin is 1V or higher, the voltage may become lower than 1V when pulling up to V_{IN}.

Since the RP402Kxx2A and xx2B have only Forced PWM control type, therefore, set MODE pin as "H". Note that a current flows through the built-in pull-down resistor of MODE pin and consumes power even in a standby state (CE="L") if the MODE pin is connected to V_{IN} pin. For this reason, MODE pin should be connected to V_{OUT} side.

Bypass Mode Application Example (RP402xxxxC/ D/ G/ H)

The RP402xxxxC/ D/ G/ H is available in bypass mode when CE = L. The shown below is the application example of the device in bypass mode. In this application, when the main system is not in sleep, the RP402xxxxC/ D/ G/ H is set to active state to supply power to the main system and RTC. When the main system is in sleep, the RP 402xxxxC/ D/ G/ H is set to standby state to supply power to RTC in bypass mode. Using the device in the bypass mode can reduce the power loss and the consumption of battery. Also, using the device in bypass mode can eliminate external components for short-circuit protection.

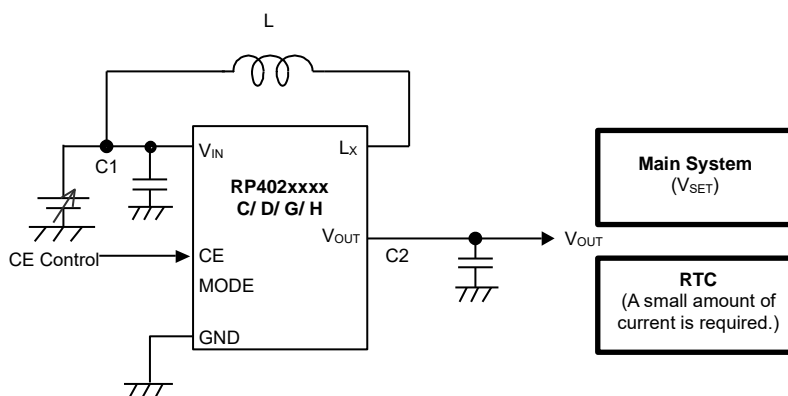

RP402x

No. EA-317-200604

Regulation Operation at $V_{IN} > V_{OUT}$

The RP402x regulates the output voltage to the set output voltage even when the input voltage is higher than the set output voltage. Please note that this regulation operation decreases the efficiency and the maximum output current driving ability. The maximum output current driving ability can be different due to the set output voltage, the input voltage and the ambient temperature.

The following is the switching condition (Typ.) from step-up operation to the step-down regulation.

$V_{IN} \leq V_{OUT} - 150$ mV: Step-down regulation → Step-up operation

$V_{IN} > V_{OUT} - 100$ mV: Step-up operation → Step-down regulation

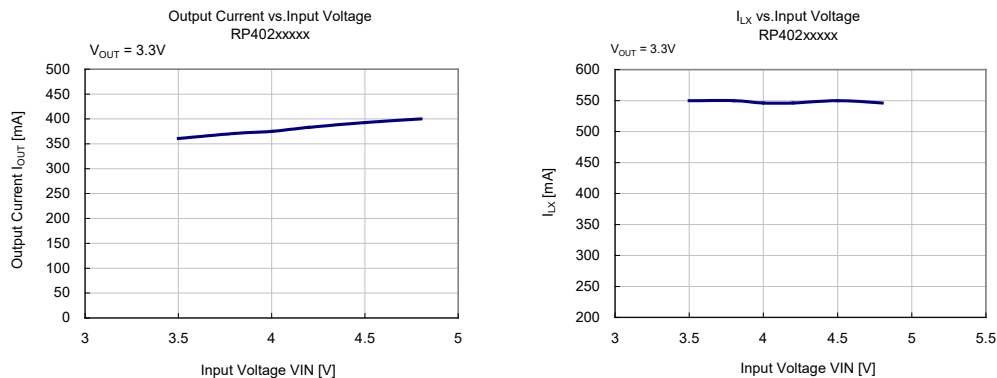

Output Voltage Setting for RP402K00xx

The RP402K00xx can set the output voltage freely by the external divider resistors using the following equation.

$$\text{Output Voltage} = V_{FB} \times (R1 + R2) / R2 \quad (V_{FB} = 1.0 \text{ V})$$

Zero Input Complete Shutdown at $V_{IN} = 0$ V

The RP402x provides a zero input complete shutdown function that allows the device to shut down the output when $V_{IN} = 0$ V or $V_{IN} = \text{open}$. This function protects against reverse current flow from V_{OUT} to V_{IN} when a voltage is applied to the V_{OUT} pin while $V_{IN} = 0$ V or $V_{IN} = \text{open}$.

Overcurrent Protection

The RP402x incorporates a I_{LX} peak current limit circuit as the overcurrent protection circuit which controls the duty of I_{LX} when the I_{LX} peak current (I_{LXPEAK}) reaches typically 1.5 A.

Latch Type Protection (RP402xxxxA/ C/ E/ G)

The RP402xxxxA/ C/ E/ G provides a latch type protection circuit to latch the power MOSFET to the off state in order to stop the DC/DC operation. To release the latch type protection, switch the CE pin from high to low once and switch it back to high while the power is turned on. Please note that the I_{LX} peak current (I_{LXPEAK}) and the protection delay time (t_{prot}) are easily affected by the self-heating or heat radiation efficiency. The large reduction in input voltage (V_{IN}) or the unstable input voltage caused by short-circuit may affect the protection operation or protection delay time.

Short-circuit Protection

The RP402x provides a short-circuit protection which stops the switching operation when a short circuit is detected. After a consecutive fixed period of the short-circuit state, the device performs a restart with soft-start operation. RP402xxxxA/ C/ E/ G latches the power in a stop state when the input voltage becomes lower than typically 1.6V and it is short-circuited.

Overvoltage Protection

The RP402x provides an overvoltage lockout (OVLO) circuit for monitoring the input pin voltage and an overvoltage protection (OVP) circuit for monitoring the output pin voltage. These circuits stop the switching operation when an overvoltage is detected. If the output voltage is dropped below the set output voltage when OVLO is released, the output voltage will be boosted to the set output voltage.

OUTPUT CURRENT AND SELECTION OF EXTERNAL COMPONENTS

Operation of Step-up DC/DC Converter and Output Current

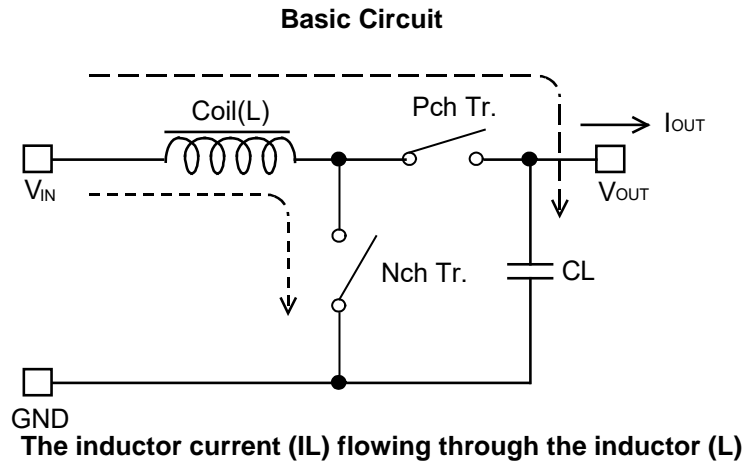

Discontinuous Mode

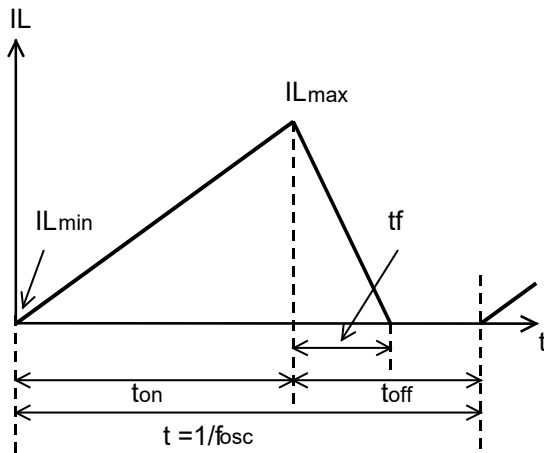

Continuous Mode

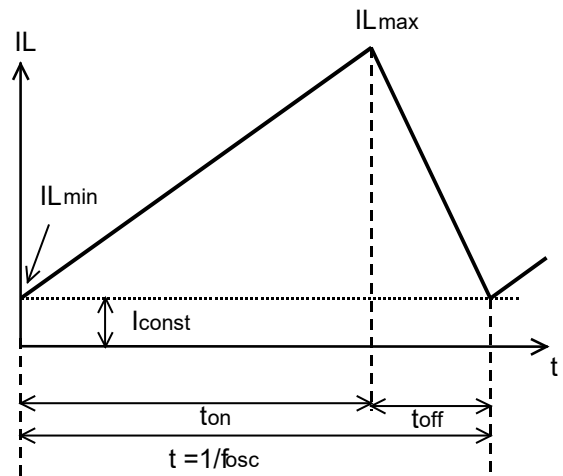

A PWM control type step-up DC/DC converter has two operation modes characterized by the continuity of inductor current: discontinuous current mode and continuous current mode.

The voltage applied to the inductor L, when transistor is ON, is described as “V_{IN}”. So, the current is described as “V_{IN} x t / L”.

Therefore, the electric power (P_{ON}) supplied from the input side, while transistor is ON, is described as follows:

$$P_{ON} = \int_0^{ton} V_{IN}^2 \times t/L dt \dots\dots\dots \text{Equation 1}$$

In step-up circuit, power source supplies the electric power (P_{OFF}) even while transistor is OFF. The input current supplied by power source while transistor is OFF is described as “ $(V_{OUT} - V_{IN}) \times t / L$ ”. Therefore, the electric power P_{OFF} is described as follows:

$$P_{OFF} = \int_0^{t_f} V_{IN} \times (V_{OUT} - V_{IN}) \times t/L \, dt \dots\dots\dots \text{Equation 2}$$

The time of which the inductance L releases the saved energy is described as “ t_f ”. Therefore, the average electric power (P_{AV}) in a cycle is described as follows:

$$P_{AV} = 1/(t_{on} + t_{off}) \times \left\{ \int_0^{t_{on}} V_{IN}^2 \times t/L \, dt + \int_0^{t_f} V_{IN} \times (V_{OUT} - V_{IN}) \times t/L \, dt \right\} \dots\dots\dots \text{Equation 3}$$

In PWM control, when “ $t_f = t_{off}$ ”, the inductor current becomes continuous, so the switching regulator operation turns into continuous current mode. The current deviation between On time and Off time is equal under steady-state condition of continuous current mode as follows:

$$V_{IN} \times t_{on} / L = (V_{OUT} - V_{IN}) \times t_{off} / L \dots\dots\dots \text{Equation 4}$$

The electric power (P_{AV}) is equal to the output voltage ($V_{OUT} \times I_{OUT}$). Therefore, I_{OUT} is as follows:

$$I_{OUT} = f_{osc} \times V_{IN}^2 \times t_{on}^2 / \{2 \times L \times (V_{OUT} - V_{IN})\} = V_{IN}^2 \times t_{on} / (2 \times L \times V_{OUT}) \dots\dots\dots \text{Equation 5}$$

When I_{OUT} becomes more than $V_{IN} \times t_{on} \times t_{off} / (2 \times L \times (t_{on} + t_{off}))$, the inductor current becomes continuous, so the switching regulator operation turns into continuous current mode. The continuous inductor current is described as I_{CONST} , so I_{OUT} is described as follows:

$$I_{OUT} = f_{osc} \times V_{IN}^2 \times t_{on}^2 / (2 \times L \times (V_{OUT} - V_{IN})) + V_{IN} \times I_{CONST} / V_{OUT} \dots\dots\dots \text{Equation 6}$$

The peak current (I_{Lmax}) flowing through the inductor is described as follows:

$$I_{Lmax} = I_{CONST} + V_{IN} \times t_{on} / L \dots\dots\dots \text{Equation 7}$$

Put Equation 4 into Equation 6 to solve I_{Lmax} . I_{Lmax} is described as follows:

$$I_{Lmax} = V_{OUT} / V_{IN} \times I_{OUT} + V_{IN} \times t_{on} / (2 \times L) \dots\dots\dots \text{Equation 8}$$

However, $t_{on} = (1 - V_{IN} / V_{OUT}) / f_{osc}$. The peak current is more than I_{OUT} .

Please consider I_{Lmax} when setting conditions of input and output, as well as selecting the external components. The peak current in the discontinuous current mode in Equation 7 can be calculated by $I_{CONST} = 0$.

Please note: The above calculation formulas are based on the ideal operation of the device in continuous mode. The loss caused by the external components and the built-in Lx switch are not included. Please use the peak current in Equation 8 as a reference when selecting an inductor.

TIMING CHART

Soft-start Operation and Latch-type Protection Operation

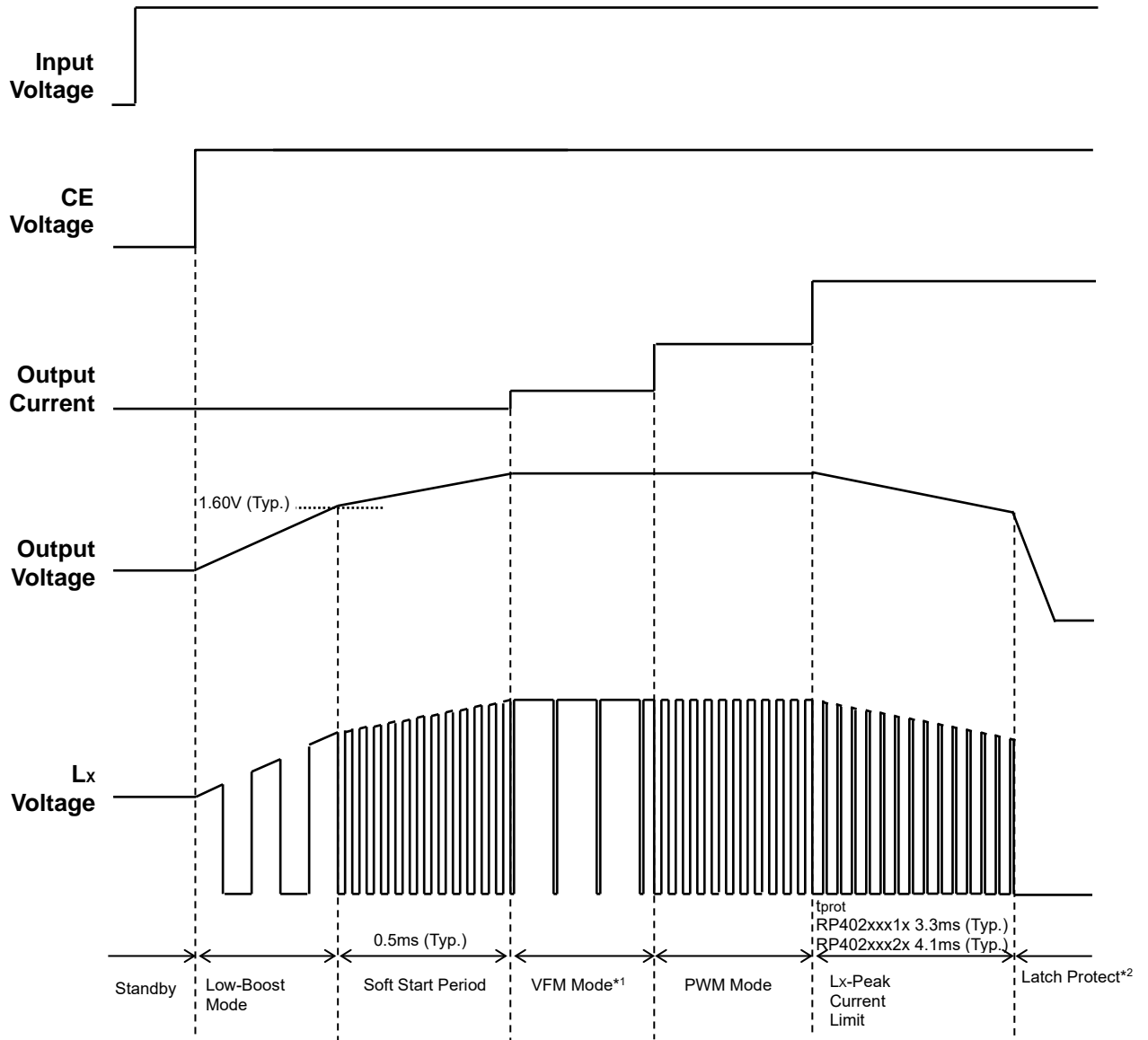

*1 Only for RP402xxx1x (MODE = "L")

*2 Only for RP402xxxA/ C/ E/ G

< Start-up >

When CE is changed from "L" to "H", DC/DC converter starts up the operation. The RP402x has Low-Boost mode which can start up with low voltage such as 0.7 V. The DC/DC boosts up with Low-Boost mode until the output voltage reaches to typically 1.6 V. When the output voltage becomes more than or equal to typically 1.6 V, the soft-start operation starts in order to control inrush current. The DC/DC boosts up the output voltage until it reaches to the setting output voltage.

Please note: During Low-Boost mode, the oscillator frequency is dropped, so the step-up ability is low compared to the normal operation mode. Please pay attention to the step-up ratio and the load current. Soft-start time depends on “set output voltage”, “input voltage”, “ambient temperature”, and “load current”.

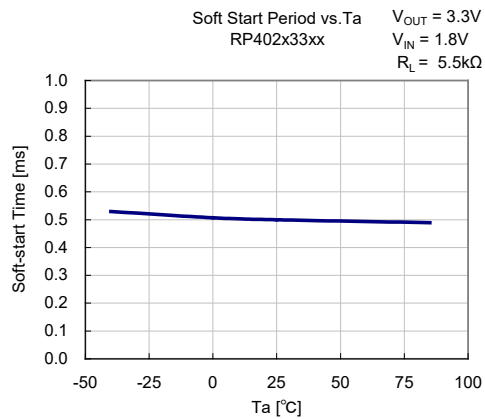
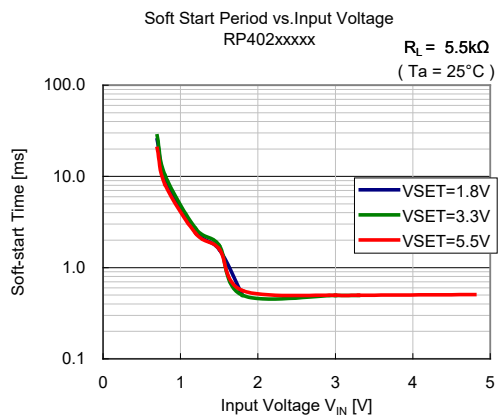

APPLICATION INFORMATION

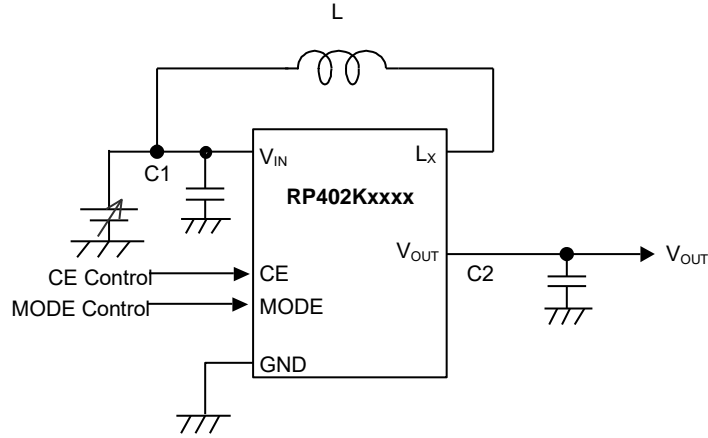

RP402Kxxxx Typical Application (Fixed Output Voltage Type)

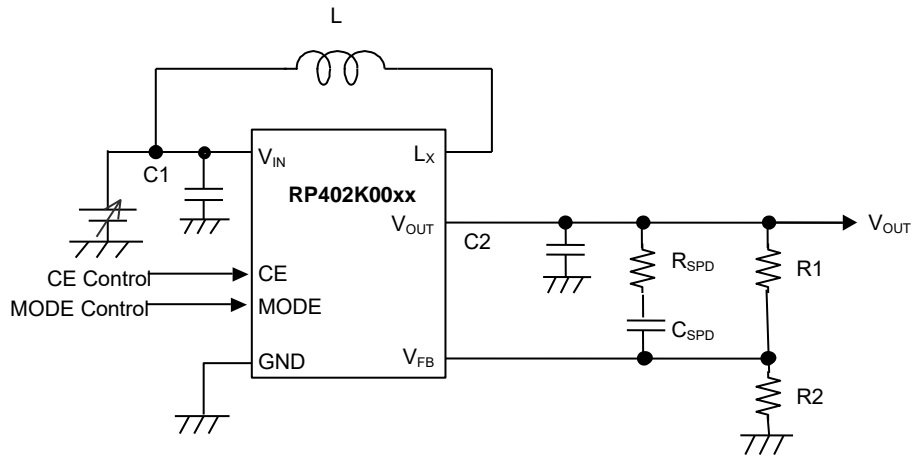

RP402K00xx Typical Application (Adjustable Output Voltage Type)

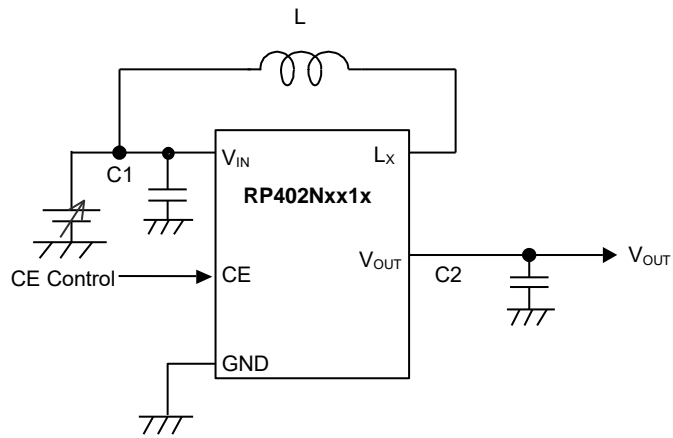

RP402Nxx1x Typical Application (Fixed Output Voltage Typ)

Recommended Components

Symbol	Descriptions
L	VLF403215MT-2R2M, 2.2 μ H, TDK VLS3012HBX-2R2M, TDK NRS5020T2R2NMGJ, TAIYO YUDEN
C1 (C _{IN})	GRM188R60J106ME47, 10 μ F, Murata
C2 (C _{OUT})	GRM188R60J106ME47, 10 μ F x 2, Murata As for the fixed output voltage type (RP402x50xx), 10 μ F x 1 can be used if the mounting area is limited.
C _{SPD}	The speedup capacitor (C _{SPD}) is required for the adjustable output voltage type. Connect C _{SPD} in parallel with the output resistor (R1). To calculate the C _{SPD} value, the following equation can be used: $f = 1 / (2 \pi \times C_{SPD} \times R1)$ Adjust the C _{SPD} value to make the oscillator frequency (f) approximately 20 kHz. For example, V _{OUT} = 5.0 V, R1 = 2 M Ω , R2 = 500 k Ω and C _{SPD} = 4 pF. The R1 and R2 values are calculated based on the operation efficiency under a light load, therefore R1 and R2 are having high-resistance values. The feedback voltage (V _{FB}) can be affected by noise. To stabilize the device operation, decrease the R1 and R2 values.
R _{SPD}	The speedup resistor (R _{SPD}) is required for the adjustable output voltage type. Using R _{SPD} can prevent the deterioration of the characteristics due to noise. If there's a possibility of generation of a spike noise, use an approximately 1 k Ω R _{SPD} .

TECHNICAL NOTES

The performance of a power source circuit using this device is highly dependent on a peripheral circuit. A peripheral component or the device mounted on PCB should not exceed its rated voltage, rated current or rated power. When designing a peripheral circuit, please be fully aware of the following points. (Refer to *PCB Layout Considerations* below.)

- Ensure the V_{IN} and GND lines are firmly connected. A large switching current flows through the GND lines and the V_{IN} line. If their impedance is too high, noise pickup or unstable operation may result. When the built-in switch is turned off, the inductor may generate a spike-shaped high voltage. Use the high-breakdown voltage capacitor (C_{OUT}) which output voltage is 1.5 times or more than the set output voltage.
- After a boosting of the step-up converter, the converter uses V_{OUT} as a main power source. Therefore, the ceramic capacitor between the V_{OUT} pin and the GND pin acts as a bypass capacitor. Considering the bias dependence, place a 10 μ F or more ceramic capacitor (C_{OUT}) between the V_{OUT} pin - the GND pin as close as possible. Also, place an approximately 10 μ F ceramic capacitor (C_{IN}) between the V_{IN} pin - the GND pin.
- Use a 2.2 μ H inductor (L) which is having a low equivalent series resistance, having enough tolerable current and which is less likely to cause magnetic saturation.
- The MODE pin is controlled with a logic voltage. To make it "H", 1.0 V or more must be forced to the MODE pin. If power supply is less than 1.0 V, MODE pin must be pulled up to V_{OUT} .
- When using Forced PWM Control Type, the MODE pin should be "H".
- The RP402x can reset the latch protection circuit by setting the CE signal 'L' ($V_{CE} < 0.3$ V) once while the power is switched on ($V_{IN} > 0.8$ V). If setting the CE pin when V_{IN} does not reach 0.8 V due to too large C_{IN} , the latch protection circuit cannot be reset correctly. Likewise, if starting the device up when the CE pin is shorted to the V_{IN} pin or V_{OUT} pin, the latch protection circuit cannot be reset.
- If controlling the CE pin by input voltage, the gradient of the power supply at rising must be considered. So, the CE pin must be connected via the delay circuit or the voltage detector to become the CE pin voltage less than 0.3 V until the V_{IN} becomes more than 0.8V.

PCB Layout Considerations

Current Path on PCB

Figure 1 and Figure 2 show the current pathways of application circuits when MOSFET is turned ON or when MOSFET is turned OFF, respectively. As shown in Figure 1 and Figure 2, the currents flow in the directions of blue or green arrows. The parasitic components (impedance, inductance or capacitance) formed in the pathways indicated by the red arrows affect the stability of the system and become the cause of noise. Reduce the parasitic components as much as possible. The current pathways should be made by short and thick wirings.

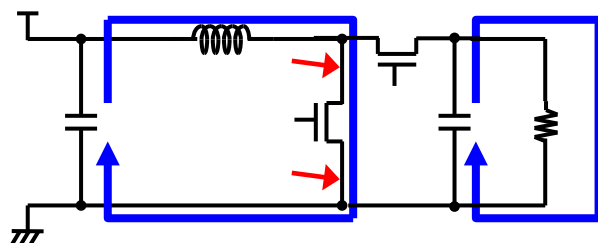

Figure 1. MOSFET-ON

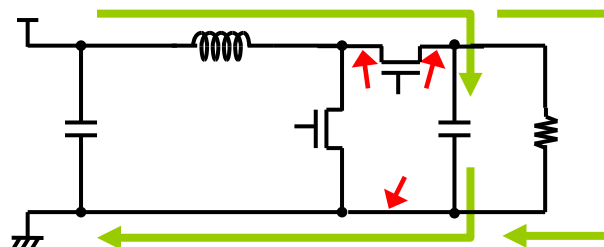
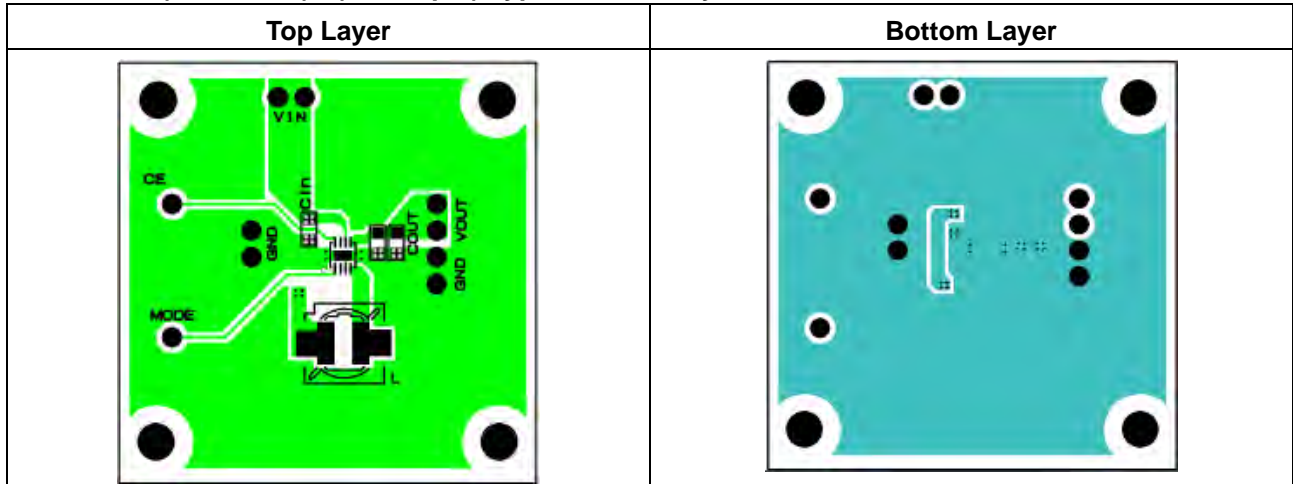

Figure 2. MOSFET-OFF

RP402x

No. EA-317-200604

RP402Kxxxx (PKG: DFN(PL)2020-8pin) Typical Board Layout



RP402K00xx (PKG: DFN(PL)2020-8pin) Typical Board Layout

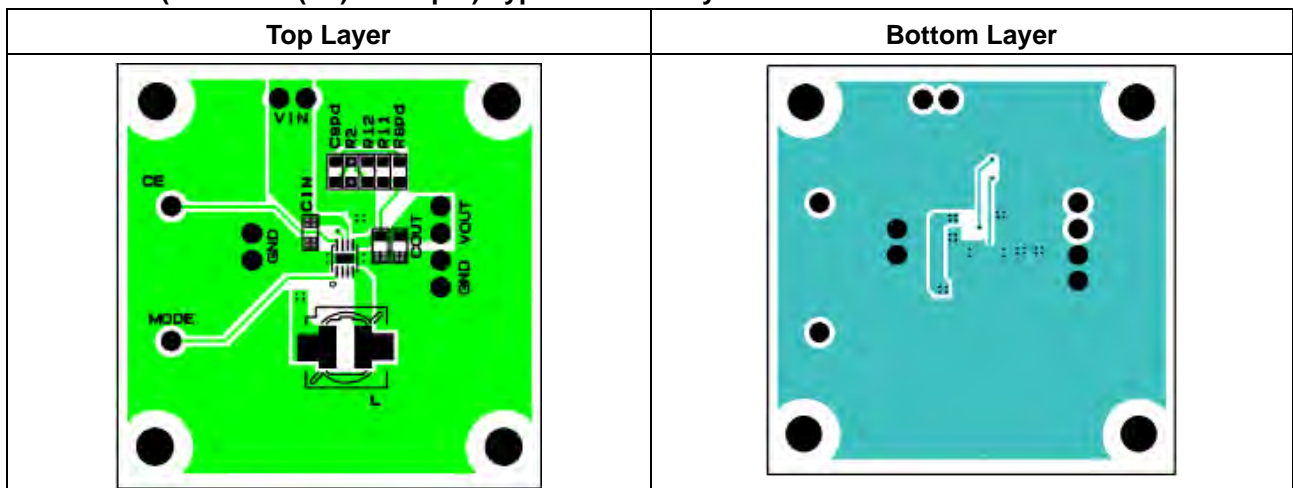

RP402Nxxxx (PKG: SOT-23-5pin) Typical Board Layout

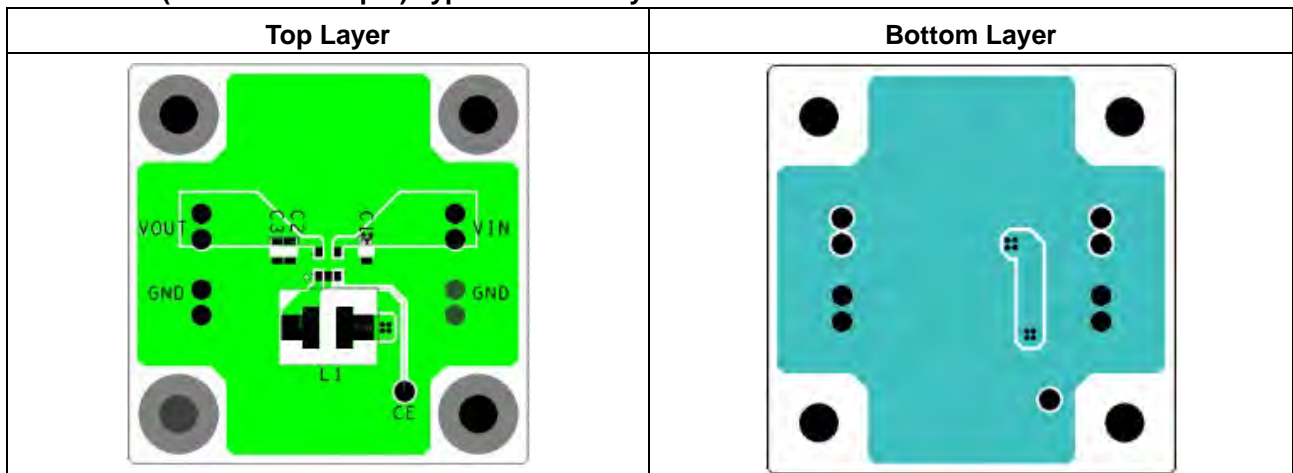

TYPICAL CHARACTERISTICS

Note: Typical Characteristics are intended to be used as reference data; they are not guaranteed.

1) Output Voltage vs. Output Current

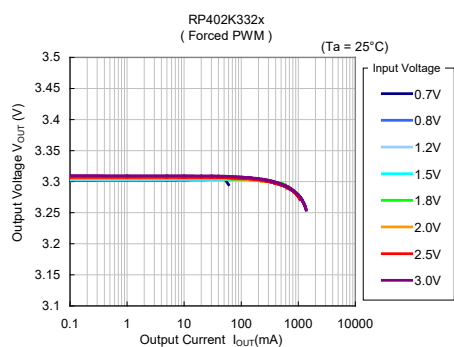
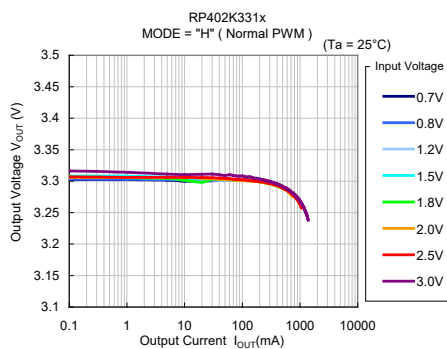
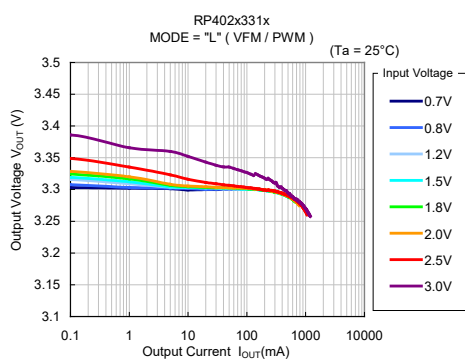
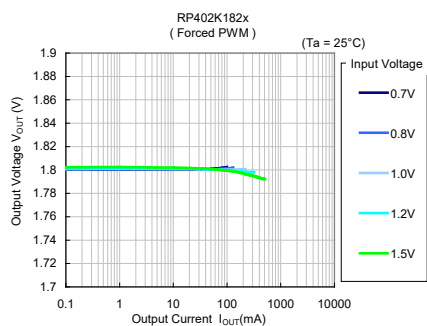
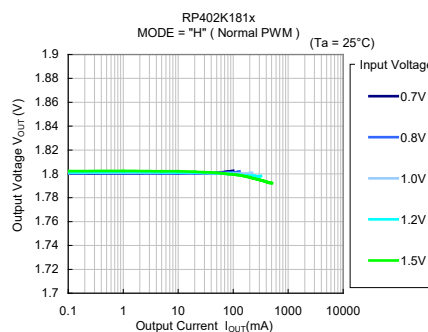
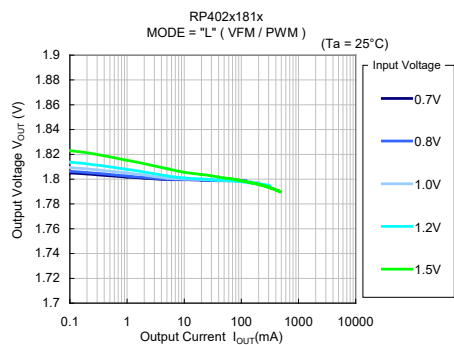

RP402x

No. EA-317-200604

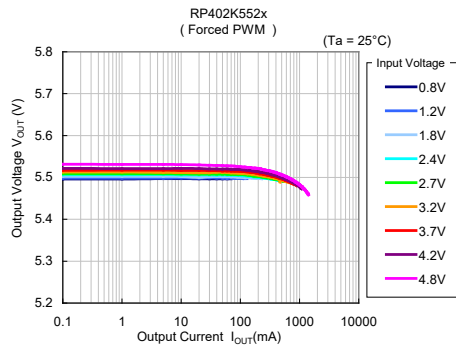
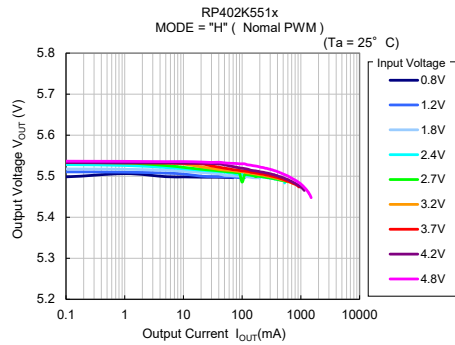
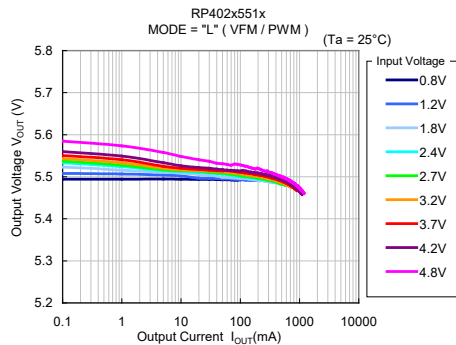
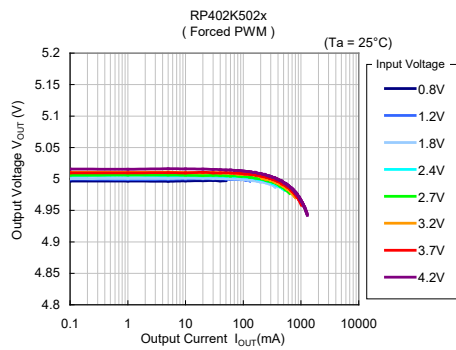
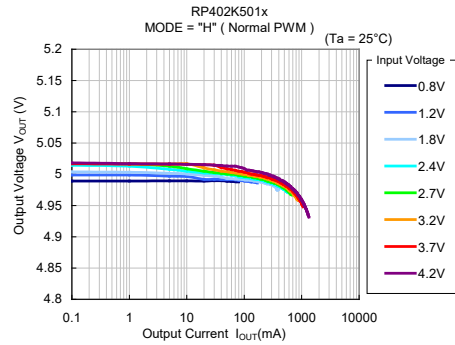
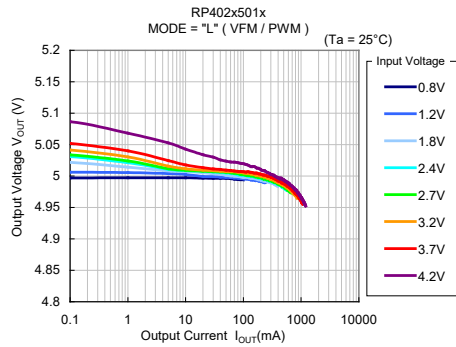

2) Efficiency vs. Output Current

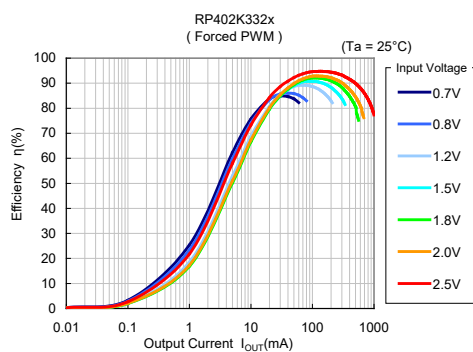
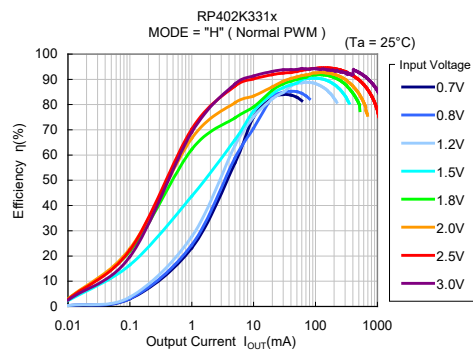
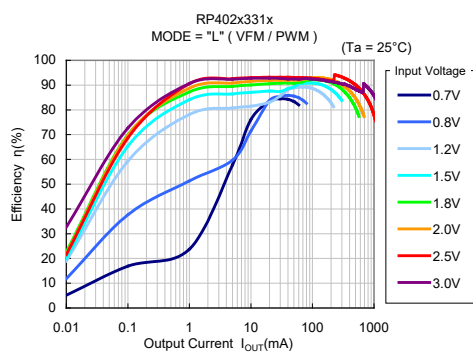
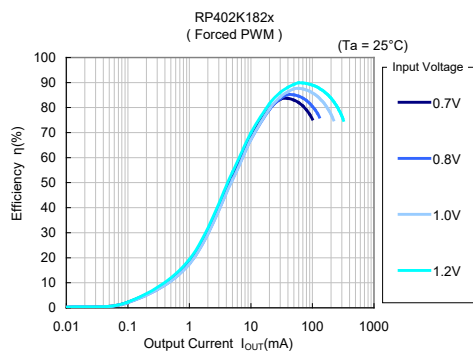
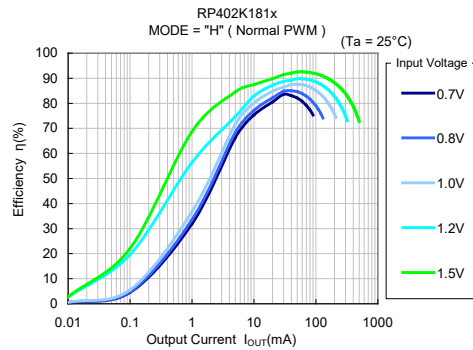
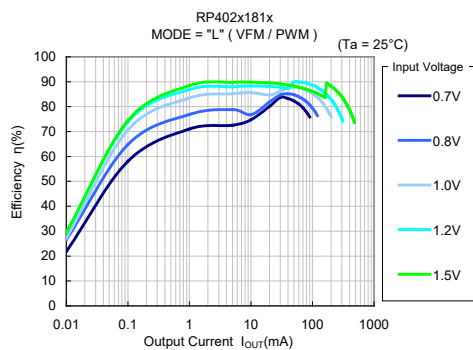

RP402x

No. EA-317-200604

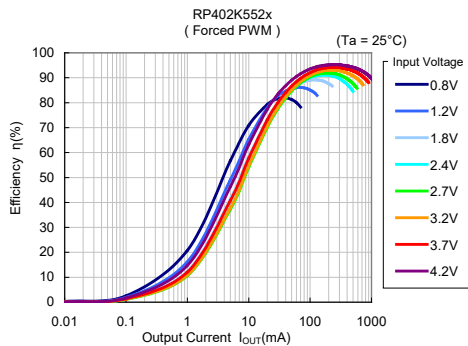
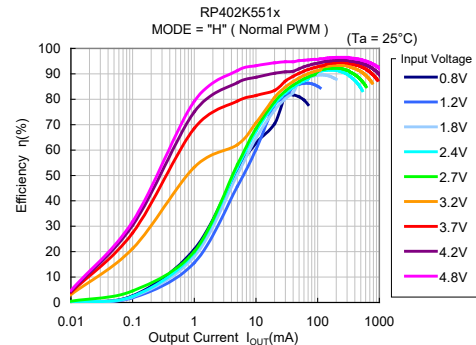
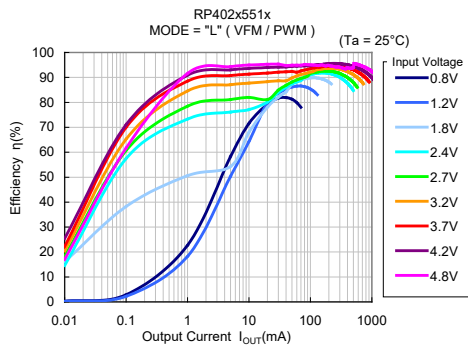
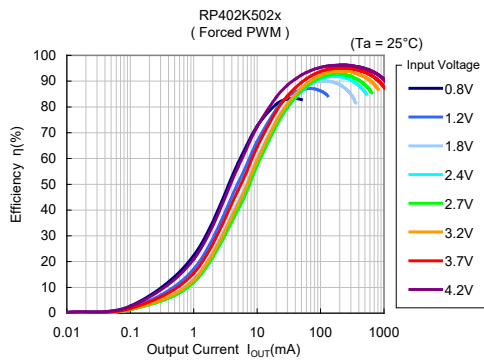
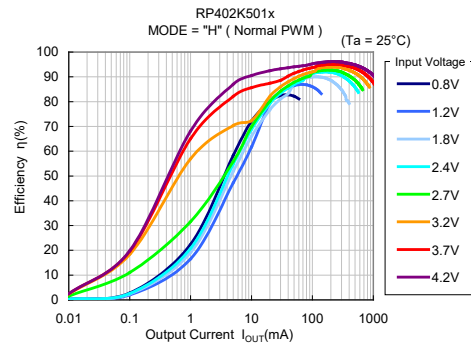
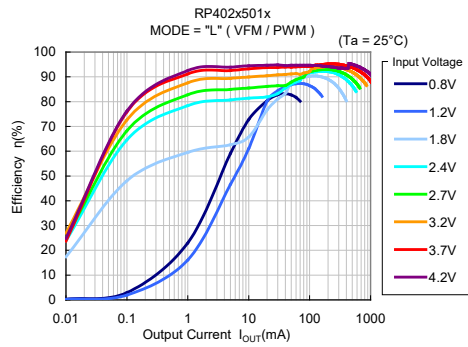

3) Standby Current vs. Ambient Temperature

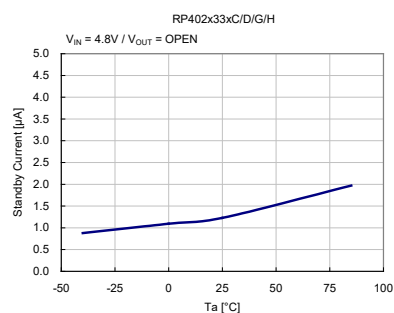
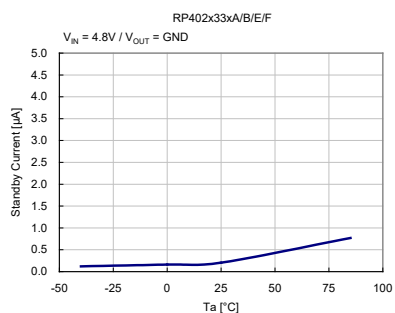

4) Supply Current 1 vs. Ambient Temperature

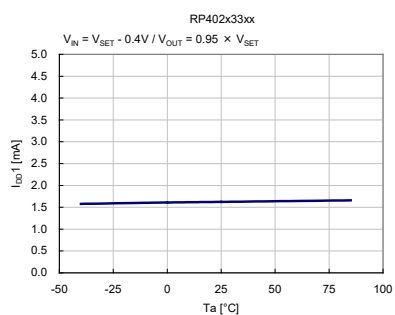

5) Supply Current 2 vs. Ambient Temperature

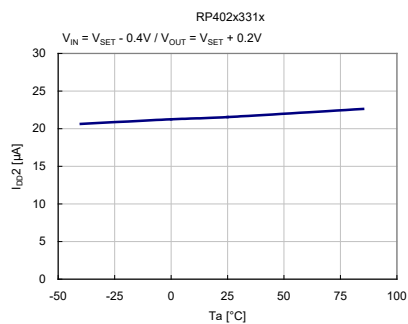

6) Start-up vs. Ambient Temperature

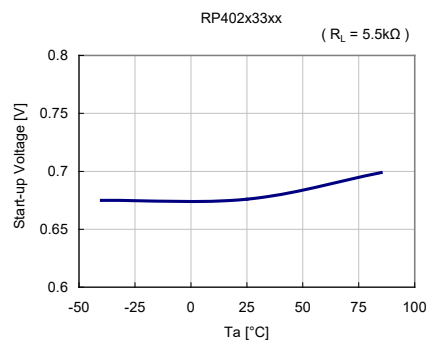

RP402x

No. EA-317-200604

7) Hold-on Voltage vs. Ambient Temperature

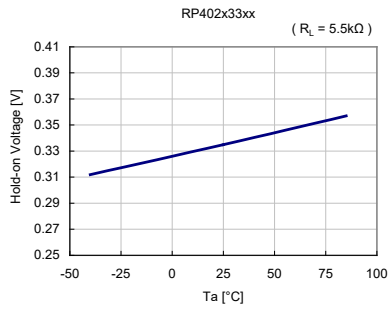

8) Oscillator Frequency vs. Ambient Temperature

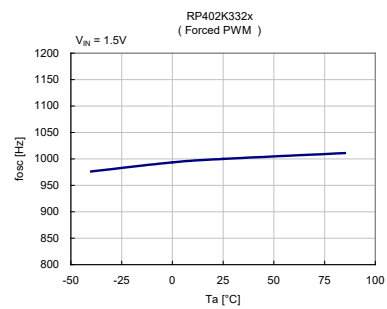
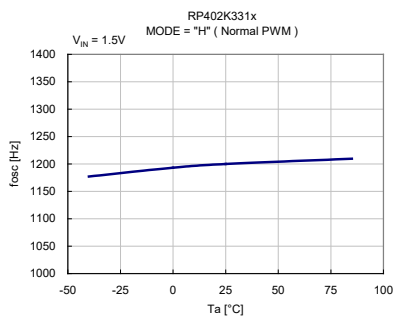

9) Maxduty vs. Ambient Temperature

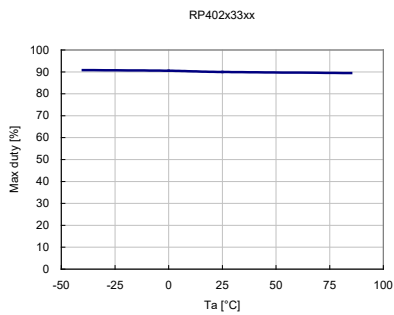

10) Lx Current Limit vs. Duty

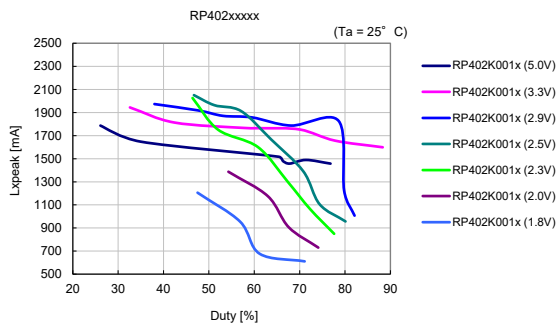

11) Lx Current Limit vs. Ambient Temperature

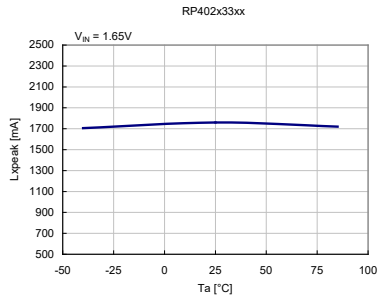

12) CE "H" Input Voltage vs. Ambient Temperature

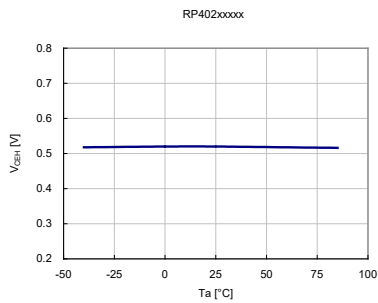

13) MODE "H" Input Voltage vs. Ambient Temperature

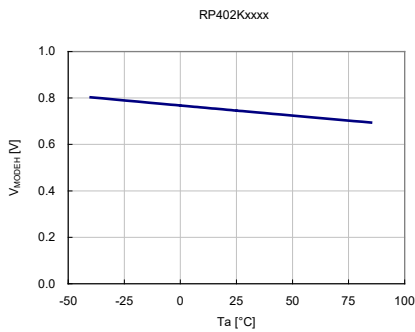

14) Output Voltage vs. Ambient Temperature

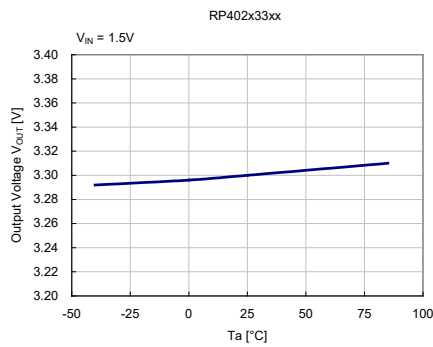

RP402x

No. EA-317-200604

15) Feedback Voltage vs. Ambient Temperature

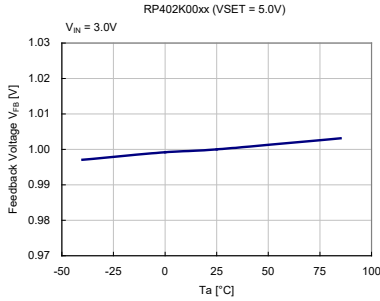

16) Start-up Waveform ($C_{OUT} = 20 \mu F$)

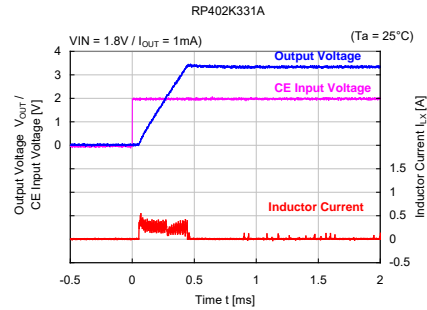
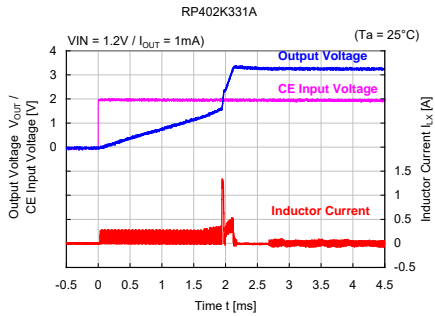

17) Load Transient Response ($C_{OUT} = 20 \mu F$)

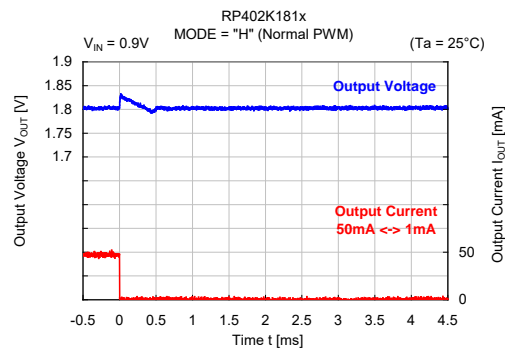
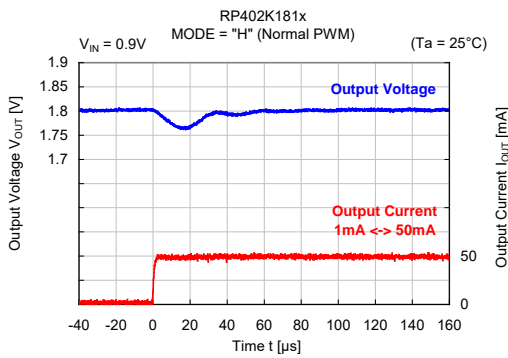
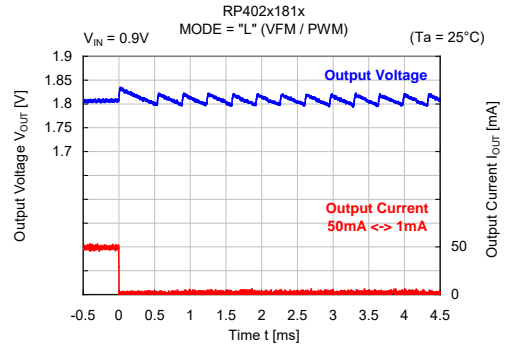
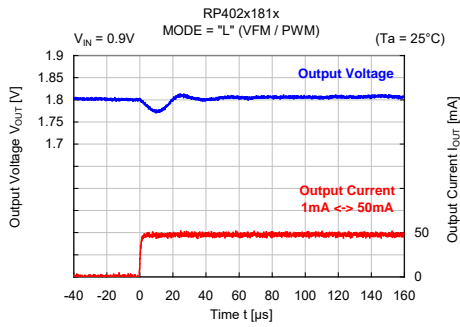

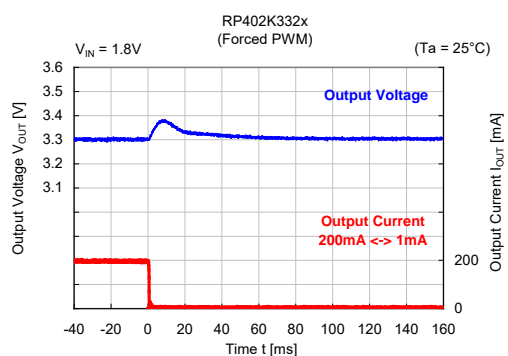
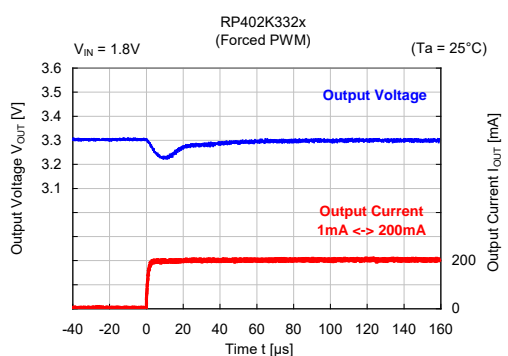
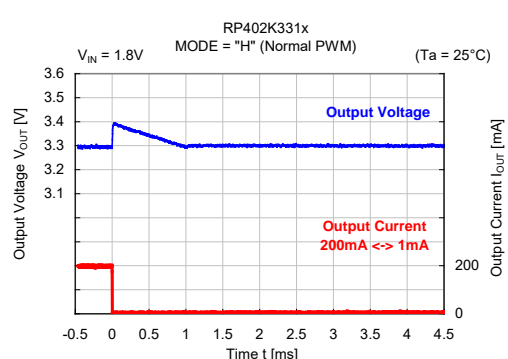
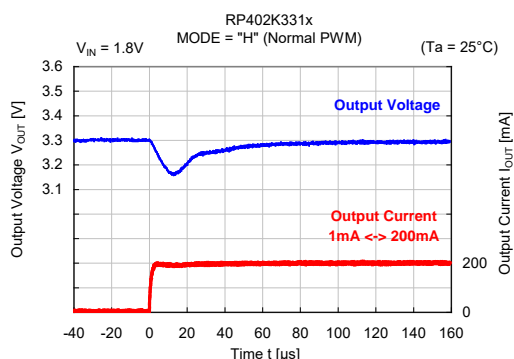
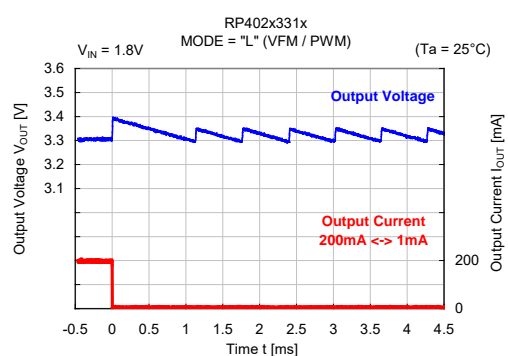
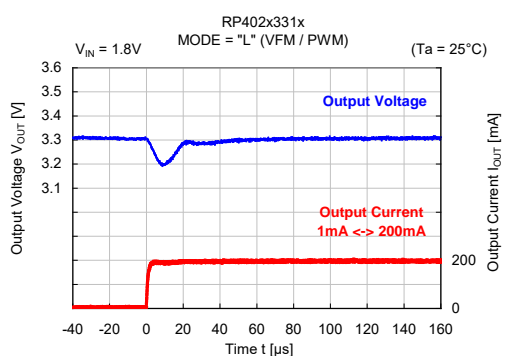
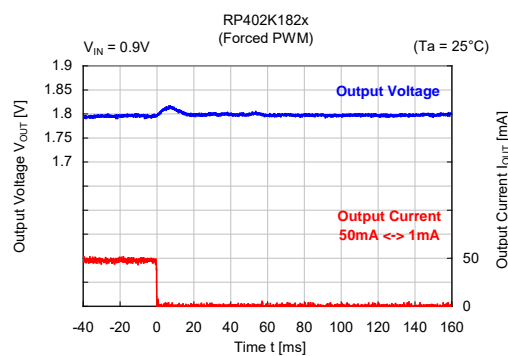
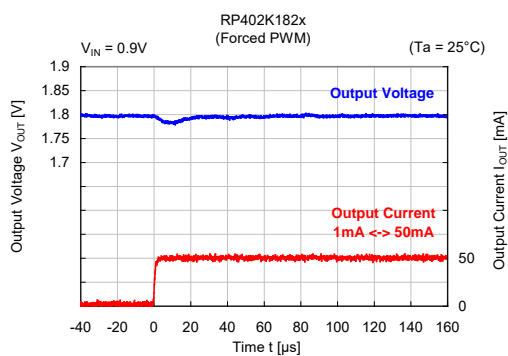

RP402x

No. EA-317-200604

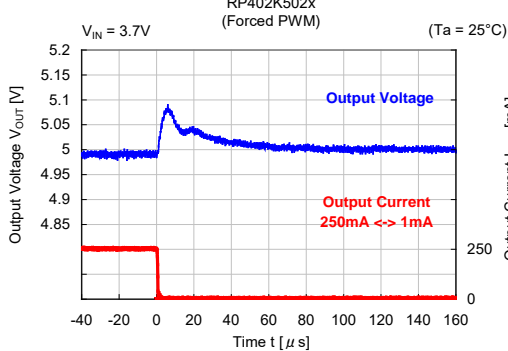
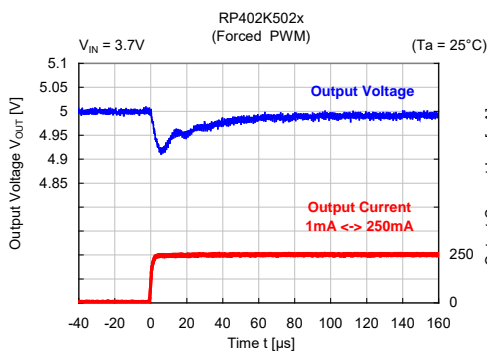
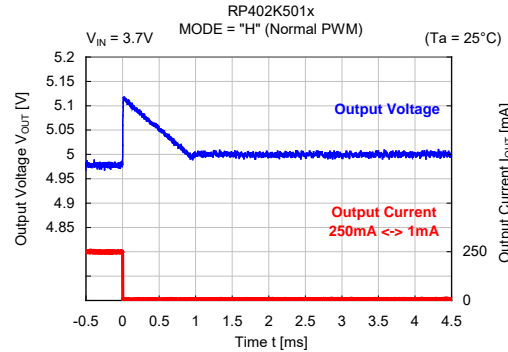
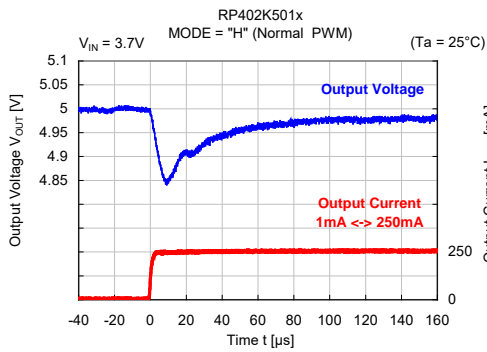
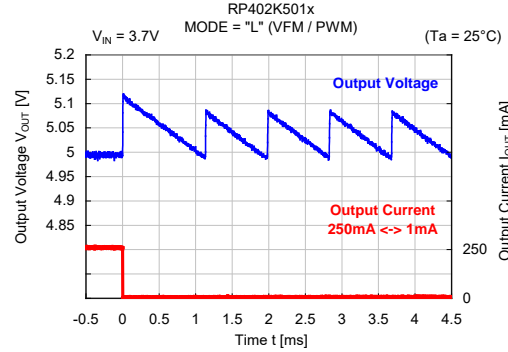
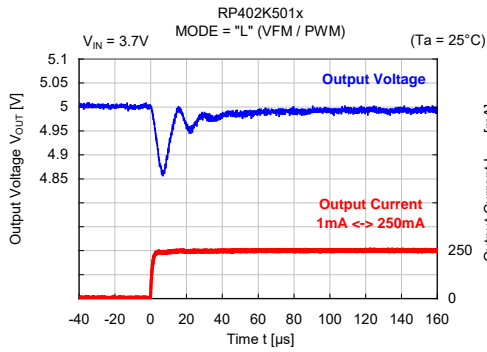

18) Output Voltage Waveform (C_{OUT} = 20 μF)

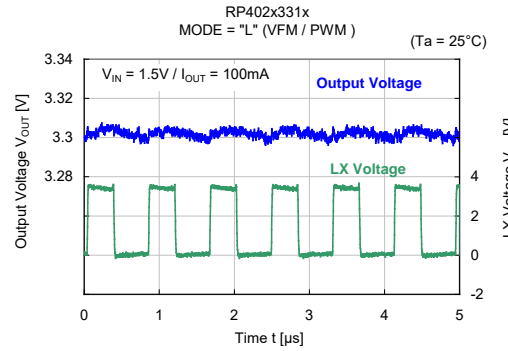
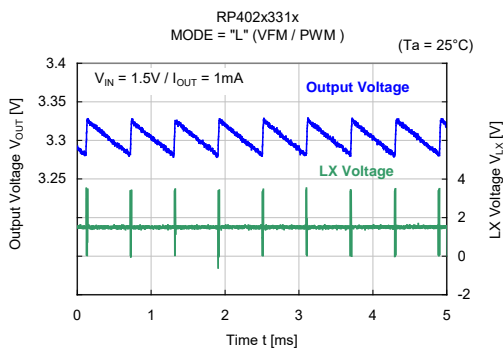

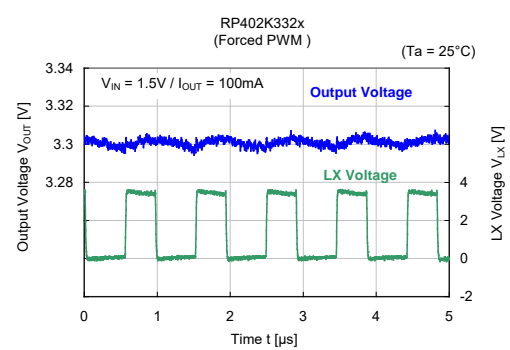
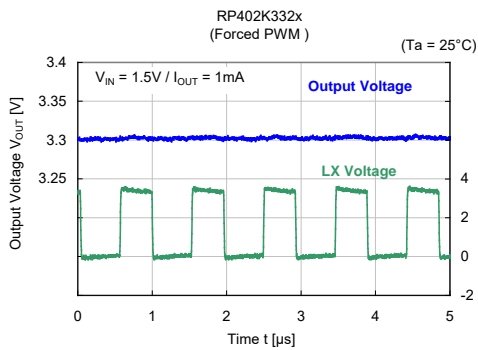
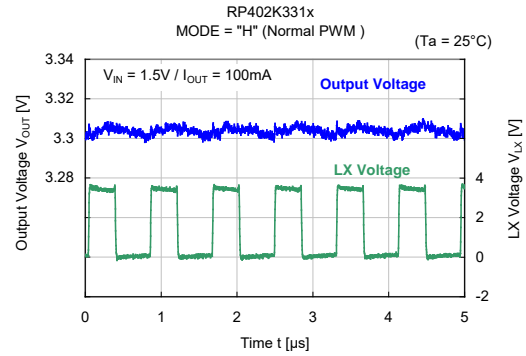
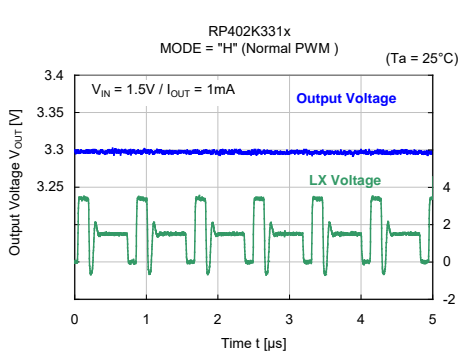

19) Mode Switching Waveform

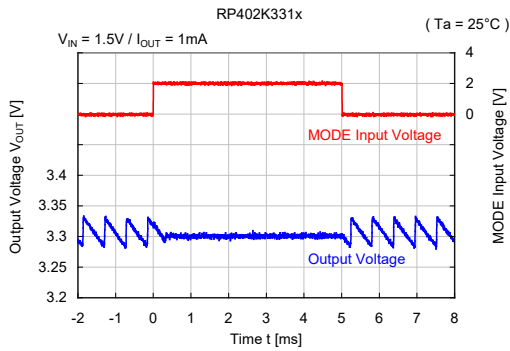

20) Bypass Switch ON Resistance

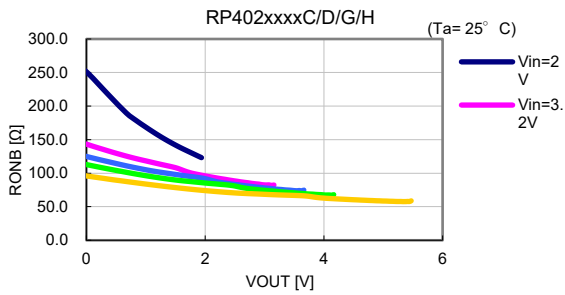

RP402x

No. EA-317-200604

21) PWM Operable Maximum Input Voltage vs. Ambient Temperature

RP402Kxx2x: (Forced PWM)

RP402Kxx1x: MODE = "H" (Normal PWM)

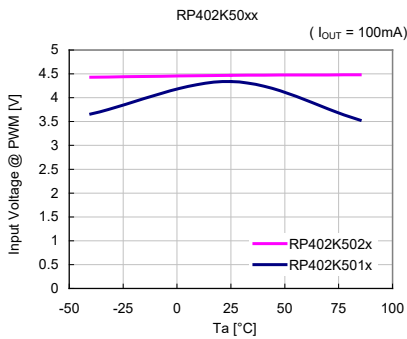
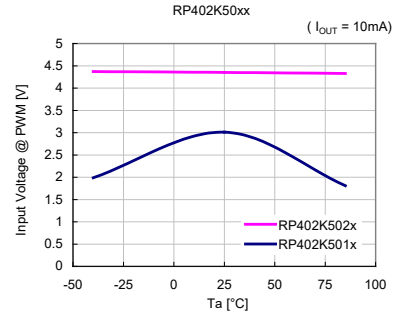
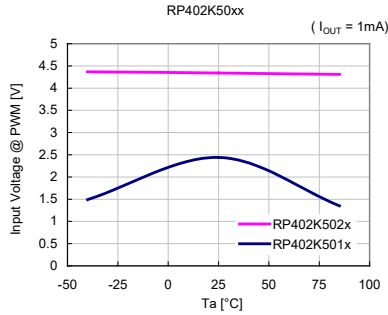

22) Reverse Current at $V_{IN} = 0$ vs. Ambient Temperature

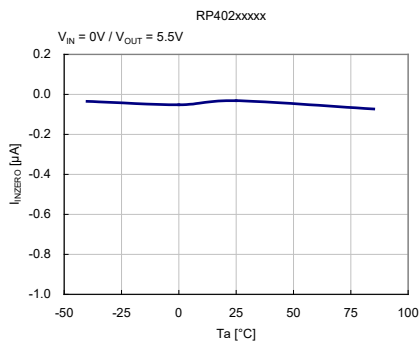

23) Latch Protection Delay Time vs. Ambient Temperature

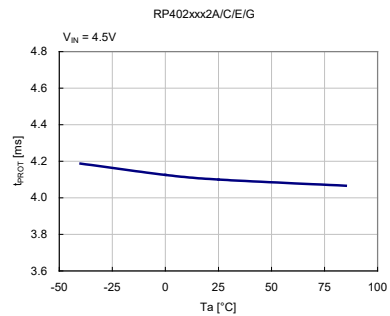
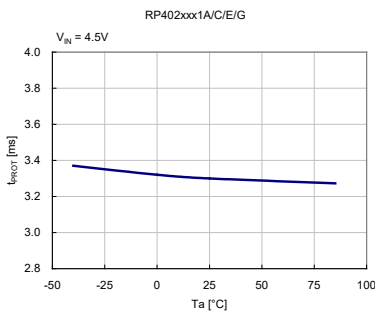

The power dissipation of the package is dependent on PCB material, layout, and environmental conditions. The following measurement conditions are based on JEDEC STD. 51-7.

Measurement Conditions

Item	Measurement Conditions
Environment	Mounting on Board (Wind Velocity = 0 m/s)
Board Material	Glass Cloth Epoxy Plastic (Four-Layer Board)
Board Dimensions	76.2 mm × 114.3 mm × 0.8 mm
Copper Ratio	Outer Layer (First Layer): Less than 95% of 50 mm Square Inner Layers (Second and Third Layers): Approx. 100% of 50 mm Square Outer Layer (Fourth Layer): Approx. 100% of 50 mm Square
Through-holes	φ 0.3 mm × 23 pcs

Measurement Result

(Ta = 25°C, Tjmax = 125°C)

Item	Measurement Result
Power Dissipation	1800 mW
Thermal Resistance (θja)	θja = 53°C/W
Thermal Characterization Parameter (ψjt)	ψjt = 27°C/W

θja: Junction-to-Ambient Thermal Resistance

ψjt: Junction-to-Top Thermal Characterization Parameter

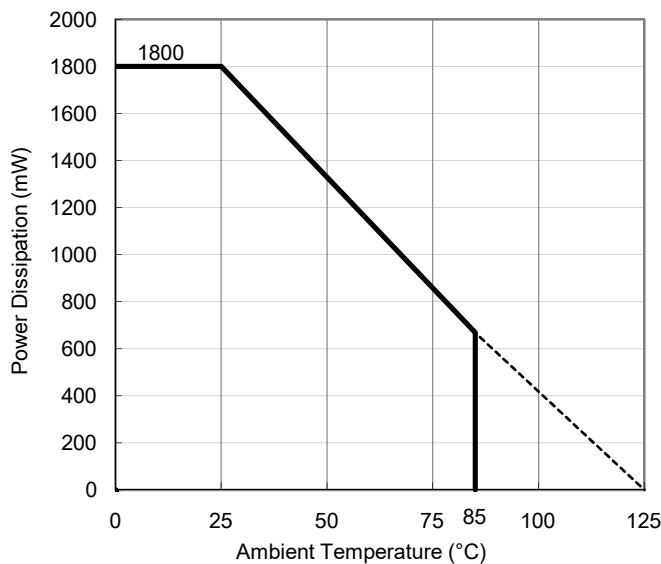

Power Dissipation vs. Ambient Temperature

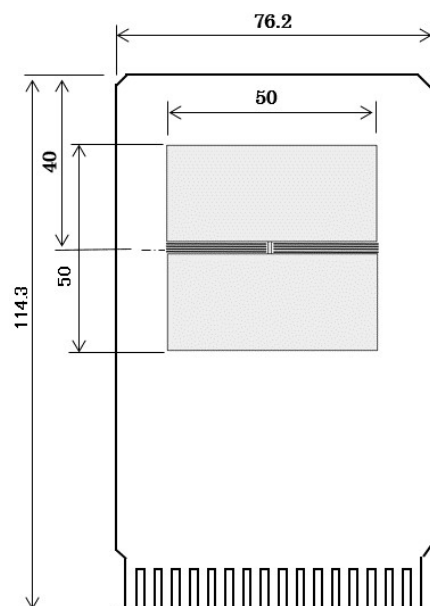

Measurement Board Pattern

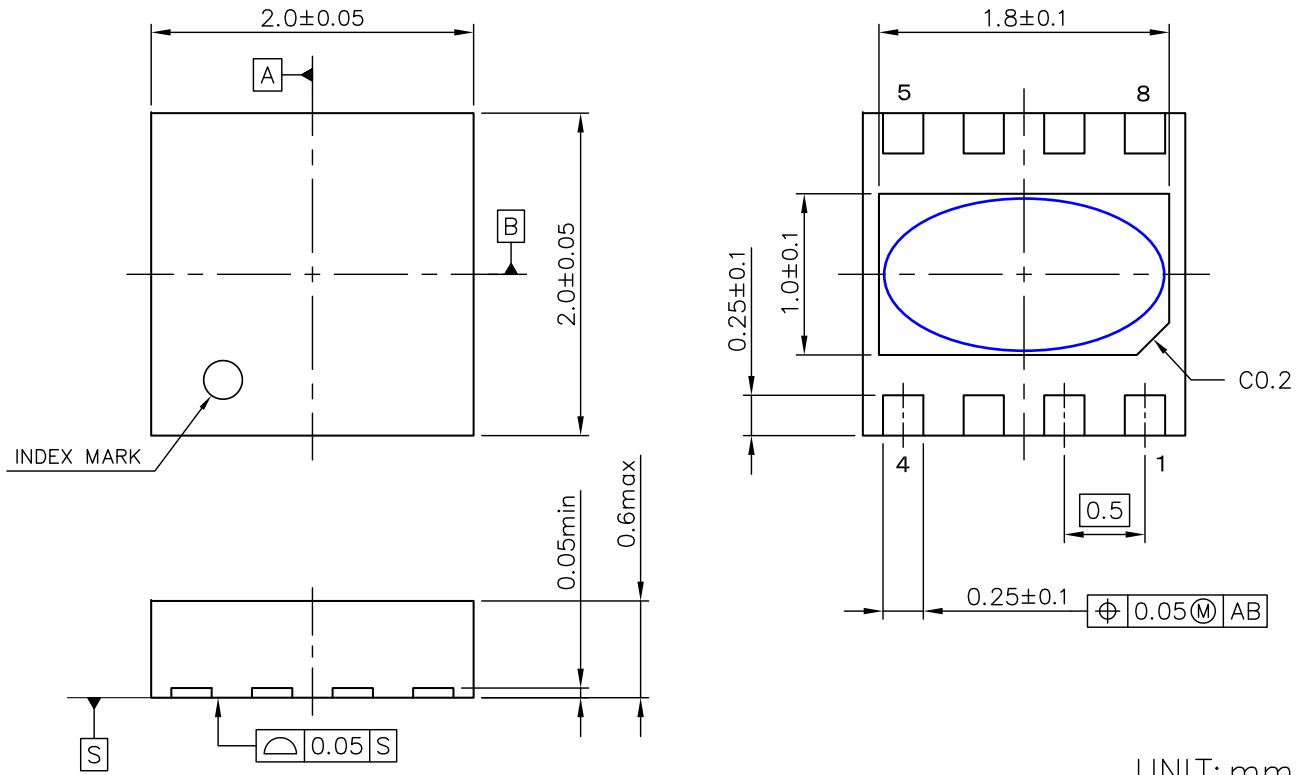

DFN (PL) 2020-8 Package Dimensions

* The tab on the bottom of the package shown by blue circle is a substrate potential (GND). It is recommended that this tab be connected to the ground plane on the board but it is possible to leave the tab floating.

The power dissipation of the package is dependent on PCB material, layout, and environmental conditions. The following measurement conditions are based on JEDEC STD. 51-7.

Measurement Conditions

Item	Measurement Conditions
Environment	Mounting on Board (Wind Velocity = 0 m/s)
Board Material	Glass Cloth Epoxy Plastic (Four-Layer Board)
Board Dimensions	76.2 mm × 114.3 mm × 0.8 mm
Copper Ratio	Outer Layer (First Layer): Less than 95% of 50 mm Square Inner Layers (Second and Third Layers): Approx. 100% of 50 mm Square Outer Layer (Fourth Layer): Approx. 100% of 50 mm Square
Through-holes	φ 0.3 mm × 7 pcs

Measurement Result

(Ta = 25°C, Tjmax = 125°C)

Item	Measurement Result
Power Dissipation	660 mW
Thermal Resistance (θja)	θja = 150°C/W
Thermal Characterization Parameter (ψjt)	ψjt = 51°C/W

θja: Junction-to-Ambient Thermal Resistance

ψjt: Junction-to-Top Thermal Characterization Parameter

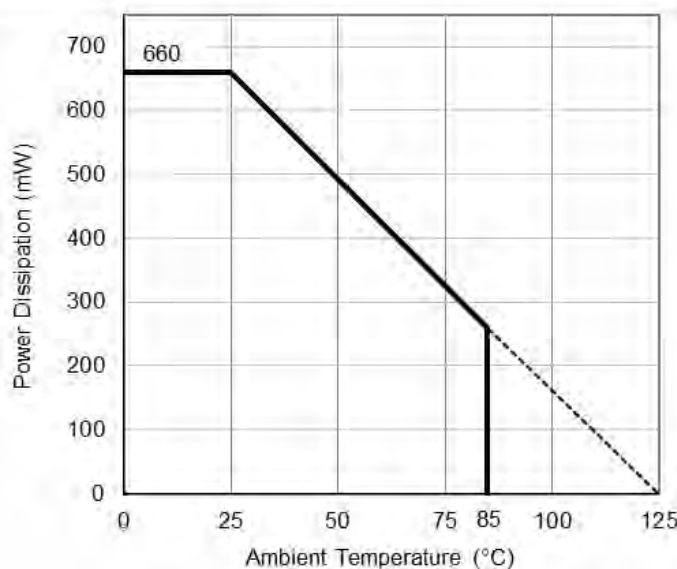

Power Dissipation vs. Ambient Temperature

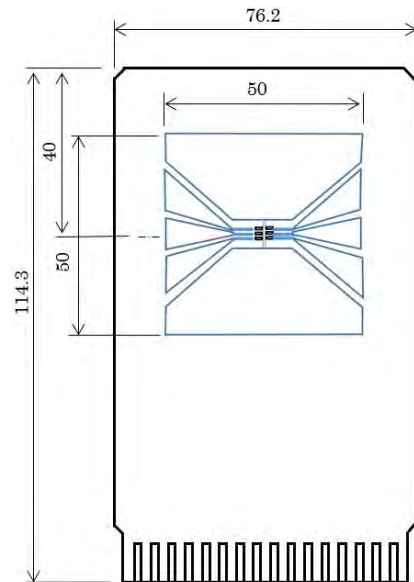

Measurement Board Pattern

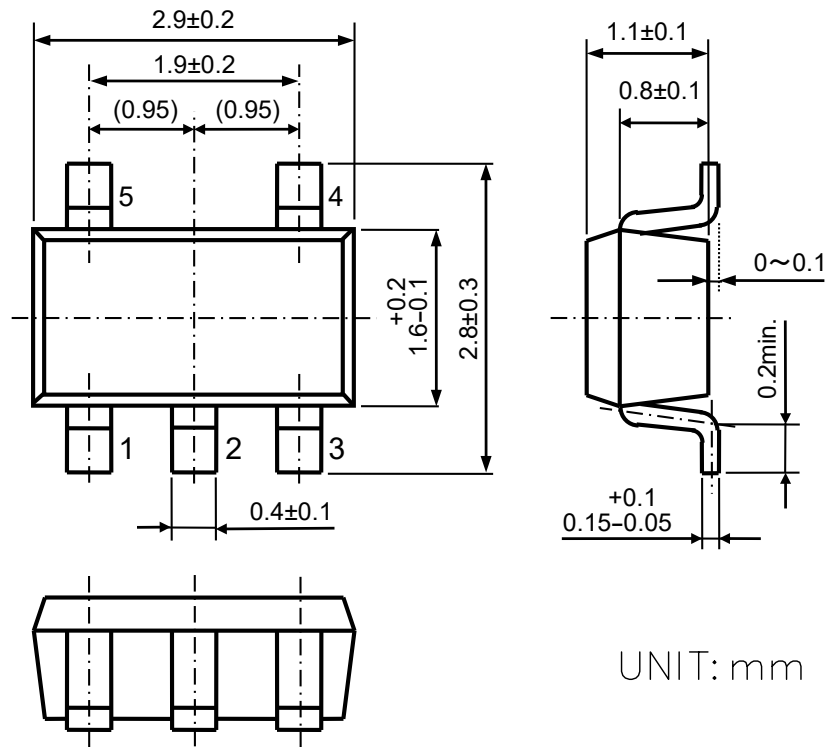

UNIT: mm

SOT-23-5 Package Dimensions



1. The products and the product specifications described in this document are subject to change or discontinuation of production without notice for reasons such as improvement. Therefore, before deciding to use the products, please refer to our sales representatives for the latest information thereon.
2. The materials in this document may not be copied or otherwise reproduced in whole or in part without prior written consent of our company.
3. Please be sure to take any necessary formalities under relevant laws or regulations before exporting or otherwise taking out of your country the products or the technical information described herein.
4. The technical information described in this document shows typical characteristics of and example application circuits for the products. The release of such information is not to be construed as a warranty of or a grant of license under our company's or any third party's intellectual property rights or any other rights.
5. The products listed in this document are intended and designed for use as general electronic components in standard applications (office equipment, telecommunication equipment, measuring instruments, consumer electronic products, amusement equipment etc.). Those customers intending to use a product in an application requiring extreme quality and reliability, for example, in a highly specific application where the failure or misoperation of the product could result in human injury or death (aircraft, spacevehicle, nuclear reactor control system, traffic control system, automotive and transportation equipment, combustion equipment, safety devices, life support system etc.) should first contact us.
6. We are making our continuous effort to improve the quality and reliability of our products, but semiconductor products are likely to fail with certain probability. In order to prevent any injury to persons or damages to property resulting from such failure, customers should be careful enough to incorporate safety measures in their design, such as redundancy feature, fire containment feature and fail-safe feature. We do not assume any liability or responsibility for any loss or damage arising from misuse or inappropriate use of the products.
7. Anti-radiation design is not implemented in the products described in this document.
8. The X-ray exposure can influence functions and characteristics of the products. Confirm the product functions and characteristics in the evaluation stage.
9. WLCSP products should be used in light shielded environments. The light exposure can influence functions and characteristics of the products under operation or storage.
10. There can be variation in the marking when different AOI (Automated Optical Inspection) equipment is used. In the case of recognizing the marking characteristic with AOI, please contact our sales or our distributor before attempting to use AOI.
11. Please contact our sales representatives should you have any questions or comments concerning the products or the technical information.



Nisshinbo Micro Devices Inc.

Official website

<https://www.nisshinbo-microdevices.co.jp/en/>

Purchase information

<https://www.nisshinbo-microdevices.co.jp/en/buy/>



Mouser Electronics

Authorized Distributor

Click to View Pricing, Inventory, Delivery & Lifecycle Information:

Nisshinbo Micro Devices:

[RP402K502A-TR](#) [RP402N501E-TR-FE](#) [RP402K001A-TR](#) [RP402K001B-TR](#) [RP402K502B-TR](#) [RP402K332A-TR](#)
[RP402K181C-TR](#) [RP402K001C-TR](#) [RP402K001D-TR](#) [RP402K551A-TR](#) [RP402K552A-TR](#) [RP402K501B-TR](#)
[RP402K501A-TR](#) [RP402N181E-TR-FE](#) [RP402N331E-TR-FE](#) [RP402K002B-TR](#) [RP402K331A-TR](#) [RP402N501F-TR-](#)
[FE](#) [RP402N501H-TR-FE](#) [RP402K331B-TR](#) [RP402N331F-TR-FE](#) [RP402N301F-TR-FE](#) [RP402K002A-TR](#)
[RP402K281C-TR](#) [RP402K391B-TR](#) [RP402K461B-TR](#) [RP402K512B-TR](#) [RP402N231F-TR-FE](#) [RP402N301H-TR-FE](#)
[RP402N331H-TR-FE](#) [RP402N361E-TR-FE](#) [RP402K382A-TR](#) [RP402K532A-TR](#) [RP402N391E-TR-FE](#)