

ECS-MPIL0530

SMD Power Inductor

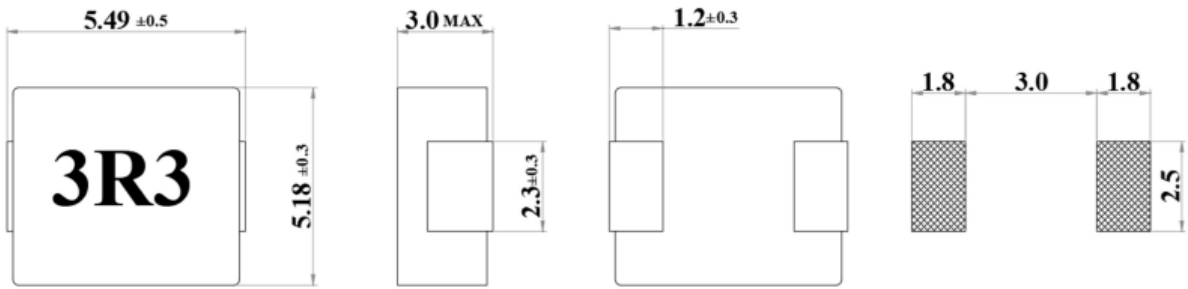

## 1. Mechanical Dimension [Unit : mm]



## 2. Electrical Characteristics

### ECS-MPIL0530 Series

Part No.	Inductance ( $\mu\text{H} \pm 20\%$ )	DC Resistance ( $\text{m}\Omega$ MAX)	DC Resistance ( $\text{m}\Omega$ TYP.)	Rated Current (A MAX)	Heat Rating Current DC(A)
ECS-MPIL0530-R68MC	0.68	12	11	14.0	8.5
ECS-MPIL0530-1R0MC	1.0	14	13	11.0	7.0
ECS-MPIL0530-1R5MC	1.5	25	20	10.0	6.0
ECS-MPIL0530-2R2MC	2.2	35	29	9.0	5.5
ECS-MPIL0530-3R3MC	3.3	38	32	7.0	5.0
ECS-MPIL0530-4R7MC	4.7	60	50	5.0	3.0
ECS-MPIL0530-5R6MC	5.6	75	62	5.0	3.8
ECS-MPIL0530-220MC	22	324	270	3.0	2.0

Storage and Operating Temperature:  $-40 \sim +125 \text{ }^\circ\text{C}$

Measuring Frequency (L) : 100KHz/0.1V

Rated Current: D.C. Current at which the Inductance drops 30%(MAX.) from its value without current

**ECS-MPIL0530-R68MC**

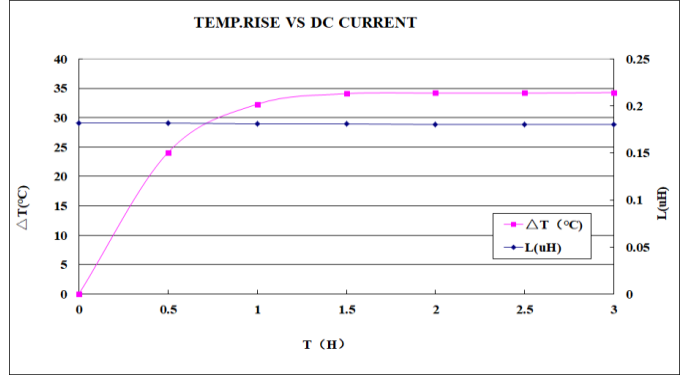
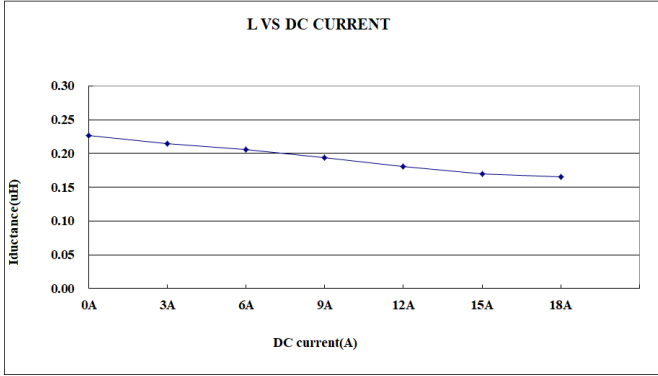

**ECS-MPIL0530-1R0MC**

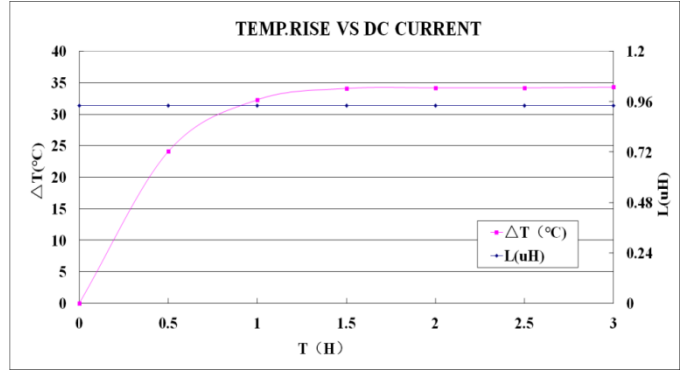
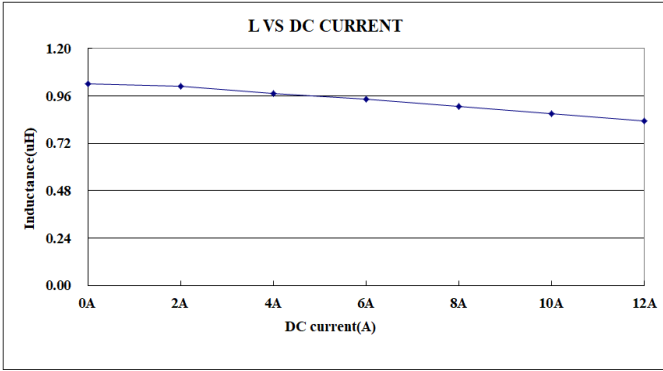

**ECS-MPIL0530-1R5MC**

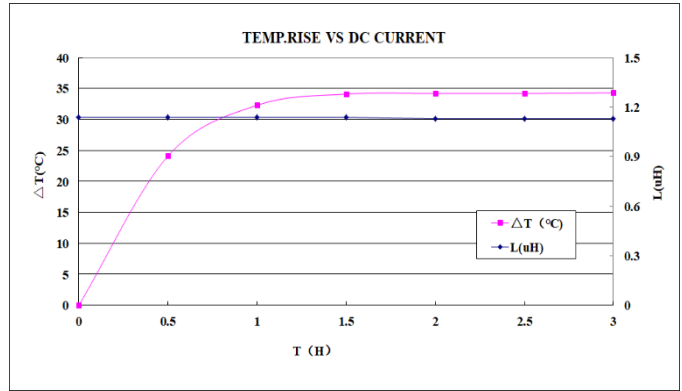
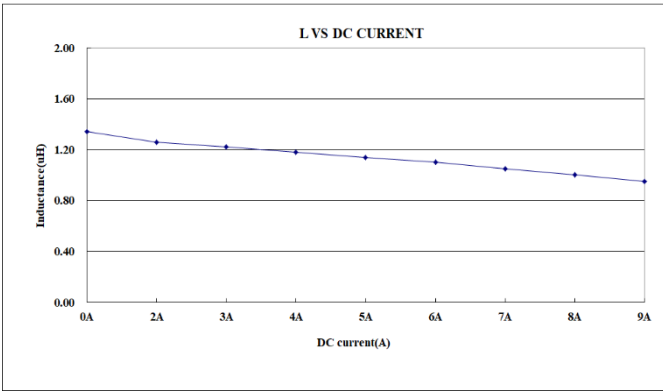

**ECS-MPIL0530-2R2MC**

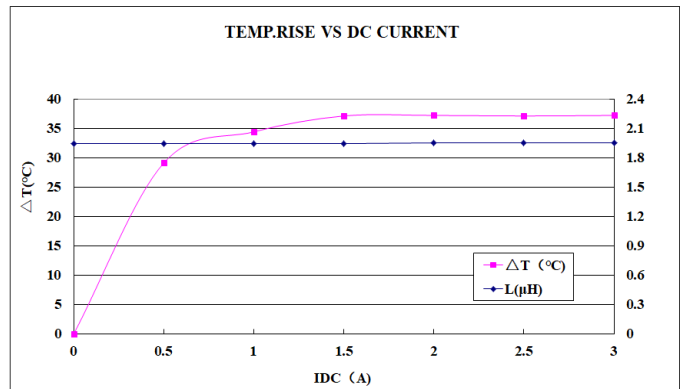
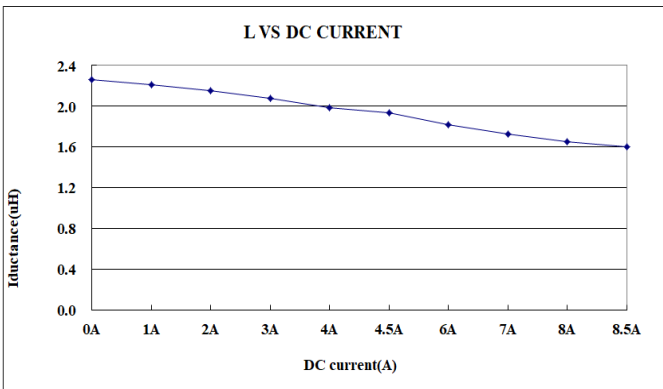

**ECS-MPIL0530-3R3MC**

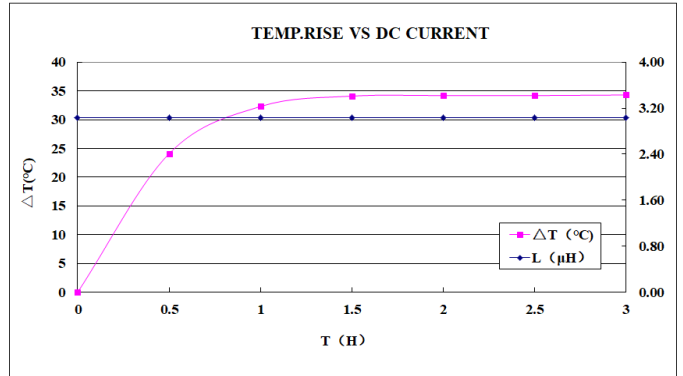
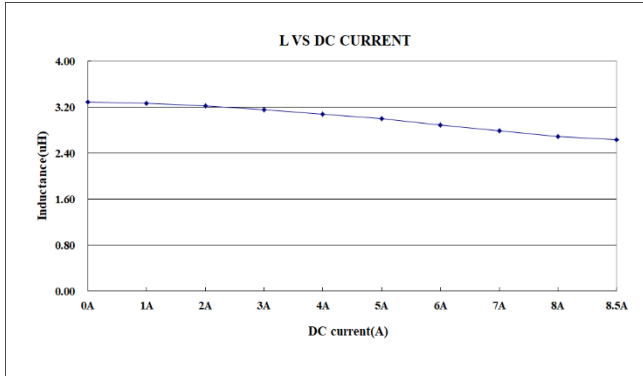

**ECS-MPIL0530-4R7MC**

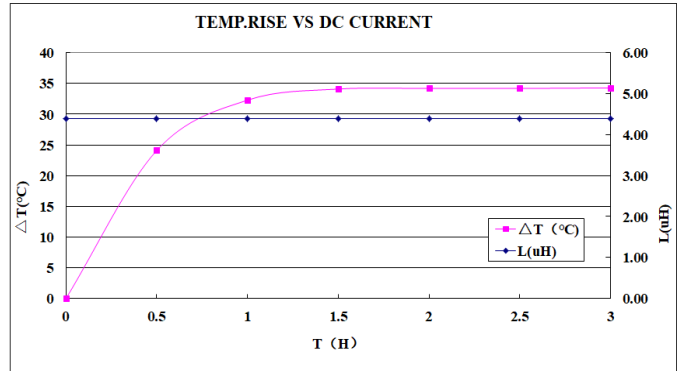
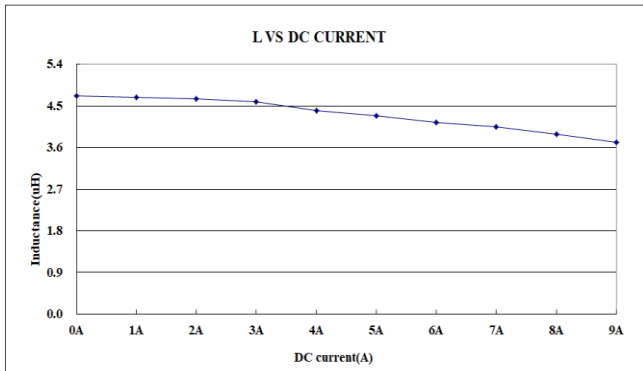

**ECS-MPIL0530-6R8MC**

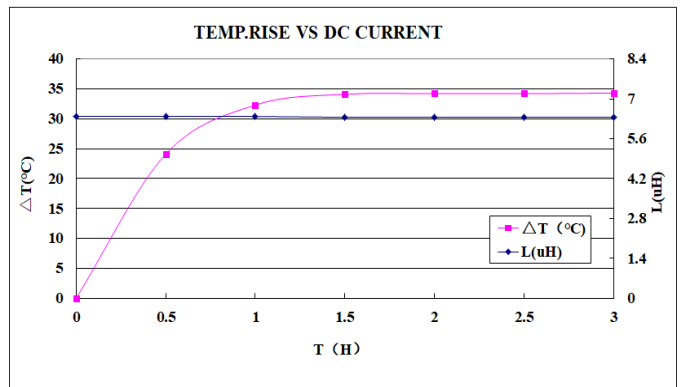
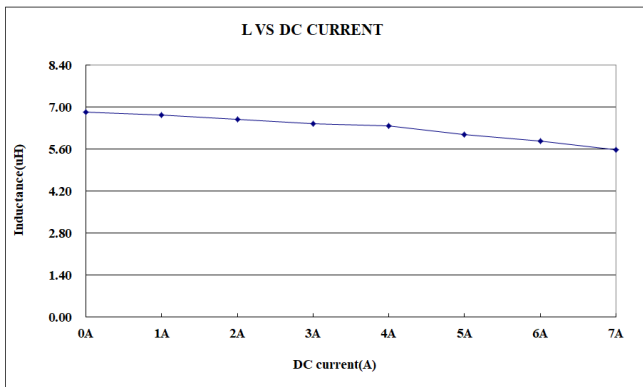

**ECS-MPIL0530-220MC**

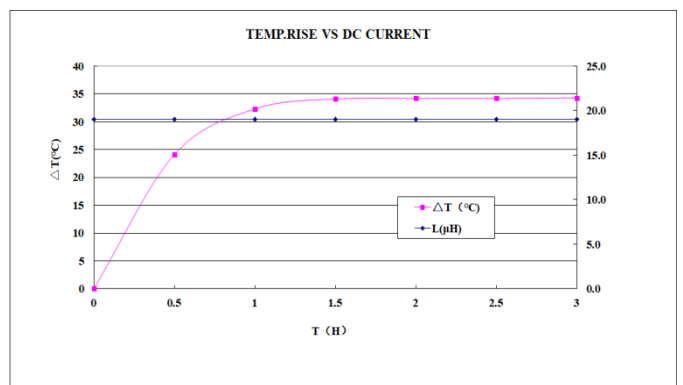
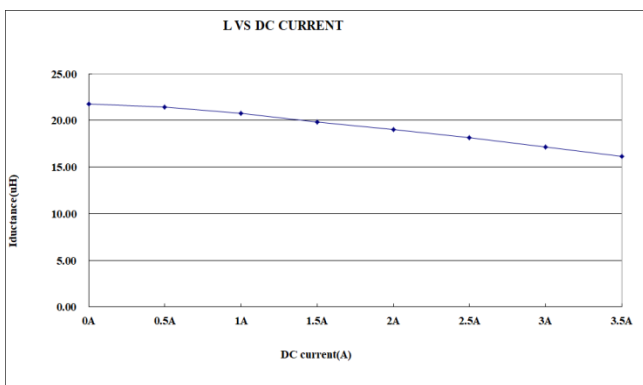

## 7. REEL DIMENSION (mm)

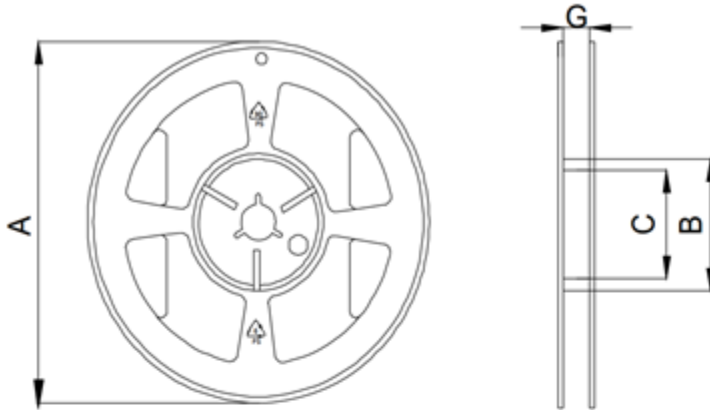

A	B	C	G
330	100	13	16

## 8. EMBOSSED TAPE DIMENSIONS (mm)

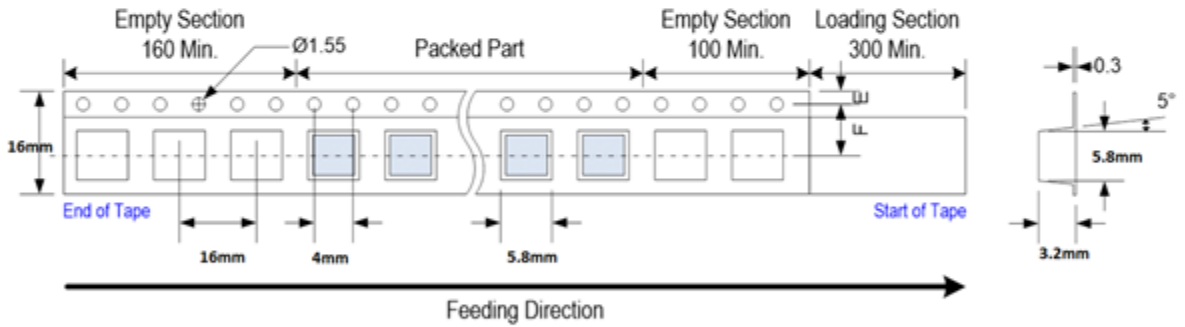

## 9. PEEL-OFF STRENGTH

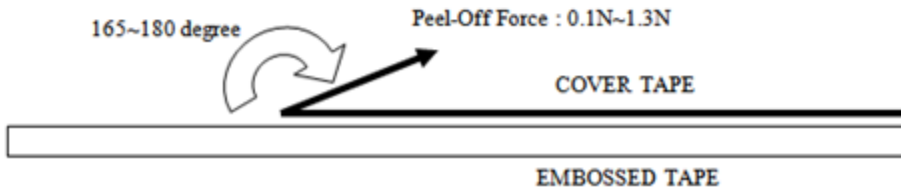

# Mouser Electronics

Authorized Distributor

Click to View Pricing, Inventory, Delivery & Lifecycle Information:

[ECS:](#)

[ECS-MPIL0530-2R2MC](#) [ECS-MPIL0530-5R6MC](#) [ECS-MPIL0530-1R5MC](#) [ECS-MPIL0530-4R7MC](#) [ECS-MPIL0530-3R3MC](#)