

## 3-TERMINAL NEGATIVE VOLTAGE REGULATOR

### ■ FEATURES

- Full Compatible with NJM79L00UA
- Output Current 100 mA
- Output Voltage Accuracy  $V_O \pm 4.0\%$
- Operating Temperature  $T_a = -40^\circ\text{C}$  to  $125^\circ\text{C}$
- High Ripple Rejection
- Overcurrent Protection
- Thermal Shutdown
- Bipolar Process
- Package SOT-89-3

### ■ APPLICATIONS

- Industrial Equipment
- OA Equipment
- Consumer Equipment

### ■ DESCRIPTION

The NJM79L00S series negative voltage regulators deliver up to 100 mA of output current.

This series is enabling to direct replacement from NJM79L00UA series.

These devices offer improved usability by extending the operating temperature and maximum input voltage. This series is available in a SOT-89-3 package and is specified over the industrial temperature range of  $-40^\circ\text{C}$  to  $125^\circ\text{C}$ .

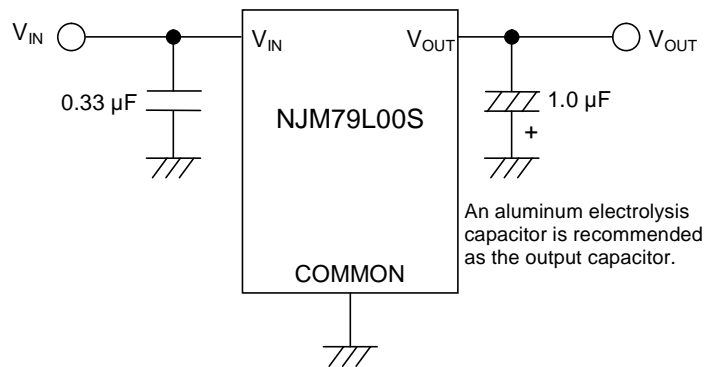

### ■ TYPICAL APPLICATION

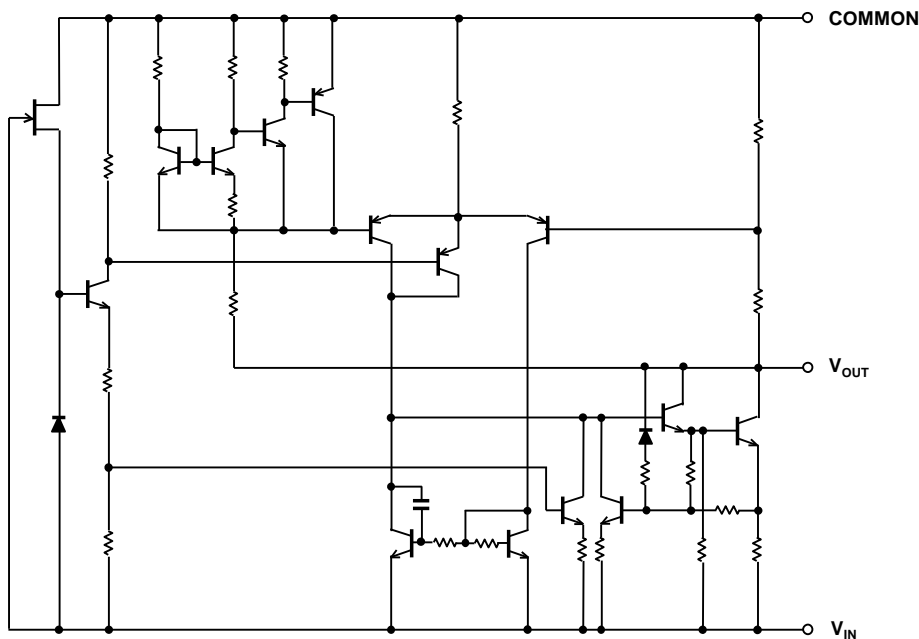

### ■ EQUIVALENT CIRCUIT



## ■ PIN CONFIGURATIONS

PIN FUNCTIONS	PIN NO.	SYMBOL	DESCRIPTION
COMMON 1 	1	COMMON	Common pin
$V_{IN}$ 2 	2	$V_{IN}$	Input pin
$V_{OUT}$ 3 	3	$V_{OUT}$	Output pin

## ■ PRODUCT NAME INFORMATION

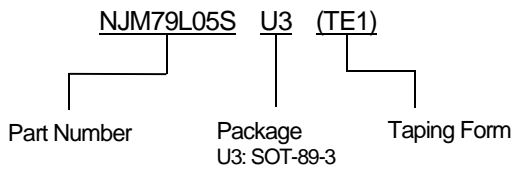

## ■ ORDERING INFORMATION

PRODUCT NAME	OUTPUT VOLTAGE	PACKAGE	RoHS	HALOGEN-FREE	TERMINAL FINISH	MARKING	WEIGHT (mg)	MOQ (pcs)
NJM79L05SU3 (TE1)	-5.0 V	SOT-89-3	Yes	Yes	Sn-2Bi	111	61	1000
NJM79L06SU3 (TE1)	-6.0 V	SOT-89-3	Yes	Yes	Sn-2Bi	121	61	1000
NJM79L08SU3 (TE1)	-8.0 V	SOT-89-3	Yes	Yes	Sn-2Bi	131	61	1000
NJM79L09SU3 (TE1)	-9.0 V	SOT-89-3	Yes	Yes	Sn-2Bi	141	61	1000
NJM79L12SU3 (TE1)	-12 V	SOT-89-3	Yes	Yes	Sn-2Bi	151	61	1000
NJM79L15SU3 (TE1)	-15 V	SOT-89-3	Yes	Yes	Sn-2Bi	161	61	1000

## ■ ABSOLUTE MAXIMUM RATINGS

PARAMETER	SYMBOL	RATING	UNIT
Input Voltage	$V_{IN}$	+0.3 to -40	V
Output Voltage	$V_{OUT}$	+0.3 to $V_{IN}$ (-40) <sup>(1)</sup>	V
Power Dissipation (Ta = 25°C) SOT-89-3	$P_D$	2-Layer <sup>(2)</sup> / 4-Layer <sup>(3)</sup> 580 / 2200	mW
Junction Temperature	$T_J$	-40 to 150	°C
Operating Temperature	$T_{opr}$	-40 to 125	°C
Storage Temperature	$T_{stg}$	-50 to 150	°C

(1) Although the terminal rating is -40 V, the output voltage must not exceed the input voltage.

(2) 2-Layer: Mounted on glass epoxy board (76.2 mm × 114.3 mm × 1.6 mm: based on EIA/JEDEC standard, 2-layer FR-4).

(3) 4-Layer: Mounted on glass epoxy board (76.2 mm × 114.3 mm × 1.6 mm: based on EIA/JEDEC standard, 4-layer FR-4).

(For 4-layer: Applying 74.2 mm × 74.2 mm inner Cu area and a thermal via hole to a board based on JEDEC standard JESD51-5.)

## ■ RECOMMENDED OPERATING CONDITIONS

PARAMETER	SYMBOL	VALUE	UNIT
Operating Voltage	$V_{IN}$	$V_O - 2.0$ to -30	V
Output Current	$I_O$	0 to 100	mA

## ■ ELECTRICAL CHARACTERISTICS

$C_{IN} = 0.33 \mu\text{F}$ ,  $C_O = 1.0 \mu\text{F}$ ,  $T_J = 25^\circ\text{C}$ , unless otherwise noted.

PARAMETER	SYMBOL	TEST CONDITIONS	MIN	TYP	MAX	UNIT
<b>NJM79L05S</b>						
Output Voltage	$V_O$	$V_{IN} = -10 \text{ V}$ , $I_O = 40 \text{ mA}$	-4.80	-5.00	-5.20	V
Line Regulation	$\Delta V_O - V_{IN}$	$V_{IN} = -7 \text{ V to } -20 \text{ V}$ , $I_O = 40 \text{ mA}$	-	15	100	mV
Load Regulation	$\Delta V_O - I_O$	$V_{IN} = -10 \text{ V}$ , $I_O = 1 \text{ mA to } 100 \text{ mA}$	-	7	50	mV
Quiescent Current	$I_Q$	$V_{IN} = -10 \text{ V}$ , $I_O = 0 \text{ mA}$	-	3.5	6.0	mA
Dropout Voltage	$\Delta V_{IO}$	$I_O = 100 \text{ mA}$	-	1.6	2.0	V
Ripple Rejection	RR	$V_{IN} = -8 \text{ V to } -18 \text{ V}$ , $I_O = 40 \text{ mA}$ , $e_{in} = 1 \text{ V}_{PP}$ , $f = 120 \text{ Hz}$	41	76	-	dB
Output Noise Voltage	$V_{NO}$	$V_{IN} = -10 \text{ V}$ , $BW = 10 \text{ Hz to } 100 \text{ kHz}$ , $I_O = 40 \text{ mA}$	-	110	-	$\mu\text{V}$
<b>NJM79L06S</b>						
Output Voltage	$V_O$	$V_{IN} = -12 \text{ V}$ , $I_O = 40 \text{ mA}$	-5.76	-6.00	-6.24	V
Line Regulation	$\Delta V_O - V_{IN}$	$V_{IN} = -8.5 \text{ V to } -20 \text{ V}$ , $I_O = 40 \text{ mA}$	-	18	100	mV
Load Regulation	$\Delta V_O - I_O$	$V_{IN} = -12 \text{ V}$ , $I_O = 1 \text{ mA to } 100 \text{ mA}$	-	8	60	mV
Quiescent Current	$I_Q$	$V_{IN} = -12 \text{ V}$ , $I_O = 0 \text{ mA}$	-	3.5	6.0	mA
Dropout Voltage	$\Delta V_{IO}$	$I_O = 100 \text{ mA}$	-	1.6	2.0	V
Ripple Rejection	RR	$V_{IN} = -9 \text{ V to } -19 \text{ V}$ , $I_O = 40 \text{ mA}$ , $e_{in} = 1 \text{ V}_{PP}$ , $f = 120 \text{ Hz}$	40	71	-	dB
Output Noise Voltage	$V_{NO}$	$V_{IN} = -12 \text{ V}$ , $BW = 10 \text{ Hz to } 100 \text{ kHz}$ , $I_O = 40 \text{ mA}$	-	140	-	$\mu\text{V}$
<b>NJU79L08S</b>						
Output Voltage	$V_O$	$V_{IN} = -14 \text{ V}$ , $I_O = 40 \text{ mA}$	-7.68	-8.00	-8.32	V
Line Regulation	$\Delta V_O - V_{IN}$	$V_{IN} = -10.5 \text{ V to } -23 \text{ V}$ , $I_O = 40 \text{ mA}$	-	24	120	mV
Load Regulation	$\Delta V_O - I_O$	$V_{IN} = -14 \text{ V}$ , $I_O = 1 \text{ mA to } 100 \text{ mA}$	-	10	70	mV
Quiescent Current	$I_Q$	$V_{IN} = -14 \text{ V}$ , $I_O = 0 \text{ mA}$	-	3.5	6.0	mA
Dropout Voltage	$\Delta V_{IO}$	$I_O = 100 \text{ mA}$	-	1.6	2.0	V
Ripple Rejection	RR	$V_{IN} = -11 \text{ V to } -21 \text{ V}$ , $I_O = 40 \text{ mA}$ , $e_{in} = 1 \text{ V}_{PP}$ , $f = 120 \text{ Hz}$	39	69	-	dB
Output Noise Voltage	$V_{NO}$	$V_{IN} = -14 \text{ V}$ , $BW = 10 \text{ Hz to } 100 \text{ kHz}$ , $I_O = 40 \text{ mA}$	-	190	-	$\mu\text{V}$
<b>NJM79L09S</b>						
Output Voltage	$V_O$	$V_{IN} = -15 \text{ V}$ , $I_O = 40 \text{ mA}$	-8.64	-9.00	-9.36	V
Line Regulation	$\Delta V_O - V_{IN}$	$V_{IN} = -11.5 \text{ V to } -24 \text{ V}$ , $I_O = 40 \text{ mA}$	-	27	140	mV
Load Regulation	$\Delta V_O - I_O$	$V_{IN} = -15 \text{ V}$ , $I_O = 1 \text{ mA to } 100 \text{ mA}$	-	12	75	mV
Quiescent Current	$I_Q$	$V_{IN} = -15 \text{ V}$ , $I_O = 0 \text{ mA}$	-	3.5	6.0	mA
Dropout Voltage	$\Delta V_{IO}$	$I_O = 100 \text{ mA}$	-	1.6	2.0	V
Ripple Rejection	RR	$V_{IN} = -12 \text{ V to } -22 \text{ V}$ , $I_O = 40 \text{ mA}$ , $e_{in} = 1 \text{ V}_{PP}$ , $f = 120 \text{ Hz}$	38	68	-	dB
Output Noise Voltage	$V_{NO}$	$V_{IN} = -15 \text{ V}$ , $BW = 10 \text{ Hz to } 100 \text{ kHz}$ , $I_O = 40 \text{ mA}$	-	210	-	$\mu\text{V}$
<b>NJM79L12S</b>						
Output Voltage	$V_O$	$V_{IN} = -19 \text{ V}$ , $I_O = 40 \text{ mA}$	-11.5	-12.0	-12.5	V
Line Regulation	$\Delta V_O - V_{IN}$	$V_{IN} = -14.5 \text{ V to } -27 \text{ V}$ , $I_O = 40 \text{ mA}$	-	36	170	mV
Load Regulation	$\Delta V_O - I_O$	$V_{IN} = -19 \text{ V}$ , $I_O = 1 \text{ mA to } 100 \text{ mA}$	-	16	85	mV
Quiescent Current	$I_Q$	$V_{IN} = -19 \text{ V}$ , $I_O = 0 \text{ mA}$	-	3.5	6.5	mA
Dropout Voltage	$\Delta V_{IO}$	$I_O = 100 \text{ mA}$	-	1.6	2.0	V
Ripple Rejection	RR	$V_{IN} = -15 \text{ V to } -25 \text{ V}$ , $I_O = 40 \text{ mA}$ , $e_{in} = 1 \text{ V}_{PP}$ , $f = 120 \text{ Hz}$	37	67	-	dB
Output Noise Voltage	$V_{NO}$	$V_{IN} = -19 \text{ V}$ , $BW = 10 \text{ Hz to } 100 \text{ kHz}$ , $I_O = 40 \text{ mA}$	-	290	-	$\mu\text{V}$

## ■ ELECTRICAL CHARACTERISTICS (continued)

$C_{IN} = 0.33 \mu\text{F}$ ,  $C_O = 1.0 \mu\text{F}$ ,  $T_J = 25^\circ\text{C}$ , unless otherwise noted.

PARAMETER	SYMBOL	TEST CONDITIONS	MIN	TYP	MAX	UNIT
<b>NJM79L15S</b>						
Output Voltage	$V_O$	$V_{IN} = -23 \text{ V}$ , $I_O = 40 \text{ mA}$	-14.4	-15.0	-15.6	V
Line Regulation	$\Delta V_O - V_{IN}$	$V_{IN} = -17.5 \text{ V to } -30 \text{ V}$ , $I_O = 40 \text{ mA}$	-	45	200	mV
Load Regulation	$\Delta V_O - I_O$	$V_{IN} = -23 \text{ V}$ , $I_O = 1 \text{ mA to } 100 \text{ mA}$	-	20	125	mV
Quiescent Current	$I_Q$	$V_{IN} = -23 \text{ V}$ , $I_O = 0 \text{ mA}$	-	3.5	6.5	mA
Dropout Voltage	$\Delta V_{IO}$	$I_O = 100 \text{ mA}$	-	1.6	2.0	V
Ripple Rejection	RR	$V_{IN} = -18.5 \text{ V to } -28.5 \text{ V}$ , $I_O = 40 \text{ mA}$ , $e_{in} = 1 \text{ V}_{P-P}$ , $f = 120 \text{ Hz}$	34	64	-	dB
Output Noise Voltage	$V_{NO}$	$V_{IN} = -23 \text{ V}$ , $BW = 10 \text{ Hz to } 100 \text{ kHz}$ , $I_O = 40 \text{ mA}$	-	340	-	$\mu\text{V}$

## ■ THERMAL CHARACTERISTICS

PARAMETER	SYMBOL	VALUE	UNIT
Junction-to-Ambient Thermal Resistance SOT-89-3	$\theta_{ja}$	2-Layer <sup>(4)</sup> / 4-Layer <sup>(5)</sup> 215 / 58	$^\circ\text{C/W}$
Junction-to-Top of Package Characterization Parameter SOT-89-3	$\Psi_{jt}$	2-Layer <sup>(4)</sup> / 4-Layer <sup>(5)</sup> 40 / 19	$^\circ\text{C/W}$

## ■ POWER DISSIPATION vs. AMBIENT TEMPERATURE

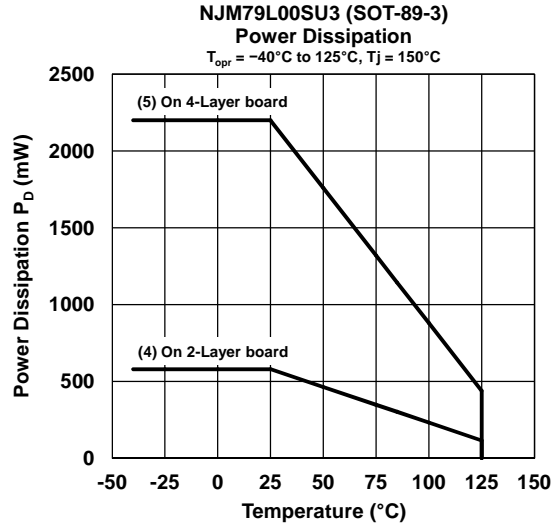

(4) 2-Layer: Mounted on glass epoxy board (76.2 mm × 114.3 mm × 1.6 mm: based on EIA/JEDEC standard, 2-layer FR-4).

(5) 4-Layer: Mounted on glass epoxy board (76.2 mm × 114.3 mm × 1.6 mm: based on EIA/JEDEC standard, 4-layer FR-4).

(For 4-layer: Applying 74.2 mm × 74.2 mm inner Cu area and a thermal via hole to a board based on JEDEC standard JESD51-5.)

## ■ -5V TYPICAL CHARACTERISTICS

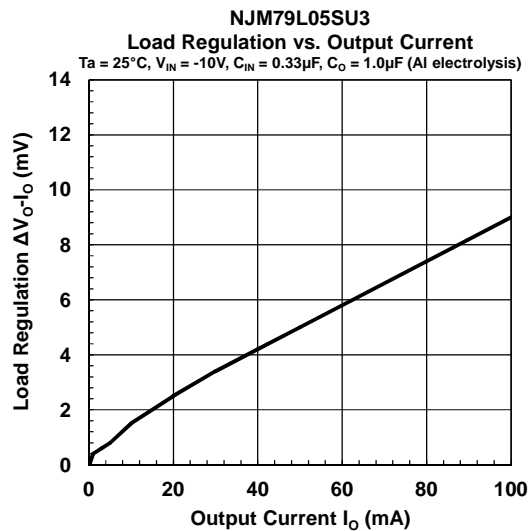
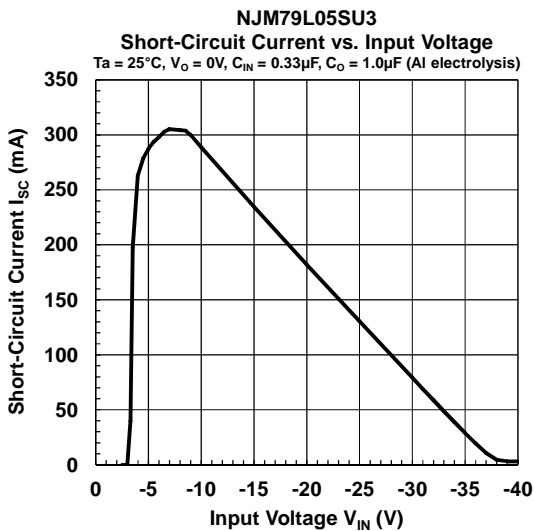
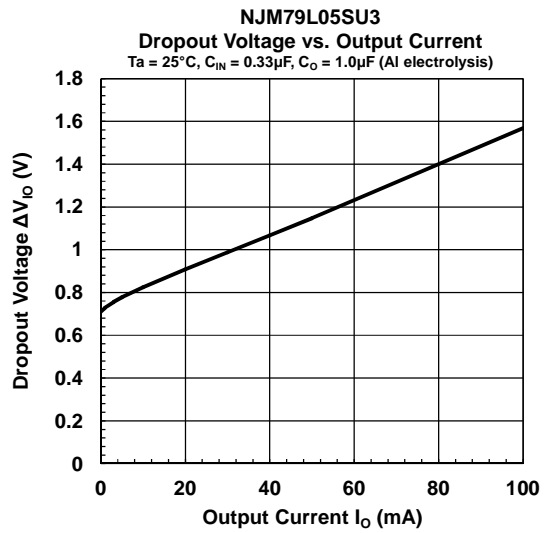
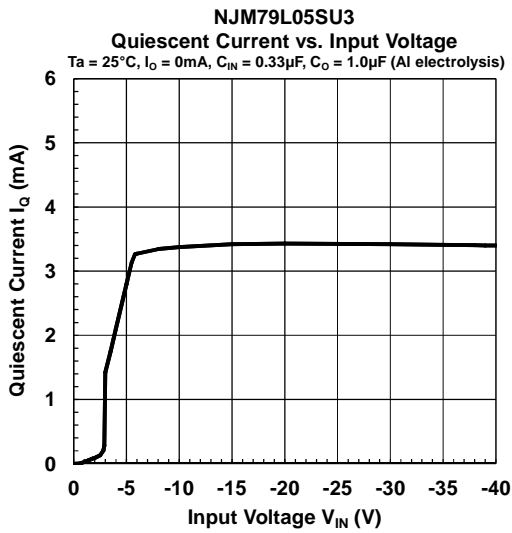
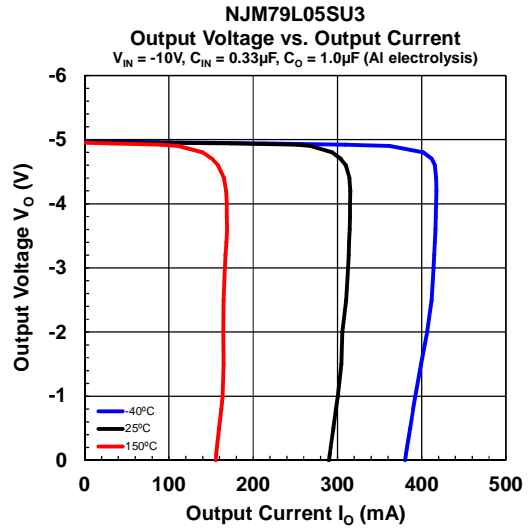
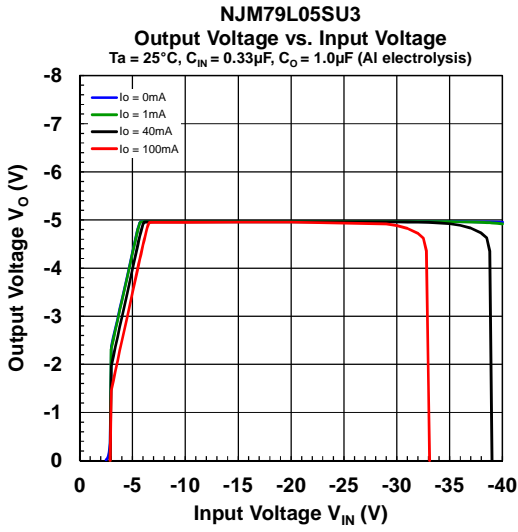

## ■ -5V TYPICAL CHARACTERISTICS

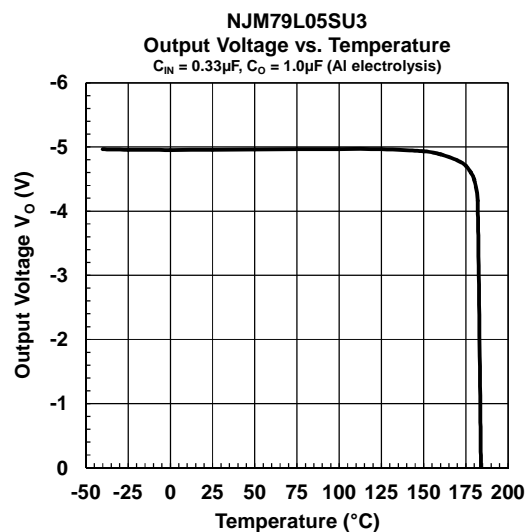
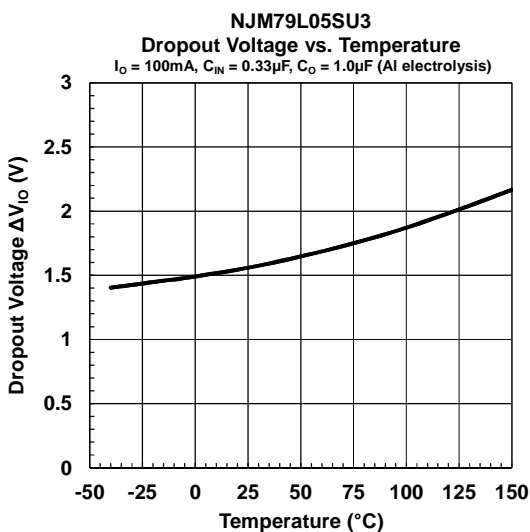
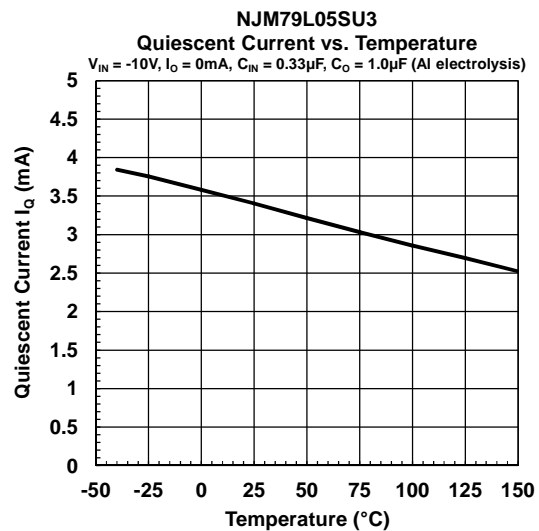
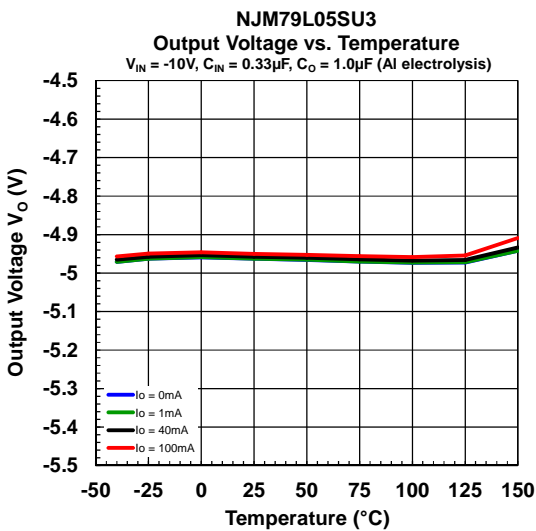
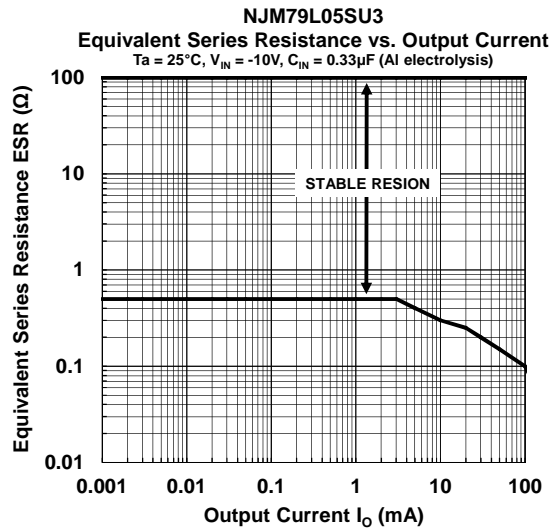
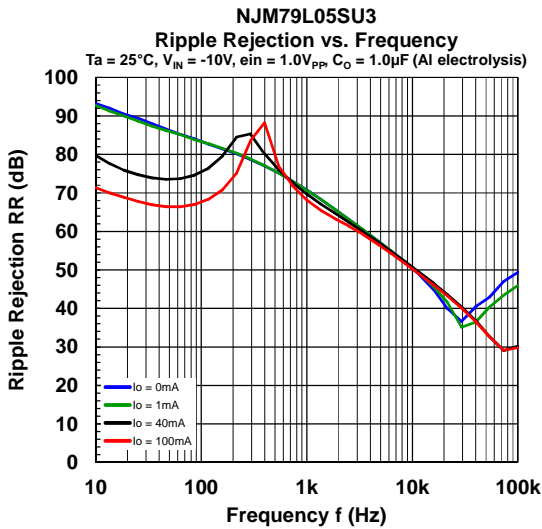

## ■ -6V TYPICAL CHARACTERISTICS

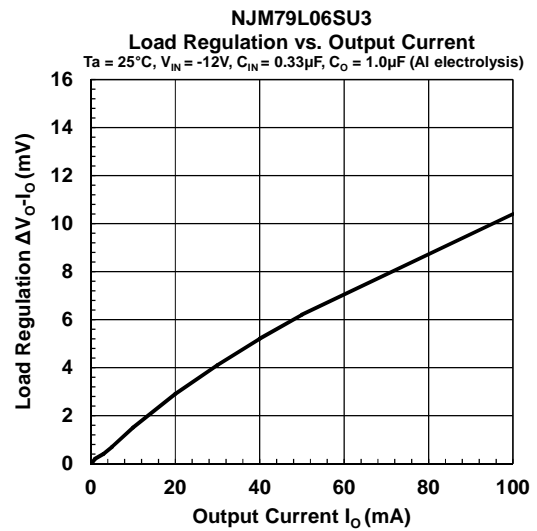
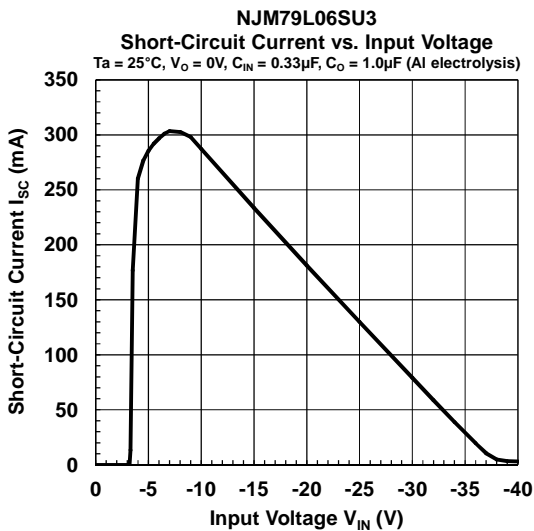
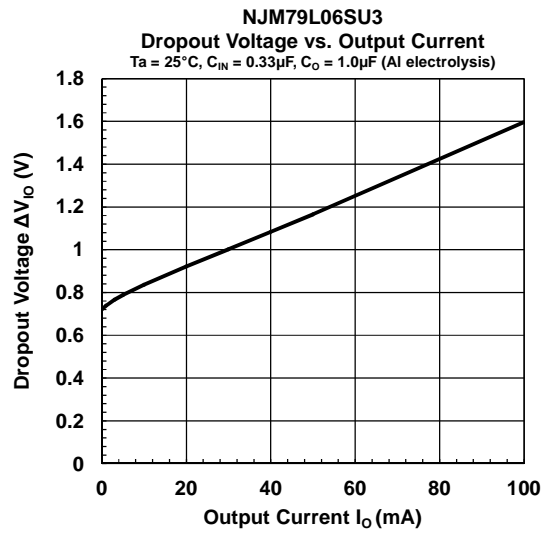
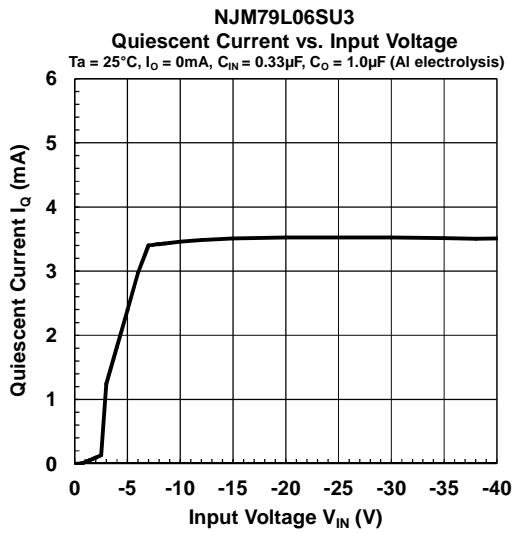
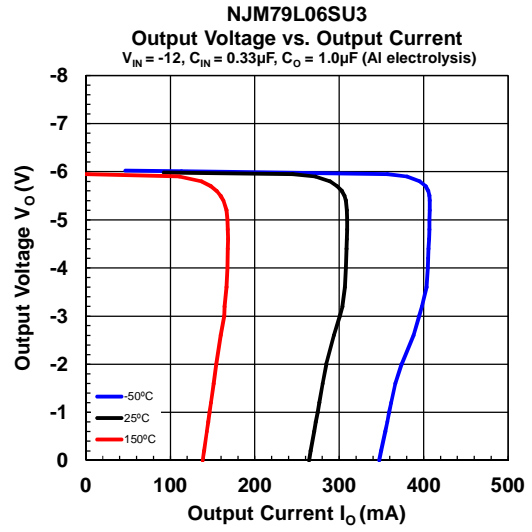
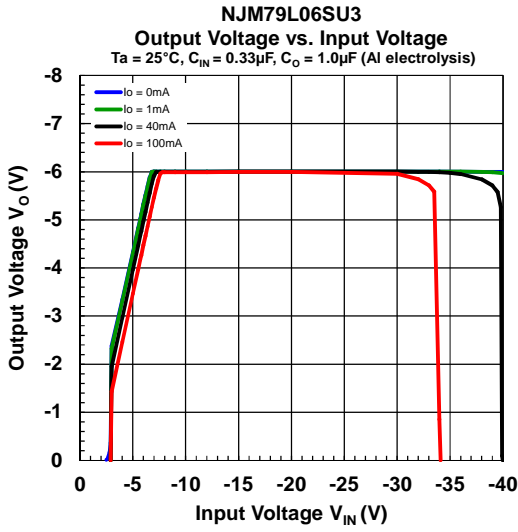

## ■ -6V TYPICAL CHARACTERISTICS

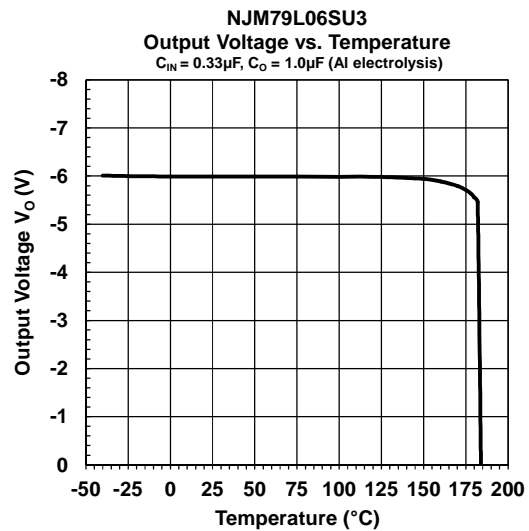
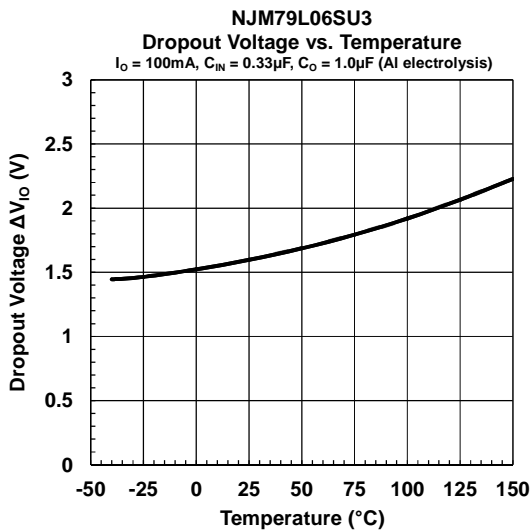
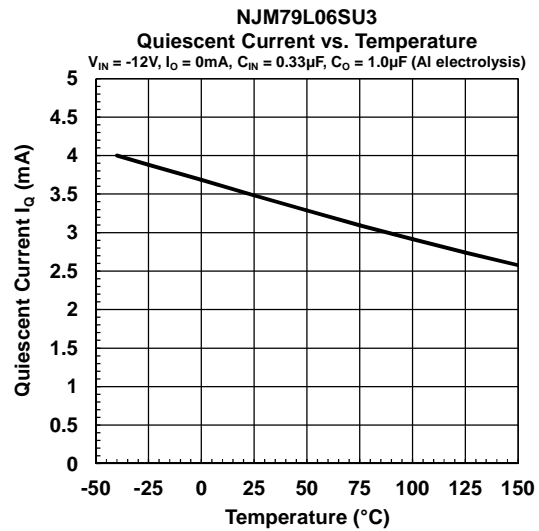
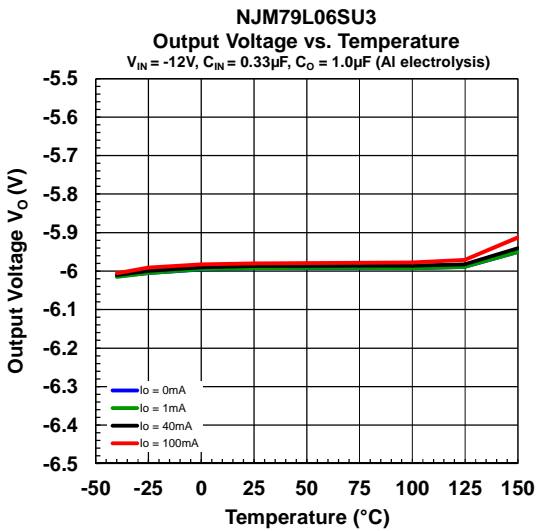
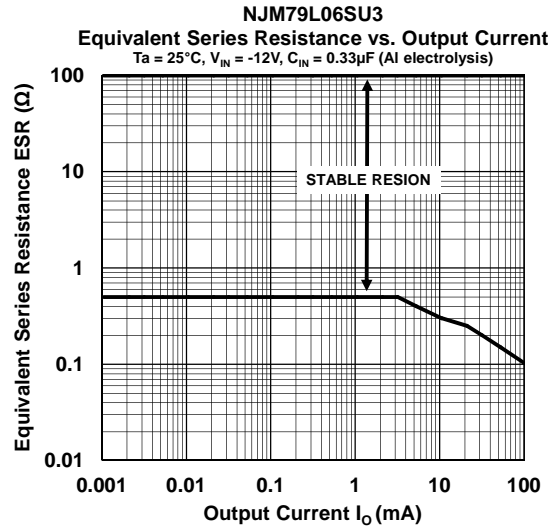
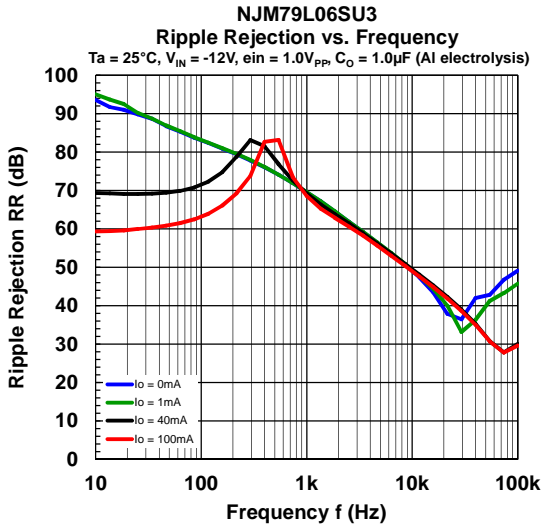



## ■ -8V TYPICAL CHARACTERISTICS

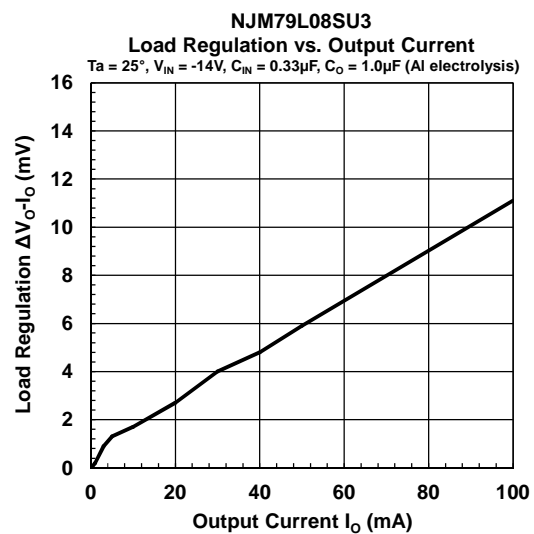
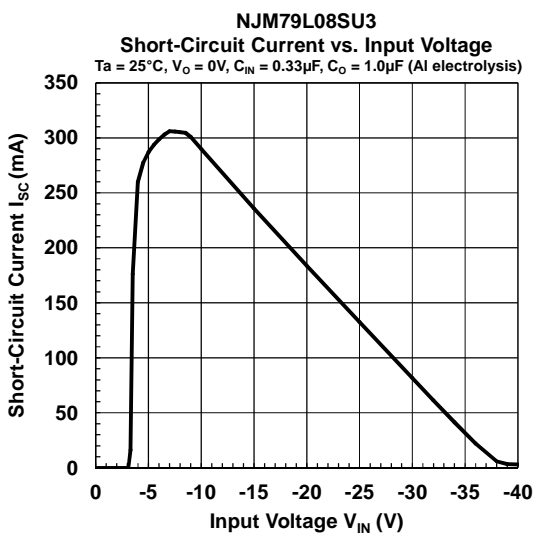
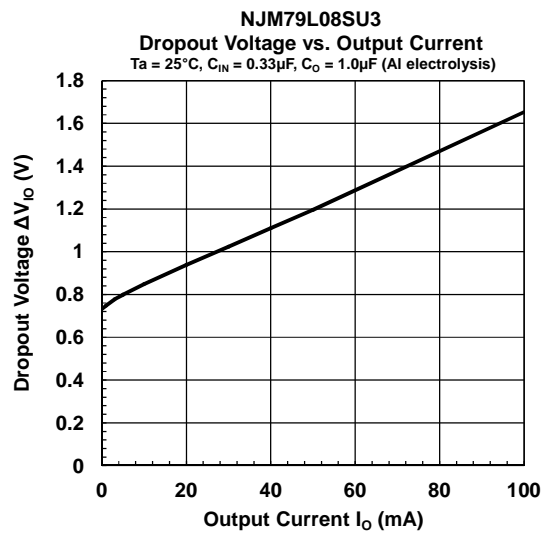
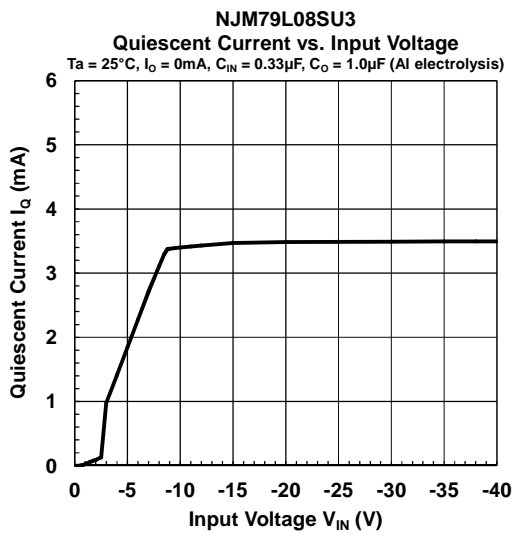
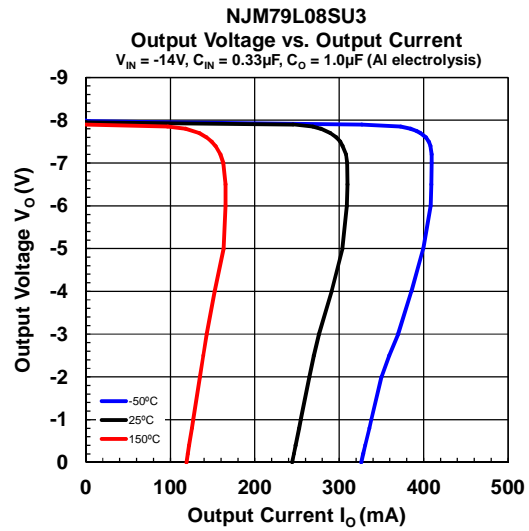
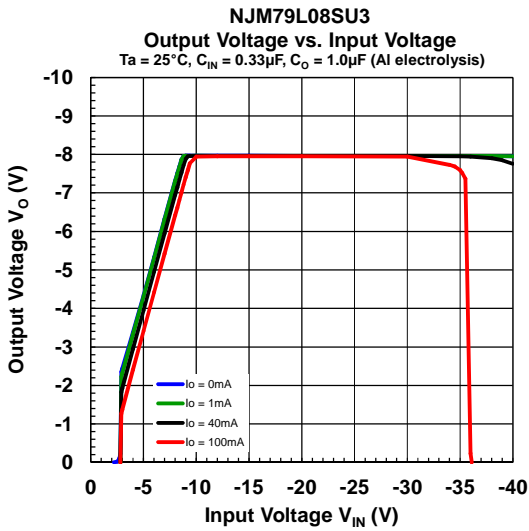

## ■ -8V TYPICAL CHARACTERISTICS

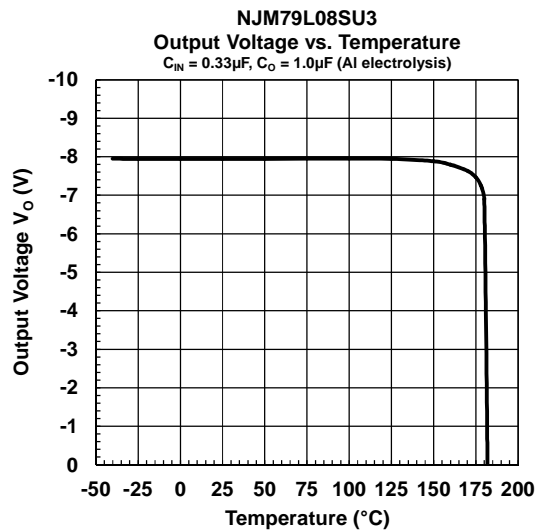
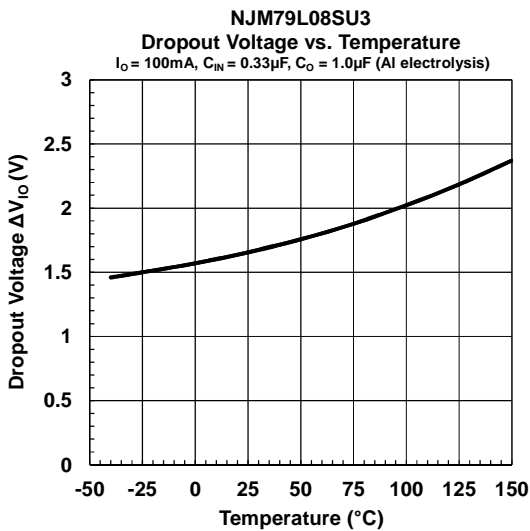
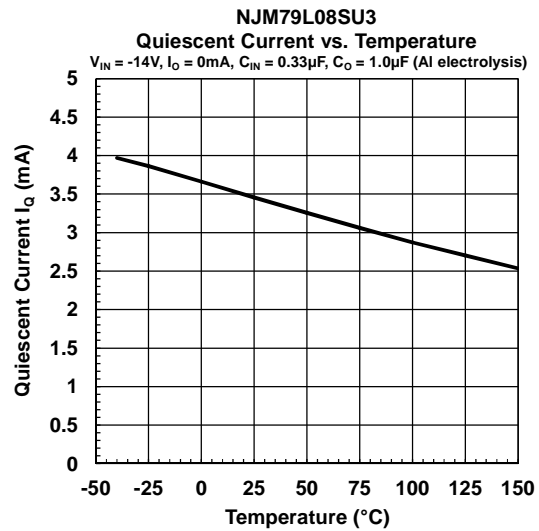
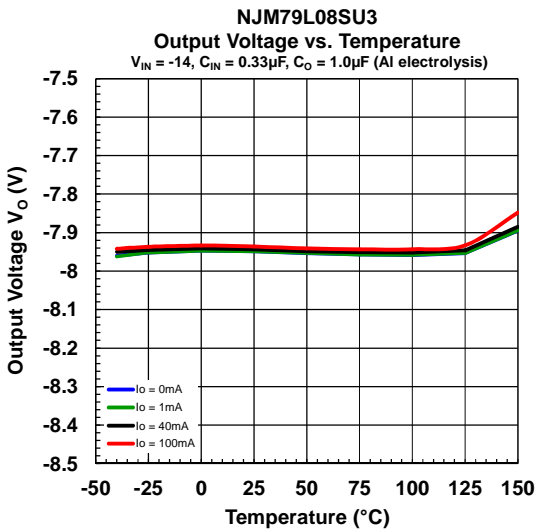
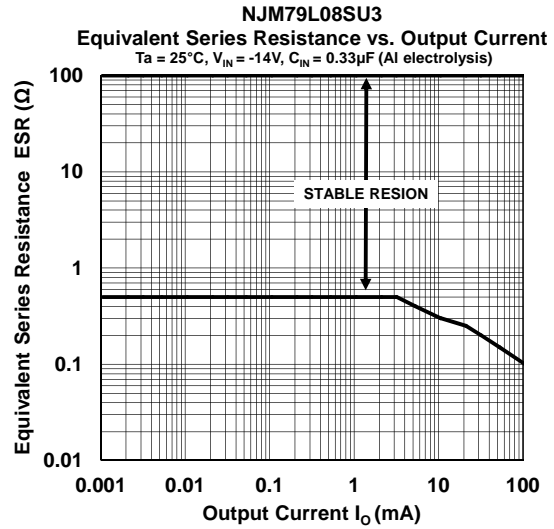
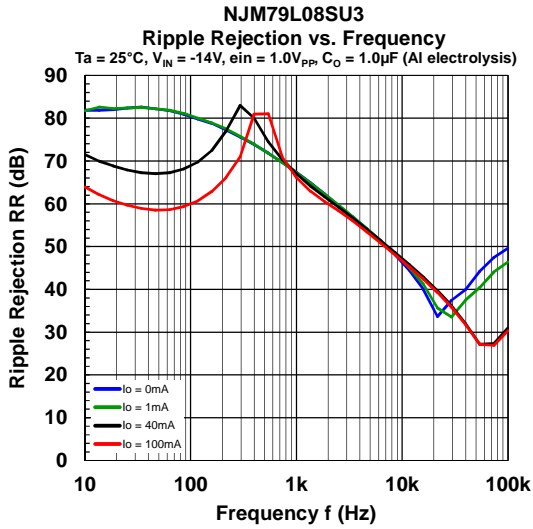

## ■ -9V TYPICAL CHARACTERISTICS

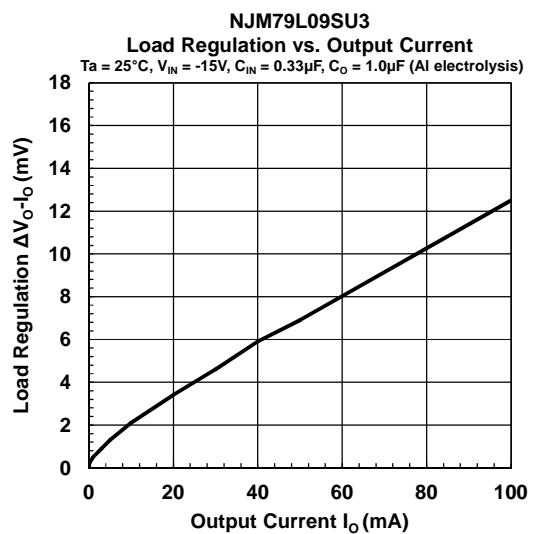
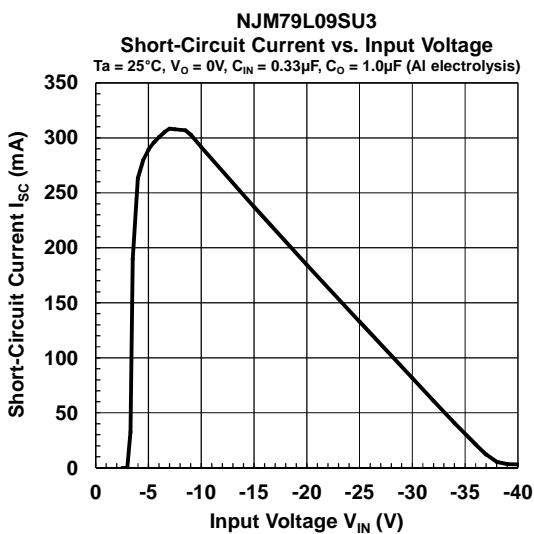
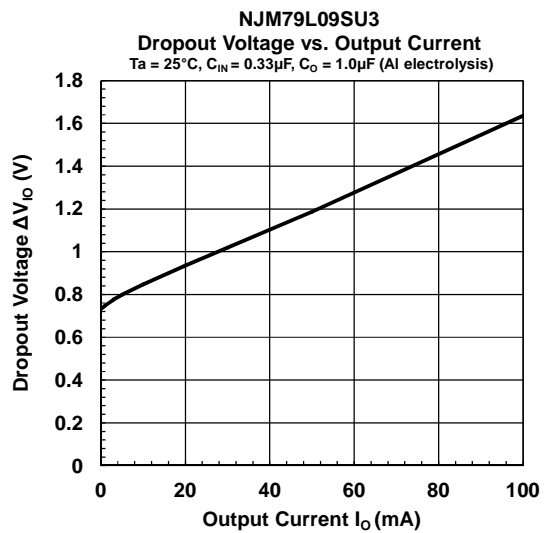
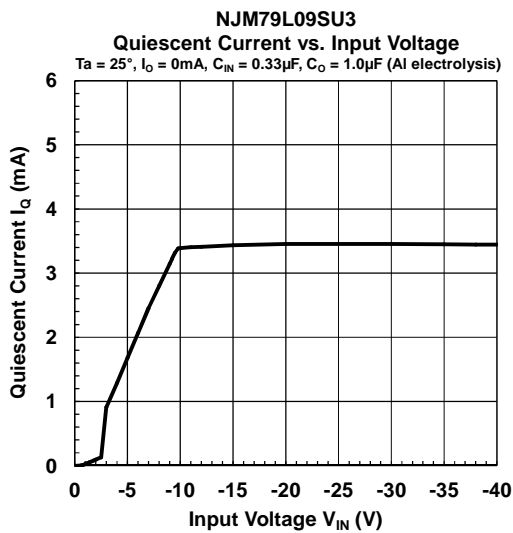
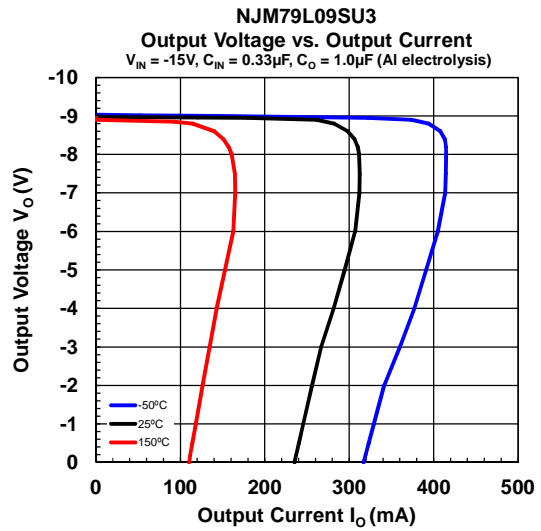
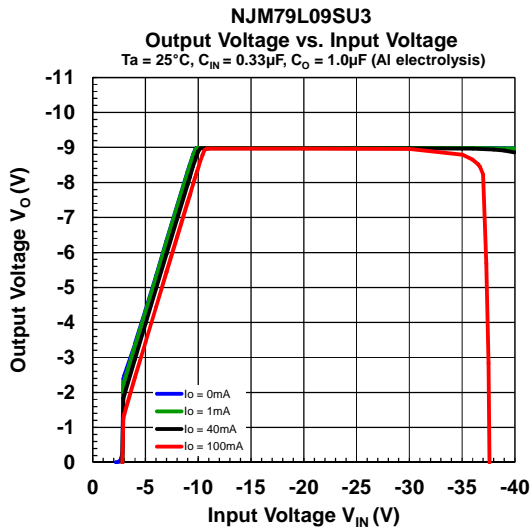

## ■ -9V TYPICAL CHARACTERISTICS

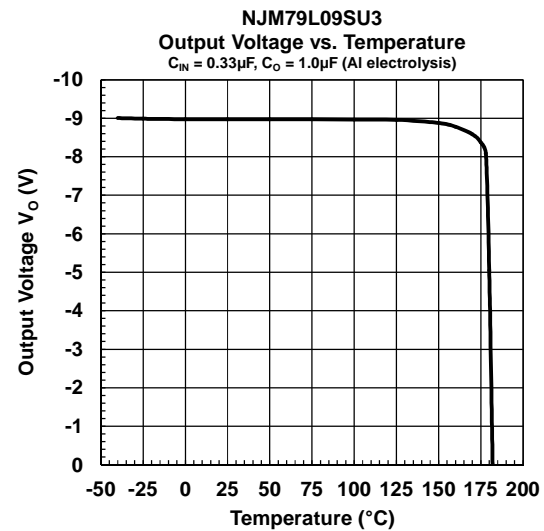
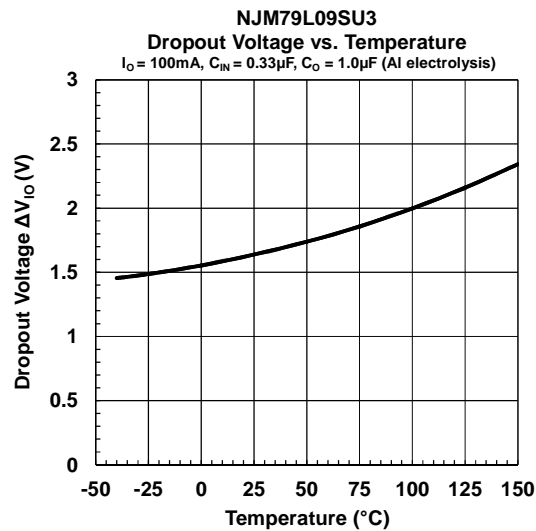
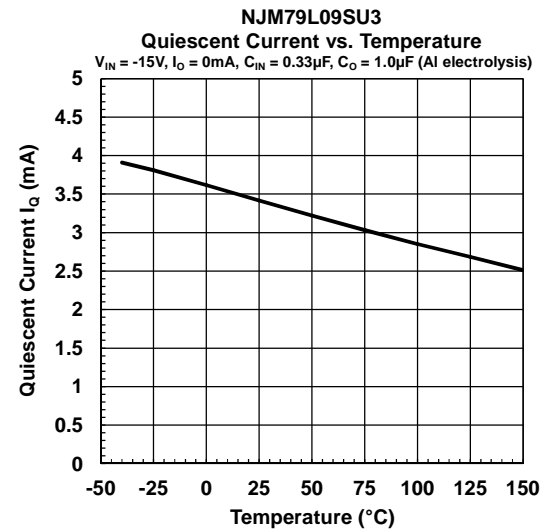
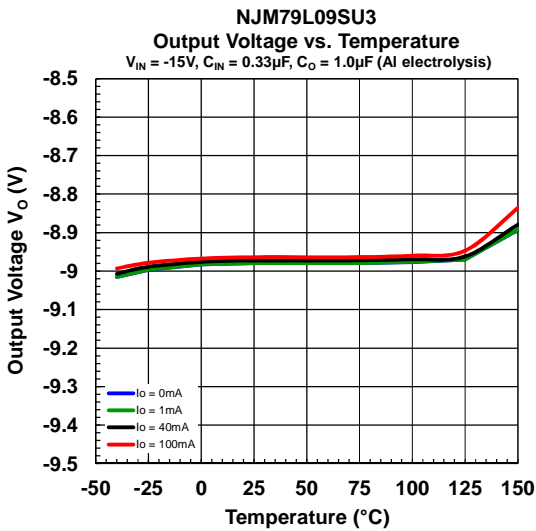
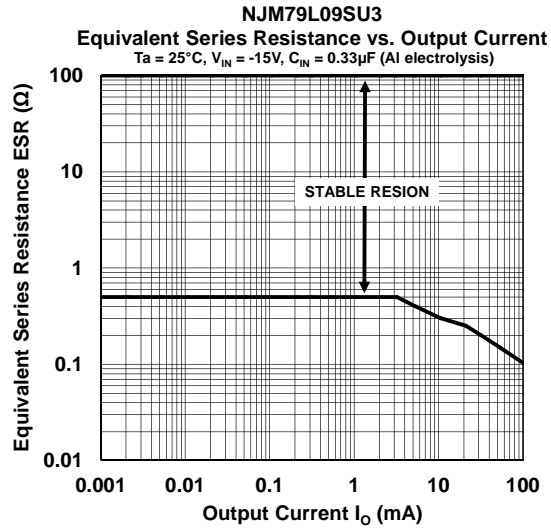
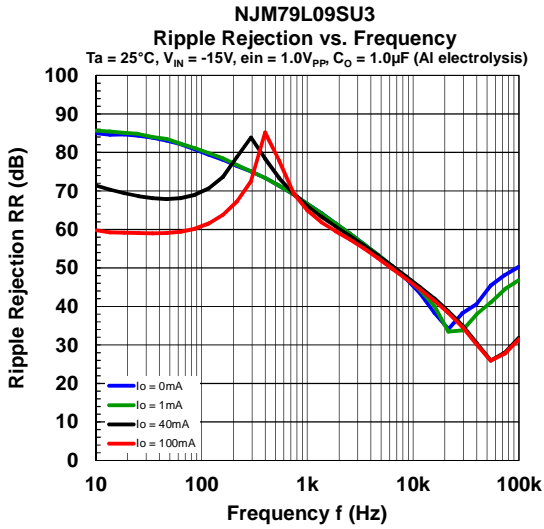

## ■ -12V TYPICAL CHARACTERISTICS

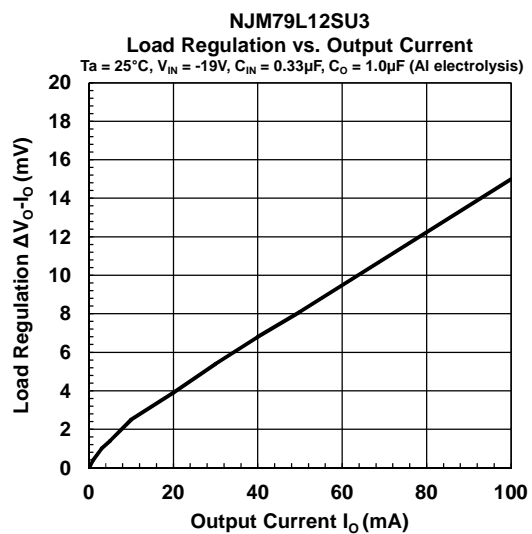
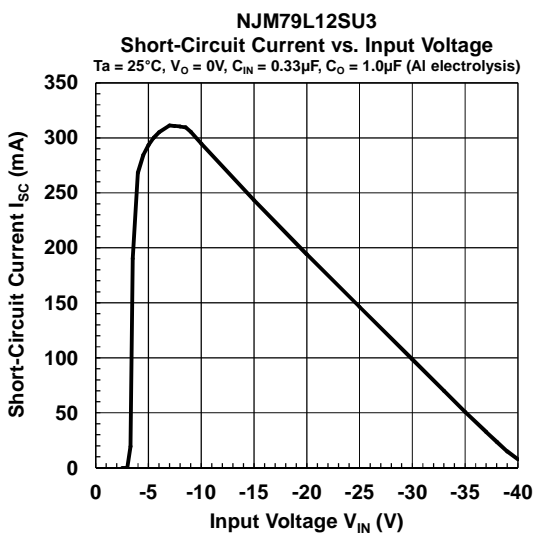
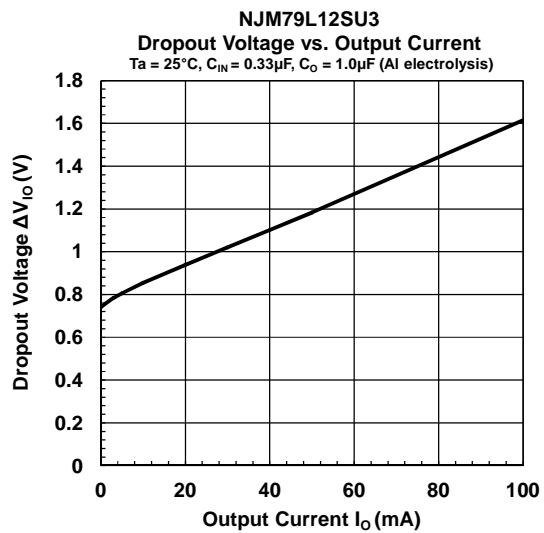
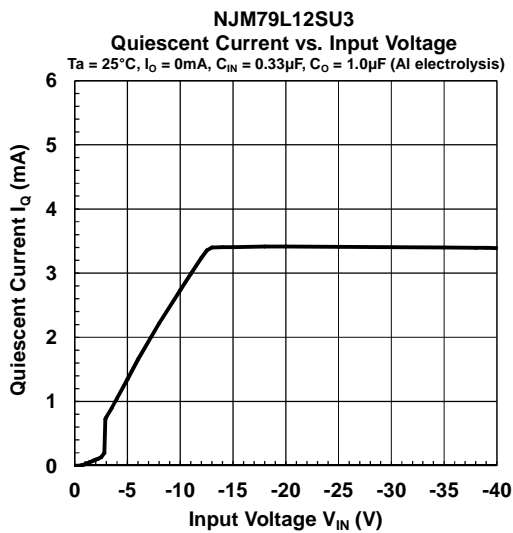
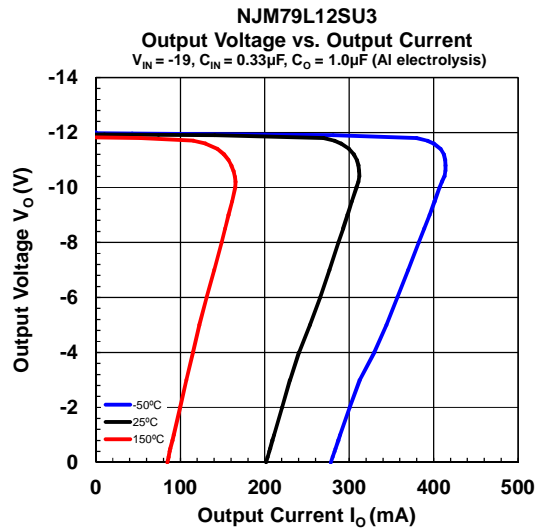
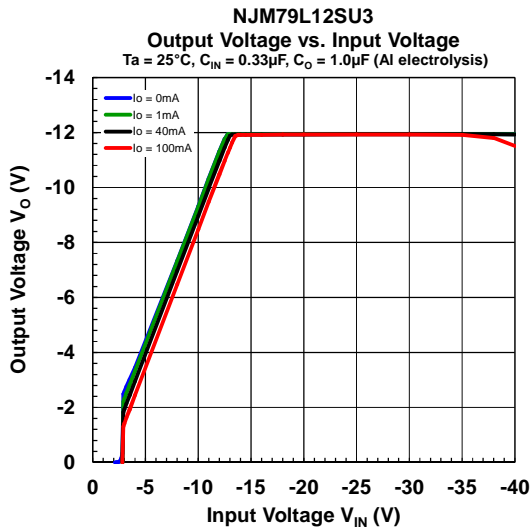

## ■ -12V TYPICAL CHARACTERISTICS

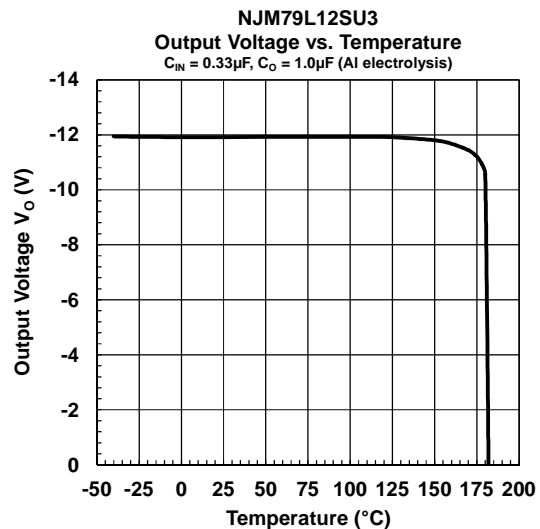
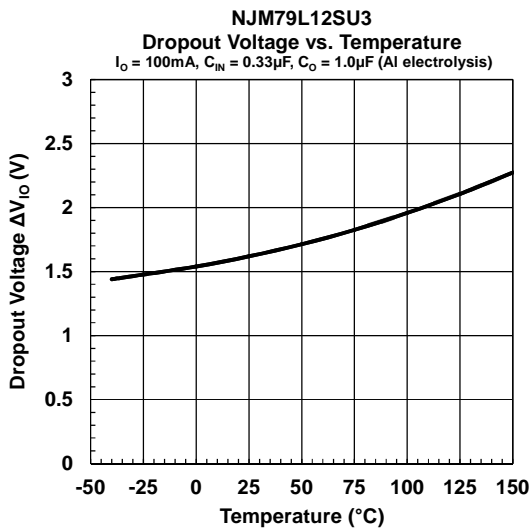
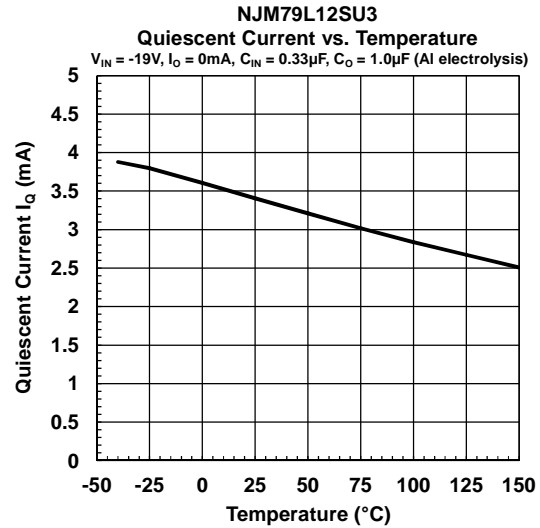
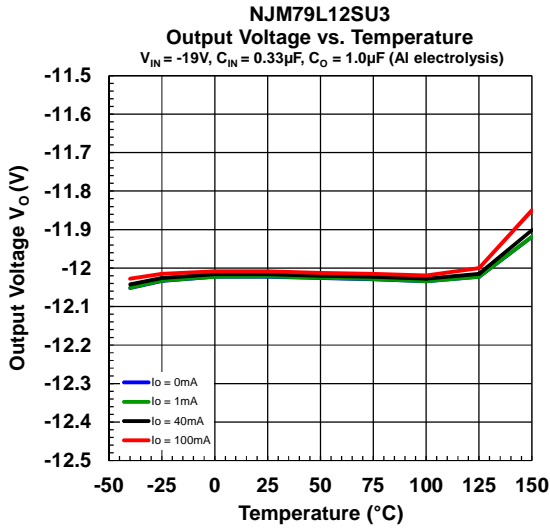
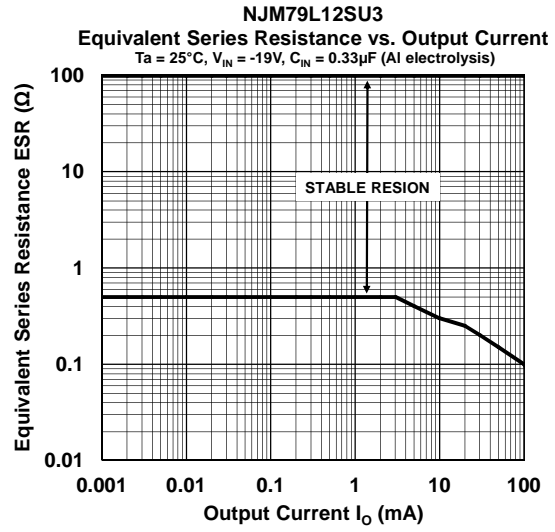
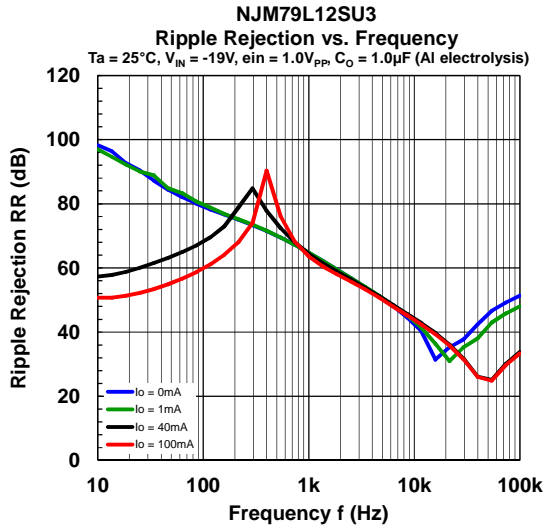

## ■ -15V TYPICAL CHARACTERISTICS

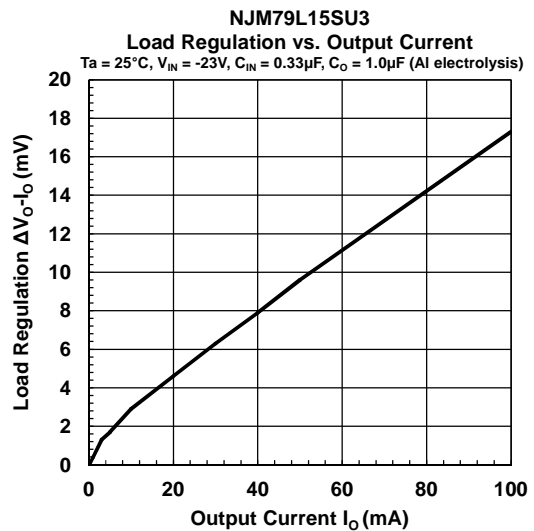
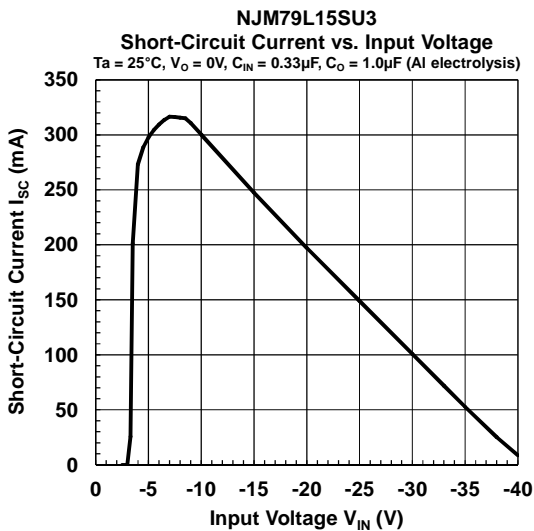
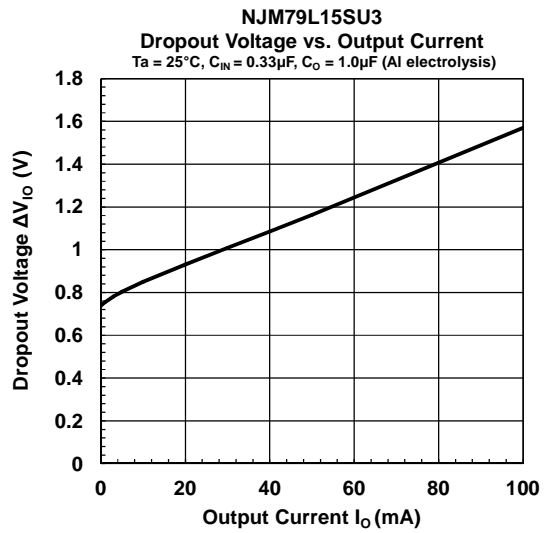
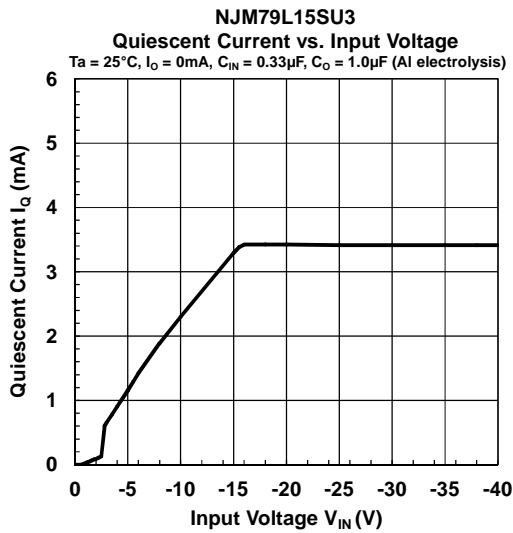
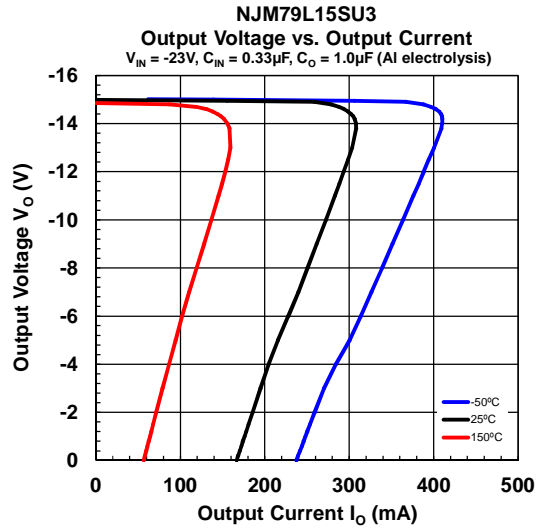
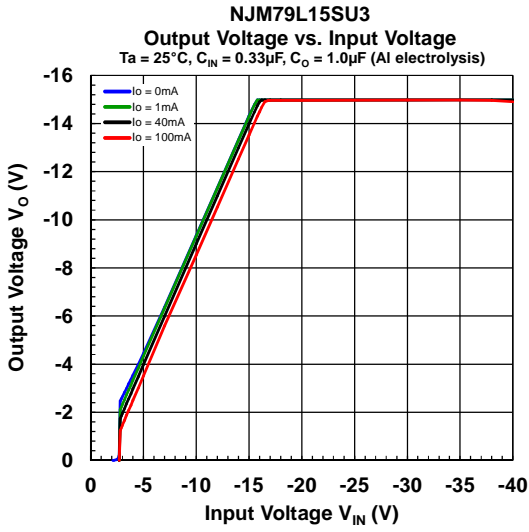

## ■ -15V TYPICAL CHARACTERISTICS

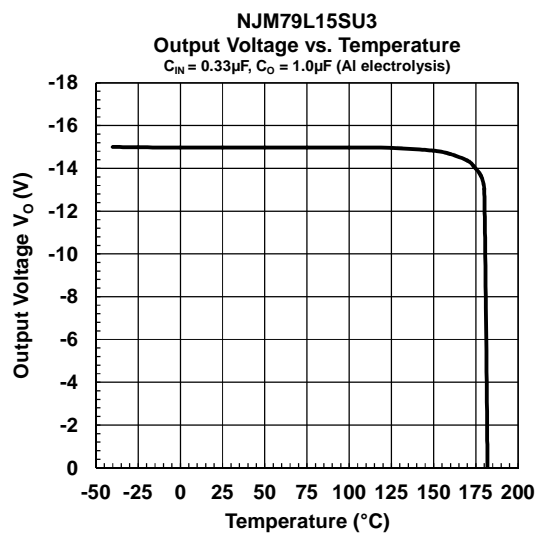
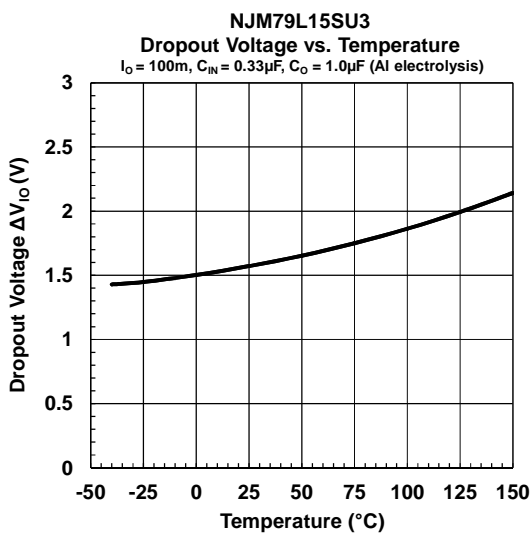
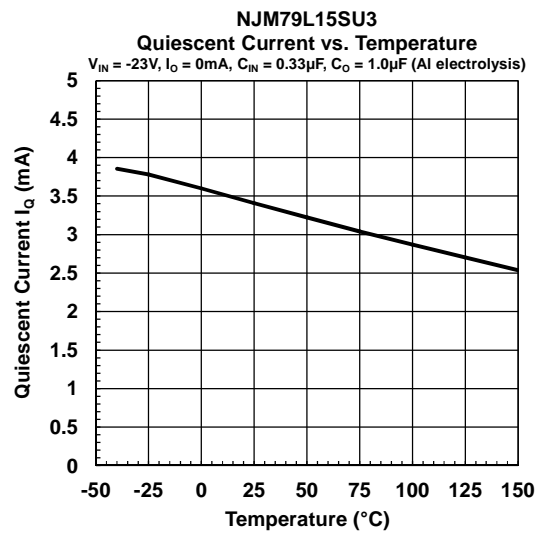
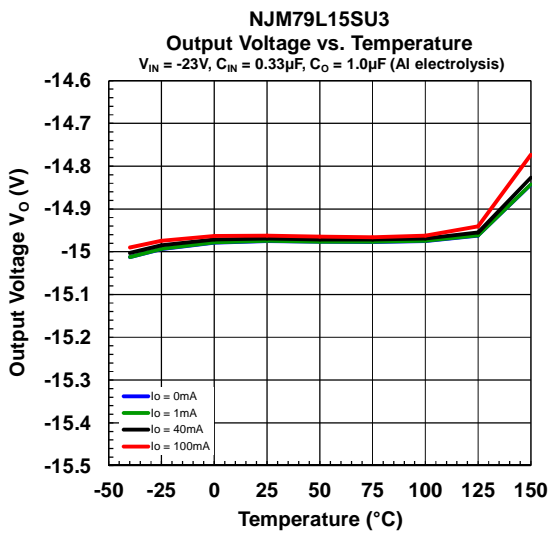
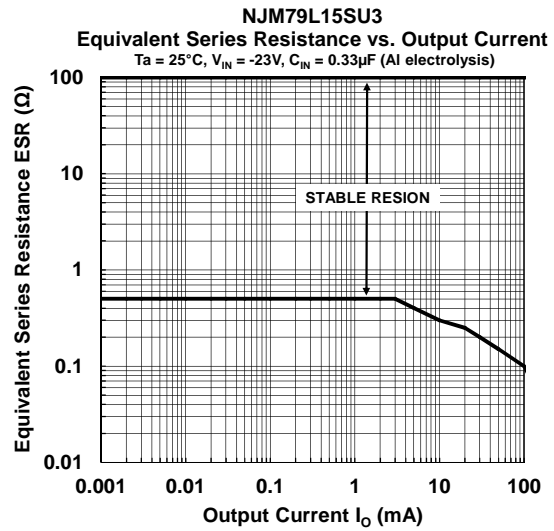
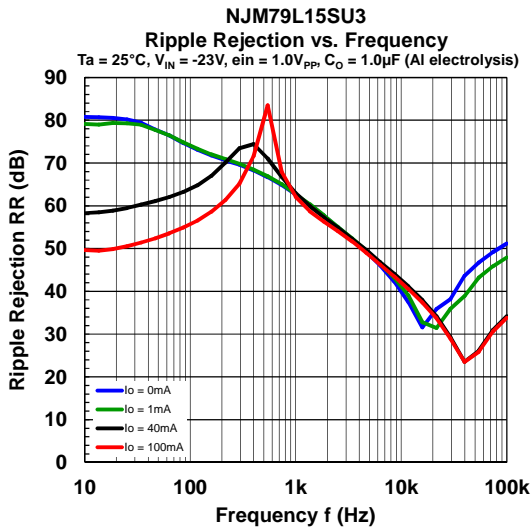



**■ APPLICATION NOTE / GLOSSARY****Input Capacitor ( $C_{IN}$ )**

The  $C_{IN}$  prevents oscillations and reduce power supply ripple of applications when the power supply impedance is high or power supply line is long. Connecting a 0.33  $\mu$ F or larger  $C_{IN}$  between  $V_{IN}$  and GND pins as short path as possible.

**Output Capacitor ( $C_O$ )**

$C_O$  is necessary for phase compensation of the error amplifier built in the regulator, and the capacitance value and ESR (Equivalent Series Resistance) affect the stability of the circuit. If a  $C_O$  with a capacitance value of less than 1.0  $\mu$ F or a  $C_O$  with an ESR characteristic outside the stable area is used, output noise and/or regulator oscillation may occur due to lack of the phase compensation. For stable operation, connect a 1.0  $\mu$ F or larger aluminum electrolytic capacitor with ESR characteristics within the stable operation area between the  $V_{OUT}$  and GND pins as short path as possible. As the capacitance value of  $C_O$  increases, output noise and ripple decrease, and the response to output load fluctuations also improves.

Select the output capacitor considering various characteristics such as frequency characteristics, temperature characteristics, and DC bias characteristics. For the  $C_O$ , a capacitor with excellent temperature characteristics and sufficient margin for output voltage is recommended.

### ■ PACKAGE DIMENSIONS

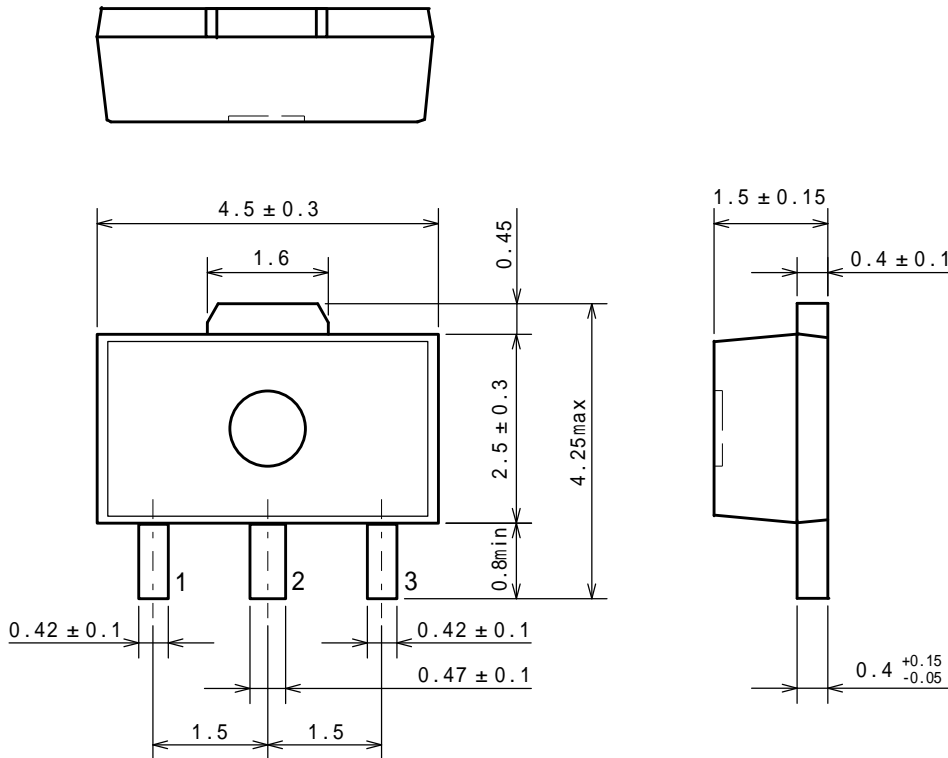

### ■ EXAMPLE OF SOLDER PADS DIMENSIONS

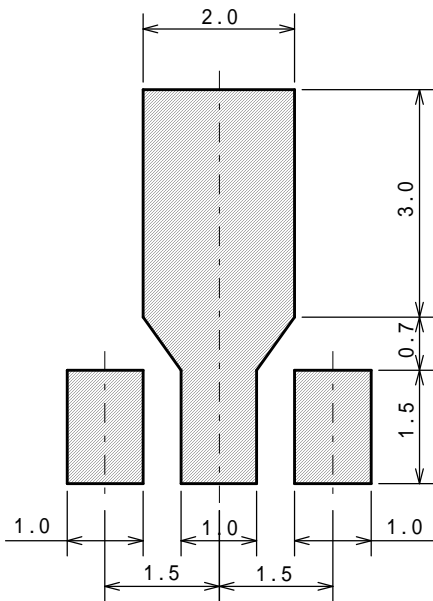

### PACKING SPEC

#### TAPING DIMENSIONS

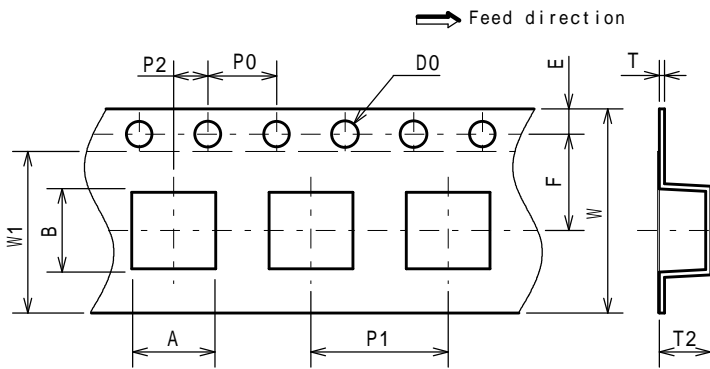

SYMBOL	DIMENSION	REMARKS
A	4.9 ± 0.1	BOTTOM DIMENSION
B	4.5 ± 0.1	BOTTOM DIMENSION
D0	1.5 <sup>+0.1</sup> <sub>0</sub>	
E	1.5 ± 0.1	
F	5.65 ± 0.1	
P0	4.0 ± 0.1	
P1	8.0 ± 0.1	
P2	2.0 ± 0.05	
T	0.3 ± 0.05	
T2	2.0	
W	12.0 ± 0.3	
W1	9.5	THICKNESS 0.1MAX

#### REEL DIMENSIONS

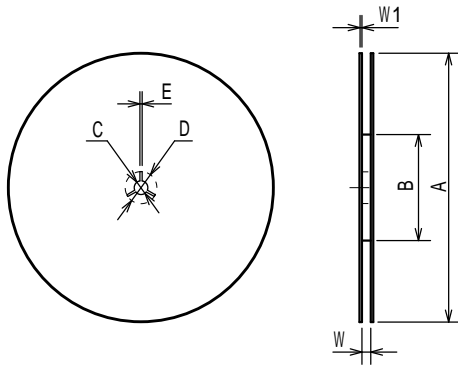

SYMBOL	DIMENSION
A	180 ± 1
B	60 ± 1
C	13 ± 0.2
D	21 ± 0.8
E	2 ± 0.5
W	13 ± 0.5
W1	1.2 ± 0.2

#### TAPING STATE

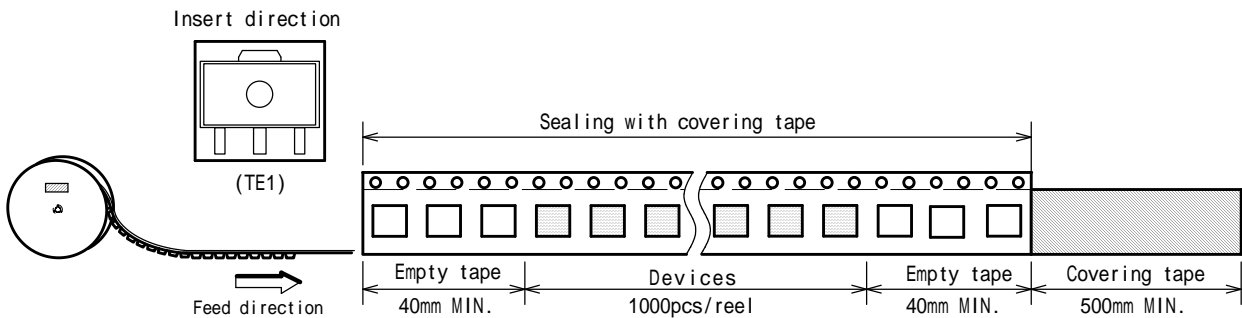

#### PACKING STATE

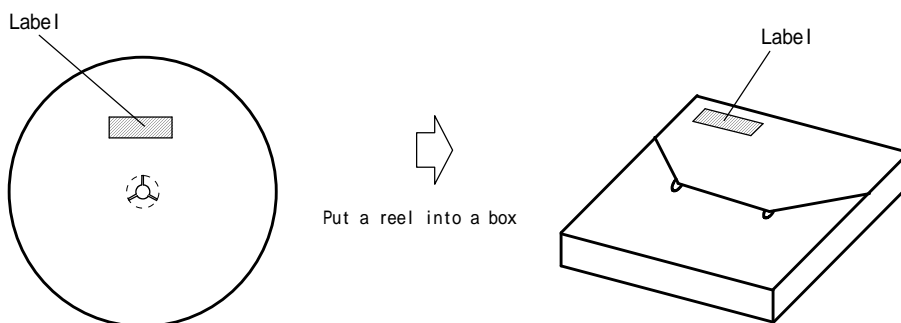

## ■ RECOMMENDED MOUNTING METHOD

### INFRARED REFLOW SOLDERING PROFILE

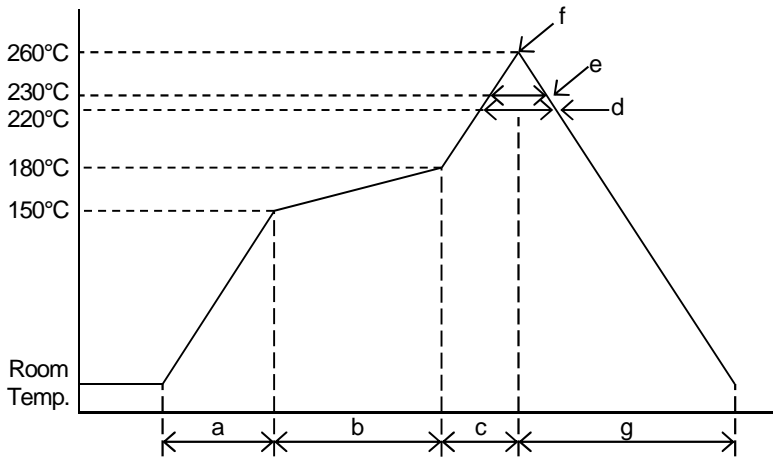

a	Temperature ramping rate	1 to 4°C/s
b	Pre-heating temperature	150 to 180°C
	Pre-heating time	60 to 120s
c	Temperature ramp rate	1 to 4°C/s
d	220°C or higher time	shorter than 60s
e	230°C or higher time	shorter than 40s
f	Peak temperature	lower than 260°C
g	Temperature ramping rate	1 to 6°C/s

The temperature indicates at the surface of mold package.

### FLOW SOLDERING PROFILE

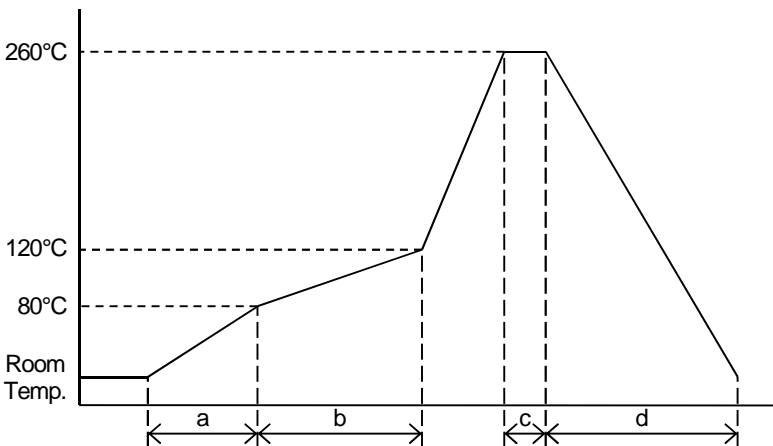

a	Temperature ramping rate	1 to 7°C/s
b	Pre-heating temperature	80 to 120°C
	Pre-heating time	60 to 120s
c	Peak temperature	lower than 260°C
	Peak time	shorter than 10s
d	Temperature ramping rate	1 to 7°C/s

The temperature indicates at the surface of mold package.

## ■ REVISION HISTORY

DATE	REVISION	CHANGES
December 20, 2019	Ver.1.0	Initial release

## [ CAUTION ]

1. NJR strives to produce reliable and high quality semiconductors. NJR's semiconductors are intended for specific applications and require proper maintenance and handling. To enhance the performance and service of NJR's semiconductors, the devices, machinery or equipment into which they are integrated should undergo preventative maintenance and inspection at regularly scheduled intervals. Failure to properly maintain equipment and machinery incorporating these products can result in catastrophic system failures
2. The specifications on this datasheet are only given for information without any guarantee as regards either mistakes or omissions. The application circuits in this datasheet are described only to show representative usages of the product and not intended for the guarantee or permission of any right including the industrial property rights.  
All other trademarks mentioned herein are the property of their respective companies.
3. To ensure the highest levels of reliability, NJR products must always be properly handled.  
The introduction of external contaminants (e.g. dust, oil or cosmetics) can result in failures of semiconductor products.
4. NJR offers a variety of semiconductor products intended for particular applications. It is important that you select the proper component for your intended application. You may contact NJR's Sale's Office if you are uncertain about the products listed in this datasheet.
5. Special care is required in designing devices, machinery or equipment which demand high levels of reliability. This is particularly important when designing critical components or systems whose failure can foreseeably result in situations that could adversely affect health or safety. In designing such critical devices, equipment or machinery, careful consideration should be given to amongst other things, their safety design, fail-safe design, back-up and redundancy systems, and diffusion design.
6. The products listed in this datasheet may not be appropriate for use in certain equipment where reliability is critical or where the products may be subjected to extreme conditions. You should consult our sales office before using the products in any of the following types of equipment.
  - Aerospace Equipment
  - Equipment Used in the Deep Sea
  - Power Generator Control Equipment (Nuclear, steam, hydraulic, etc.)
  - Life Maintenance Medical Equipment
  - Fire Alarms / Intruder Detectors
  - Vehicle Control Equipment (Airplane, railroad, ship, etc.)
  - Various Safety Devices
7. NJR's products have been designed and tested to function within controlled environmental conditions. Do not use products under conditions that deviate from methods or applications specified in this datasheet. Failure to employ the products in the proper applications can lead to deterioration, destruction or failure of the products. NJR shall not be responsible for any bodily injury, fires or accident, property damage or any consequential damages resulting from misuse or misapplication of the products. The products are sold without warranty of any kind, either express or implied, including but not limited to any implied warranty of merchantability or fitness for a particular purpose.
8. Warning for handling Gallium and Arsenic (GaAs) Products (Applying to GaAs MMIC, Photo Reflector). These products use Gallium (Ga) and Arsenic (As) which are specified as poisonous chemicals by law. For the prevention of a hazard, do not burn, destroy, or process chemically to make them as gas or power. When the product is disposed of, please follow the related regulation and do not mix this with general industrial waste or household waste.
9. The product specifications and descriptions listed in this datasheet are subject to change at any time, without notice.



# Mouser Electronics

Authorized Distributor

Click to View Pricing, Inventory, Delivery & Lifecycle Information:

## Nisshinbo Micro Devices:

[NJM79L05UA-TE2](#) [NJM79L12UA-TE2](#) [NJM79L15UA-TE2](#) [NJM79L12UA-TE1](#) [NJM79L05UA-TE1](#) [NJM79L03UA-TE1](#) [NJM79L05A](#) [NJM79L05A-T1](#) [NJM79L05A-T3](#) [NJM79L05A-T2](#) [NJM79L08UA-TE1](#) [NJM79L08UA-TE2](#) [NJM79L09UA-TE1](#) [NJM79L15UA-TE1](#) [NJM79L05SU3-TE1](#) [NJM79L06SU3-TE1](#) [NJM79L08SU3-TE1](#) [NJM79L09SU3-TE1](#) [NJM79L12SU3-TE1](#) [NJM79L15SU3-TE1](#) [NJM79L03UATE1](#)